



This is a digital copy of a book that was preserved for generations on library shelves before it was carefully scanned by Google as part of a project to make the world's books discoverable online.

It has survived long enough for the copyright to expire and the book to enter the public domain. A public domain book is one that was never subject to copyright or whose legal copyright term has expired. Whether a book is in the public domain may vary country to country. Public domain books are our gateways to the past, representing a wealth of history, culture and knowledge that's often difficult to discover.

Marks, notations and other marginalia present in the original volume will appear in this file - a reminder of this book's long journey from the publisher to a library and finally to you.

Usage guidelines

Google is proud to partner with libraries to digitize public domain materials and make them widely accessible. Public domain books belong to the public and we are merely their custodians. Nevertheless, this work is expensive, so in order to keep providing this resource, we have taken steps to prevent abuse by commercial parties, including placing technical restrictions on automated querying.

We also ask that you:

- + *Make non-commercial use of the files* We designed Google Book Search for use by individuals, and we request that you use these files for personal, non-commercial purposes.
- + *Refrain from automated querying* Do not send automated queries of any sort to Google's system: If you are conducting research on machine translation, optical character recognition or other areas where access to a large amount of text is helpful, please contact us. We encourage the use of public domain materials for these purposes and may be able to help.
- + *Maintain attribution* The Google "watermark" you see on each file is essential for informing people about this project and helping them find additional materials through Google Book Search. Please do not remove it.
- + *Keep it legal* Whatever your use, remember that you are responsible for ensuring that what you are doing is legal. Do not assume that just because we believe a book is in the public domain for users in the United States, that the work is also in the public domain for users in other countries. Whether a book is still in copyright varies from country to country, and we can't offer guidance on whether any specific use of any specific book is allowed. Please do not assume that a book's appearance in Google Book Search means it can be used in any manner anywhere in the world. Copyright infringement liability can be quite severe.

About Google Book Search

Google's mission is to organize the world's information and to make it universally accessible and useful. Google Book Search helps readers discover the world's books while helping authors and publishers reach new audiences. You can search through the full text of this book on the web at <http://books.google.com/>

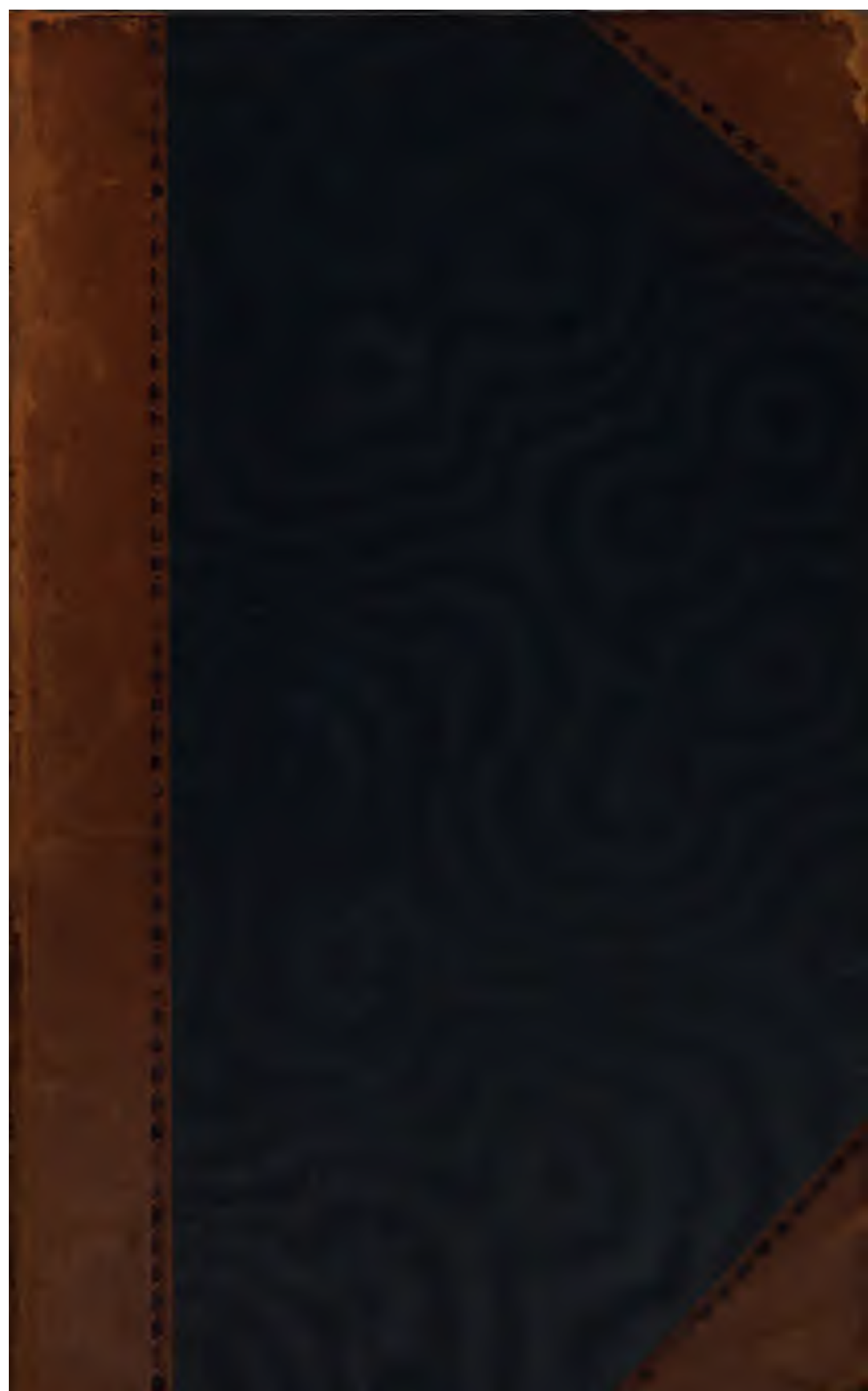

38.

791.





38.

791.

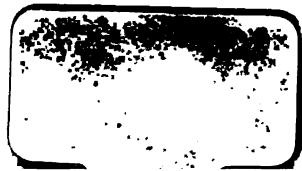



**ARBORETUM ET FRUTICETUM
BRITANNICUM;**

OR,

**THE TREES AND SHRUBS OF BRITAIN,
Native and Foreign, Hardy and Half-Hardy,
PICTORIALLY AND BOTANICALLY DELINEATED,
AND SCIENTIFICALLY AND POPULARLY DESCRIBED;**

WITH

**THEIR PROPAGATION, CULTURE, MANAGEMENT,
AND USES IN THE ARTS, IN USEFUL AND ORNAMENTAL PLANTATIONS, AND IN
LANDSCAPE-GARDENING;**

PRECEDED BY A

**HISTORICAL AND GEOGRAPHICAL OUTLINE
OF THE TREES AND SHRUBS OF TEMPERATE CLIMATES
THROUGHOUT THE WORLD.**

By J. C. LOUDON, F.L. & H.S., &c.

**AUTHOR OF THE ENCYCLOPÆDIAS OF GARDENING AND OF AGRICULTURE,
AND CONDUCTOR OF THE GARDENER'S MAGAZINE.**



IN EIGHT VOLUMES:

**FOUR OF LETTERPRESS, ILLUSTRATED BY ABOVE 2500 ENGRAVINGS,
AND FOUR OF OCTAVO AND QUARTO PLATES.**

VOL. IV.

FROM GARRY'S CELE, P. 2031., TO THE END.

LONDON:

PRINTED FOR THE AUTHOR;

AND SOLD BY

LONGMAN, ORME, BROWN, GREEN, AND LONGMANS;

**THE PARTIALLY COLOURED AND COLOURED COPIES, BY
JAMES RIDGWAY AND SONS.**

1838.

791.

LONDON:
Printed by A. SPOTTISWOOD,
New-Street-Square.

CONTENTS OF VOL. IV.

The Roman numerals refer to the General Table of Contents, Vol. I. p. xvii. to clix., where the species and varieties, with all their synonymes, will be found systematically arranged; the first column of Arabic figures, to the pages of the text in this volume; and the second, to those of the supplementary matter at the end of it.

The names of the half-hardy and suffruticose orders and genera are in small type.

	I.	IV.	IV.		I.	IV.	IV.
<i>Garryàcæe.</i> -	cxxxii.	2031		<i>Cèdrus Barrel.</i> -	cxl.	2402	2603
<i>Garrya</i> -	cxxxii.	2031		<i>Cedar.</i>			
				<i>Araucària R. et P.</i> -	cxl.	2432	2603
				<i>Chili Pine.</i>			
<i>Platanàcæe.</i> -	cxxxii.	2032	2596	<i>Cunninghàmia R. Br.</i>	cxl.	2445	
<i>Platanus</i> -	cxxxii.	2033	2596	<i>Chinese Fir.</i>			
<i>Plane Tree.</i>				<i>Dàmbara Rumph.</i> -	cxl.	2447	2603
				<i>Dammara.</i>			
				<i>Amboyna Pine.</i>			
<i>Balsamàcæe.</i> -	cxxxii.	2048	2597	CUPRE'SSINÆ.	cxl.	2453	2605
<i>Liquidámbar L.</i> -	cxxxii.	2049	2597	<i>Thùja L.</i> -	cxl.	2454	
				<i>Arbor Vite.</i>			
<i>Myricàcæe.</i> -	cxxxii.	2045	2597	<i>Cállitris Vent.</i> -	cxli.	2462	
<i>Myrica L.</i> -	cxxxii.	2055	2597	<i>Cupréssus L.</i> -	cxli.	2464	2605
<i>Candleberry Myrtle.</i>				<i>Cypress.</i>			
<i>Comptònia Banks</i> -	cxxxii.	2059		<i>Taxòdium</i> -	cxlii.	2480	
				<i>Deciduous Cypress.</i>			
<i>Casuaràcæe.</i> -	cxxxii.	2060		<i>Juníperus L.</i> -	cxlii.	2487	2605
<i>Casuarina</i> -	cxxxii.	2060		<i>Juniper.</i>			
<i>Gnetàcæe</i> -	cxxxiii.	2062	2597	<i>Empetràcæe.</i> -	cxliii.	2506	
<i>Ephedra L.</i> -	cxxxiii.	2062	2597	<i>E'mpetrum L.</i> -	cxliii.	2506	
<i>Horse Tail.</i>				<i>Crowberry.</i>			
<i>Taxàcæe.</i> -	cxxxiii.	2065	2597	<i>Corèma D. Don</i> -	cxliiii.	2508	
<i>Taxus L.</i> -	cxxxiii.	2066	2597	<i>Ceratiola Mx.</i> -	cxliiii.	2508	
<i>Yew Tree.</i>							
<i>Salisbùria Sm.</i> -	cxxxiii.	2094		<i>Smilàcæe.</i> -	cxliiii.	2509	
<i>Ginkgo.</i>				<i>Smilax L.</i> -	cxliiii.	2510	
<i>Fedocètypus L.</i> -	cxxxiii.	2100					
<i>Dacrydium Sol.</i> -	cxxxiii.	2100		<i>Liliàcæe.</i> -	cxliv.	2515	
<i>Phylloclada</i> -	cxxxiii.	2100	2579	<i>Aspàragus L.</i> -	cxliv.	2516	
				<i>Rúscus L.</i> -	cxliv.	2517	
<i>Coniferae, or Pi- } nàcæe.</i> - }	cxxxiii.	2103	2597	<i>Butcher's Broom.</i>			
<i>ABK'TINÆ.</i>	cxxxiii.	2106	2597	<i>Yúcca L.</i> -	cxlv.	2521	
<i>Pinus L.</i> -	cxxxiii.	2152	2597	<i>Adam's Needle.</i>			
<i>Pine.</i>				<i>Monocotyledòneæ.</i>	cxlv.	2527	
<i>A'bies D. Don</i> -	cxxxvii.	2298	2599	<i>Fourcroya Karw. et Zucc.</i> -	cxlv.	2527	
<i>Spruce Fir.</i>				<i>Litsea's Brig.</i> -	cxlv.	2528	
<i>Picea D. Don</i> -	cxxxviii.	2329	2601	<i>Aghave L.</i> -	cxlv.	2529	2605
<i>Silver Fir.</i>				<i>American Aloe.</i>			
<i>Làrix Turan.</i> -	cxxxix.	2350	2602	<i>Phòrmium</i> -	cxlv.	2529	
<i>Larch.</i>				<i>New Zealand Flax.</i>			
				<i>Chamaerops L.</i> -	cxlv.	2530	
				<i>Dwarf Fan Palm.</i>			
				<i>Bambusa</i> -	cxlv.	2532	
				<i>Bambo.</i>			
				<i>Arundo</i> -	cxlv.	2532	

SUPPLEMENT.

Only the names of those genera are given, under which a new species or variety is introduced.
New genera are distinguished by the sign of addition, thus +; and generic names which have been altered, by parallel lines, thus †.

Part I. OF THE HISTORY AND STUDY OF GEOGRAPHY	-	-	cx.	2533		
Part II. OF THE SCIENCE OF THE STUDY OF TREES	-	-	cx.	2534		
Part III. ARBORETUM AND FRUTICETUM BRITANNICUM.						
		I.	IV.		I.	IV.
<i>Clematidææ.</i>	-	cxlvi.	2534	<i>Xanthoxylææ.</i>	cxlvii.	2545
<i>Clematis</i>	-	cxlvi.	2535	<i>Coriæææ.</i>	cxlvii.	2545
<i>Pæoniæææ.</i>	-	cxlvi.	2535	<i>Celastræææ.</i>	cxlvii.	2545
<i>Magnoliæææ.</i>	-	cxlvi.	2536	<i>Euonymus</i>	-	cxlvii.
<i>Anonæææ.</i>	-	cxlvi.	2536	<i>Aquifoliæææ.</i>	cxlvii.	2546
<i>Berberæææ.</i>	-	cxlvi.	2536	<i>Ilex L.</i>	-	cxlvii.
<i>Berberis</i>	-	cxlvi.	2537	<i>Rhamnæææ.</i>	cxlvii.	2546
+ <i>Nandina</i>	-	cxlvi.	2537	<i>Paliurus</i>	-	cxlvii.
<i>Cruciæææ.</i>	-	cxlvi.	2538	<i>Rhamnus</i>	-	cxlvii.
<i>Cistæææ.</i>	-	cxlvi.	2538	<i>Ceanothus</i>	-	cxlvii.
<i>Polygalæææ.</i>	-	cxlvi.	2538	<i>Anacardiæææ.</i>	cxlvii.	2548
<i>Malvæææ.</i>	-	cxlvi.	2538	<i>Rhus</i>	-	cxlvii.
<i>Málva</i>	-	cxlvi.	2538	<i>Legumindææ.</i>	cxlviii.	2549
<i>Tiliæææ.</i>	-	cxlvi.	2538	<i>SOPHORA'ÆÆÆ.</i>	cxlviii.	2549
<i>Ternströmiæææ.</i>	cxlvi.	2540	+ <i>Euphonia</i>	cxlviii.	2549	
<i>Aurantiæææ.</i>	-	cxlvi.	2540	+ <i>Anacysis</i>	cxlviii.	2549
<i>Hypericæææ.</i>	-	cxlvi.	2541	<i>LO'YERÆÆ.</i>	cxlviii.	2549
<i>Hypéricum</i>	-	cxlvii.	2541	<i>Spártium</i>	-	cxlviii.
<i>Aceræææ.</i>	-	cxlvii.	2541	<i>Genista</i>	-	cxlviii.
<i>Acer</i>	-	cxlvii.	2542	<i>Cytisus</i>	-	cxlviii.
<i>Æsculæææ.</i>	-	cxlvii.	2543	<i>HEDYSA'ÆÆÆ.</i>	cxlviii.	2552
<i>Vitæææ.</i>	-	cxlvii.	2544	<i>Desmodium</i>	-	cxlviii.
<i>Rutæææ.</i>	-	cxlvii.	2544	<i>PHASEOL'ÆÆÆ.</i>	cxlviii.	2553
<i>Ruta</i>	-	cxlvii.	2544	<i>Kassidyæ</i>	cxlviii.	2554
+ <i>Correa Sm.</i>	-	cxlvii.	2544	<i>CASINÆÆ.</i>	cxlviii.	2554
+ <i>Cedrus Sm.</i>	-	cxlvii.	2544	+ <i>Polestibus Dec.</i>	cxlviii.	2558
+ <i>Berberis Sm.</i>	-	cxlvii.	2544	<i>Rosæææ.</i>	cxlviii.	2554
+ <i>Berberis Sm.</i>	-	cxlvii.	2544	<i>AMYGDAL'ÆÆÆ.</i>	cxlviii.	2554
				<i>Armeniaca</i>	-	cxlviii.
				<i>SPIRÆÆÆÆ.</i>	cxlviii.	2555
				<i>Spiræa</i>	-	cxlviii.
				<i>POTENTILLÆÆÆ.</i>	cxlviii.	2557
				+ <i>Cowanis D. Don</i>	cxlix.	2557

CONTENTS OF VOL. IV.

v

	I.	IV.		I.	IV.
<i>Rosa</i>	cxlix.	2558	<i>Epigæ'a</i>	cli.	2575
<i>Crataegus</i>	cxlix.	2559	+ <i>Cyrtia</i>	cli.	2577
<i>Stranvæ'sia</i>	cxlix.	2563	<i>Myrsinææ.</i>	cli.	2578
<i>Cotoneaster</i>	cxlix.	2563	<i>Myrsine</i>	cli.	2578
<i>Pyrus</i>	cxlix.	2565	<i>Sapotææ.</i>	cli.	2578
<i>Chimonanthus</i>	cxlix.	2566	<i>Ebenææ.</i>	cli.	2578
<i>Granatææ.</i>	cxlix.	2566	<i>Diospÿros</i>	cli.	2578
<i>Onagrææ.</i>	cxlix.	2566	<i>Oleææ.</i>	cli.	2578
<i>Philadelphææ.</i>	cxlix.	2567	<i>Ligustrum</i>	cli.	2578
<i>Philadelphus</i>	cxlix.	2567	+ <i>Notelæ'a</i>	cli.	2579
<i>Deutzia</i>	cxlix.	2567	<i>Jasminææ.</i>	cli.	2581
<i>Myrtææ.</i>	cl.	2567	<i>Apocynææ.</i>	cli.	2581
<i>Eucalyptus</i>	cl.	2567	<i>Pinca</i>	cli.	2581
<i>Lepidospermum</i>	cl.	2568	<i>Asclepiadææ.</i>	cli.	2581
<i>Crassulææ.</i>	cl.	2568	<i>Physiánthus</i>	cli.	2581
<i>Reaumuriææ.</i>	cl.	2569	<i>Bignoniææ.</i>	cli.	2581
<i>Reaumûria</i>	cl.	2569	<i>Solanææ.</i>	cli.	2581
<i>Cactææ.</i>	cl.	2569	<i>Solanum</i>	cli.	2581
<i>Grossulææ.</i>	cl.	2569	<i>Scrophulariææ.</i>	cli.	2581
<i>Escalloniææ.</i>	cl.	2570	<i>Pentstemon</i>	cli.	2582
<i>Escallonia</i>	cl.	2570	<i>Labiææ.</i>	cli.	2582
<i>Saxifragææ.</i>	cl.	2570	<i>Verbenææ.</i>	cli.	2583
<i>Umbellææ.</i>	cl.	2570	<i>Plumbaginææ.</i>	cli.	2583
<i>Hederææ.</i>	cl.	2570	<i>Chenopodiææ.</i>	cli.	2583
<i>Hamamelidææ.</i>	cl.	2570	<i>Polygonææ.</i>	cli.	2583
<i>Cornææ.</i>	cl.	2571	<i>Laurææ.</i>	cli.	2583
<i>Loranthææ.</i>	cl.	2571	<i>Proteææ.</i>	cli.	2584
<i>Caprifoliææ.</i>	cl.	2572	<i>Thymelææ.</i>	cli.	2584
<i>Viburnum</i>	cl.	2572	<i>Eleagnææ.</i>	cli.	2584
<i>Lonicera</i>	cl.	2572	<i>Aristolochiææ.</i>	cli.	2584
<i>Rubiææ.</i>	cl.	2573	<i>Euphorbiææ.</i>	cli.	2585
+ <i>Lonicèa</i> <i>Sw.</i>	cl.	2573	+ <i>Crôton L.</i>	cli.	2585
<i>Compôsitiæ.</i>	cli.	2573	+ <i>Adèlia L.</i>	cli.	2585
<i>Antennaria</i>	cl.	2573	<i>Urticææ.</i>	cli.	2586
<i>Epacridææ.</i>	cl.	2573	<i>Ulmææ.</i>	cli.	2586
<i>Ericææ.</i>	cl.	2574			
<i>Erica</i>	cl.	2574			
<i>Arbutus</i>	cli.	2575			

<i>Juglandàceæ.</i>	-	i.	iv.	<i>Balsamàceæ.</i>	-	i.	iv.
		clii.	2587			cliii.	2597
<i>Salicàceæ.</i>	-	clii.	2587	<i>Myricàceæ.</i>	-	cliii.	2597
<i>Salix</i>	-	clii.	2588	<i>Gnetàceæ.</i>	-	cliii.	2597
<i>Betulàceæ.</i>	-	clii.	2589	<i>Taxàceæ.</i>	-	cliii.	2597
<i>A'lnus</i>	-	clii.	2589	<i>ABIE'TINÆ.</i>	-	cliii.	2597
<i>Corylàceæ.</i>	-	clii.	2590	<i>CUPRESSINÆ.</i>	-	cliii.	2605
<i>Quércus</i>	-	clii.	2591	<i>Juniperus</i>	-	cliii.	2605
<i>Platanàceæ.</i>	-	clii.	2597				

APPENDIXES.

APP. I. Form of Return Paper	-	-	-	-	-	2609
APP. II. List of Trees and Shrubs growing in Italy, with their systematic and popular Italian Names	-	-	-	-	-	2610
APP. III. Priced Catalogues of Trees and Shrubs, contributed by British and Continental Nurserymen	-	-	-	-	-	2617
I. Catalogue of American and other Tree and Shrub Seeds, imported for Sale by George Charlwood	-	-	-	-	-	2618
II. Catalogue of Forest and Ornamental Trees, American Plants, and Flowering Shrubs, sold by Richard Forrest	-	-	-	-	-	2620
III. A List of Trees, Plants, &c. sold by Peter Lawson and Son, Edinburgh	-	-	-	-	-	2626
IV. Catalogue of Hardy Trees and Shrubs cultivated for Sale in the Nursery of the Brothers Baumann, at Bollwyller	-	-	-	-	-	2635
V. List of Trees and Shrubs taken from the Retail Catalogue of James Booth and Sons, Hamburg	-	-	-	-	-	2646

INDEXES.

Index to Genera, including the English Names and scientific Synonymes	-	2655
Index to Miscellaneous Subjects	-	2667
Index to Persons and Places	-	2672

ALPHABETICAL INDEX TO VOL. IV.

	I.	IV.	IV.		I.	IV.	IV.
<i>Abies D. Don</i>	- cxxxvii.	2293	2599	<i>Garryaceæ</i>	- cxxxii.	2031	
<i>Abietinae</i>	- cxxxiii.	2106	2599	<i>Ginkgo</i>	- cxxxiii.	2094	
Adam's Needle	- cxl.	2521		Gnetaceæ	- cxxxiii.	2062	2597
Agave L.	- cxl.	2529		Horse Tail	- cxxxiii.	2062	2597
Amboyne Pine	- cxl.	2447	2603	Juniper	- cxlii.	2487	2605
American Aloe	- cxlii.	2529		Juniperus L.	- cxlii.	2487	2605
<i>Araucaria R. et P.</i>	- cxl.	2432	2603	Larch	- cxxxix.	2350	2602
Arbor Vitæ	- cxl.	2454		<i>Làrix Tourne.</i>	- cxxxix.	2350	2602
Arundo	- cxl.	2592		<i>Liliaceæ</i>	- cxliv.	2515	
<i>Asparagus L.</i>	- cxlii.	2516		Liquidambar	- cxxxii.	2049	2597
<i>Balanoidææ</i>	- cxxxii.	2048	2597	Luz's Brig.	- cxlii.	2528	
Bambus	- cxli.	2532		<i>Monocotyledoneæ</i>	- cxl.	2527	
Bambos	- cxlii.	2532		<i>Myrica L.</i>	- cxxxii.	2055	2597
Becher's Broom	- cxlii.	2517		<i>Myricaceæ</i>	- cxxxii.	2055	2597
<i>Callitris Vent.</i>	- cxlii.	2462		New Zealand Flax	- cxlii.	2399	
Candleberry Myrtle	- cxxxii.	2055	2597	Phoradendron	- cxlii.	2399	
Canavalia	- cxxxii.	2060		Phyllocladia	- cxxxii.	2100	2597
Casuarina	- cxl.	2402	2603	<i>Picea D. Don</i>	- cxxxviii.	2329	2601
Cedar	- cxl.	2402	2603	Pine	- cxxxviii.	2152	2597
<i>Cedrus Barrel.</i>	- cxl.	2402	2603	<i>Pinaceæ</i>	- cxxxviii.	2103	2597
<i>Caradonia W.</i>	- cxlii.	2506		<i>Pinus L.</i>	- cxxxviii.	2152	2597
Chamaecyparis	- cxlii.	2530		<i>Platanus L.</i>	- cxxxi.	2033	2596
Chili Pine	- cxl.	2432	2603	Plane Tree	- cxxxi.	2033	2596
Chinese Fir	- cxl.	2445		<i>Platanaceæ</i>	- cxxxi.	2032	2596
Crowberry	- cxlii.	2506		<i>Podocarpus L.</i>	- cxxxii.	2100	
<i>Comptonia Banks</i>	- cxxxii.	2059		<i>Ruscus L.</i>	- cxliv.	2517	
<i>Conifere</i>	- cxxxiii.	2103	2597	Salisbury Sm.	- cxxxiii.	2094	
<i>Conium D. Don</i>	- cxlii.	2506		Silver Fir	- cxxxviii.	2329	2601
Cunninghãmia R. Br.	- cxl.	2445		<i>Smilacææ</i>	- cxliii.	2509	
<i>Cupressinae</i>	- cxl.	2453	2605	<i>Smilax L.</i>	- cxliii.	2510	
<i>Cupressus L.</i>	- cxli.	2464	2605	Spruce Fir	- cxxxvii.	2293	2599
Cypress	- cxli.	2464	2605	<i>Tardææ</i>	- cxxxiii.	2065	2597
<i>Dacrydium Sal.</i>	- cxxxiii.	2100		Taxodium	- cxlii.	2480	
Dammara	- cxl.	2447	2603	<i>Taxus L.</i>	- cxxxiii.	2066	2597
<i>Dammara Rumph.</i>	- cxl.	2447	2603	<i>Thuja L.</i>	- cxl.	2454	
Deciduous Cypress	- cxlii.	2480		Yew Tree	- cxxxiii.	2066	2597
Dwarf Fan Palm	- cxlii.	2530		<i>Yucca L.</i>	- cxl.	2521	
<i>Euphorbia</i>	- cxlii.	2506					
<i>Euphorbia L.</i>	- cxlii.	2506					
<i>Ephedra L.</i>	- cxxxiii.	2062	2597				
<i>Fouquieria K. et Z.</i>	- cxlii.	2527					
Garrya	- cxxxii.	2031					

ALPHABETICAL INDEX TO THE SUPPLEMENT.

Only the names of those genera are given under which a new species or variety is introduced. New genera are distinguished by the sign of addition, thus, +; and generic names which have been altered, by parallel lines, thus, ||.

	I.	IV.		I.	IV.
<i>A'cer</i>	- cxlvii.	2542	<i>Anacardiaceæ</i>	- cxlvii.	2548
<i>Acerdæææ</i>	- cxlvii.	2541	+ <i>Anagris</i>	- cxlviii.	2549
+ <i>Adonia L.</i>	- cxlii.	2585	<i>Anonaceæ</i>	- cxlvi.	2536
<i>Esculâcææ</i>	- cxlvii.	2543	<i>Anthemia</i>	- cl.	2573
<i>Alnus</i>	- cxlii.	2589	<i>Apocynaceæ</i>	- cl.	2581
<i>Amgydâlææ</i>	- cxlviii.	2554	<i>Aguifoliâcææ</i>	- cxlvii.	2545
			<i>Arbutus</i>	- cli.	2575

	I.	IV.		I.	IV.
<i>Aristolochiacea</i>	clii.	2585	<i>Leptopérnum</i>	cl.	2568
<i>Aurantacea</i>	cxlvii.	2540	<i>Ligustrum</i>	clii.	2578
<i>Armeniaca</i>	cxlviii.	2554	<i>Loranthacea</i>	clii.	2571
<i>Asclepiadacea</i>	clii.	2581	<i>Lôteca</i>	cxlvii.	2547
<i>Balsamacea</i>	cliii.	2597	<i>Lonicera</i>	cl.	2572
+ <i>Baptisia</i>	cxlviii.	2549	+ <i>Lonicite Swt.</i>	cl.	2573
<i>Berberacea</i>	cxlvi.	2536	<i>Magnoliacea</i>	cxlvi.	2536
<i>Berberis</i>	cxlvi.	2537	<i>Málva</i>	cxlvi.	2538
<i>Betulacea</i>	clii.	2589	<i>Malvacea</i>	cxlvi.	2538
<i>Bignoniacea</i>	clii.	2581	<i>Myricacea</i>	cliii.	2597
+ <i>Boronia Sm.</i>	cxlv.	2544	<i>Myrtina</i>	clii.	2578
<i>Cactacea</i>	cl.	2569	<i>Myrsinacea</i>	clii.	2578
<i>Caprifoliacea</i>	cl.	2572	<i>Myrtacea</i>	cl.	2567
<i>Casinea</i>	cxlviii.	2554	+ <i>Neandria</i>	cxlvi.	2537
<i>Ceanothus</i>	cxlvii.	2547	<i>Oleacea</i>	clii.	2578
<i>Celastracea</i>	cxlvii.	2545	<i>Onagracea</i>	cxlix.	2566
<i>Cistacea</i>	cxlvi.	2538	<i>Paliurus</i>	cxlvii.	2547
<i>Chenopodiacea</i>	clii.	2583	<i>Paoniacea</i>	cxlvi.	2535
<i>Chimonanthus</i>	cxlix.	2566	<i>Pentstemon</i>	clii.	2582
<i>Clematidea</i>	cxlvi.	2534	<i>Phaseolca</i>	cxlviii.	2553
<i>Clématis</i>	cxlvi.	2535	<i>Philadelphacea</i>	cxlix.	2567
<i>Composita</i>	cl.	2573	<i>Philadelphus</i>	cxlix.	2567
<i>Conifera & Cupressina</i>	cliii.	2605	<i>Physiánthus</i>	clii.	2581
<i>Coriacea</i>	cxlvii.	2545	<i>Platanacea</i>	clii.	2597
<i>Cornacea</i>	cl.	2571	<i>Plumbaginacea</i>	clii.	2585
<i>Conifera & Abietina</i>	cliii.	2597	+ <i>Poinciana Dec.</i>	cxlviii.	2534
+ <i>Cornus Sm.</i>	cxlvi.	2544	<i>Polygalacea</i>	cxlvi.	2538
<i>Corylacea</i>	clii.	2590	<i>Polygonacea</i>	clii.	2583
<i>Cotoneaster</i>	cxlix.	2563	<i>Potentilla</i>	cxlviii.	2557
+ <i>Cowania D. Don</i>	cxlix.	2557	<i>Proteacea</i>	clii.	2584
<i>Crossidacea</i>	cl.	2568	<i>Pyrus</i>	cxlix.	2565
<i>Crataegus</i>	cxlix.	2563	<i>Quercus</i>	clii.	2591
+ <i>Crataegus Sm.</i>	cxlvii.	2544	+ <i>Reaumuriacea</i>	cl.	2569
+ <i>Croton L.</i>	clii.	2585	+ <i>Reaumuria</i>	cl.	2569
<i>Crucifera</i>	cxlvi.	2538	<i>Rhamnacea</i>	cxlvii.	2546
+ <i>Cyrtilla</i>	cl.	2577	<i>Rhamnus</i>	cxlvii.	2547
<i>Cytisus</i>	cxlviii.	2551	<i>Rhus</i>	cxlvii.	2548
<i>Dasmárium</i>	cxlviii.	2552	<i>Rosa</i>	cxlix.	2559
<i>Deutzia</i>	cxlix.	2567	<i>Rosacea</i>	cxlix.	2554
<i>Diospyros</i>	clii.	2578	<i>Rosea</i>	cxlix.	2558
<i>Ebenacea</i>	clii.	2578	<i>Rubiacea</i>	cl.	2575
<i>Elaeagnacea</i>	clii.	2584	<i>Rosa</i>	cxlvii.	2544
<i>Erica</i>	cl.	2574	<i>Rutacea</i>	clii.	2587
<i>Ericacea</i>	cl.	2574	<i>Salicacea</i>	clii.	2588
<i>Epacridacea</i>	cl.	2573	<i>Salix</i>	clii.	2578
<i>Epigaea</i>	clii.	2575	<i>Sapotacea</i>	cl.	2570
<i>Escallonia</i>	clii.	2570	<i>Saxifragacea</i>	cl.	2582
<i>Escalloniacea</i>	cl.	2570	<i>Scrophulariacea</i>	clii.	2581
<i>Eucalyptus</i>	cl.	2568	<i>Solanacea</i>	clii.	2582
<i>Euonymus</i>	cxlvii.	2545	<i>Solanum</i>	clii.	2559
<i>Euphorbiacea</i>	clii.	2585	<i>Spártium</i>	cxlviii.	2549
<i>Genista</i>	cxlviii.	2551	<i>Sophoreæ</i>	cxlviii.	2556
<i>Gnetacea</i>	cliii.	2597	<i>Spiraea</i>	cxlviii.	2555
<i>Grenatacea</i>	cxlix.	2566	<i>Spiraea</i>	cxlix.	2563
<i>Grossulacea</i>	cl.	2570	<i>Stranvæ'sia</i>	cliii.	2595
<i>Hamamelidacea</i>	cl.	2570	<i>Taxacea</i>	cxlvi.	2538
<i>Hederacea</i>	cl.	2562	<i>Tiliacea</i>	cxlvi.	2540
<i>Halystris</i>	cxlvii.	2541	<i>Turnströmiacea</i>	clii.	2584
<i>Hypericacea</i>	cxlvi.	2541	<i>Thymelacea</i>	clii.	2586
<i>Hypéricum</i>	cxlvii.	2545	<i>Umbacea</i>	clii.	2570
<i>Ilex L.</i>	clii.	2581	<i>Umbellacea</i>	clii.	2586
<i>Jasminacea</i>	clii.	2587	<i>Urticacea</i>	clii.	2583
<i>Juglandacea</i>	cliii.	2605	<i>Verbenacea</i>	cl.	2572
<i>Juniperus</i>	cliii.	2583	<i>Viburnum</i>	cl.	2581
<i>Komodia</i>	cxlviii.	2582	<i>Vinca</i>	clii.	2541
<i>Labiacea</i>	clii.	2583	<i>Vitacea</i>	cxlvii.	2545
<i>Lauracea</i>	clii.	2583	<i>Xanthoxylacea</i>	cxlvii.	2545
<i>Leguminosa</i>	cxlviii.	2549			

ARBORETUM ET FRUTICETUM BRITANNICUM.

CHAP. CVI.

OF THE HARDY LIGNEOUS PLANTS OF THE ORDER GARRYACEÆ.

GARRYA Douglas. Flowers unisexual; those of the two sexes upon distinct plants. — Male. Flowers in pendulous catkin-like racemes within connate bracteas. Calyx 4-leaved. Stamens 4. — Female? Flowers in pendulous catkin-like racemes, within connate bracteas. Calyx connate with the ovary, 2-toothed. Ovary 1-celled. Styles 2, setaceous. Ovules 2, pendulous, with funiculi as long as themselves. Fruit a berried pericarp, not opening, containing 2 seeds. Embryo very minute, in the base of a great mass of fleshy albumen. — Species, 1. A native of the west side of the dividing mountain range of North America, in temperate latitudes. A shrub. Leaves opposite, without stipules, persistent. Wood without distinct concentric zones, or vasiform tissue (dotted ducts). (*Lindley's Nat. Syst. of Botany*, p. 173.)

GENUS I.



GARRYA Doug. THE GARRYA. *Lin. Syst. Dicæcia* Tetrándria.

Identification. Lindl. in Bot. Reg., t. 1686.

Description. Named by Mr. Douglas in compliment to *Nicholas Garry, Esq.*, Secretary to the Hudson's Bay Company, to whose kindness and assistance he was much indebted during his travels in North-west America.

Description, &c. An evergreen shrub, with thick coriaceous leaves, like some species of evergreen viburnum.

■ 1. **G. ELLIPTICA** Doug. The elliptic-leaved Garrya.

Identification. Doug. MS.; Lindl. Bot. Reg., t. 1686.

Engravings. Bot. Reg., t. 1686; and our fig. 1951.

Description, &c. A shrub, hitherto seen only from 3 ft. to 4 ft. high, but which will probably grow much higher. Branches, when young, pubescent and purplish; when older, smooth and greyish. Leaves opposite, exstipulate, wavy, on short footstalks, oblong-acute, leathery, evergreen; dark green and shining above; hoary beneath, with simple, twisted, interwoven hairs. (*Lindl.*) This very handsome true evergreen is a native of North Carolina, where it was discovered by Douglas. It was introduced in 1828, and flowered for the first time, in the Chiswick Garden, in October, 1834. The following observations, abridged from the *Botanical Register*, are by Dr. Lindley: — This plant is probably the greatest botanical curiosity sent home by Douglas; for it appears to represent a natural order altogether distinct from any previously known, and connecting certain well-known natural orders

in an unexpected and satisfactory manner. In its amenable inflorescence, imperfect calyx, superior calyx, and mode of germination, *Gárrya* is very similar to *Cupulíferæ*, from which it differs most essentially in its wood without concentric circles or dotted vessels, its opposite exstipulate leaves, simple fruit, and minute embryo lying in a great mass of albumen. The latter characters bring it near *Piperæcæ* and their allies, especially *Chloránthæ*, with which its zoneless wood (for *Chloránthus* has no annual zones), simple fruit, and opposite leaves, also agree; but the stipules of *Chloránthæ*, together with its achlamydeous bisexual flowers, and articulated stems, distinctly separate that order." (*Bot. Reg.*, t. 1686.) Only the male plant of *Gárrya elliptica* is in the country. When in flower (which it is from December till April), the plant has a most striking and graceful appearance, from its slender pendulous catkins, many of which are 8 in. to 1 ft. in length. It was at first grown in peat, but appears to prefer a loamy soil. It is readily increased by layers; and by cuttings in sand under a hand-glass. Plants, in the Fulham Nursery, in 1837, were 21s. each.



CHAP. CVII.

OF THE HARDY LIGNEOUS PLANTS OF THE ORDER PLATANACEÆ.

PLATANUS *Tourn.* Flowers unisexual; those of the two sexes upon one plant, and those of each sex disposed many together, and densely, in globular catkins, that are sessile upon pendulous rachises, 2 generally upon a rachis; the flowers of each sex upon a separate rachis, produced from a separate bud.—Catkin of male flowers constituted of minute, rather fleshy, persistent bracteas, and of deciduous stamens. Filaments very short, situated between the bracteas, and of about their length. Anthers of 2 cells, longer than the filament; attached longitudinally to a connectivum, which is broader than the filament, and has a peltate tip.—Catkin of female flowers constituted of bracteas and pistils. Pistils numerous, approximately pairs. Ovary of 1 cell, including 1—2 pendulous ovules. Stigmas 2, long, thread-shaped, glanded in the upper part. Fruit a utricle, densely covered with articulated hairs, including 1 pendulous, oblong, exalbuminous seed.—Species, about 4. Natives of the temperate zones of the eastern and western hemispheres. Tall trees. Leaves alternate, palmate, annual; their margins revolute in the bud. Leaf-bud covered with a conical envelope; and immersed, in the preceding year, in the base of the petiole. (*T. Nees ab Esenb. Gen. Pl. Fl. Germ.*, and observation.) The young shoots, leaves, and stipules are thickly covered with down, which as soon as they become fully expanded is cast off, and, floating in the atmosphere, is inhaled by gardeners and others who have occasion to be much among the trees, and produces a cough which is extremely disagreeable, and is not got rid of for several weeks. The inconvenience arising from this down, Michaux informs us, is well known in America, and it has been long familiar to French nurserymen. M. Ch. Morren, Professor of Botany at the University of Liege, gives an account of it in the *Transactions of the Royal Academy of Brussels*, under the title of "Note sur l'Effet pernicieux du Duvet du Platane;" the only preventive which he mentions is the obvious one adopted by M. Henrard, nurseryman at Liege, viz., that of covering the nose and the mouth with a handkerchief of fine gauze. (See p. 2045., and *L'Echo du Monde Savant*, Jan. 6. 1838.)

GENUS I.



PLATANUS L. THE PLANE TREE. *Lin. Syst. Monœ'cia Polyândria.*

Identification. Lin. Gen., 1075; Reich., 1173.; Schreb., 1451.; Gærtn., t. 90.; Tourne., t. 363.; Juss., 410.; N. Du Ham., 2 p. 5.; Willd. Sp. Pl., 4. p. 473.

Synonymæ. Platanus, Fr.; Platanus, Ger.

Derivation. From *platys*, ample; in allusion to its spreading branches and shady foliage. The name of plane tree is applied, in Scotland, to the *Acer Pseudo-Platanus* (see p. 414.); probably because the French, according to Parkinson, first called that the plane tree, from the mistake of Tragus, who fancied, from the broadness of its leaves, that it was the plane tree of the ancients.

Description, &c. Lofty deciduous trees, with widely spreading branches, dense foliage, and bark scaling off in hard irregular patches. Natives of the east of Europe, west of Asia, and north of Africa, and of North America. In Britain, they are chiefly planted for ornament, and they succeed in any free moist soil, in a sheltered situation. They are readily propagated by layers, or even by cuttings, and sometimes by seeds. The cause of the falling off of the bark, Dr. Lindley states to be the rigidity of its tissue; on account of which it is incapable of stretching as the wood beneath it increases in diameter. (*Nat. Syst.*, ed. 2., p. 187.) There are only two species introduced into Europe; one of which, *P. orientalis*, is found to be hardier than *P. occidentalis*, though the latter grows more rapidly, attains a larger size, and may be propagated much more readily by cuttings. Both species ripen seeds in

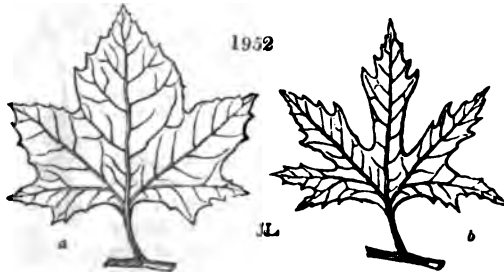

Britain, in fine seasons. *P. occidentalis* is readily known from *P. orientalis*, in the winter season, by its bark scaling off much less freely, or, in young or middle-sized trees, scarcely at all; and, in the summer season, by its leaves being but slightly lobed (see fig. 1952. a), instead of being palmate like those of *P. occidentalis*, as shown in fig. 1952. b; and by its globular catkins, or balls, as they are commonly called, being nearly smooth, while those of *P. orientalis* are rough. The appearance of these catkins, or balls, hanging from the tree by long threads, in winter, when it is without leaves, is peculiarly graceful; whether they hang from the perpendicular or from the horizontal branches (see figs. 1953. and 1954.); reminding us of the divi ladner of Ceylon, the *Tabernæmontana alternifolia* of botanists (fig. 1954.); which, it is fabled, was the forbidden fruit of Paradise. (See *Mag. Nat. Hist.*, vol. v. p. 449.) It is a singular fact, that many of the large trees of *P. occidentalis* in Britain, more especially in England, were so far injured by a frost in May, 1809, that they have since died.

‡ 1. *P. ORIENTALIS* L. The Oriental Plane.

Identification. Willd. Sp. Pl., 4. p. 473.; Hort. Cliff., 447.; Roy Lugdb., 78.; Hasselq. It., 487.; Gron. Orient., 293.; Mill. Dict., No. 1.; Hort. Kew., 3. p. 364.; N. Du Ham., 2 p. 1.

Synonymæ. *Platanus orientalis* vèrus *Park. Theatr.*, 1427., *Du Ham. Arb.*, 2. t. 33.; *Platanus de l'Orient*, Fr.; *Morgenlandscher Platanus*, Ger.; *Doolb*, Arabic; *Chinar*, Persian.

Engravings. Du Ham. Arb., t. 33.; N. Du Ham., 2 t. 1.; Dend. Brit., t. 101.; our fig. 1954.; and the plates of this species in our last Volume. In fig. 1955. a shows the female catkins transversely cut, so as to show the position of the orbicular receptacle; b shows a section of the female catkin in seed; c, a scale and pistil; d, stamen and scale; e, the longitudinal section of a seed; and f, an entire seed.

Spec. Char., &c. Leaves 5-lobed, palmate, wedge-shaped at the base; the divisions lanceolate, sinuated. Stipules nearly entire. (*Willd.*) A tree, growing to the height of from 60 ft. to 80 ft.; a native of the Levant;

flowering in April and May, and, in some seasons, in England, ripening its seeds in October. Cultivated in British gardens before 1548.

Varieties.

† *P. o. 2 acerifolia* Ait. Hort. Kew., iii. p. 364.; *P. o. A'ceris folio* Tourn. Cor., 41., Arb., 2.; *P. acerifolia* Willd. Sp. Pl., iv. p. 474.; *P. intermedia* Hort.; the *Maple-leaved Plane Tree* (see the plate of this tree in our last Volume); has the leaves cordate, 5-lobed, remotely dentate, truncate at the base.

(Willd.) In general appearance, habit of growth, and every other particular, it closely resembles the species. The leaves on the trees in the Horticultural Society's Garden, and at Messrs. Loddiges's, are, perhaps, not quite so large; and they are somewhat like those of the sugar maple. There are vigorous young trees in the Horticultural Society's Garden; and a fine specimen in the grounds of A. Salvin, Esq., at Finchley, of which a portrait is given in our last Volume.

† *P. o. 3 hispánica*; *P. hispánica* Lodd. Cat., ed. 1836; *P. macrophylla* Cree in Don Cat.; the *Spanish Maple*; has the leaves rather longer than those of the species, but is in other respects the same.

† *P. o. 4 cuneata*; *P. o. undulata* Ait. Hort. Kew., iii. p. 364.; *P. cuneata* Willd. Sp. Pl., iv. p. 473., *Baumzucht*, p. 283.; and the plate of this tree in our last Volume; has the leaves 3—5-lobed, dentate, and wedge-shaped at the base; somewhat glabrous. (Willd.)

This is a stunted-looking low tree, or bush, seldom seen above 20 ft. in height, with small deeply cut leaves. It may be useful in small gardens, or miniature arboretums, as affording a specimen of the genus. There is a young tree of this kind in the Horticultural Society's Garden, of which the plate in our last Volume is a portrait.

Other Varieties might be selected from beds of seedlings, if it were thought worth while to keep them distinct; and, if a pendulous-branched or fastigate plane could be procured, or one subevergreen, in point of variety they would be acquisitions.

Description, &c. The Oriental plane is one of the noblest trees of the East, where it grows to the height of 70 ft. and upwards, with widely spreading branches and a massive trunk; forming altogether a majestic tree. The bark of the trunk is smooth, and of a whitish grey; scaling off every year in large irregular patches. The branches are numerous, round, and generally a little crooked, or zigzag, at the joints; the bark of the young shoots is brown, inclining to purple. The leaves are large, alternate, and on long petioles, which are swelled at the base, and cover the buds: they are cut into five deep

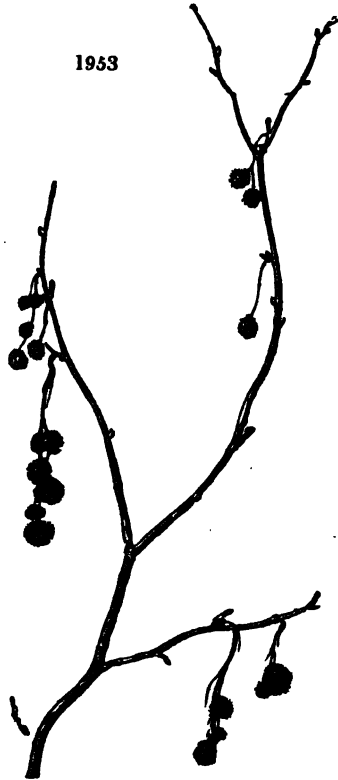

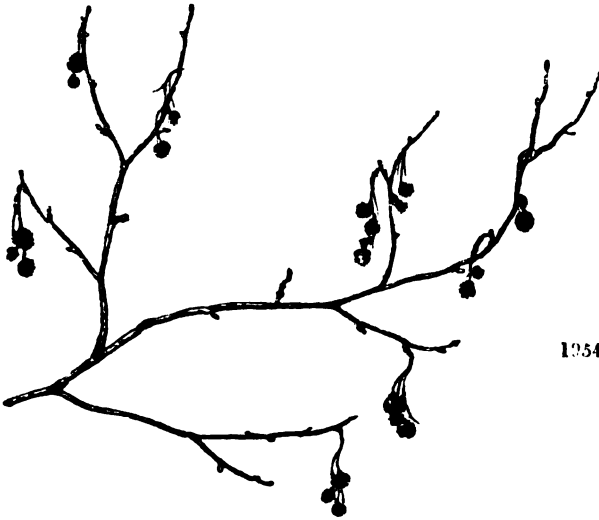

1954

pointed lobes, or segments, the two outer of which are again slightly lobed; the five large lobes have numerous acute indentations on their margins, and have each a strong midrib, with many lateral veins spreading from it; the upper surface is glabrous, and of a shining green; and the under surface paler, and slightly tomentose at the angles of the veins.

The flowers are produced in globular catkins, from two to five on an axillary peduncle, which is sometimes 6 in. long; the sexes being in distinct catkins. These catkins, or balls, vary very much in size, being sometimes 4 in. in circumference, and sometimes not quite 1 in. The flowers are so small as to require a glass to distinguish them. The balls appear before the leaves, in spring; and the seeds, in fine

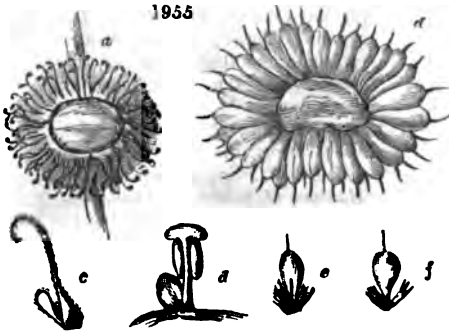

seasons, ripen late in autumn; the balls remaining on the tree till the following spring; and, when they open, the bristly down which surrounds the seeds, helps to convey them to a distance. The seeds, when deprived of their down, are brown, linear, smaller than those of the lettuce, and quite as light; Cobbett describes the seed of the plane tree as "a little brown thing, in the shape of a round nail without a head." The growth of the plane is very rapid; young trees, in the climate of London, under favourable circumstances, attaining the height of 30 ft. in ten years, and arriving at the height of 60 ft. or 70 ft. in 30 years. The longevity of the tree was supposed, by the ancients, to be considerable; but there are very few old trees in Britain. One of the oldest is that still existing at Lee Court, in Kent, which was mentioned by Evelyn, in 1683, as one of the oldest introduced into this country, and as being celebrated both for its age and its magnitude. (See *Recorded Trees*.) Some of the largest trees in the neighbourhood of London are at Mount Grove, Hampstead, where they are between 70 ft. and 80 ft. in height. The



largest we know of, however, (of which *fig.* 1957. is a portrait, taken in May, 1837,) stands in the grounds of Lambeth Palace, adjoining a magnificent specimen of *P. occidentalis*; it is 90 ft. high, with a trunk 4 ft. 6 in. in diameter. The platanus, when of not more than 50 or 60 years' growth, stoles readily when cut down to the ground, and, when so treated, will make shoots in one season of 6 ft. or 8 ft., or even more, in length.

Geography. The Oriental plane is a native of Greece, and of other parts of the Levant: it is found in Asia Minor, and Persia, where, according to Royle, it extends as far south as Cashmere. (*Illust.*) According to Pallas, it is doubtful whether it is indigenous to Georgia, though there are trees of it there, with trunks 12 ft. in circumference, and of a great height. On Mount Caucasus, it is not much higher than a shrub. It is found on the coast of Barbary, as it is in the south of Italy, and in Sicily; but is probably not indigenous to those countries. (See *History.*) On Mount Etna, it is found as high as 2000 ft. above the level of the sea. It is not a gregarious tree, seldom growing in extensive masses; and the individuals, when of large size, are always found on plains, and in a light deep soil, not far from water. Olivier tells us that it is common on the banks of the rivulets in Greece, in the islands of the Archipelago, and on the coast of Asia Minor; but he never found it of a large size, except in good soil near water.

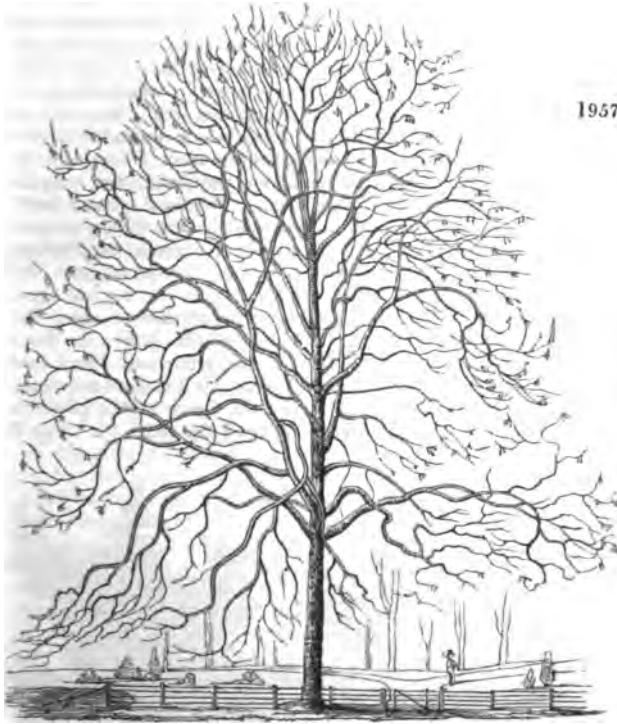

History. The platanus is celebrated in the earliest records that we have of Grecian history. Herodotus tells us that Xerxes, when he invaded Greece, was so enchanted with a beautiful plane tree that he found in Lycia, that he encircled it with a collar of gold, and confided the charge of it to one of the Ten Thousand. Ælian adds to this, that Xerxes passed an entire day under its shade, compelling his whole army to encamp in its neighbourhood; and that the delay this occasioned was one of the causes of his defeat. Evelyn adds, from the same author (viz. Ælian), that Xerxes became so fond of this tree, "that, spoiling both himself, his concubines, and great persons of all their jewels, he covered it with gold, gems, necklaces, scarfs, bracelets, and infinite riches. In sum, he was so enamoured of it, that, for some days, neither the consideration of his expedition, nor interest of honour, nor the necessary motion of his portentous army, could persuade him from it. He styled it his mistress, his minion, his goddess; and, when he was forced to part from it, he caused a figure of it to be stamped on a medal of gold, which he continually wore about him." (*Hunt. Evel.*, ii. p. 52.) Pausanias (A. D. 170) mentions a plane tree of extraordinary size and beauty in Arcadia, which was said to have been planted by Menelaus, the husband of Helen, and to have been, at the time Pausanias saw it, 1300 years old. According to the same author, the Lacedæmonians gave the name of Plataniste to an island in the Levant, connected by two bridges with the Morea, which was covered with plane trees, and where the young men used to perform their exercises. Some of these trees, it is said, still exist. It was in this island, according to Theocritus, that the flowers were gathered of which Helen's wedding garland was composed, on the day of her nuptials with Menelaus. We are also told that, in the time of Pliny, the peasants in Phrygia showed a plane tree, which they

affirmed was the tree against which Marsyas was hanged up when he was flayed by Apollo. Plane trees were planted near all the public schools in Athens. The groves of Epicurus, in which Aristotle taught his peripatetic disciples; the shady walks planted near the Gymnasia, and other public buildings of Athens; and the groves of Academus, in which Plato delivered his celebrated discourses; were all formed of this tree. Socrates swore by the plane tree; and this was one of the things which offended Melitus, who thought it a great crime to swear by so beautiful a tree. Pliny informs us that the plane was first brought from the East, over the Ionian Sea, into the Island of Diomedes, for a monument to that hero. Thence it passed into Sicily, where Dionysius the elder planted it in his garden at Syracuse, about 400 B. C.; and this garden, in after times, became a place of exercise for youths. Soon after the plane tree was planted in Sicily, it was introduced into Italy, and thence, Pliny adds, into the country of the Morini, a maritime people of Gaul, who paid a tribute to the Romans for permission to enjoy its shade. Dionysius the geographer compares the form of the Morea in the Levant, the ancient Peloponnesus, to the leaf of this tree; and Pliny makes the same remark in allusion to its numerous bays. To illustrate this comparison, Martyn, in his *Virgil* (vol. ii. p. 149.), gives a figure of the plane tree leaf (see *fig. 1958. a*), and a map of the Morea (*fig. 1598. b*). The Romans



set a high value on the plane, and planted their public and academic walks with it. Vitruvius says that they planted plane trees to shade and refresh the palaestras (lib. v. c. 11.); and "Claudius Perrault has assisted the text with a figure, or ichnographical plot. These trees the Romans," continues Evelyn, "first brought out of the Levant, and cultivated with so much industry and cost, for their stately and proud heads only, that the great orators and statesmen, Cicero and Hortensius, would exchange now and then a turn at the bar, that they might have the pleasure to step to their villas, and refresh their platans, which they would often irrigate with wine instead of water: *Crevit et affuso latior umbra mero.*" (*Hunt. Evel.*, ii. p. 55.) "Much has been said," observes Pliny, "of the plane trees in the Lyceum at Athens, of which the roots extended even farther than the branches. There is now in Lycia a famous plane tree, on the public road, near a very cold fountain. This tree is in itself a forest: its branches are as large and thick as trees, and they cover an immense extent of ground with their shade. The trunk of this tree, which is 81 ft. in circumference, is hollow, and has inside numerous stones covered with moss. This tree was such a favourite with Licinius Mucianus, three times governor of the province of Lycia, that he thought it worth while to hand down to posterity, that he had eaten in this hollow tree, or grotto, with eighteen persons, who had, for couches or cushions to recline on, only the leaves of the tree (*large ipsa toros praebente fronde*); that the thickness of the foliage sheltered them from a heavy shower of rain; and that he (the governor) enjoyed more pleasure during his repast in this tree, than

he had ever done in his most magnificent marble saloon." (*Plin.*, lib. xii. c. 1.) "The emperor Caligula found, near Velitræ, an extraordinary plane tree. It had some of its branches formed like a roof, and others as seats. In this saloon the emperor gave a supper to fifteen persons, which he called the Feast of the Nest, because it had been given in a tree (*Quam canam appellavit ille nidum*)." (*Id.*) Pliny also speaks of a tree in Arcadia, which, he says, was planted by Agamemnon; and he states that canoes, and other vessels for the sea, were formed of the excavated trunks of the plane tree. Cicero mentions the plane tree as well calculated to afford a thick shade, by the extent of its branches, and the thickness of its foliage.

The chinar, or Oriental plane tree, has been cultivated in Persia from the earliest period; and Evelyn states that "a worthy knight, who staid at Ispahan when that famous city was infected with a raging pestilence, told" him "that, since they have planted a greater number of these noble trees about it, the plague has not come nigh their dwellings." (*Hunt. Esol.*, ii. p. 56.) In the *Dictionnaire des Eaux et Forêts*, the same observation is attributed to the Chevalier Chardin, who was probably the "worthy knight" alluded to by Evelyn. This gentleman, who was also called Sir John Chardin, and who published a folio edition of his travels, written in French, in London, in 1686, observes of the gardens of the Persians, that they are generally divided in the middle by an avenue of chinar trees; and that, as the Persians do not use their gardens for walking in, but as a place for sitting in and breathing the fresh air, they generally seat themselves under these trees. Sir Robert Ker Porter found the Persian gardens intersected by avenues of plane trees in different directions; and Morier, Colonel Johnson, and Sir William Ousely, agree in attributing to them this characteristic, and in describing the Persians as preferring the chinar as a tree to worship under. Sir William Ousely mentions that on these trees the devotees sacrifice their old clothes by hanging them to the branches; and that the trunks of favourite chinar trees are commonly found studded with rusty nails and tatters; the clothes sacrificed being left nailed to the tree till they drop to pieces of themselves.

In Fraser's *Historical and Descriptive Account of Persia*, published in 1834, when speaking of the general effect of the scenery in Persia, the author says: "No trees gladden the landscape, except the tall poplar, or the stately chinar (*Platanus orientalis*), which rise above the hovels of the peasants; or the fruit trees of their orchards; or, perhaps, a few of other sorts which may have been planted on the margin of a watercourse, to supply the little timber required: and these, dotting the wide plain with their dark foliage, convey to the mind a melancholy, rather than cheering, impression." (p. 26.)

The Oriental plane tree appears to have been introduced into England about the middle of the sixteenth century; as Turner says, in his *Herball* (the first part of which was published under the title of the *Names of Herbes*, as early as 1544, though the entire work was not finished till 1568): "I have scene two very yong trees in England, which were called there Playn trees; whose leaves in all poyntes were lyke unto the leaves of the Italian Playn tre. And it is doubtles that these two trees were either brought out of Italy, or of som farr countre beyond Italy, wherunto the frieres, monks, and chanons went a pilgrimage." Gerard does not mention having seen the Oriental plane growing in England; but he tells us that his "servant, William Marshall, whom he sent into the Mediterranean Sea, as surgeon unto the Hercules of London, found divers trees hereof growing in Lepanto, hard by the sea side, at the entrance into the towne, a port of Morza, being part of Greece; and from thence brought one of these rough buttons, being the fruit thereof." (*Herball*, p. 1489.) Jonson, in his edition of Gerard, adds to this passage, that Mr. Tradescant had then (1633) trees of this plane growing in his garden; but, according to Martyn's *Miller*, this is evidently a mistake, the trees in Tradescant's garden being the Occidental plane, which was introduced by him about this period. In Parkinson's *Theatrum Botanicum*, published in 1640, both the Eastern and Western plane trees are figured; and the

latter is said to have been introduced by Tradescant. The introduction of the Eastern plane was, in Miller's time, generally attributed to Lord Bacon, who, however, was not born till 1561, about 20 years after the first mention of the tree by Turner. The origin of this supposition is probably the statement, by Evelyn, that Lord Bacon "planted a noble parcel of them at Verulam, which were very flourishing," and which, as Martyn remarks, might have been the first of any note planted in England. Evelyn says "that he owed a hopeful plant," then growing at his own villa, "to the late Sir George Crook of Oxfordshire;" and he speaks of the true, or Oriental, plane" as being more common in England, in his time, than the American plane; the reverse of which, it may be observed, is now the case; the Occidental plane being easily propagated by cuttings, and growing much more rapidly than the Oriental plane. In France, the Oriental plane was introduced from England, in the reign of Louis XV., about 1754; and it is valued there, as in England, only as an ornamental tree.

Poetical Allusions. Homer frequently mentions "the shady plane;" Theocritus tells us that the virgins of Sparta used to assemble round a plane tree, singing, "Reverence me, for I am the tree of Helen!" and Moschus says,—

"I love to sleep beneath a leafy plane."

Among the Latins, Virgil calls it the sterile, and the aerial plane, in allusion to its not bearing eatable fruit, and to its height; and Horace invites Hirpinus to drink Falernian wine under its shade. Ovid, also, calls it "the genial plane." Among the oldest English poets we find no allusion to this tree; but Browne mentions

"The heavy-headed plane tree, by whose shade
The grape grows thickest, men are fresher made."

Among the modern British poets, Southey says, —

"And broad-leaved plane trees in long colonnades
O'erarch'd delightful walks,
Where round their trunks the thousand-tendrill'd vine
Wound up, and hung the boughs with greener wreaths,
And clusters not their own."

Thalaba.

Moore, in the *Veiled Prophet of Khorassan*, calls it the chinarr tree:—

"While some, for war's more terrible attacks,
Wield the huge mace and ponderous battle-axe;
And, as they wave aloft in Morning's beam
The milk-white plumage of their helms, they seem
Like a chinarr tree grove when Winter throws
O'er all its tufted heads his feathering snows."

And again, in *Paradise and the Peri*:—

"Though sunny the lake of cool Cashmere,
With its plane tree isle reflected there."

Properties and Uses. The Oriental plane, in a wild state, as far as we know, supports few or no insects; and still fewer lichens or fungi live on its bark, because that is continually scaling off. Very little use is made of the wood in the west of Europe; but in the Levant, and in Asia, it is said to be used in carpentry, joinery, and cabinet-making; and, according to Riccioli, who wrote in 1651, it was then employed in ship-building by the Turks. It is said to make beautiful furniture, on account of the smoothness of its grain, and its susceptibility of taking a high polish. Olivier says that its wood is not inferior for cabinet-work to any wood of Europe; and that the Persians employ no other for their furniture, their doors, and their windows. (*Trav.*, i. p. 76.) The Greeks of Mount Athos, according to Belon, formed boats out of the trunks of large trees of this species, similar to those which are used in modern times on the Somme and on the Seine, in France. Sometimes, also, boats were made of two trunks hollowed out, and joined together so as to fit, and be water-tight. The wood of the Oriental plane, according to the experiments of M. Hassenfratz, weighs, when dry, 49 lb. 3 oz. per cubic foot: it is of a yellowish white till the tree attains considerable age; after which it becomes brown, mixed with jasper-like veins; and wood of this kind, being rubbed with

oil, and then highly polished, resembles the wood of the walnut. In Britain, as far as we know, the wood of the Oriental plane has scarcely been applied to any purpose either useful or ornamental; though for both it may be classed, as Marshall suggests, with that of the *Acer Pseudo-Platanus*; or, according to some French authors, with that of the beech or the hornbeam. By the Persians, and by the Greeks and Romans, as we have already seen, the tree, in a growing state, was greatly esteemed for its shade, and was planted near houses, in open groves, avenues, and rows, for that purpose. Pliny affirms that there is no tree whatsoever that defends us so well from the heat of the sun in summer, or that admits it more kindly in winter. Both properties result from the large size of its leaves: in summer, these present horizontal imbricated masses, which, while they are favourable to the passage of the breeze, yet exclude both the sun and the rain; while, as the distance at which the branches and twigs of trees are from one another, is always proportionate to the size of the leaves, hence the tree, in winter, is more than usually open to the sun's rays. As an ornamental tree, no one, which attains so large a size, has a finer appearance, standing singly, or in small groups, upon a lawn, where there is room to allow its lower branches, which stretch themselves horizontally to a considerable distance, gracefully to bend towards the ground, and turn up at their extremities. The peculiar characteristic of the tree, indeed, is the combination which it presents of majesty and gracefulness; an expression which is produced by the massive, and yet open and varied character of its head, the bending of its branches, and their feathering to the ground. In this respect, it is greatly superior to the lime tree, which comes nearest to it in the general character of the head; but which forms a much more compact and lumpish mass of foliage in summer, and, in winter, is so crowded with branches and spray, as to prevent, in a great measure, the sun from penetrating through them. The head of the plane tree, during sunshine, often abounds in what painters call flickering lights; the consequence of the branches of the head separating themselves into what may be called horizontal undulating strata, or, as it is called in artistical phraseology, tufting, easily put in motion by the wind, and through openings in which the rays of the sun penetrate, and strike on the foliage below. The tree is by no means so suitable for an extensive park, or for imitations of forest scenery, as most others; but, from its mild and gentle expression, its usefulness for shade in summer, and for admitting the sun in winter, it is peculiarly adapted for pleasure-grounds, and, where there is room, for planting near houses and buildings. For the latter purpose, it is particularly well adapted even in winter, from the colour of the bark of the trunk, which has a greyish white tint, not unlike the colour of some kinds of freestone. The colour of the foliage, in dry soil, is also of a dull greyish green; which, receiving the light in numerous horizontal tuftings, readily harmonises with the colour of stone walls. It appears, also, not to be much injured by smoke, since there are trees of it of considerable size in the very heart of London: one, for example, in Cheapside.

Soil, Situation, Propagation, &c. A light deep free soil, moist, but not wet at bottom, is that on which the Oriental plane tree thrives best; and the situation should be sheltered, but, at the same time, not shaded or crowded by other trees. It will scarcely grow in strong clays, and on elevated exposed places; nor will it thrive in places where the lime tree does not prosper. The plane tree may be propagated by seeds, layers, or cuttings. The seeds should be gathered in October or November; and, the balls being broken by the hand, or by threshing with a flail, the seeds may be separated from their husks, and cleaned by the usual processes, and either sown immediately, or mixed with sand, or fine sandy soil, and preserved in a place secure from frost till February or March. The seeds may also be kept in the balls, or catkins, till spring; either by allowing them to hang on the tree, or by gathering them in autumn, and spreading them out in a dry loft. The general practice is to sow the seeds in autumn, or as soon as gathered, or received from the Continent; choosing a moist rich soil, and a shady situation, and covering them

as lightly as those of the birch or alder are covered, or beating them in with the back of the spade, and not covering them at all; and protecting the beds with litter of some sort, to exclude the frost. (See p. 1685.) The plants will come up the following spring, and, after two years' growth, will be fit for transplanting into nursery lines, there to undergo the usual routine of nursery culture. (See *P. occidentalis*, *Propagation and Culture*.) Cuttings of the Oriental plane, put in in autumn, in a sandy soil, and in a shady situation, will root, but by no means readily; and, therefore, this method is never resorted to by nurserymen. Layers soonest produce saleable plants; and this mode is almost universally adopted, both in Britain and on the Continent. Layers may be made either in autumn or spring: they root freely, producing shoots 3 ft. or 4 ft. in length the first year; and they are ready to be taken off the following autumn. After being one year in the nursery lines, they may be removed to where they are finally to remain; but, if they are to be planted as single trees, and separately fenced, they should be kept in the nursery till they are 15 ft. or 20 ft. high; care being taken to transplant them every year, and to prune their heads in proportion to the losses sustained by their roots in transplanting. Trees so treated will seldom fail when removed to their final situation; but, if there should be any doubt of this, it may be removed, by cutting off the greater number of side branches from the head, shortening the leading shoot, and coating the wounds over with a composition, to exclude the air.

Statistics. Recorded Trees. In addition to the remarkable trees recorded by the Greek and Roman authors (see p. 2037.), the following may be noticed as having flourished in more modern times. Hasselquist mentions a plane tree in the island of Cos (now Stanchio), the circumference of the trunk of which was 25 British feet. He brought a specimen of the tree to Linnæus; and it is now in the Linnæan herbarium. The celebrated plane tree at Burykiddre, or the Great Valley, is mentioned by Olivier, and, after him, by Poqueville, Hobbouse, and various other writers. Olivier says that the trunk presents the appearance of 7 or 8 trees, having a common origin, which he supposes to be the stool of a decayed tree, and which were all connected at their base. Dr. Walsh, who measured the tree in 1831, found the trunk 141 ft. in circumference at the base, and its branches covering a space 130 ft. in diameter. The trunk, he says, "divides into 14 branches, some of which issue from below the present surface of the soil, and some do not divide till they rise 7 ft. or 8 ft. above it. One of the largest is hollowed out by fire, and affords a cabin to shelter a husbandman. The tree, if it can be considered a single plant, is certainly the largest in the world. Among other travellers who notice it is a Frenchman who describes it, with some truth, as 'un temple de verdure, surmonté d'un dôme prêt à toucher les nues.' When the Turks encamp in this valley, the hollow of this great tree affords a magnificent tent to the seraskier who commands them, with all his officers. But what renders the tree an object of more than usual interest is, that M. De Candolle conjectures that it must be more than 2000 years old. Though it has become such an object of admiration to recent travellers, Gillies takes no notice of it, nor even Tournefort, whose botanical pursuits would naturally have led him to do so." (*Residence in Constantinople*, &c.) Near Notizza, the Ægium of the ancients, on the beach of the stream Sellaus, Hobbouse found "the enormous plane tree which was notorious in the time of Chandler. One of its largest branches, as thick as the trunk of most trees, has lately fallen off; and many of the other boughs are supported by long beams of wood." (*Journa. of Travels in Albania*, p. 229.) The same tree is described by Buckingham as being 15 ft. in diameter, and 100 ft. in height, and as being covered with rich and luxuriant foliage. The plane tree at Les Court is mentioned by Evelyn as having been seen by him on September 16. 1683. A portrait of this tree was published by Strutt, in his *Sylva Britannica*, p. 112. The circumference of the trunk, when measured by Mr. Strutt, was 14 ft. 8 in. at 6 ft. from the ground; the height was 65 ft.; and it contained 301 cubic feet of timber. In Manning and Bray's *Survey*, vol. iii. p. 136., several large Oriental planes are mentioned as growing at the seat of Sir William Temple, at Moor Park, near Faraaham; but, being afterwards destroyed by the severe frost of 1808 and 1809, it is more than probable they were Occidental planes. Dr. Walker mentions several large plane trees as existing in Scotland in 1777; using the term sycamore, at that time generally applied to the *Platanus* in Scotland. One of the largest was in the Isle of Bute, at Mount Stewart; where, on the 1st of September, 1799, the trunk measured 6 ft. 10 in. in circumference at 4 ft. from the ground. This tree was planted by the Earl of Bute in 1738. In the year 1771, there was a row of *Platanus* along the side of one of the streets in Robson, which grew there like willows; but, before the year 1774, they were all removed, to give place to new buildings. In Belgium, near Ghent, in the grounds of the villa of M. Meulemeester, Dr. Neill found, in 1817, an avenue of Oriental planes, the finest he ever saw. The trees were, in general, about 70 ft. high, trained up to the height of about 40 ft., and the trunks quite clean and healthy.

Existing Trees. In the environs of London, at Mount Grove, Hampstead, 80 years old, it is 77 ft. high, the diameter of the trunk 4 ft. 4 in., and of the head 90 ft.; in the Chelsea Botanic Garden, it is upwards of 70 ft. high; at Lambeth, the one before mentioned, 90 ft. high; and one in the grounds of the Duke of Devonshire's villa, at Chiswick, not very high, but with a head 100 ft. in diameter. South of London: in Dorsetshire, at Melbury Park, 25 years planted, it is 44 ft. high, the diameter of the trunk 3 ft. 3 in., and that of the head 30 ft.: in Hampshire, at Alresford, 41 years planted, it is 76 ft. high, the diameter of the trunk 2 ft. 6 in., and that of the head 52 ft.: in Somersetshire, at Nettlescombe, 60 years planted, it is 64 ft. high, the diameter of the trunk 2 ft.: in Sussex, at West Dean, 15 years planted, it is 36 ft. high: in Wiltshire, at Wardour Castle, 40 years planted, it is 40 ft. high, the diameter of the trunk 2 ft. 6 in., and that of the head 58 ft.; at Longford Castle it is 60 ft. high, the diameter of the trunk 4 ft. 6 in., and that of the head 64 ft. North of London: in Berkshire, at White Knights, 45 years planted, it is 26 ft. high; in Buckinghamshire, at Temple House, 13 years planted, it is 30 ft. high: in Pembrokeshire, at Stackpole Court, 40 years planted, it is 60 ft. high, the diameter of the trunk 2 ft. 6 in., and that of the head 30 ft.: in Shropshire, at Willey Park, 15 years planted, it is 26 ft. high: in Wiltshire, at Croome, 55 years planted, it is 70 ft. high, the diameter of the trunk 2 ft., and of

the head 60 ft. : in Yorkshire, at Grimston, 14 years planted, it is 45 ft. high.—In Scotland. In the environs of Edinburgh, at Gosford House, 30 years old, it is 25 ft. high, with a trunk 2 ft. 3 in. in circumference : at Ebel, it is 64 ft. high : in Banffshire, at Gordon Castle, 66 ft. high, the diameter of the trunk 3 ft. 2 in., and that of the head 6½ ft. : in Ross-shire, at Brahan Castle, 50 ft. high, the diameter of the trunk 2 ft., and of the head 40 ft.—In Ireland. South of Dublin : in Kilkenny, at Woodstock Park, 70 years planted, it is 68 ft. high, the diameter of the trunk 3 ft., and of the head 48 ft. : in Tipperary, in Higgins's Nursery, Clonmel, 50 years planted, it is 70 ft. high, the diameter of the trunk 3 ft., and that of the head 63 ft. (North of Dublin : in the county of Down, at Castle Ward, 80 years planted, it is 32 ft. high, the diameter of the trunk 2 ft., and that of the head 54 ft. : in Louth, at Oriel Temple, 36 years planted, it is 34 ft. high, the diameter of the trunk 1 ft., and that of the head 28 ft.—In France, in the Jardin des Plantes, 130 years old, it is 74 ft. high, the diameter of the trunk 3 ft. 8 in.—In Hanover, at Harbecke, 8 years planted, it is 7 ft. high : in the Botanic Garden, Göttingen, 20 years planted, it is 12 ft. high.—In Austria, at Vienna, in the University Botanic Garden, 35 years planted, it is 36 ft. high, the diameter of the trunk 13 in. : in Rosenthal's Nursery, 20 years planted, it is 37 ft. high, the diameter of the trunk 1 ft., and of the head 24 ft. : at Brick on the Leytha, 15 years old, it is 18 ft. high.—In Sweden, at Lund, in the Botanic Garden, 4½ ft. high, the diameter of the trunk 1½ in., and that of the head 28 ft.—In Italy, in Lombardy, at Monza, 29 years planted, it is 80 ft. high, the diameter of the trunk 2 ft. 6 in., and of the head 106 ft.

Commercial Statistics. Plants raised from layers of the species, in the London nurseries, are 1s. each ; and of *P. o. cuneata*, 1s. 6d. each : at Bollwyller, from 1 franc to 1 franc and 50 cents ; and at New York, 50 cents.

TABLE 2. *P. OCCIDENTALIS* L. The Western Plane.

Identification. Willd. Sp. Pl., 4, 475 ; Hort. Cliff., 78 ; Roy Lugd., 7 ; Grœv. Virg., 151 ; Kalm It., 2, p. 198 ; Mill. Dict., No. 2 ; Du Roy Harbk., 2, p. 134 ; Medic. in Obs. Soc. (Econ. Lutr., 1774, p. 239 ; N. Du Ham. 2, p. 5.

Synonymes. *P. occidentalis* seu virginiana Park. Theatr., 1467 ; Du Ham. Arb., t. 35 ; Button-wood, Water Beech, Sycamore, Cotton Tree, Amer. ; Platane de Virginie, Fr.
Distinctions. Button-wood refers to the smooth round heads of flowers, which resemble the globular buttons formerly in use, and still seen in some military costumes ; Sycamore to the resemblance of the leaves to those of that tree ; and Cotton Tree to the down detached in the course of the summer from the leaves.

Expressions. Cat. Carol., t. 56 ; Dend. Brit., t. 100 ; Michx. N. Amer. Syl., 2, t. 63 ; our *Ag.* 1956 ; and the plate of this species in our last Volume. In *Ag.* 1969, *a* represents a transverse section of the female catkin in flower ; *b*, the same in fruit ; *c*, the female flower and scale ; *d*, the stamen and scale ; *e*, the longitudinal section of a seed ; and *f*, an entire seed.

Spec. Char., &c. Leaves 5-angled, obsolete lobed, dentate, wedge-shaped at the base ; downy beneath. (*Willd.*) A tree, a native of North America, where it grows to the height of 70 ft. or 80 ft. ; with a widely spreading head. It flowers in May ; and ripens its seeds in October. Introduced before 1636. The Occidental plane is easily distinguished from the Oriental plane, by its leaves being larger, and less deeply lobed (see fig. 1951. *a*. in p. 2033.) ; and by the red colour of their petioles ; the petioles of *P. orientalis* being green. The fruit is, also, much larger, and rather smoother.

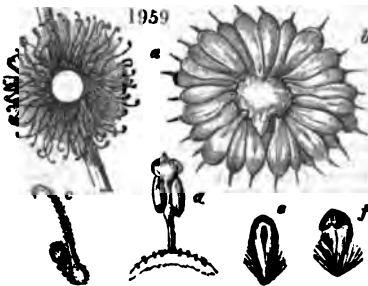

Variety.

T P. o. 2 tortuosa ; Platane tortillard, Fr.—This variety, according to Boec, was found by Malesherbes in a bed of seedlings. The stem is full of knots, which render the fibres tortuous, and, consequently, difficult to split, like those of the *Ulmus campestris* tortuosa, mentioned in p. 1376 ; and, like that variety, it is thought to be suitable for the nave of wheels. We have not heard of its being in cultivation in French nurseries. In the *Notizen Du Hamel*, it is stated that M. Daubenton, fils, who raised many plants of the Occidental platanus for seed, found the varieties almost infinite.

Description, &c. The American, or Western, plane, in magnitude and general appearance, bears so close a resemblance to the Oriental plane, that, by many persons, they are confounded together. The former, however, is a larger tree ; of much more rapid growth than the Oriental plane ; with broader and less deeply cut leaves, red petioles, and fruit comparatively smooth, and considerably larger. The bark is said to scale off in larger pieces, and the wood to be more curiously veined. In all other respects, the descriptive particulars of both trees are the same. The rate of growth of *P. occidentalis*, when placed near water, is so rapid, that in 10 years it will attain the height of 40 ft. ; and a tree in the Palace Garden at Lambeth, near a pond, in 20 years had at-

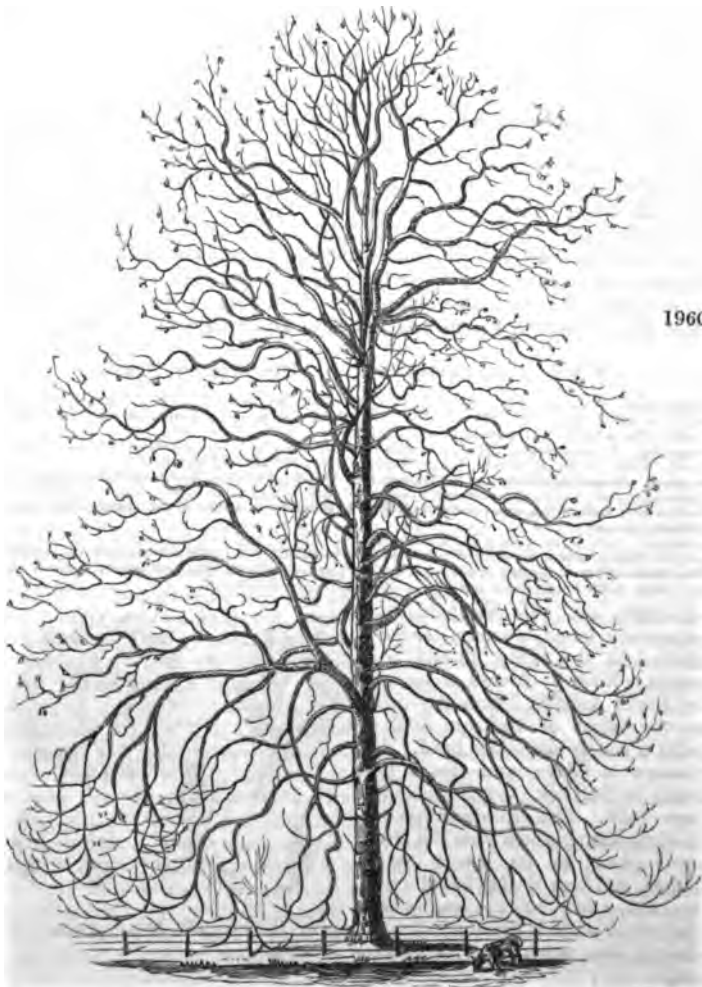

tained the height of 80 ft.; with a trunk 8 ft. in circumference at 3 ft. from the ground; and the diameter of the head 48 ft. This was in 1817. (See Neill's *Hort. Tour*, p. 9.) The palace gardens at Lambeth have, since that period, been surrounded by numerous buildings, including several manufactories, which have killed many trees, and injured all of them, more or less, by their smoke. Nevertheless, in May, 1837, when we saw this tree, and had the portrait, *fig. 1960.*, taken of it, it was estimated at upwards of 100 ft. in height. A tree in the Chelsea Botanic Garden, planted by Miller, in a confined situation, but having its roots within reach of the Thames, is estimated at upwards of 115 ft. in height, with a trunk nearly 5 ft. in diameter at a foot from the ground. When cut down, the Western plane stoles like the other species, and produces much more vigorous shoots; but, as these seldom ripen completely, they are very liable to be injured by frost. Varennes de Fenille mentions two trees of the American plane, which, after being 28 years planted, measured, the one 5 ft. 7 in., and the other 5 ft. 5 in., at 2 ft.

from the ground, or about 1 ft. 10 in. in diameter; which gives nine lines and a half, or more than three quarters of an inch, of increase annually.

Geography. The American plane is found over an immense tract of land in North America, comprising the Atlantic and western states, and extending beyond the Mississippi. "The nature of the button-wood," says Michaux, "confines it to moist and cool grounds, where the soil is loose, deep, and fertile; the luxuriance of its vegetation depending on a combination of these circumstances. It is never found upon dry lands of an irregular surface, among white and red oaks and walnuts; it is also more rare in the mountainous tract of the Alleghanies than in the flat country. It is remarked, in that part of Virginia which lies upon the road from Baltimore to Petersburg, that, though the button-wood is abundant in the swamps, its growth is stunted; and that its trunk does not, in general, exceed 8 in. or 10 in. in diameter. Farther south, in the lower parts of the Carolinas and of Georgia, it is not abundant even on the sides of the rivers; and is not seen in the branch swamps, already mentioned, which intersect the pine barrens, and which are principally covered with the small magnolia (*Magnolia glauca*), the red bay (*Laurus carolinensis*), the loblolly bay (*Gordonia lasianthus*), the red maple (*Acer rubrum*), &c. The reason that the button-wood is not found in these small marshes is, perhaps, that the layer of vegetable mould, which is black and always miry, is not sufficiently thick and substantial to support its growth; and that the heat, in this part of the southern states, is excessive. The button-wood is in no part of North America more abundant and more vigorous than along the great rivers of Pennsylvania and of Virginia; though in the more fertile valleys of the west its vegetation is, perhaps, still more luxuriant; especially on the banks of the Ohio, and of the rivers which empty into it. The bottoms which are watered by these rivers are covered with dark forests, composed of trees of an extraordinary size. The soil is very deep, loose, of a brown colour, and unctuous to the touch: it appears to have been formed by the slime deposited in the course of ages, at the annual overflowing of the rivers. The leaves, which every autumn form a thick layer upon the surface, and the old trees, that fall by the weight of years, and crumble into vegetable mould, give to this soil, already so fertile, a degree of fecundity which is without example in Europe, and which is manifested by prodigies of vegetation. The margin of the great rivers of the West is occupied by the willow, after which comes the white maple (*Acer eriocarpum*), and next the button-wood; but this arrangement is not uniformly observed; and the maple alone, or, as it more frequently happens, mingled with the button-wood, sometimes grows upon the brink. Among the trees which compose these forests, the three species mentioned are least liable to injury from the continued presence of water; and, by their position, they are exposed to have their bases every year inundated by the swelling of the rivers. In these situations, the button-wood is constantly found to be the loftiest and largest tree of the United States." (*North Amer. Syl.*, ii. p. 56.)

History. In the Atlantic states, this tree is commonly known by the name of button-wood; and sometimes, in Virginia, by that of water beech. On the banks of the Ohio, and in the states of Kentucky and Tennessee, it is most frequently called sycamore, and by some persons plane, tree. The French of Canada and of Upper Louisiana give it the name of the cotton tree. The first of these denominations appears to be the most widely diffused, and, in fact, to be that by which the tree is most generally known in America. The name cotton tree alludes to the thick down which covers the under surface of the leaves when they first expand, and which becomes gradually detached from them in the course of the summer. In some parts of the United States, where the tree is very abundant, the inhabitants, according to Michaux, regard it with dread, as they think this down, detached and floating in the air, has a tendency to produce irritation of the lungs, and, finally, consumption. The American plane was one of the trees discovered and figured by Catesby in his *Natural History of Carolina* (i. t. 56.); and it was introduced about 1630,

by Mr. John Tradescant, in whose garden two small plants were growing in 1636, when Johnson published his edition of Gerard's *Herball*. These plants were again spoken of by Parkinson in 1640. It was afterwards so much propagated, that, in Evelyn's time, it had become more common than *P. orientalis*. The tree propagating readily by cuttings, and growing with great rapidity, was, in Miller's time, and indeed till 1809, considered hardier than the Oriental plane; but, in the May of that year (not June, as stated in the *Planter's Kalendar*), a severe frost killed back the young shoots of many of the largest plants of this species in England; particularly those in Richmond Park, at Kew, at Syon House, at Stowe, at Pain's Hill, and at Claremont. There are still large trees, however, in the Chelsea Garden, in the grounds of Lambeth Palace, at Deepdene, and various other places. In Scotland, where trees of both *P. orientalis* and *P. occidentalis* were standing near each other, the former escaped; but the latter were generally injured, and many either died the same year, or, after making an ineffectual effort to push, in the summer of the year following, viz. 1810. "It is very singular," Sang observes, "that of the *P. occidentalis* the largest trees only were killed. Trees of from 20 ft. to 25 ft. in height were little hurt; and smaller ones not at all, at least in every instance that came under our observation. We did not observe, or hear," he adds, "of a single Oriental plane being injured in any part of the country." (*Plant. Kal.*, p. 99.) The severe winter of 1813-14 destroyed a number of the Occidental planes which escaped the severe frost of 1809, so that the tree is at present comparatively rare throughout Britain. An account of the damage done to the Occidental plane tree, in different parts of England, in 1809, will be found in the *Gentleman's Magazine* for 1810 and 1813; from which it appears, that on the 25th of January, 1809, there was a great flood, occasioned by a sudden thaw; and in the March and April following there was very mild weather, which caused the plane trees to put out their leaves earlier than usual. This was succeeded by a severe frost in the beginning of May, which so far injured the trees, that they appeared sickly throughout all the summer; and in the spring of 1810 they almost all died.

Properties and Uses. The wood of the American plane, according to Michaux, in seasoning becomes of a dull red; but its grain is fine and close, and it is susceptible of a brighter polish than the wood of the beech, to which it bears considerable resemblance. Its concentric circles are divided into numerous sections, by fine medullary rays extending from the centre to the circumference. When the trunk is sawn in a slanting direction, these rays have a remarkable appearance. The cabinet-makers of Philadelphia, however, rarely use the wood, on account of its warping; but it is sometimes employed for bedsteads, which retain their natural colour, and are coated with varnish. The wood soon decays when exposed to the weather. Like the wood of the beech, it shrinks very much in drying, and is very apt to split. As fuel, it does not produce a very lively flame, nor does it yield much charcoal. It contains a great deal more sap wood than the beech; so much so, that a parallelopipedon of green platanus 6 in. square weighed 18 lb. 10 oz.; while a piece of beech of the same size only weighed 15 lb. 13 oz. The platanus, in drying, lost 6 lb. 15 oz., and the beech only 5 lb. 9 oz.; which gives 5 lb. 6 oz. of difference in the cubic foot. The platanus weighs, when dry, 51 lb. 8 oz. per cubic foot; and in that state it is easy to work, cutting readily in every direction, and is therefore well adapted for cabinet-work. In Britain, the principal use of the platanus is as an ornamental tree; for which purpose it has all those qualities to recommend it which we have attributed to the Oriental plane, except that it is much less hardy, and, to attain a large size, requires the presence of water. As a picturesque tree, the Occidental plane is thus characterised by Gilpin. He places it after the oak, the ash, the elm, the beech, and the hornbeam, which he considers as deciduous trees of the first rank; saying of both species of platanus, that, though neither so beautiful nor so characteristic as the first-mentioned trees, they are yet worth the

notice of the picturesque eye. "The Occidental plane has a very picturesque stem. It is smooth, and of a light ash-colour, and has the property of throwing off its bark in scales; thus naturally cleansing itself, at least its larger boughs, from moss and other parasitical encumbrances. This would be no recommendation of it in a picturesque light, if the removal of these encumbrances did not substitute as great a beauty in their room. These scales are very irregular, falling off sometimes in one part, and sometimes in another; and, as the under bark is, immediately after its excoriation, of a lighter hue than the upper, it offers to the pencil those smart touches which have so much effect in painting. These flakes, however, would be more beautiful if they fell off in a circular form, instead of a perpendicular one: they would correspond and unite better with the circular form of the bole. No tree forms a more pleasing shade than the Occidental plane. It is full-leaved; and its leaf is large, smooth, of a fine texture, and seldom injured by insects. Its lower branches, shooting horizontally, soon take a direction to the ground; and the spray seems more sedulous than that of any tree we have, by twisting about in various forms, to fill up every little vacuity with shade. At the same time, it must be owned, the twisting of its branches is a disadvantage to this tree, as we have just observed it is to the beech, when it is stripped of its leaves and reduced to a skeleton. It has not the natural appearance which the spray of the oak, and that of many other trees, discover in winter; nor, indeed, does its foliage, from the largeness of the leaf, and the mode of its growth, make the most picturesque appearance in summer. One of the finest Occidental planes I am acquainted with stands in my own garden at Vicar's Hill; where its boughs, feathering to the ground, form a canopy of above 50 ft. in diameter. The Oriental plane is a tree nearly of the same kind, only its leaf is more palmated; nor has it so great a disposition to overshadow the ground as the Occidental plane; at least, I never saw any in our climate form so noble a shade, though in the East it is esteemed among the most shady and most magnificent of trees." (*Rem. on For. Scen.*, vol. i. p. 53.)

Soil, Situation, Propagation, &c. What has been said on these subjects as applicable to *P. orientalis* is equally so to this species; the chief difference being, that *P. occidentalis* strikes very readily from cuttings, and is much more like the willow, in requiring, when it is intended to attain a large size, to be planted near water. It is sometimes raised from seeds imported from America. A great many plants were raised in this way by Mr. Cobbett, from 1826 to 1830. The seed is imported in the globular catkins, or balls, which Cobbett broke to pieces by rubbing them with the hand to separate the down or wool, as he calls it, from the seeds. The latter, being sifted out of the wool, he soaked in lukewarm water for 48 hours; he then "took the seeds out of the water, and mixed them with finely sifted fresh earth, 10 gallons of earth to one gallon of seeds; put the mixture upon a smooth place on the bare ground; turned and remixed the heap every day for four or five days, keeping it covered with a mat whenever the turning and mixing was not going on; and as soon as a root began to appear here and there, sowed the seeds upon a bed of sifted earth, mixed with the sifted mould, just as they came out of the heap." (*Woodlands*, § 473.) The seeds received no other covering than the mould with which they were mixed: they were watered every evening with a fine-rosed watering-pot; and securely shaded from the sun by mats, kept from touching the ground by hoops. These mats were removed every evening about an hour after sunset, and were put on again in the morning by sunrise. In about a week, most of the seeds had germinated, and in a short time afterwards the seed leaves appeared. Being gradually inured to the sunshine, till they were hardy enough to be exposed during the whole of the day, by the month of October their growth was finished, and the wood ripe; and next summer they were fit to transplant into nursery lines. As the Occidental plane is very tender when young, Mr. Cobbett did not commence his operations with the seed till April; and, consequently, his plants were small in October; but, by sowing in frames in February, as is the prac-

tice with nurserymen who raise this species from seed, the plants, by autumn, with careful treatment, will be 2 ft. or 3 ft. in height.

Statistics. Recorded Trees. On a little island in the Ohio, 15 miles above the mouth of the Muskingum, the elder Michaux measured a button-wood tree, which, at 5 ft. from the ground, was 40 ft. 4 in. in circumference. Twenty years before, General Washington had measured the same tree, and found it to be nearly the same size. In 1802, the younger Michaux found, on the right bank of the same river (the Ohio), about 36 miles from Manitta, a plane tree, the base of which was swollen in an extraordinary manner; and which, at 4 ft. from the ground, measured 47 ft. in circumference. This tree, which exhibited the most vigorous vegetation, began to ramify at 20 ft. from the ground; but Michaux saw several trees which had not a single branch till they had attained the height of 60 ft. or 70 ft. In the notes to Hunter's *Evelyn*, an Occidental plane at Shadwell Lodge is recorded as remarkable for its speedy growth. When planted, in April, 1744, it was 8 ft. high; and, when measured in 1775, 31 years afterwards, it was 65 ft. 9 in. high, with a clear trunk of 20 ft.; which, at 6 in. from the ground, measured 7 ft. 9 in. in circumference; and at 20 ft., 4 ft. 6 in. At Biel, in East Lothian, there was, in 1812, an Occidental plane near a fishpond, 45 ft. high, with a trunk 7 ft. 1 in. in circumference at 4 ft. from the ground. Another tree, near the same pond, measured 8 ft. 5 in. in circumference. (*Plant. Kal.*, p. 568.)

Existing Trees. In the environs of London, in the gardens of the Archbishopal Palace of Lambeth; in the Chelsea Botanic Garden, and at Mount Grove, are the large trees already mentioned. South of London: in Dorsetshire, at Melbury Park, 100 years old, it is 66 ft. high, the diameter of the trunk 3 ft., and that of the head 66 ft.; in Hampshire, at Testwood, 70 years planted, it is 80 ft. high, the diameter of the trunk 4 ft. 6 in., and of the head 60 ft.; in Wiltshire, at Wardour Castle, 40 years planted, it is 40 ft. high, the diameter of the trunk 3 ft. 6 in., and of the head 45 ft. North of London: in Bedfordshire, at Amptill, 85 years planted, it is 50 ft. high, the diameter of the trunk 2 ft. 6 in., and of the head 70 ft.; in Berkshire, at White Knights, 26 years planted, it is 45 ft. high; in Essex, at Audley End, 60 years planted, it is 70 ft. high, the circumference of the trunk 10 ft. 10 in., and of the head 69 ft.; in Gloucestershire, at Doddington, it is 60 ft. high, the diameter of the trunk 3 ft., and that of the head 198 ft.; in Herefordshire, at Eastnor Castle, 16 years planted, it is 40 ft. high, the diameter of the trunk 1 ft.; at Haffield, 15 years planted, it is 45 ft. high, the diameter of the trunk 9 in., and of the head 29 ft.; in Lancashire, at Latham House, 50 years planted, it is 49 ft. high, the diameter of the trunk 2 ft., and of the head 42 ft.; in Nottinghamshire, at Clumber Park, it is 64 ft. high, the diameter of the trunk 4 ft. 10 in., and of the head 66 ft.; in Pembrokeshire, at Stackpole Court, 40 years planted, it is 50 ft. high, the diameter of the trunk 2 ft., and of the head 40 ft.; in Radnorshire, at Maeslaugh Castle, it is 70 ft. high, the diameter of the trunk 2 ft., and of the head 54 ft.; in Shropshire, at Hardwicke Grange, 4 years planted, it is 12 ft. high; in Staffordshire, at Treunham, it is 60 ft. high, the diameter of the trunk 2 ft. 6 in., and of the head 40 ft.; in Suffolk, at Ampton Hall, 16 years planted, it is 30 ft. high; in Worcestershire, at Croome, 75 years planted, it is 100 ft. high, the diameter of the trunk 3 ft. 6 in., and that of the head 60 ft.; in Yorkshire, at Grimston, 14 years planted, it is 30 ft. high, with a trunk 1 ft. 8 in. in diameter. In the environs of Edinburgh, at Gosford House, 24 years old, it is 35 ft. high, with a trunk 1 ft. 8 in. in diameter. North of Edinburgh: in Argyllshire, at Toward Castle, 13 years planted, it is 30 ft. high, with a trunk 7 in. in diameter; in Banffshire, at Cullen House, it is 62 ft. high, the diameter of the trunk 3 ft. 4 in., and that of the head 47 ft.; in Forfarshire, at Courtachy Castle, 102 years old, it is 72 ft. high, the diameter of the trunk 3 ft., and of the head 50 ft.; another, 80 years planted, is 70 ft. high, the diameter of the trunk 2 ft., and of the head 45 ft.—In Ireland. In the environs of Dublin, at Cypress Grove, it is 36 ft. high, the diameter of the trunk 2 ft. 9 in., and of the head 38 ft.; at Terenure, 15 years planted, it is 20 ft. high. North of Dublin: in the county of Down, at Castle Ward, 130 years old, it is 65 ft. high, the diameter of the trunk 4 ft. 3 in., and of the head 52 ft.; in Galway, at Coole, it is 39 ft. high, the diameter of the trunk 3 ft., and that of the head 42 ft.—In France, at the Botanic Garden at Toulon, 18 years planted, it is 40 ft. high, the circumference of the trunk 3 ft. 2 in.; near Nantes, 80 years old, it is 70 ft. high; at Colombe, near Metz, 70 years old, it is 60 ft. high, the diameter of the trunk 2 ft. 4 in., and that of the space covered by the branches 69 ft.; in the Botanic Garden at Avranches, 22 years planted, it is 40 ft. high, the circumference of the trunk 2 ft., and the diameter of the head 20 ft.—In Hanover, in the Botanic Garden at Göttingen, are several trees, about 10 years planted, and from 25 ft. to 30 ft. high.—In Cassel, at Wilhelmshoe, 50 years planted, it is 22 ft. high, and the diameter of the trunk 4 ft. 6 in.—In Austria, at Vienna, in the University Botanic Garden, 40 years old, it is 30 ft. high, the diameter of the trunk 1 ft., and of the head 20 ft.; in Rosenthal's Nursery, 20 years planted, it is 30 ft. high, the diameter of the trunk 8 in., and of the head 24 ft.; at Brück on the Leytha, 45 years planted, it is 26 ft. high, the diameter of the trunk 3 ft., and of the head 70 ft.—In Bavaria, at Munich, in the English Garden, 40 years planted, it is 60 ft. high, the diameter of the trunk 1 ft. 8 in., and of the head 30 ft.—In Prussia, at Berlin, at Sans Souci, 90 years old, it is 20 ft. high, the diameter of the trunk 3 ft. 6 in., and of the head 34 ft.; in the Pfauen-Insel, 40 years planted, it is 48 ft. high, the diameter of the trunk 1 ft., and of the head 30 ft.—In Sweden, in the Botanic Garden at Lund, 42 ft. high, the diameter of the trunk 1 ft., and of the head 36 ft.—In Italy, in Lombardy, at Monza, 29 years planted, it is 80 ft. high, the diameter of the trunk 2 ft. 6 in., and of the head 90 ft.

Commercial Statistics. Plants, in the London nurseries, from 3 ft. to 4 ft. high, are 9d. each, or 20s. per hundred; and seeds are 1s. per quart. At Bollwyller, plants are from 1 franc to 1 franc and 50 cents each; and at New York they are 25 cents each.

CHAP. CVIII.

THE HARDY LIGNEOUS PLANTS OF THE ORDER BALSAMACEÆ.

LIQUIDAMBAR L. Flowers unisexual; those of the two sexes upon one plant, disposed in capitate catkins.—Male catkins in an upright raceme, each roundish, constituted of numerous stamens, mixed with a few minute scales, disposed upon a connate receptacle. Filaments very short.—Female

catkins solitary, situated below the male, and upon longer stalks; globose, consisting of numerous ovaries, each surrounded by a few scales, and having two cells. Styles 2, long. Fruit a kind of cone, composed of indurated connected scales, in the cavities of which lie obconical, 2-lobed, 2-celled capsules. Seeds numerous, or solitary by abortion; compressed, membranous, winged, attached internally to the middle of the dissepiments in a peltate manner. Embryo inverted in the midst of albumen. — Species 3. Inhabiting the warmer parts of North America, and Mexico, the Levant, and the tropics of India. Deciduous trees, yielding balsam. Leaves alternate, simple, or lobed, with glandular serratures at the edges. Stipules deciduous. (*Blume*, as quoted in *Lindl. Nat. Syst. Bot.*, and *N. Du Ham.* For a long time, only two species were known to European botanists; one a native of Asia Minor, the other of the temperate parts of North America; but *Blume* states that there is a third, which inhabits the tropics of the south of Asia, and more particularly Java, even reaching as far as New Guinea. (*Blume Fl. Jav.*)

GENUS I.



LIQUIDA'MBAR L. THE LIQUIDAMBAR. *Lin. Syst. Monœ'cia*
Polyándria.

Identification. *Lin. Gen.*, 1076; *Reich.*, 1174; *Schreb.*, 1452; *Clayt. Mitch.*, 12; *Gartn.*, t. 90; *Juss.*, 410.

Synonymes. *Altingia Noronha*; *Liquidambar, Fr.*; *Ambarbaum, Ger.*

Derivation. From *liquidus*, liquid, and *ambar*, amber; the plants exuding a liquid gum.

Description, &c. Deciduous trees, natives of North America and the Levant; cultivated in British pleasure-grounds for the beauty and fragrance of their foliage.

† 1. L. STYRACIFLUA L. The Sweet Gum Liquidambar.

Identification. *Lin. Sp.*, 1418; *Alt. Hort. Kew.*, 3. p. 365; *Reich.*, 4. p. 171; *Mat. Med.*, 204; *Gartn. Fruct.*, 2. p. 58; *Kalm Itin.*, 2. p. 102; *Du Roy Hartk.*, 1. p. 369; *Blackw.*, t. 485; *Michx. Arb.*, 3. p. 194; *N. Du Ham.*, 2. p. 42.

Synonymes. *Liquidambar arbor Pluk. Alm.*, 224. t. 42. f. 6; *Cat. Car.*, 2. p. 65; *Du Ham. Arb.*, 1. t. 139; *Styrax Aceris folio Rati Hist.*, 1481; *Liquidambar résineux, Copalme de l'Amérique, Liquidambar Copal, Fr.*; *Fleischer Ambarbaum, Ger.*

Engravings. *Blackw.*, t. 485; *Pluk. Alm.*, t. 42. f. 6; *Cat. Car.*, t. 65; *Du Ham. Arb.*, 1. t. 139; *Michx. Arb.*, 3. t. 4; and our *fig.* 1961; and the plates of this tree in our last Volume.

Spec. Char., &c. Leaves palmately lobed, with the sinuses at the base of the veins villose. (*Willd.*) A deciduous tree, a native of North America, where it grows from 30 ft. to 50 ft. high, and flowers in March or April.

Description, &c. The liquidambar generally forms a branching tree, having very much the appearance of a maple; and varying from 30 ft. to 50 ft. in height, with a trunk from 5 ft. or 6 ft., to 12 ft. or 15 ft. in circumference. According to *Michaux*, in America, when grown among other trees, it has a perfectly straight trunk, nearly uniform in thickness, to the height of 30 ft. or 40 ft. before it begins to divide into branches. In Europe, it seldom exceeds 40 ft. in height. The bark of old trees is thick, and deeply furrowed; but on young trees it is comparatively smooth. On dry gravelly soil, it does not attain a greater height than 15 ft. or 20 ft.; and its secondary branches become covered with a dry flaky bark, the plates of which are attached at the edge, in-



stead of the face, as is the case with the bark of most other trees. The bark of the young shoots is smooth, and of a yellowish green colour. The leaves are alternate, and on rather long petioles; they vary in size from 3 in. to 6 in. in diameter; and they are palmate; that is, they are divided into five deeply cut lobes, which are finely denticulated at the edge. When they first expand, a small tuft of reddish down is perceptible at the back of the middle rib of each leaf. "In warm weather, a viscous substance exudes from the leaves of those trees which have grown on dry ground; and, when bruised, they emit a sensible aromatic odour." (*Michaux.*) The male and female catkins, which appear about March or April, are on different branches of the same tree. The male are oval, and about 1½ in. in length; the female ones are not conspicuous. "The fruit is globular, and bristling with points. When arrived at maturity, it is about 1½ in. in diameter, and is suspended by a flexible pedicel, 1 in. or 2 in. long: the globes, which are green at first, and afterwards yellow, are composed of a great number of closely connected capsules. At the beginning of autumn, these capsules open, and give liberty to the seeds, which are small, blackish, oblong, compressed, and surmounted by a wing. Each capsule contains one or two seeds, united with a number of minute bodies, incapable of germination." (*Id.*) The leaves die off of an intensely deep purplish red, more or less mixed with orange, and with some leaves entirely of that colour. They hang on the trees till the first frosts, when they drop off simultaneously. The rate of growth of this tree, in the climate of London, is from 8 ft. to 10 ft. in 10 years from the seed; and in 20 years it will attain the height of 25 ft. or 30 ft., and flower and ripen fruit. In good soil, and sheltered situations, the tree will attain the height of upwards of 60 ft., there being trees exceeding this size at Woburn Farm, Chertsey, and at Strathfieldsaye. These trees flower and produce fruit; but it has not been observed whether the seeds arrive at maturity. The longevity of the tree is probably not great, from its growing in marshy situations, and from the want of durability in its wood.

Geography. The liquidambar spreads through nearly two thirds of the United States, and through a great part of Mexico. In North America, its most northern point is between Philadelphia and Boston, lat. 43° 30' N.; and it extends westward as far as the Illinois River. "In the middle, western, and southern states," says Michaux, "the sweet gum is sufficiently abundant to be numbered among the most common trees; and it is met with wherever the soil is fertile, cool, and exposed to temporary inundations. In the south, it grows, also, in the great swamps that border the rivers; and there, owing, doubtless, to the mildness of the winters, and the intense heat of the summers, it displays its amplest dimensions." The largest trees grow in moist rich soils; but, where the soil is dry and gravelly, the tree does not attain half its usual size. The largest tree observed by Michaux "was in a swamp five or six miles from Augusta, in Georgia. At 5 ft. from the ground, it was 15 ft. 7 in. in circumference; and its head was broad and spreading in proportion to the size of its trunk. It is found, in the American forests, in company with the chestnut white oak (*Quercus Prinus palustris*), the willow oak (*Q. Phellos*), the wahoo (*Ulmus alata*), the black gum (*Nyssa sylvatica*), the red maple (*Acer rubrum*), the red ash (*Fraxinus tomentosa*), and the black ash (*F. sambucifolia*)." (*Michaux.*) In Mexico, the liquidambar is generally found in moist valleys, where it attains an enormous size.

History. The first record we find of the liquidambar appears to be in a work written by Francis Hernandez, a Spanish naturalist and physician, who was sent out by Philip II. of Spain to examine and describe the natural productions of Spanish America. This work, which professed to be a history of the plants, animals, and minerals of Mexico, was originally published in that country, in Spanish, under the care, and with the name, of Father Ximenes; but it was afterwards republished, in Latin, at Rome, with the name of the real author attached, in 1651. Dr. Hernandez describes the liquidambar, or Xochiochotzo-Quahieliel, as he calls it, as being a large tree, and producing a fragrant gum, which, from its appearance, gave the idea of amber in a

liquid state; whence the Spaniards gave the tree the name of liquidambar. (*Nov. Plant., &c.*, p. 56.) Shortly afterwards, Banister, the missionary collector sent out by Bishop Compton (see p. 44), discovered the tree in North America, and sent home, in 1681, a plant of it to the bishop, whose gardener, the celebrated George London, planted it in the palace gardens at Fulham. In Ray's *Historia Plantarum*, published in 1686, the liquidambar is mentioned under the names of *Styrax liquida*, *Styrax Aceris folio*, and *Styrax arbor virginiana*; but Plukenet, Catesby, and Bauhin, who were all nearly contemporary with Ray, call it by its Spanish name of Liquidambar. The Spanish historian, the Abbé Clavigero, in his *History of Mexico*, gives the following account of this tree:—"The Xochiocotzotl, commonly called Liquidambar, is the liquid storax of the Mexicans. It is a great tree (not a shrub, as Pluche, the author of the *Spectacle de la Nature*, makes it): its leaves are similar to those of the maple tree, indented white on one part, and dark in another, and disposed in threes. The fruit is thorny and round, but polygonous, with the surface and angles yellow. The bark of the tree is in part green, and in part tawny. By incision in the trunk, they extract that precious resin, called by the Spaniards liquidambar, and the oil of the same name, which is still more odorous and estimable. They also obtain liquidambar from a decoction of the branches; but it is inferior to that which distils from the trunk." (*Cullen's Trans. Clav.*, i. p. 33.) The abbé adds that Quilbrahacha, which, he says, was the second name applied by the Mexicans to this tree, signifies "break axe;" a name which seems singularly inappropriate, as, according to most writers, the wood is tender and supple. In England, the tree has been generally included in collections from the time of its introduction; and there are, in consequence, some very fine specimens where it has been planted in a sheltered situation, and in an alluvial soil near water. In Scotland, and the north of Germany, it is somewhat tender; and, north of Berlin, it never attains the size even of a low tree.

Properties and Uses. The wood of the liquidambar is very compact and fine-grained, with only a very thin layer of sap wood. The heart wood is reddish; and, when sawn into boards, it is observed to be marked transversely, and at considerable distances, with blackish belts. As it is very light, and takes a brilliant polish, it is sometimes sawn into excessively thin laminæ, and employed by the cabinet-makers, in New York, for veneering. It is, however, inferior to the wood of the black walnut (*Juglans nigra*), and to that of the wild cherry (*Cerasus virginiana*), both of which are harder, and less easily defaced. As it readily takes a black dye, it is often used, in America, instead of ebony; particularly for picture frames, the balusters of staircases, and to ornament bedsteads. When exposed to the external air, it soon decays. It is little esteemed as fuel, as it gives scarcely any flame; and, in America, it always sells at a lower price than any other kind of firewood. Bosc says, speaking of this tree: "Its wood is too liable to decay to be used for any purpose where it will be exposed to the open air; too brittle to be employed by the carpenter; and too apt to warp to be of any service to the cabinet-maker." The principal product of the liquidambar is its resinous gum. This substance, from its fragrance, was at first supposed to be a kind of balsam, resembling storax; but it was soon found to be a resinous gum, differing from storax in many essential respects. (See *Les Végétaux Résineux, &c.*, ii. p. 337.) On large trees, grown in warm countries, the gum is found in considerable quantities, appearing between the bark and the wood, and exuding from the cracks in the former. This substance, which is in the shops sometimes called the white balsam of Peru, or liquid storax, is, when it first issues from the tree, perfectly fluid and clear; white, with a slight tinge of yellow, quite balsamic, and having a most agreeable fragrance, resembling that of ambergris or styrax. This gum is procured in the greatest abundance in warm countries, and that of commerce is chiefly brought from Mexico. It is considered to be a styptic, and to possess healing and balsamic properties. It is stimulant and aromatic, and has been long used in France as a perfume, especially for gloves.

It possesses nearly the same properties as the balsam of Tolu, and that of Peru (both produced by a tree in Brazil), for which it is often substituted, as well as for storax. The best liquidambar gum is obtained by making incisions in the trunk, and suffering the resin to flow gradually; but an inferior kind is procured by boiling the small branches and leaves, and collecting the balsamic oil which rises from them, and floats on the surface of the water. In England and in North America, very little gum is produced from the trunk of the tree, though a little exudes from the leaves; and Michaux informs us that, in repeated experiments made in Carolina, he was never able to collect more than half an ounce, from a tree 1 ft. in diameter, in a fortnight. In Britain, the principal use of this tree is as an ornament to lawns and pleasure-grounds; in which it has a most striking appearance, when the leaves are dying off in autumn; and it is also very beautiful throughout the summer, from the dark green and glossy surface of its elegantly shaped leaves. When bruised, the leaves are fragrant at all seasons; but in spring, when they are first unfolding, after a warm shower, the surrounding air is filled with their refreshing odour.

Soil, Propagation, &c. The liquidambar has a decided preference for a moist soil, and will only attain a timber-like size in a sheltered situation. In British nurseries, it is generally propagated by layers, which root with tolerable facility, and may be taken off at the end of the first autumn after they have been formed. It is also propagated by seeds imported from America. These are brought over in the catkins, and should not be taken out of them till the time of sowing; because the seeds, like those of the pine and fir tribe, do not keep well when exposed to the air. The round prickly catkins which contain the seeds are hard, and not readily broken with the hand; but, by exposure to the sun, or to fire heat, they crack and open, and the seeds may then be easily shaken out. They may be sown and treated like seeds of the pine and fir tribe; but, unlike them, they lie a year in the ground before coming up. Seedlings generally attain the height of from 5 in. to 8 in. the first year, with numerous fibrous roots. They may either be transplanted that year, or the next, and may afterwards undergo the usual routine culture in nursery lines, till they are wanted for final transplanting.

Accidents, Diseases, and Insects. The wood of the liquidambar being brittle, the branches are liable to be broken off by very high winds; and the wounds left, if not smoothed and protected from the air, will greatly facilitate the rotting of the tree, the timber of which is naturally not durable. In America, several insects feed on the leaves, among which we may mention the green swallow-tailed emperor moth (*Phalœna lûna* *Abb. & Smith*, t. 46., and our fig. 1962.) and the great plane moth (*P. imperatœria* *Abb. & Smith*, t. 55., *Bœmbyx imperialis* *Fab.*). Insects of the former species are not common; but they are very beautiful; the caterpillar being bright orange with yellow spots, and the moth bright yellow and pink. These insects are very difficult to rear, as the moth generally dies in confinement, before depositing her eggs.

Statistics. In the environs of London, at Syon, 59 ft. high, the diameter of the trunk 1 ft. 7 in., and of the head 36 ft.; in the Fulham Nursery, 15 years planted, it is 50 ft. high. South of London: in Devonshire, at Luscombe, 18 years planted, it is 25 ft. high, the diameter of the trunk 6 in., and that of the head 14 ft.: in Hampshire, at Strathfieldsaye, it is 64 ft. high, the diameter of the trunk 2 ft. 6 in., growing in rich soil, not much above the level of the river: in Kent, at Cobham Hall, 25 years planted, it is 36 ft. high, with a trunk 1 ft. 3 in. in diameter: in Surrey, at Farnham Castle, on dry chalky soil, 40 years planted, it is 20 ft. high, with a trunk 1 ft. in diameter; at Woburn Farm, it is upwards of 60 ft. high.: at Ockham Park, 23 years planted, it is 22 ft. high, the diameter of the trunk 10 in., and of the head 15 ft.: in Wiltshire, at Wardour Castle, 30 years planted, it is 25 ft. high, the diameter of the trunk 9 in., and that of the head 8 ft. North of London: in Bedfordshire, at Ampt-hill, 38 years planted, it is 25 ft. high, the diameter of the trunk 1 ft., and of the space covered by the branches 24 ft.: in Cheshire, at Eaton Hall, 13 years planted, it is 12 ft. high, the diameter of the trunk 5 in., and that of the space covered by the branches 10 ft.: in Herefordshire, at Wornleybury, 50 years old, it is 55 ft. high, the circumference of the trunk at the ground 5 ft.: in Monmouthshire, at Tredegar Park, 50 years planted, it is 25 ft. high, the diameter of the trunk 1 ft., and that of the head 50 ft.: in Suffolk, at Ampton Hall, 12 years planted, it is 16 ft. high, the diameter of the trunk 3 in., and of the head 6 ft.: in Warwickshire, at Combe Abbey, it is 37 ft. high, the diameter of the trunk 1 ft. 2 in., and that of the head 21 ft.: in Worcestershire, at Croome, 15 years planted, it is 25 ft. high, the diameter of the trunk 5 in., and that of the head 15 ft.: in Yorkshire, in the Haul Botanic Garden, 12 years planted, it is 50 ft. high, the diameter of the trunk 12 in.—In Scotland. In Lawson's Nursery, Edinburgh, 4 years planted, it is 4 ft. high; the young shoots being often injured by the frost. In Banffshire, at Gordon Castle, 12 years planted, it is 10 ft. high, the diameter of the trunk 4 in. In Fifeshire, at Danbristle Park, 4 years planted, it is 4 ft. 6 in. high, the diameter

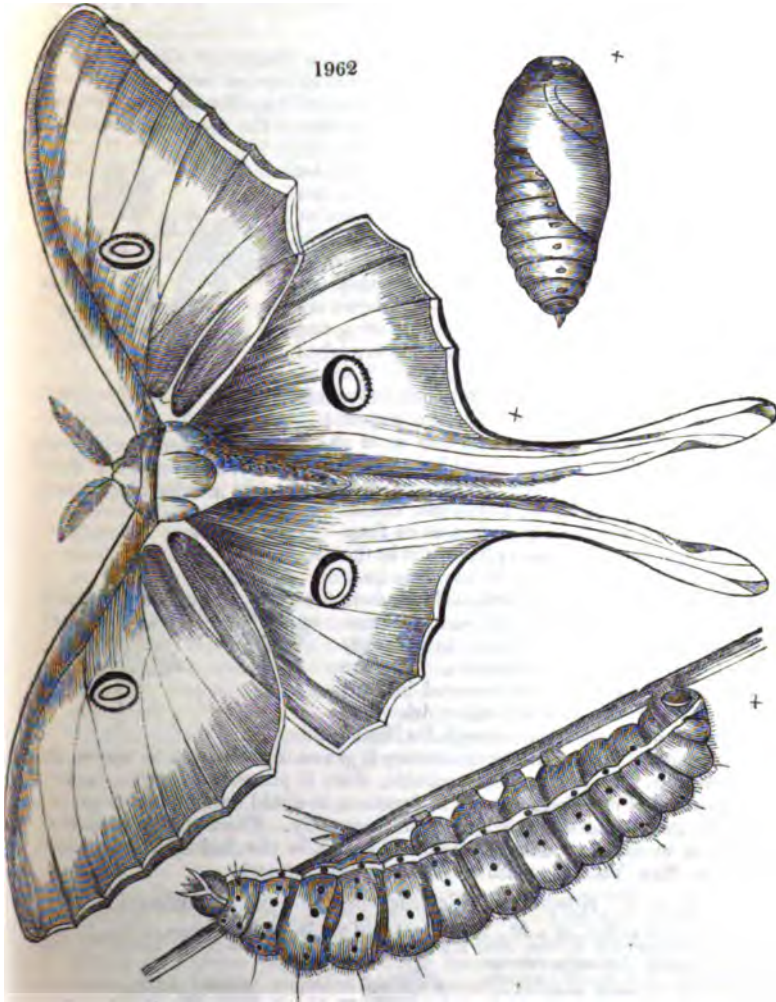

of the trunk 2½ in., and that of the head 4 ft.—In Ireland. In King's County, at Charleville Forest, 8 years planted, it is 9 ft. high, the diameter of the trunk 3 in., and that of the head 9 ft. In Down, at Ballyleady, 26 years planted, it is 15 ft. high, the diameter of the trunk 12 in. In Louth, at Oriel Temple, 40 years planted, it is 22 ft. high, the diameter of the trunk 11½ in., and that of the head 15 ft.—In France, in the Jardin des Plantes, at Paris, 25 years planted, it is 20 ft. high, the diameter of the trunk 1 ft. 6 in.; in the Botanic Garden at Toulon, 50 years old, it is 50 ft. high, the diameter of the trunk 2 ft.; at Avranches, in the Botanic Garden, 29 years planted, it is 50 ft. high, the diameter of the trunk 7 in., and of the head 8 ft.—In Hanover, at Harbke, 8 years planted, it is 10 ft. high.—In Prussia, at Berlin, at Sans Souci, from 45 to 50 years old, it is 18 ft. high, with a trunk 11 in. in diameter.—In Italy, in Lombardy, at Monza, 24 years old, it is 30 ft. high, the diameter of the trunk 1 ft., and of the head 25 ft.

Commercial Statistics. Plants, in the London nurseries, are 1s. 6d. each; and seeds in the cone, or catkin, are 2s. per pint. At Bollwyller, plants are ½ francs and 50 cents each; and at New York they are 25 cents.

‡ 2. *L. IMBE'RBE* Willd. The beardless, or *Oriental*, Liquidambar.
Identification. Willd., *Sp. Pl.*, 4, p. 475.; *Ait. Hort. Kew.*, 3, p. 365.; *N. Du Ham.*, 2, p. 44.
 G R 4

Synonymes. *L. orientalis* Mill. *Dict.*, No. 2.; ? *Platanus orientalis* Pook. *Itin.*, 2 t. 89.; *L. imberbis* Smith in *Rees's Cycl. Engravings.* ? Pook. *Itin.*, 2 t. 89.; and our *fig.* 1963.

Spec. Char., &c. Leaves palmate-lobed, with the sinuses at the base of the veins; smooth. (*Willd.*) This is a low stunted tree, or large bush, of slow growth, with numerous small branches crowded together into an irregular head. The young shoots are pliant and reddish; the leaves are much like those of the preceding species, but smaller, and more like those of the common maple; because they are bluntly notched, while the others are acutely so. See *fig.* 1964., in which *a* is a leaf of *L. Styraciflua*, and *b* one of *L. imberbe*, both to the same scale. The veins of the leaves, in this species, are naked, while in the other they are hairy at the base of the midrib. The flowers are disposed like those in the preceding species, and the fruit is smaller, and more sparingly furnished with prickly points. The rate of growth, in the climate of London, is slow, being not more than 5 ft. or 6 ft. in ten years; and the largest tree that we know of in England, which is in the Mile End Nursery, is only 15 ft. 6 in., though it must have been planted 50 years, and probably more. The tree is a native of the Levant; and was introduced into France, according to Du Hamel, by M. Peyssonel, consul at Smyrna; and from France sent to England, to Miller, who raised plants of it in the Chelsea Garden in 1759. It has since been cultivated in choice collections; but, from its only being raised by layers, and not forming such a handsome tree, not so generally as the Liquidambar *Styraciflua*. We are not aware that it has ever flowered in England. It will grow in a soil rather drier than the preceding species will; though Du Hamel was informed that in its native country it grows in moist soil, by water, like the willow. It is therefore probable, that, if planted in similar soil in England, and in a sheltered warm situation, it would attain a much greater height than it has hitherto done in this country. Price of plants, in England, as in the preceding species. It is not in the Bollwyller catalogue, and at New York the price of plants is 1 dollar each.

1963



1964

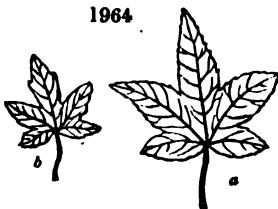

App. i. Species of *Liquidambar* not yet introduced.

L. Altingia Blume *Bjdr.*, 10. p. 527., *Fl. Jav.*, t. 1., and our *fig.* 1965.; *Altingia excelsa* Noronha in *Batav. Verhandl.*, 5. p. 1., *Fers. Syn.*, 2. p. 579., *Spreng. Syst. Veg.*, 3. p. 868., *Lambert's Genus*

Pinna, 1. t. 39, 40.; *Lignum papuanum* *Rumph.*, *Herb. Amb.*, 2. p. 57.; *Alting's Liquidambar.* Leaves ovate-oblong, acuminate, serrated, glabrous. (*Blume.*) A tree, with a spreading head, from 150 ft. to 200 ft. high; the trunk straight and thick, especially towards the bottom, where there are 4 or more deep furrows, seeming as if they had been hollowed out. The bark externally is of a whitish ash colour, even or warty, of a brownish red internally; the juice acrid and somewhat bitter: when wounded, a honey-like sweetish balsam exudes. Branches alternate, round, and warty; young ones furrowed, and smooth. Leaves alternate, petioled, from 3 in. to 5 in. long, scarcely 2 in. broad; leathery. Petioles from 1/2 in. to above 1 in. in length, weak, roundish, having at the base 2 small, subulate, deciduous stipules. Capsules obovate, somewhat 2-lobed. This immense tree can never escape the eye of the traveller in the forests of the west of Java. It is found very plentifully in the provinces of Bantam and Buitenzorg, at an elevation of from 2000 ft. to 3000 ft.; but in the east of Java it is



1965

very rare, if not totally wanting. Noronha first described this tree in the *Act. Soc. Batav.*; but he had not the least suspicion that it belonged to the genus *Liquidambar Linn.* The small grains which are found along with the seeds in some capsules, which are nothing more than abortive ovules, and which had been observed by Linnæus in *L. Styraciflua*, he described as small chaffy bodies, mixed with the membranous tops of the seeds. It is called by the natives of Java, *Ras-sa-ma-la*; by the Arabs, *Rasem-malla*; by the inhabitants of New Guinea, *Russimal*; and by those of Cochin-China, *Rosa-malla*. The wood is at first reddish, and afterwards brownish; very compact, hard, of a beautiful grain, and having a grateful balsamic odour. It is much esteemed by the Javanese for beams and planks. The flowers appear in May and June; and the fruit is ripe in September, and the following months of the same year. (*Blume Fl. Jav.*, t. 1, 2.) Sprengel imagined that this tree was the same as our *Araucaria excelsa*; an error which was detected by the description and figure of Blume, as given above.

CHAP. CIX.

OF THE HARDY AND HALF-HARDY LIGNEOUS PLANTS OF THE ORDER MYRICA'CEÆ.

MYRICA L. Flowers unisexual; those of the two sexes upon different plants. — Male flowers in cylindrical sessile catkins. Each flower consists of 4, rarely more, stamens; these are inserted at the base of a bractea. Bracteas extending beyond the stamens, loosely imbricated. — Female flowers closely disposed into ovate sessile catkins, and attended by closely imbricated bracteas. One bractea attends 2 flowers. Each flower consists of a calyx of 2—4 very minute scales; an ovary, to which the scales adhere; a short style; and 2 long thread-shaped stigmas. Ovary 1-celled, and including one upright ovule. Carpel involucreted by the adherent, more or less fleshy, enlarged calyx, and so more or less resembling a berry. Seed erect, exalbuminous. — Species few; natives of the torrid and frigid zones of both hemispheres. Shrubs. Leaves alternate, persistent, or annual; simple in most, if not all; generally more or less serrated, besprinkled with resinous dots, as are the scales of the buds, and the surface of the fruit; which yield, when rubbed, an aromatic odour. Catkins axillary, expanding early in the following year in the kinds with annual leaves. (*T. Nees ab Esenb. Gen. Pl. Fl. Ger.*; *Smith Eng. Fl.*; and observation.)

COMPTONIA Gærtn. Flowers unisexual; those of both sexes upon one plant, and in catkins. — Male catkins lateral, cylindrical, of several flowers. Bracteas imbricated. Flower of "3-twin" (*Watson*) stamens, seated towards the base of a bractea; sessile. Anthers 2-lobed, opening at the side. — Female catkins lateral, ovate, of several flowers. Bracteas imbricated. Flower of a calyx and pistil. Calyx free, flat, 6-parted; segments slender, unequal in length; the longest as long again as the bractea. Ovary subglobose, depressed. Style short. Stigmas 2. Fruit 1-celled, ovate, hard, shining, attended by the calyx. Seed 1, oval. — Species 1, a bushy dwarfish shrub, wild in sandy, stony, or slaty woods, in North America, from New England to Virginia. Leaves alternate, lanceolate, pinnatifidly toothed, downy, sprinkled with golden, resinous, transparent particles; annual. A fragrant odour resides in the resinous particles upon the leaves, and, it is likely, in other parts of the plant. (*Wats. Dend. Brit.*; *N. Du Ham.*; and observation.)

GENUS I.



MYRICA L. THE CANDLEBERRY MYRTLE. *Lin. Syst. Dicæcia* Tetrándria.

Identification. *Lin. Gen.* 518.; *Juss.* 409.; *Fl. Br.*, 1076.; *Lam.*, t. 809.; *Gærtn.*, t. 39.; *Eng. Fl.*, 4 p. 238.; *N. Du Ham.*, 2 p. 189.

Synonymes. Galé, Fr.; Wachs Strausa, Ger.

Derivation. From *myrō*, to flow; the plants being found on the banks of rivers.

Description, &c. Aromatic shrubs; natives of Europe and North America. They are of low growth, and generally require a moist, peaty soil. In British gardens, the species are propagated by layers, the stools being planted in moist peat soil. As the species throw up abundance of suckers, they may be also propagated by removing them, or by division of the plant. The American species is sometimes propagated by seeds, which should be sown in autumn, as soon after they are received from America as possible; for, if kept out of the ground till spring, they will not come up till the spring following. Plants, in the London nurseries, are from 6d. to 2s. each; at Bollwyller, 1 franc 50 cents; and at New York, 37½ to 50 cents.

■ 1. *M. GALE L.* The Sweet Gale, Sweet Willow, Candleberry Myrtle, or Dutch Myrtle.

Identification. Lin. Sp. Pl., 1453.; Willd. Sp. Pl., 4. p. 745.; Fl. Br., 1076.; Eng. Bot., t. 532.; Hook. Scot., 288.; Fl. Dan., t. 327.; Ehrh. Fl. Off., 339.; N. Du. Ham., 2. p. 194.; Eng. Fl., 4. p. 239.; Hook. Br. Fl., p. 432.; Lindl. Synop., p. 942.; Mackay Fl. Hibern., p. 257.; Lodd. Cat., ed. 1836.

Synonymes. Gale Rall Syn., 443.; Bauh. Hist., 1. p. 2.; *Elmagnus* Coyd. Hist., 212., Lob. Ic., 2. p. 116.; *Myrtus brabantica* Ger. Emac., p. 1414.; *Rhus myrtifolia* Belgica Basa. Pin., 414.; *R. sylvatica* altera DeJuss. Hist., 110.; *R. sylvatica* Paok. Theat., p. 1451.; *Myrica palustris* Lam.; Galé, Fomento royal, Fr.; genuine Wachs Strauch, Ger.

Enumerations. Eng. Bot., t. 532.; Fl. Dan., t. 327.; Hayne, t. 200.; Lob. Ic., 2. p. 116. f.; N. Du. Ham., 2. t. 57.; and our Ag. 1863.

The Series. Both are in the arboretum of Messrs. Loddiges.

Spec. Char., &c. Leaves lanceolate, serrated; tapering and entire at the base. Scales of the catkins pointed. (Smith.) A deciduous aromatic shrub, which rises with many stems, from 2 ft. to 4 ft. high; dividing into several slender branches, which are covered with a ferruginous-coloured bark, sprinkled with white dots. The leaves are alternate, on short footstalks, obovate-lanceolate, tapering and serrated towards the point. They are rigid, smooth on both sides, and of a light or yellowish green, palest on the under side. They are covered with resinous dots, which emit a delightful fragrance when bruised. According to Sir W. J. Hooker, the whole "plant diffuses an agreeable smell:—

"Gale from the bog shall waft Arabian balm."

Bot. Flor., ed. 2., p. 432.



The catkins are numerous and sessile; they are formed in the course of the summer's growth, and remain on during the winter, expanding the following spring, before the leaves. The flower buds are above the leaf buds, at the ends of the branches; whence, as soon as the fructification is completed, the end of the branch dies, the leaf buds which are on the sides shoot out, and the stems become compound. The scales of the male catkins are of a red shining brown; and the lower ones of the female catkins have a cirlet of red hairs towards the tip. The berries are very small, and covered with resinous dots, like the leaves. Though the male and female flowers are generally produced on different plants, they are sometimes found on the same plant; a fact first observed by John Templeton, Esq., of Belfast. (See Smith's *Eng. Flora*, iv. p. 239.) The sweet gale is a native of the north and centre of Europe, of the north of Asia, and of North America, in Pennsylvania and Canada. In Europe, it is found in Lapland, Norway, and Sweden, France, Germany, and the Austrian dominions, as far south as the north of Italy. In Great Britain, it is found from Sutherland and the Grampian Mountains, to Cornwall, as high as 1400 ft. above the level of the sea; being more hardy than the hazel. It is a native of Ireland; and there, as every where else, it is found almost exclusively in bogs and marshes. The gale was noticed by all the older botanists: Ray and Bauhin (in his *Historia*

Plantarum) called it *Gale*; Carduus and L'Obel, *Elæagnus*; and Dalechamp and Parkinson, *Rhûs*; the latter supposing it to be the *Rhûs sylvêstris*, or wild sumach, of Pliny; while the Danish professor, Simon Paulli, asserted it to be the same as the Chinese tea tree. According to Gerard, this plant, in his time, grew so abundantly in the Isle of Ely, that the inhabitants made faggots of it (which they called goule sheaves) to heat their ovens. In more modern times, the twigs are laid by country people among clothes, to give them an agreeable smell, and to keep away the moths. The Welsh lay branches on their beds to keep off the fleas. The plant is also used, both in Wales and Sweden, to dye wool yellow, and to tan calf-skins. The leaves are bitter, and are sometimes used instead of hops in brewing beer; but, unless boiled a long time, they are reported to give a headache. A strong decoction of the leaves and twigs is used, in Sweden, to destroy bugs; and both the Highlanders and the Welsh give an infusion of the leaves to children, to kill worms. In Scotland, the inhabitants stuff beds with the leaves. The berries are put in beer, in the same manner as those of *Cocculus indicus*, to make it heady and intoxicating; and, when dry, they are used, at St. Léger, in the neighbourhood of Paris, as spice. In a fresh state, they yield an essential oil by distillation. Linnæus states that the catkins, when boiled, will throw up a scum like wax. The gale is the badge of the Highland clan Campbell. A variety with larger leaves, &c., is mentioned by Mirbel, and a figure of it given in the *Mém. Mus.*, 14. p. 474. t. 28., of which our fig. 1967. is a reduced copy.



■ 2. *M. CERIFERA* L. The common Wax-bearing, or American, Candleberry Myrtle.

Identification. Willd. *Sp. Pl.*, 4. p. 745.; Pursh *Fl. Amer. Sept.*, 2. p. 260.; N. Du Ham., 2. p. 190.; *Lam. Encyc.*, 2. p. 592.; *Ldn. Sp.*, 1453.; *Reich.*, 4. p. 244.; *Hort. Cliz.*, 455.; *Grøn. Virg.*, 120.; *Kalm It.*, 2. p. 312.
Synonymæ. *M. cerifera angustifolia* *At. Hort. Kew.*, 3. p. 396.; *Myrtus brabantica*, &c., *Pluk. Alm.*, 260. t. 48., *Cat. Car.*, 1. p. 63.; *Cârier de la Louisiane, Fr.*
Engravings. *Fluk. Alm.*, t. 48. f. 9.; *Cat. Car.*, i. t. 63.
The Seeds. Only the male is in the Hackney Arboretum; but, as seeds are annually imported from America, the female is doubtless in the country in many places.

Spec. Char., &c. Leaves lanceolate, pointed, serrated, flat, somewhat shining. (*Lam. Encyc.*) A large shrub, from 5 ft. to 12 ft. high, and upwards; a native of North America. Introduced in 1699, and flowering in May or June.

Varieties.

■ *M. c.* 2 *latifolia* Ait. *Hort. Kew.*, ed. 1., iii. p. 396.; *M. c. média Michx.* *Fl. Bor. Amer.*, ii. p. 228.; *M. carolinensis* Willd. *Sp. Pl.*, iv. p. 746., *Ait. Hort. Kew.*, edit. 2., v. p. 379., *Mill. Dict.*, No. 3., *Pursh Fl. Amer. Sept.*, ii. p. 620.; *M. pennsylvanica* *Lam. Encyc.* ii. p. 592., *N. Du Ham.*, ii. p. 190. t. 55., and our fig. 1968.; *M. c. sempervirens* *Hort.*; *Myrtus brabantica* *Cat. Car.*, i. t. 13.; *Cârier de Pennsylvanie, Fr.*, *Carolinischer Wachstrauch, Ger.* *The broad-leaved American Candleberry Myrtle.*—This variety has the leaves broader than those of the species, and an arborescent stem. According to the *Nouveaux Du Hamel*, it is harder than *M. cerifera*; and, in the garden at Malmaison, near Paris, has attained the height of 8 ft. It is mentioned by Catesby, as having its leaves broader, and more serrated, than the common American candleberry myrtle; and it appears that it was



cultivated in England before 1730, as it is included in the *Hortus Anglicus*, published in that year.

- *M. c. S pumila* Michx. Fl. Amer., ii. p. 228., Pursh Fl. Amer., Sept., ii. p. 620., has the leaves linear-lanceolate. In the *Nouveau Du Hamet*, it is suggested that this is only a variation produced by some difference of climate or soil. It is very low, and its leaves are not larger than those of the sweet gale of Europe.

Description, &c. The American candleberry myrtle is a large evergreen shrub, growing to the height of 12 ft. and upwards, in favourable situations, and forming a thick bush. Its general appearance and habits closely resemble those of the European species; the leaves are, however, larger, and more serrated; they are evergreen, and, in *M. c. latifolia*, greatly resemble those of the sweet bay. The male catkins are axillary and sessile; but have not the shining scales of the *Myrica Gale*. The fruits are globose drupes, about the bigness of a grain of black pepper; covered with an unctuous substance as white as snow, which gives them the appearance of a kind of sugar plum. The candleberry myrtle is found in North America, from Virginia to Carolina; and the varieties, in New England and Pennsylvania: the species, and *M. c. pumila*, often in dry shady woods; while the broad-leaved variety, like the *Myrica Gale* of Europe, delights in wet places about swamps or rivers. A kind of candleberry myrtle is found in Canada; but it appears to belong to *Myrica Gale*, and not to *M. cerifera*. The principal, if not the only, use made of the candleberry myrtle, in America, is the collecting from it of its resinous wax. This substance, according to Duplessy, was formerly procured by gathering the berries carefully with the stalk attached, and boiling them till they burst, when the oily matter they contained rose to the surface; it was then skimmed off, and set aside to harden, till it became a substance of about the consistence of putty, and of a greenish colour, which was easily blanched, and was readily inflammable when made into candles. A better way is said to be, pouring boiling water on the berries, by which means a purer wax is extracted, of a pale yellow colour. The candleberry wax is so brittle, that a piece will break if let fall: it may also be reduced to powder, like common resin. It becomes, however, soft, like common wax, by pressure. When made into candles, it is necessary to mix it with bees' wax, or a little suet. The water in which the berries were boiled or infused is used to give a greater degree of firmness to tallow candles. (*Végétaux Résineux*, ii. p. 60.) Cultivated trees are said to yield more wax than those that are found wild. The candles formed of this wax burn long, and yield a grateful smell (*Smith's Corr. of Linn.*); and they are said to have the advantage of producing an agreeable aromatic fragrance when they are blown out, or otherwise extinguished. According to Kalm, a soap is made from the wax, and it is used by surgeons for plasters. In Carolina, a kind of sealing-wax is made of it; and the root is accounted a specific in the toothach. This shrub has been cultivated in English shrubberies since 1699; and there are plants of it at the Duke of Devonshire's villa at Chiswick, and at various other places in the neighbourhood of London, from 6 ft. to 8 ft. high. In France and Germany, it has been cultivated with a view to its producing wax; and it is said to thrive in sandy peat, rather moist, and to produce an abundant crop of berries every year. In Prussia, it has been cultivated in a garden on the banks of the Spree, near Berlin, in lat. 52° 53'; which is nearly 1½ degree farther north than London; but where the mean annual temperature is 2° 9' higher than London; and wax and candles have been made from the fruit. It has been suggested by Dr. Hamilton (*Gard. Mag.*, vol. i. p. 403.), that it might be cultivated for the same purpose in high sandy wastes in Hampshire, and other parts in the south of England.

App. i. *Half-hardy Species of Myrica, cultivated in British Gardens.*

M. Faya *Al. Hort. Kew.*, ed. 1. 3. p. 397., *N. Du Ham.*, 2. p. 194., *Lodd. Cat.*, ed. 1836, and our *Ag.* 1969.; the *Azores Candleberry Myrtle*; has the leaves elliptic-lanceolate, somewhat serrate. Male catkins compound. Drupes with a 4-celled nucleus. (*Willd. Sp. Pl.*, iv. p. 747.) An evergreen shrub,

a native of Madeira and the Azores. Introduced in 1777, by Mr. Masson, and flowering in June and July. There are plants at Messrs. Loddiges's.

M. serrata Lam. Encyc., 2 p. 593, N. Du Ham., 2 p. 192; *M. mthiōpica* Lin. Syst., 884., Reich. 4 p. 424.; *M. conferta* Burm. Prod., 71., Pluk. Phyt., t. 46. f. 8. Leaves linear-lanceolate, pointed, deeply and somewhat doubly serrated. (Lam. Encyc.) An upright-growing evergreen shrub, about 2 ft. high, with very glabrous leaves, of a beautiful green; the old ones somewhat drooping. The name alludes to the serratures of the leaves, which are very deep and open. The berries resemble those of *M. cerifera*; but they are black when quite ripe, and preserve a point at the summit. A native of the Cape of Good Hope. Introduced by Mr. F. Masson, in 1793.

M. oerrefōlis Lin. Sp. Pl., 1453., Reich., 4 p. 424., Burm. Fl. Ind., t. 98. f. 1., Hort. Cliff., 466., Pluk. Alm., t. 424., N. Du Ham., 2 p. 193., Lam. Encyc., 2 p. 593., Lodd. Cat., ed. 1836; *Laurus africana*, &c., Com. Hort., 2 t. 81., Basil Supp. Dend., 85.; has the leaves ovate-wedge-shaped, sinuate, serrated, bluntish; the divisions often angular. (Lam. Encyc.) A shrub, 2 ft. or 3 ft. high, with numerous reddish and slightly tomentose branches. The leaves are quite smooth, and dotted. A native of the Cape; flowering in June and July. Introduced before 1752, as it was cultivated in that year by Miller.

M. c. serrata Mill. Dict., Ait. Hort. Kew., edit. 2., v. p. 380., only differs from the preceding in having the leaves hairy.

M. cordifolia Lin. Sp., 1454., Reich., 4 p. 245., Hort. Cliff., 456., Pluk. Phyt., t. 319. f. 7., N. Du Ham., 2 p. 193., Roy Lugdb., 527; *Alaternoides Flicis folio*, &c., Wall. Hort., 3 t. 3.; *M. foliis subcordatis*, &c., Burm. Afr., t. 98. f. 3.; *Gale capensis*, &c., Petit. Mus., 774.; *Coriogrammatodendros Flicis aculeatis folio* Pluk. Alm., 65., Pluk. Phyt., t. 319. f. 7.; *M. capensis* Lodd. Cat., 1836; has the leaves somewhat cordate, serrate, sessile. (Lin.) An upright-growing evergreen shrub, with wand-like branches; downy and reddish when young, and much leaved; according to the *Nonnessus Du Hamet*, the most ornamental species of the genus. The leaves are numerous, small, heart-shaped, and dentated. It flowers in May and June. The berries are rather larger than those of *M. cerifera*. A native of the Cape, cultivated 1759, by Miller. Thunberg, in his *Travels*, says: "The branches of the wax shrub (*Myrica cordifolia*), the berries of which are covered with a fat substance, resembling bees' wax, were put whole into a pot of boiling water, in order to melt and skim off the wax. It resembles grey impure wax, is harder than tallow, and somewhat softer than wax. The farmers use it for candles; and the Hottentots eat it like a piece of bread, with or without meat." (Thunberg's *Travels*, l. p. 157.) We have little doubt that this species would thrive against a conservative wall.



App. ii. *Half-hardy Species of Myrica not yet introduced.*

M. spatulata Mitr. Mém. Mus., 14. p. 474. t. 22. f. 1.; and our *Ag.* 1970. Leaves spatulate, blunt, quite entire, glabrous. Male catkins sessile, axillary, solitary, shorter than the petioles. A tree, with smooth, cylindrical branches. Leaves 1 in. to 2½ in. long, and ¼ in. to 1 in. broad. Found in Madagascar by M. Pérodet.

GENUS II.



COMPTONIA Banks. THE COMPTONIA. Lin. Syst. Monœcia Triandra.

Identification. Gært. Fruct., 1 p. 58.; N. Du Ham., 2 p. 45.

Synonymes. Liquidambar Lin. Sp.; Myrica Lin. Hort. Cliff., 456., Gron. Virg., 2 p. 155.; Gale Petit. Mus., 773.; Comptone, Fr.; Comptonie, Ger.

Derivation. Named in honour of Henry Compton, Bishop of London, the introducer and cultivator of many curious exotic plants, and one of the greatest patrons of botany and gardening of his time.

Description, &c. A low evergreen shrub, a native of North America, in moist peaty soils, nearly allied to *Myrica*. Only one species has hitherto been described.

1. C. ASPLENIFOLIA Banks. The Asplenium-leaved Comptonia.

Identification. Ait. Hort. Kew., 3 p. 334.; Gært. Fruct., 1 p. 58.; L'Hérit. Stirp., nov. ed., 2 t. 58.; N. Du Ham., 2 p. 46.; Dend. Brit., t. 166.; Pursh Fl. Amer. Sept., 2 p. 635.; Lodd. Cat., ed. 1836.

Synonymes. Liquidambar asplenifolium Lin. Sp., 1418., Du Ham. Arb., 1 p. 366.; L. peregrinum Lin. Syst., 860., Reich., 4 p. 171.; Myrica Lin. Hort. Cliff., 456., Gron. Virg., 155., Cold. Novob., 224., Mûl. Dict., No. 4.; Gale mariana Pet. Mus., 773.; Myrtus brabantica affinis Pluk. Phyt., t. 100. f. 6, 7.; The sweet Fern Bush, Amer.

Engravings. Pluk. Phyt., t. 100. f. 6, 7.; N. Du Ham., t. 11.; Dend. Brit., t. 166.; and our *Ag.* 1971.

Spec. Char., &c. Leaves long, linear, alternate, crenately pinnatifid. (Willd. Sp. Pl., iv. p. 320.) A deciduous shrub, 3 ft. or 4 ft. high. The young

branches are downy. Leaves alternate, oblong, linear; cut on each side into rounded and numerous lobes, like those of the ceterach; and sprinkled with shining dots, like those of the gales. The male catkins are oblong and sessile; female catkins sessile, solitary, lateral, and bristly, with numerous filaments. According to Pursh, the whole plant, when rubbed, has a resinous scent. A native of North America, from New England to Virginia, in sandy, stony, or slaty woods. It was introduced in 1714, by the Duchess of Beaufort. The shrub is very hardy, but it requires peat earth and a shady situation. It may be propagated by layers, suckers, or seeds. The first and second methods are the most common, as good seeds can rarely be procured. Plants, in the London nurseries, are from 1*s.* to 1*s.* 6*d.* each; at Bollwyler, 3 francs; and at New York, 37½ cents.



CHAP. CX.

OF THE HALF-HARDY LIGNEOUS PLANTS OF THE ORDER CASUARACEÆ.

THIS remarkable family consists of branchy trees, the branches of which are in all cases, when fully grown, "long, drooping, green, and wiry, with very small scale-like sheaths, in the room of leaves. The flowers are unisexual, and disposed in verticillate spikes; they have neither calyx nor corolla, are monandrous, and their ovaries are lenticular, with a solitary erect ovule. The fruit consists of hardened bracts, enclosing the small caryopes, or nut-like seeds, which are winged." (*Lindl.* in *Penny Cyc.*) Natives of Asia, Australia, and Polynesia. This order was formerly considered to belong to Coniferae; but is now placed by botanists next to Myricaceæ. The timber of some of the species forms the beef-wood of the New South Wales colonists, and is of excellent quality. In British gardens, the plants are more hardy than most of the Australian trees; and, in warm situations in Devonshire, or sheltered by evergreens in other parts of the south of England, would probably attain a timber-like size without any care or trouble whatever.

Casuarina equisetifolia Ait. Hort. Kew., iii. p. 320., Willd. Sp. Pl., iv. p. 190., Bot. Cab., t. 607., and our fig. 1972.; *C. littorea* Rumph. Amb., iii. t. 57.; Swamp Oak, Austral.; Filso à Feuilles de Prêle, Fr. Monoecious. Branchlets weak, round. Scales of the strobiles unarmed, villous; sheaths of the male 7-parted, ciliated. A lofty tree, with a large trunk, and numerous branches. These branches are long, slender, wand-like, cylindrical, weak, and drooping, bearing a great resemblance to those of the common horsetail. Six or seven scales, or teeth, on each branch, serve instead of leaves. The catkins are upright and terminal; the scales of the cones are downy; and those of the male catkins are ciliated. In Australia, it flowers in October and November. It is a native of the East Indies, New Holland, and the South Sea Islands; from which last country it was introduced in 1766, by Admiral Byron. From the cone-like shape of its fruit, it was at first supposed to belong to the Coniferae, and was called the Tinian pine. It stands out in the climate of London; and there is a tree in the garden of Wm. Bromley, Esq., 11 ft. high, of which our fig. 1972. is a portrait, taken in 1834. In the *Transactions of the Horticultural Society* for 1818 is an account, accompanied by a figure of the entire tree, of a species of *Casuarina* then growing in the gardens of Belvedere, near Weimar, communicated by His Royal Highness Charles Augus-

tus Grand-Duke of Saxe-Weimar. The species of *Casuarina* here alluded to was sent to Weimar originally under the name of *Casuarina equisetifolia* Linn.; and was, in the year 1810, but a very small shrub, not more than 3 ft. high, and the trunk three fourths of an inch in diameter. In that year, it was planted in the open air, in good soil, containing a portion of calcareous matter, the substratum of the country being of that nature. It was so placed as to receive the full influence of the sun in summer, and to be protected from the northern and eastern winds. In the winter, it was covered with a temporary building, which was warmed by fire, so as to exclude the frost.



The height of the tree, in 1818, was 16 ft. 6 in., the circumference of the head 42 ft., and that of the trunk nearly 20 in. Near to this tree was another, which was planted in 1813. It was sent from Paris to Weimar in a flower-pot, and was then a very small shrub. In 1818, it had already reached the height of 8 ft., and the trunk was nearly 2 in. in diameter. The larger tree flowered in 1818, but without producing any seed, being evidently a dioecious plant. With regard to the botanical character of this *casuarina* some doubts have arisen. It does not seem to be the species usually called *equisetifolia*. The Belvedere plant appeared, in 1818, to be clearly dioecious: it was covered with male flowers, and not a single female was to be seen. Whether this arose from the circumstance that, in monoecious plants, one set of flowers sometimes so strongly predominates as to render the other imperceptible, and that a sort of equality between the two sets of flowers only takes place as the plant advances in age; or that the plant in question was not *C. equisetifolia*, but another species of the genus, which is dioecious; is uncertain.

C. nodiflora Forst. Prod., No. 335., Willd. Sp. Pl., 4. p. 190. Monoecious. Branchlets erect, tetragonal. Scales of the strobiles unarmed, glabrous. Sheaths of the male 4-cleft, glabrous. A tree, 15 ft. high; a native of New Caledonia. Introduced in 1823.

C. distyla Vent. Cels., t. 62., Willd. Sp. Pl., 4. p. 191. Dioecious. Branchlets erect, round. Scales of the strobiles unarmed, ciliated. Sheaths of the male 7-cleft, somewhat ciliated. Flowers 2-styled. A tree, 15 ft. high; a native of New Holland. Introduced in 1818.

C. stricta Ait. Hort. Kew., 3. p. 320., Willd. Sp. Pl., 4. p. 190., Bot. Rep., t. 346. Dioecious. Branchlets erect, furrowed. Scales of the strobiles unarmed, smoothish. Sheaths of the male multifold, glabrous. A tree, a native of New Holland. Introduced in 1775, by Messrs. Kennedy and Lee. It flowers in November and December. There is a plant in the Horticultural Society's Garden, which has stood against a conservative wall since 1830; and there are plants at Messrs. Loddiges's.

C. torulosa Ait. Hort. Kew., 3. p. 320., Willd. Sp. Pl., 4. p. 191. The cork-barked *Casuarina*. Dioecious. Branchlets weak. Scales of the strobiles villous, tuberculate, rough. Sheaths of the male 4-cleft. A large tree, a native of Holland. Introduced in 1772, by Sir Joseph Banks. There are plants at Messrs. Loddiges's.

Culture, &c. As all the above species are probably equally hardy, we would recommend as many of them as possible to be got, and planted in warm situations, in dry, sandy, pine or fir woods, where they would be thoroughly sheltered. The pines should be at least 6 ft. or 8 ft. higher than the *casuarinas*; but their branches should never be allowed to come nearer them than within 2 ft. or 3 ft.; and the roots of the pine trees, on the side next the *casuarina*, should be cut off annually with a spade. As the *casuarina* in-

creases in size, the pines or firs surrounding it should have their branches cut in, or the trees should be cut down, so as to allow the former room to expand on every side, and to increase its power of resisting cold and wind, as it increases in size. Ultimately, a space of such dimensions might be left round it as to admit of a spectator looking at the top of the tree, at an angle of vision of from 30° to 35° . We mention this angle of vision, because experience proves that no tree or other object can be seen to the greatest advantage when the angle of vision is either much greater, or much less, than from 30° to 35° . The casuarinas, when grown in pots, thrive well in equal parts of sand, loam, and peat: but, in the open ground, a sandy loam, with a dry subsoil, would probably suit them best; because, in such a soil, they would probably not make more wood than they could ripen before winter. They are all propagated by seeds, but would probably succeed by cuttings of the points of the shoots, in sand, under a bell-glass.

CHAP. CXI.

OF THE HARDY LIGNEOUS PLANTS OF THE ORDER *GNETACEÆ*.

E'PHEDRA Tourn. Devoid of obvious leaves. Leaves scale-like, opposite, in pairs; the direction of the pairs decussating. Flowers unisexual; those of the two sexes upon distinct plants.—Male. Flowers in axillary groups. Flowers in the group opposite, in pairs; the pairs decussate in direction; each pair subtended by a perfoliate bractea. Calyx tubular, bifid in the upper part; first including, then surrounding, a straight column situated at its base, extended beyond its tip, and there divided into 2—8 short pedicels, proper to as many anthers: each anther has two cells, and each cell opens by a terminal hole. — Female. Flowers borne about the terminal parts of a branch, or of branches; in pairs. the pairs 1—2 together, at the tips of axillary peduncles; or 3 together at the tip of a branch. Each flower consists of an ovule, plano-convex, upright, perfoliated at the tip, and terminated by a style-like hollow process, formed from the secundine of the nucleus. The ovules are disposed 2 together, with their flat faces approximate; and the 2 are bracteated by perfoliate decussate bracteas. Each ovule, if not abortive, becomes a seed. The seeds are partly invested with the uppermost and upper of the bracteas, enlarged, and rendered fleshy. Embryo in the centre of fleshy albumen. Radicle uppermost. — Species few, natives of the temperate parts of Europe, Asia, and Africa. Shrubs; much branched. Stem and branches jointed, and separable at the joints. (*T. Nees ab Esenb. Gen. Pl. Fl. Ger.; Lindl. Nat. Syst. Bot.; and observation.*)

GENUS I.



E'PHEDRA L. THE EPHEDRA. *Lin. Syst. Dice'cia Monadelphica.*

Identification. *Lin. Gen.*, 1136; *Reich.*, 1942; *Schreb.*, 1524; *Tourn.*, 467.; *N. Du Ham.*, 8. p. 17.

Derivation. From *ephedra*, the Greek name for the *Hippuris*, or Horsetail, which it resembles.

Description, &c. Low shrubs; evergreen, from the colour of the bark of their branches, and in that respect resembling the genera *Casuarina* and *Equisetum*. They are natives of the south of Europe, Barbary, and Siberia, on the sea shore, or in saline or sandy wastes; and they have been but little subjected to cultivation. They might, however, be used in ornamental scenery as evergreens, and even cultivated for their fruit; which, in their native coun-

tries, ripens in spring, becoming succulent, like a little mulberry, with a slightly acid, and yet sugary and agreeable, taste. In the warmer parts of the south of England, this fruit might be cultivated so as to become valuable for the dessert; from its ripening at a time when no other fruit in the open air in Britain is ever found ripe. The plants, when allowed to grow to their full size, form evergreen bushes; not by the colour of their leaves, which are scarcely perceptible, except when very closely observed; but by the deep green bark of the shoots, which, in old plants, are very numerous, and form a dense head. According to Du Hamel, they bear the shears well, and form beautiful round balls, which may either be made to appear as if lying on the ground, or may be trained on a short stem. The lower sorts, Du Hamel continues, may be clipped to resemble turf; and for that purpose the plant may be valuable, in some parts of Australia and Africa, to form lawns which shall create an allusion to temperate climates. The saving by using such plants as *E'phedra*, which would require little or no watering, instead of a great deal, as the European grasses would do in such a climate, would be very considerable.

1. *E. DISTA'CHYA* L. The two-spiked Ephedra, *Great shrubby Horsetail*, or *Sea Grape*.

Identification. Lin. Sp. 1472; N. Du Ham., 3. p. 19; Ait. Hort. Kew., ed. 1., 3. p. 16.

Synonyma. *E'phedra vulgaria* Rich. *Mém. Confif.*, p. 26. t. 4. f. 1.; *Polygonum maritimum* Tabern. Ic., 836; *P. quartum* Plani/ Clus. Hist., 92, Icon., t. 836; *P. lamifolium*, &c., *Bauh. Pin.*, 15; *E'phedra maritima major* Tabern. Inst., 663, *Schedæ Sp.*, No. 214, N. Du Ham., t. 1. p. 220; *Trigos Cam. Hort.*, t. 46; *Raisin de Mer*, *Ephèdre multiflore*, Fr.; *Zweyähriger Ross Schwanz* Ger. *The Seesra*. Both are figured in *Tabernemontanus*, in *Clusius*, and in *Richard*.

Engravings. Tabern. Ic. 836; Clus. Icon., l. 836; Camer. Hort., t. 46; Schkuhr Hand., 3. t. 339; Du Ham. t. 1. pl. 92; Rich. *Mém. Confif.*, t. 4. f. 1.; and our *Agg.* 1973 and 1974.



1973

Spec. Char., &c. Peduncles opposite. Catkins twin. (*Lin.*) A small evergreen shrub, with numerous cylindrical wand-like branches, articulated, and furnished at each articulation with two small linear leaves.

A native of the south of France and Spain, in sandy soils on the sea shore, where it grows to the height of 3 ft. or 4 ft.; and flowers in June and July, ripening its berries a short time afterwards. It was cultivated in England before 1570, by Matthias L'Obel; but, as far as we have observed, justice has never been done to this, or any other species of *E'phedra* in British gardens. There are plants in the Hammersmith Nursery, in the Twickenham Botanic Garden, in the Horticultural Society's Garden, at Kew, and at Messrs. Loddiges.



1974

2. *E. MONOSTA'CHYA* L. The one-spiked Ephedra, or *Small shrubby Horsetail*.

Identification. Lin. Sp., 1472; Ait. Hort. Kew., 3. p. 116; N. Du Ham., 3. p. 18.

Synonymes. *E. petiolis* an'ye phiribus, *Ac.*, *Gmel. Sib.*, l. p. 171.; *E. minima*, *Ac.*, *Ann. Ruth.*, 354.; *E. polygonoides* *Pall. Ross.*; *Ephedre minore*, *Ephedre de Sibirie*, *Fr.*
The Sizes. There are male plants at Messrs. Loddiges's.
Engraving. *Gmel. Sib.*, l. p. 171. f. 1.; *Anna. Ruth.*, t. 26.; *Dend. Brit.*, t. 149.; and our figs. 1975. and 1976., of the male plant.

Spec. Char., &c. Peduncles many. Catkins solitary. (*Lin.*)

This shrub is much smaller, and hardier, than *E. distachys*. It is a native of Siberia, near salt springs, and in saline wastes; and, according to Pallas, is "common in the southern parts of Russia, from the Don and the Volga to the Leira. It is also found in Persia and India. It occurs very plentifully near the Irtyz, sometimes covering large spaces, and having beautifully coloured berries. The Kergisi use the ashes of the wood for snuff." (*Pall. Fl. Ross.*) The plant was introduced into Britain by Messrs. Kennedy and Lee, in 1772.



1975

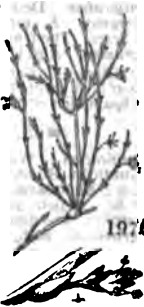

1976

■ 3. *E. ALTISSIMA* *Desf.* The loftiest Ephedra.

Identification. *Desf. Fl. Alt.*, 2 p. 371. t. 253.; *N. Du. Ham.*, 3 p. 18.; *Rich. Mém. Conf.*, p. 29. t. 4. f. 8.

Synonymes. *Ephedra* sive *Anabasis* *Belloni, Ac. Temm. Ins.*, 663., *Vahl. Herb.*, *Hall. Stirp. Hele.*, *Du Ham. Arb.*, t. 1. p. 290.; *Polygonum maritimum scandens* *Bauh. Pin.*, 15.



1977

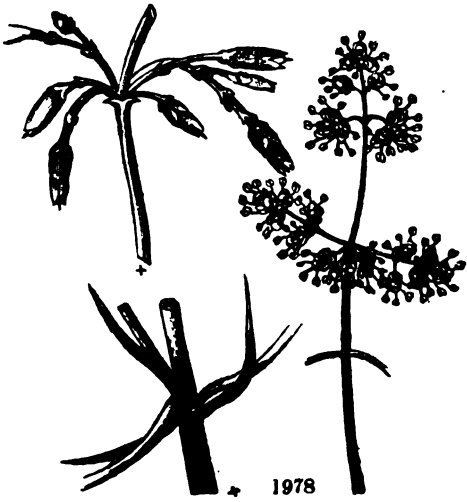

1978

The Sizes. The male is figured in the *Nouveau Du Hamel*, and both sexes in *Richard*.

Engraving. *N. Du Ham.*, t. 6.; *Desf. Fl. Alt.*, 2 t. 263.; *Rich. Mém. Conf.*, t. 4. f. 2.; and our fig. 1977. of the male, from the *N. Du Ham.*; and figs. 1978 and 1979., showing both sexes, from *Richard*.

Spec. Char., &c. Shrubby. Branchlets divaricate, numerous, climbing. Female catkins on foot-stalks, solitary. (*Desf.*) A woody shrub, growing to the height of 15 ft. or 20 ft.; a native of Barbary, where it was discovered by Desfontaines, and introduced by him into France in 1780. It flowers there in winter, and ripens its fruit in spring. Desfontaines describes it as climbing up among other shrubs and low trees; as enduring the winters of France when sheltered a little from the north winds; and as having a most singular aspect, which, he thinks, might be turned to very good account in the *Jardins Anglais*. Plants might surely be procured from the Paris Garden, and tried first against a conservative wall, and next among deciduous shrubs. It is said to have been introduced in 1825; but we have never seen a plant.

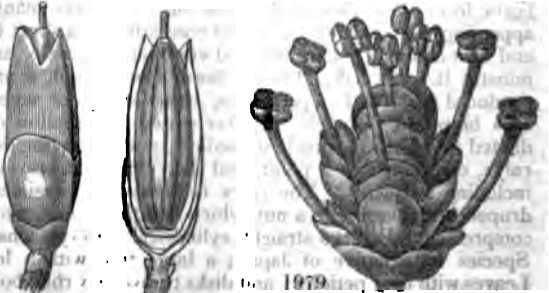

1979

4. *E. FRAGILIS* Desf. The fragile Ephedra.

Identification. Desf. Fl. Alt., 2, p. 372; N. Du Ham., 3, p. 19.
Synonymes. *E. crética* Torr. Cor., 58, *Faill. Her.*; *Equisetum montanum créticum* Alp. Ex. 141.
The Sexes. The female is figured in Alp. Exot., t. 141.
Engraving. Alp. Exot., 141.
Spec. Char., &c. Catkins sessile; the male ones aggregate. Articulations of the branches separable. (*Desf.*) A shrub, between 2 ft. and 3 ft. high, with cylindrical branches, slightly striated; a native of Spain, and of the sea coast of the south of France, but not yet introduced into Britain.

5. *E. AMERICANA* Willd. The American Ephedra.

Identification. Willd. Sp. Pl., 4, p. 860; Kunth in Humb. et Bonpl. Nov. Gen. 2, p. 2; Rich. Mém. Conf., p. 21.
The Sexes. Both are on the same plant, as described and figured by Richard.
Engraving. Rich. Mém. Conf., t. 29, f. 2; and our fig. 1980.

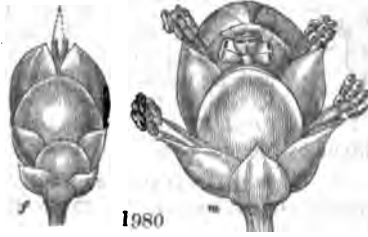

Spec. Char. Stems erect. Branches and branchlets crowded, erect, round, slender. Leaves consisting of a sheath, or 2 semi-oval acuminate scales, spreading or relaxed, and in the fertile branches somewhat distinct; in the sterile ones adhering, so as to form a short tube. Flowers monocious: male and female on the same branchlets, but from different joints; those of the male inferior and fewer in number; heads of flowers crowded round one joint, aggregate, subsessile, on short stalks. (*Rich.*) Found by Humboldt and Bonpland in Quito, at an elevation of almost 7000 ft.; flowering in January. Not yet introduced, though probably quite hardy.

CHAP. CXII.

OF THE HARDY LIGNEOUS PLANTS OF THE ORDER TAXACEÆ.

TAXUS Tournef. Flowers unisexual, axillary; those of the two sexes upon distinct plants. — Male flower. It consists of anthers upon short pedicels, at the top of a column that has imbricate scales at the base: these had enveloped the column and anthers before they were protracted. The anther consists of 4, 5, 6, or rarely more, 1-celled lobes, attached to a connectivum, whose tip is a horizontal shield, lobed at the edge; its lobes corresponding in number and place with those of the anther, and covering them: the cells open longitudinally. — Female flower. An erect ovule, perforate at the tip; and an unobvious annular disk at its base; and, exterior to this, there are investing imbricate scales. — Fruit. The disk, at the base of the ovule, becomes a fleshy open cup, that surrounds the lower part of the seed, which is exposed in the remaining part; the scales are at the base of the cup, outside: the seed is like a nut. — Leaves evergreen, linear-acute, rigid, more or less 2-rowed in direction. (*Nees ab Esenb.*; and *J. D.*'s observation.)

SALISBURYA Smith. Flowers unisexual; those of the two sexes upon distinct plants. — Male. Flowers in tapering, decurved, bractless catkins, which are borne several from one bud; and situated outwardly to a tuft of leaves borne from the centre of the same bud. Flowers many in a catkin, each appearing as a stamen only, and consisting of a short filament-like stalk; and two cases of pollen attached very near to its tip, and a scale that terminates it. — Female. Flowers borne from a bud, from which leaves are produced also; and on peduncles, either singly, or several on the pedicels of a branched peduncle. Flower seated in a shallow cup, formed of the dilated tip of the peduncle or pedicel, and consisting of a rather globose calyx, contracted to a point, and then expanded into a narrow limb, and including an ovary. The calyx is fleshy and persistent, and becomes a drupaceous covering to a nut, which is rather egg-shaped, and very slightly compressed. Embryo straight, cylindrical. Cotyledons two, very long. — Species 1; a native of Japan; a large tree, with a lofty straight stem. Leaves with long petioles; and disks transversely rhomboidal, divided part of the way down into 2 or more lobes; and coriaceous and striated; in groups, or alternately. (*Richard, Smith, Watson, Jacquin, and observation.*)

GENUS I.

TA'XUS L. THE YEW. *Lin. Syst. Dice'cia Monadélphia.*

Identification. Lin. Gen., 532; Juss., 412; Fl. Br., 1086; Tourn., t. 362; Lam., t. 829; Gartn. t. 81.; N. Du Ham., 1. p. 61.; Rich. Mém. Conif., p. 151. t. 2.

Derivation. From *toxos*, a bow; being formerly much used in making them: or from *taxis*, arrangement; from the leaves being arranged on the branches like the teeth of a comb: or from *toxicum*, poison; though Pliny says that poison (*toxicum*) was so named from this tree, which was considered poisonous. The derivation of the term Yew is supposed to be from the Celtic word *hu*, sometimes pronounced *if*, and signifying verdure; alluding to the yew being an evergreen; and this will also explain the French name, *if*.

Description, &c. Evergreen low trees, with numerous, mostly linear, and entire leaves; natives of Europe and North America.

♀ 1. *T. BACCA'TA L.* The berried, or common, Yew

Identification. Lin. Sp. Pl., 1472; Willd. Sp., 4. p. 856; Fl. Br., 1086; Eng. Bot., t. 746; Hook. Scot., 290.; Lightf., 635; Fl. Dan., t. 1940; Bull. Fr., t. 136; Dicks. H. Sicc. Fasc., 16. 6.; Ehrh. Arb., 50.; N. Du Ham., 1. p. 62.; Eng. Fl., 4. p. 252.; Hook. Br. Fl., p. 434.; Mackay Fl. Hibern. p. 259.; Lindl. Synop., p. 241.

Synonymes. *Taxus*, No. 1603., *Hall. Hist.*, 2. p. 322., *Rati Syn.*, 445., *Ger. Em.*, 1570., *Bosch. Hist.*, 1. p. 241., *Math. Valgr.*, 2. p. 444., *Cam. Epit.*, 840.; *lf. Fr.*; *Ihenbaum*, *Ihenbaum*, or *Eihenbaum*, *Ger.*; *Taxo*, *Ital.*; *Taxo Spas.*

The Sexes. The yew being almost always raised from seed, the male and female plants may be supposed to be nearly equally distributed, both in natural woods and in artificial plantations. According to Miller and Lamarck, both sexes are sometimes found on the same tree; and the fact will be found confirmed in a future page. As far as we have been able to observe, says White of Seaborn, the male tree becomes much larger than the female one. (*Nat. Hist. of Selb.*, ed. 1783.)

Enggravings. Eng. Bot., t. 746.; Fl. Dan., t. 1940.; Bull. Fr., t. 136.; Ger. Emac., 1570. f.; Bauh. Hist., 1. p. 241. f.; Matth. Valgr., 2. p. 444. f.; Cam. Epit., p. 840. f.; N. Du Ham., 1. t. 19.; Blackw., t. 572.; Du Ham. Arb., 2. t. 86.; Oelhaf. Abbild., t. 23, 24.; Gartn. Fruct., t. 91. f. 6.; and the plates of this tree in our last Volume.

Spec. Char., &c. Leaves 2-ranked, crowded, linear, flat. Receptacle of the barren flowers globular. (*Smith Eng. Fl.*) A tree, indigenous to most parts of Europe; flowering in March and April, and ripening its fruit in September.

Varieties.♀ 2. *T. b. 2 fastigiata*; *T. fastigiata Lindl.*; *T. hibernica Hook., Lodd. Cat.,*

ed. 1836; our fig. 1981. of the natural size, and the plate of this tree in our last Volume. The upright, or Florence Court, Yew; the Irish Yew. — This is a very distinct variety, readily distinguished from the species by its upright mode of growth, and deep green leaves, which are not in ranks like those of the common yew, but scattered, as shown in fig. 1981. All the plants of this variety in cultivation are of the female sex; and the fruit is oblong, and not roundish, as in the common variety. The finest specimens, Mr. Mackay informs us (*Fl. Hibern.*, p. 260.), grow at Comber, in the county of Down, and near the town of Antrim; where they are supposed to have been planted before 1780. This variety was first observed at Florence Court, near which, on the mountains of Fermanagh, our correspondent Mr. Young informs us, the original tree still exists in a healthy and vigorous state. Fig. 1982., to a scale of 1 in. to 12 ft., is a portrait of one of the trees at Comber, which grows in



the shrubbery of James Andrews, Esq., from a drawing by W. G. Johnson, Esq., of Fortfield, near Belfast, kindly procured for us by Mr. Mackay. The drawing was accompanied by the following description, by Mr. C. J. Andrews, the son of the proprietor of the tree:

—This yew is 21 ft. high; the diameter of the head is 16 ft. 6 in., and the circumference of the trunk, at 1 ft. from the ground, is 4 ft. 5 in.

“The tree resembles an inverted cone formed of numerous richly foliated tapering branches, of a deep green, and studded, in autumn, with scarlet coral-coloured berries. The head of the tree is formed by numerous branches springing up from a main stem of only 1 ft. 6 in. high. These branches vary much in thickness and height; about ten of the largest



having the diameter of a foot each. Their form and growth are, however, very uniform, being richly encircled with innumerable small plume-like shoots, growing vertically along the main branches, of about 6 in. in length, and thickly clothed with narrow decussated leaves of about 1 in. in length; and all so feathering the several arms, as to form the lengthened plumes exhibited by the drawing; about fifty of which easily waved sombre plumes form the top of the tree. The exact age of this yew is unknown: it was planted by John Andrews, Esq., father of its present owner; and it has been certainly 50 years in its present situation. This kind of yew is now very generally and extensively planted here in ornamental plantations; and I can trace much of its propagation, even in Dublin, to the trees sent thither as presents by my grandfather. — *C. J. A., Dublin, Nov. 1836.* There are two trees of this variety at Nether Place, near Mauchline, Ayrshire, respecting which the following information has been transmitted to us by Mr. John Davidson, gardener, at Nether Place. “In compliance with your request I have again measured the Irish yews in Mr. Campbell’s garden at Nether Place. I cannot ascertain the age of the trees, but I am informed by Miss Campbell, that, about 40 or 50 years ago, they failed at their tops, and were then cut over, which, indeed, appears evident on examining the trunks. There are now 66 upright branches from the one trunk, and 56 upright branches from the other, each measuring from 6 in. to 2 ft. in circumference. In appearance the two trees are exactly alike: the larger is 22 ft. 6 in., and the smaller 20 ft. 8 in. in height; the circumference of the larger head is 66 ft. 9 in., and of the smaller 66 ft. 3 in.; the circumference of the larger trunk is 9 ft., and of the smaller 8 ft.; and the trunk of each tree rises about 2 ft. from the soil before it begins to throw out branches. Both trees are in perfect health. These yews must be of slow growth; since, 10 years ago, I propagated some plants from the old trees, and the greatest progress they have made in that space of time is 5 ft. 6 in. in height.” A beautiful drawing of one of these trees, was sent to us by Mr. Davidson, but it came too late to be engraved. One at Balcarras, in Fifeshire, was, in 1834, 15 ft. high. This variety is readily propagated by cuttings put in in autumn in sand, and covered with a hand-glass. It well deserves culture, more especially in small gardens.

■ *T. b. 3 procumbens*; *T. procumbens* Lodd. *Cat.*, ed. 1836; is a low and somewhat trailing shrub, not very common in collections. It is

propagated by layers; and there are plants of it at Messrs. Loddiges's. It appears to be nothing more than a stunted variety of the common yew, and to be identical with the *T. canadensis* of Willdenow, and the *T. b. minor* of the elder Michaux; but, as we have only seen small plants of it and of *T. canadensis*, we have thought it worth while to keep the latter separate for the present.

- *T. b. 4 erecta*, the upright yew, is a seedling from *T. b. fastigiata*, in which the leaves are 2-ranked as in the common yew, but the branches take an upright direction as in the Irish yew. There is a plant in the Horticultural Society's Garden.
- *T. b. 5 foliis variegatis* Lodd. Cat., ed. 1836, has the leaves variegated with whitish yellow. It is seldom found higher than a large shrub. It is propagated by layers or cuttings, either of the ripened wood put in in autumn, or of the newly formed wood put in in July, and treated like the cuttings of Cape heaths.
- *T. b. 6 fructo luteo*. This variety appears to have been first discovered by Mr. Whitlaw of Dublin, about 1817, or before, growing on the demesne of the Bishop of Kildare, near Glasnevin; but it appears to have been neglected till 1833, when Miss Blackwood discovered a tree of it in Clontarf churchyard, near Dublin. Mr. Mackay, on looking for this tree in 1837, found no tree in the churchyard, but several in the grounds of Clontarf Castle; and one, a large one, with its branches overhanging the churchyard wall, from which he sent us specimens. The tree does not differ, either in its shape or foliage, from the common yew; but, when covered with its berries, it forms a very beautiful object, especially when contrasted with yew trees covered with berries of the usual coral colour.

Other Varieties may be selected from beds of seedlings; and it appears that a kind with shorter and broader leaves than usual was formerly propagated in the nurseries. The yew tree, in some situations, is found with spreading branches, not unlike those of a very old spruce fir, and having the spray drooping; but whether this is a true variety, or only a variation, is uncertain. A portrait of a tree of this description, now growing in the garden of J. F. M. Dovaston, Esq., at West Felton, near Shrewsbury, will be found in a future page. If the appearance of Mr. Dovaston's tree, which is monoecious, be permanent, it well deserves propagation, both on account of its pendulous shoots, and because it is monoecious. Ortega states that the yew, which grows wild in different parts of Arragon, flowers in May, June, and July, and ripens its fruit in November; from which it would appear to be a different variety from that of central and northern Europe; because the difference of time between the flowering of the common yew in Paris and Stockholm does not exceed a month. Gleditsch thinks there may be two species; one indigenous to the south of Europe, and the other to the north; founding his opinion upon the circumstance of some plants being much more tender than others. This is the case even in France, where, according to Du Hamel, many yews were destroyed by the severe frost of 1709; and, according to Malesherbes, many died in his plantations in the winter of 1789. In every case where plants are raised from seed, there will be different degrees of hardiness, as well as variations in other respects; and hence, in a severe season, all the tenderer varieties of an indigenous species may be killed, while all the hardy ones stand uninjured.

Description, &c. The yew tree rises from the ground with a short but straight trunk, which, at the height of 3 ft. or 4 ft., sends out numerous spreading branches, forming a dense head, usually, when full grown, from 30 ft. to 40 ft. in height; and always characterised, till the tree attains a great age, by the tuftings and sky outline being pointed or peaked; though, after the tree has begun to decay, these become rounded or stag-headed. The trunk and branches are channelled longitudinally, and are generally rough, from the protruding remains of shoots which have decayed and dropped off. The bark is

smooth, thin, of a brown colour, and scales off, like that of a platanus; the leaves are scattered, nearly sessile, dichotomous (that is, in two lateral rows), linear, entire, very slightly revolute, and about 1 in. long; dark green, smooth and shining above; paler, with a prominent midrib, beneath; terminating in a small harmless point. Flowers axillary, solitary, each from a scaly imbricated bud; the male ones light brown, white with abundant pollen; and the female ones green, resembling, with their scaly bractees, a little acorn. The stamens vary from 5 to 10, and the divisions of the anthers from 4 to 8. Fruit drooping, consisting of a sweet, internally glutinous, scarlet berry, open at the top, enclosing a brown oval nut, unconnected with the fleshy part. Sometimes this nut is longer than the fleshy cup in which it is embedded; in which case it has the appearance of a small acorn; but, in general, the point of the nut is lower than the rim of the cup. The nut contains a kernel, which is eatable, and has an agreeable flavour like those of the stone pine. The yew is of slow growth; but, in favourable situations, it will attain the height of 6 ft. or 8 ft., or more, in 10 years from the seed. In 20 years, it will attain the height of 15 ft., and it will continue growing for 100 years; after which it becomes comparatively stationary, but will live for many centuries. When drawn up by other trees, or by being planted in masses, it takes somewhat the character of a fir; and may be found, thus circumstanced, with a clear trunk 30 ft. or 40 ft. high. It stoles when cut down under 20 or 30 years of age, but rarely when it is older. The largest tree which we have heard of in England is in the churchyard at Harlington, near Hounslow, where it is 58 ft. high, with a trunk 9 ft., and a head 50 ft. in diameter; and the oldest are at Fountains Abbey, where they are supposed to have been large trees at the time the abbey was founded, in 1132. Fig. 1983. is a portrait of one of these trees, to a scale of 1 in. to 50 ft.; and a portrait of another, to a larger scale, will be given in a future page.



Geography. The yew is indigenous to most parts of Europe, from north lat. 56° to the Mediterranean Sea; and also to the east and west of Asia; and on the supposition that *T. canadensis* is only a variety of *T. baccata*, which we believe to be the case, the common yew is also a native of North America, in Maryland, Canada, and other places. In a wild state, it is confined to shady places, such as the north side of steep hills, or among tall deciduous trees; and is always found on a clayey, loamy, or calcareous soil, which is naturally moist. It sometimes grows in the clefts of dry rocks, but never on sandy plains; and hence it is wanting in the Russian empire, except on the mountains of the Crimea, and in Caucasus. It is found in every part of Britain, and also in Ireland: on limestone cliffs, and in mountainous woods, in the south of England; and on schistous, basaltic, and other rocks, in the north of England: and, in Scotland, it is particularly abundant on the north side of the mountains near Loch Lomond. In Ireland, it grows in the crevices of rocks, at an elevation of 1200 ft.; but at that height it assumes the appearance of a low shrub. According to Templeton, it is rarely, if ever, found there in a state which can be considered truly wild. The yew is rather a solitary than a social tree; being generally found either alone, or with trees of a different species. In England, and also, as Pallas informs us, on Caucasus, it grows under the shade of the beech, which few other evergreens will do.

History, &c. The yew, and its use for making bows, are mentioned by the earliest Greek and Roman authors; and its poisonous properties are pointed out by Dioscorides, Nicander, Galen, Pliny, and others. Theophrastus says (lib. iii.) that the leaves will poison horses. Cæsar mentions that Cativolces, king of the Eburones, poisoned himself with the juice of the yew. (*De Bell. Gall.*, lib. iv.) Suetonius asserts that the Emperor Claudius published an edict, stating that the juice of this tree had a marvellous power in curing the

bite of vipers. Plutarch says that it is venomous when it is in flower, because the tree is then full of sap; and that its shade is fatal to all who sleep under it. Pliny adds to the above, that the berries of the male yew are a mortal poison, particularly in Spain; and that persons have died, who have drunk wine out of casks made of the wood. (Lib. xvi. cap. 10.) Also, that, according to Sextius, in Arcadia it was death to lie beneath the shade of the yew. In more modern times, Mathiolus and J. Bauhin were the first to prove, by positive facts, the poisonous nature of the leaves of the yew; but Father Schoot, a Jesuit, asserted that, if the branches of the tree were dipped in stagnant water, their poison became neutralised. Gerard and L'Obel soon afterwards discovered that the fruit of the yew might be eaten with perfect safety, and that there was no danger in sleeping beneath the shade of the tree.

The yew was formerly much valued in Britain, on account of the use made of its wood for bows, this weapon being that principally used by the ancient Britons in all their wars. It was fatal to several British kings; viz., Harold, at the battle of Hastings; William Rufus, in the New Forest; and Richard Cœur de Lion, at Limoges, in France. It was to the skill of the English with the long bow that the conquest of Ireland by Henry II., in 1172, is attributed; and afterwards the victories of Cressy, Poitiers, and Agincourt. In 1397, Richard II., holding a parliament in a temporary building, on account of the wretched state of Westminster Hall, surrounded his hut with 4,000 Cheshire archers, armed with tough yew bows, to insure the freedom of debate. (*Pennant's London*, ed. 3., p. 39.) Statutes were passed by many of our early British sovereigns forbidding the exportation of yew wood, and obliging all Venetian and other carrying ships to import 10 bow-staves with every butt of Malmsey or other wine; and, by the 5th of Edward IV., every Englishman dwelling in Ireland was expressly ordered to have an English bow of his own height, made of yew, wych hazel, ash, or awburne; that is, according to some, l'abour, or the laburnum, which was as much used on the Continent for making bows as the yew was in Britain (see p. 590.); or, according to others, the alder. "As for brasell, elme, wych, and ashe," says Roger Ascham, "experience doth prove them to be mean for bowes; and so to conclude, ewe of all other things is that whereof perfite shootinge would have a bowe made." The last statute that appears in the books, respecting the use of yew for bows, is the 13th of Elizabeth, c. 14., which directs that bow-staves shall be imported into England from the Hanse Towns, and other places. In Switzerland, where the yew tree is scarce, it was formerly forbidden, under heavy penalties, to cut down the tree for any other purpose than to make bows of the wood. The Swiss mountaineers call it William's tree, in memory of William Tell.

The custom of planting yew trees in churchyards has never been satisfactorily explained. Some have supposed that the yew trees were placed near the churches for the purpose of affording branches on Palm Sunday; others, that they might be safe there from cattle, on account of their value for making bows; others, that they were emblematical of silence and death; and others, that they were useful for the purpose of affording shade or shelter to those who came too soon for the service. The subject has occupied the attention of various writers; of whom the last who has taken a comprehensive view of it is J. E. Bowman, Esq., F.L.S., from whose article, in the *Magazine of Natural History*, vol. i., new series, we give the following abridged abstract:—
 "Many reasons have been assigned for the frequent occurrence of the yew in our churchyards: but it seems most natural and simple to believe that, being indisputably indigenous, and being, from its perennial verdure, its longevity, and the durability of its wood, at once an emblem and a specimen of immortality, its branches would be employed by our pagan ancestors, on their first arrival here, as the best substitute for the cypress, to deck the graves of the dead, and for other sacred purposes. As it is the policy of innovators in religion to avoid unnecessary interference with matters not essential, these, with many other customs of heathen origin, would be retained and engrafted

on Christianity on its first introduction. It would indeed be surprising, if one so innocent and so congenial to their best feelings were not allowed, as a tribute to departed worth or friendship, under that new and purer system, which confirmed to them the cheering prospect of a reunion after death with those who had shared their pleasures and affections here. History and tradition concur in telling us that this was the case, and that the yew was also closely connected, in the superstitions of our simple forefathers, with ghosts and fairies.

"In the works of a very ancient Welsh bard, we are told of two churches renowned for their prodigious yew trees:—

* Bangor Esgor, a Bangelbyr Hênllan
Ysidd er cloedvan er clyd Ywys ;'

which Dr. Owen Pugh thus translates:—'The Minster of Esgor, and that of Hênllan, of celebrity for sheltering yews.' Hênllan signifies an *old grove*; thus proving that its church stood where druid worship had been performed. Can we, then, longer doubt the real origin of planting yew trees in our churchyards? If it be said that this usual, though not natural, situation of the yew tree proves the venerable specimens which we find in churchyards not to be older than the introduction of Christianity, it may be replied, that our earliest Christian churches were generally erected on the site of a heathen temple, and that at least one motive for placing churches in such situations would be their proximity to trees already sacred, venerable for size, and indispensable in their religious rites. That these rites were performed, and altars erected, in groves, from the remotest antiquity, we know from the Pentateuch. The devotions and sacrifices of Baal among the Moabites, and the idolatrous rites of the Canaanites and other tribes of Gentiles, were performed in groves and high places. The druids chose for their places of worship the tops of wooded hills, where, as they allowed no *covered* temples, they cleared out an open space, and there erected their circles of stone. Many of the remote Welsh churches are on little eminences among wooded hills. Mr. Rootsey of Bristol has suggested that our words kirk and church might probably have originated in the word *cerrig*, a stone or circle of stones; the first churches having been placed within these circular stone enclosures. Hence also, perhaps, *caer*, a camp, which word is used in some parts of Wales for the wall round a churchyard. Dr. Stukeley believes that *round* churches are the most ancient in England. A circle was a sacred symbol among the Eastern nations of antiquity; and it would be interesting to know whether the raised platform within a circle of stones, which is sometimes found round our old yews, as in Darley and Llanfoist churchyards, be not a remnant of this superstition. Many of the first Christian churches were built and intertwined with green boughs on the sites of druidical groves. When Augustine was sent by Gregory the Great to preach Christianity in Britain, he was particularly enjoined *not to destroy the heathen temples*, but only to remove the images, to wash the walls with holy water, to erect altars, &c., and so *convert them into Christian churches*. These were the *designata loca Gentilium*, in which our converted ancestors performed their first Christian worship. *Llan*, so general a name for towns and villages in Wales, is a corruption of the British *llwyn*, a grove; and, strictly, means an enclosure, rather than a church, the places so designated being, probably, the earliest-inhabited spots, and also those where religious rites would be celebrated. (See p. 1717.) *Eglwys* means a Christian church (*ecclesia*); and, probably, those were so called which were first erected after the introduction of Christianity, and not on the site of a heathen temple." (*Mag. Nat. Hist.*, 2d series, vol. i. p. 87.)

The Rev. W. T. Bree, in the *Magazine of Natural History*, vol. vi. p. 48., also suggests the probability of churches having been built in yew groves, or near large old yew trees, as greater than that of the yew trees having been planted in the churchyards after the churches were built. A consecrated yew (according to a tale quoted in Martyn's *Miller*, and taken from the ancient laws of Wales,) was worth a pound, while a wood yew tree was worth

only fifteen pence; a circumstance which renders it probable that some particular ideas of sanctity were attached to the churchyard yews, and that they only were employed in religious ceremonies.

The history of the yew, as a garden tree, is involved in obscurity. There is no evidence that it was used, either for hedges, or for being clipped into artificial shapes, by the Romans; and, therefore, it is probable that it was first so employed in the west of Europe, and, in all probability, in France. In England, clipped yews, whether as hedges or garden ornaments, were not common in the early part of Evelyn's time; for that author claims, "without vanity," the merit of having been the first who brought the yew "into fashion, as well for defence [meaning in hedges], as for a succedaneum to cypress, whether in hedges or pyramids, conic spires, bowls, or what other shapes; adorning the parks or larger avenues with their lofty tops, 30 ft. high, and braving all the effects of the most rigid winter, which cypress cannot weather. I do again," he continues, "name the yew, for hedges, preferable, for beauty and a stiff defence, to any plant I have ever seen." (*Hist. Eccl.*, i. p. 261.) The practice of clipping the yew and other trees into the shapes of animals and geometrical forms seems to have been most prevalent from the time of Charles I. to the latter end of William III., when it gradually gave way. Bradley, writing in 1717 (*New Improvements*, p. 72.), says of the yew,—"I have seen great varieties of figures, very well represented, of men, beasts, birds, ships, and the like; but the most common shapes which have been given to the yew by gardeners are either cones or pyramids." He prefers the yew for clipping into forms of animals, on account of the smallness of its leaves; adding that "the holly, and other broad-leaved evergreens, are not fit for being cut into any nicer figures" than pyramids, balls, or a straight stem with a top like the cap of a mushroom. Switzer, writing about the same time as Bradley, ventures to doubt the beauty of these figures; but the final blow was given to them in the time of Queen Anne, by Bridgman, in Richmond Park; and by Pope, in a paper in the *Guardian*, vol. ii. No. 174. The yew still continues to be clipped in the form of hedges; and in some places, for example in some of the college gardens at Oxford, these hedges exhibit niches, arcades, and pilasters. There are a few very old gardens in England, such as at Wroxton, near Banbury, Stanstead, near Chichester, and Leven's Grove, in Westmoreland, where the yew may still be seen cut into singular shapes, as ornaments to regularly clipped hedges, and to ancient flower-gardens. The effect of these is so striking and singular, that we are surprised the taste has not, to a certain extent, been revived. This, we have no doubt, it will be, in the gardens to Gothic and Elizabethan villas, as soon as men exercise their reason in matters of this kind, and do not allow themselves to be led indiscriminately by fashion.

It may be mentioned, as a historical fact connected with the yew, that De Candolle has adopted this tree as a sort of standard by which to determine the age of trees generally, from the number of layers of wood in their trunks. The reasons why he preferred the yew appear to be, that of this tree there are a greater number of authentic records of the age of individual specimens than in the case of most other trees; because the tree is very generally distributed throughout Europe; and, finally and chiefly, because the wood is of slower growth and greater durability than that of any other European tree. De Candolle, in his *Physiologie Végétale*, tom. ii. p. 974. and 1001., and also in an article published in the *Bibliothèque Universelle de Genève*, says that measurements of the layers of three yews, one of 71, another of 150, and a third of 280 years old, agreed in proving that this tree grows a little more than one line annually in diameter in the first 150 years, and a little less from 150 to 250 years. He adds, "If we admit an average of a line annually for very old yews, it is probably within the truth; and, in reckoning the number of their years as equal to that of the lines of their diameter, we shall make them to be younger than they actually are." The justness of Professor De Candolle's conclusion has been questioned by Professor Henslow, and other

botanists, and more especially by Mr. Bowman, in an article in the *Magazine of Natural History*, vol. i., new series. Mr. Bowman considers a line a year, in the case of the yew, not nearly enough; having tested it with two yew trees, the age of which he knew, and found that, in the one case, the tree was made 200 years, and in the other 650 years, less than their real age. The experiments of this gentleman tend to show that De Candolle's average of a line a year makes old yews too young, and young yews too old: for the latter he would allow two, and in case of rich soil even three, lines a year till the plants had trunks 2 ft. in diameter, when, with De Candolle, he would allow one line a year. So much, however, depends on the nature of the soil in which the tree grows, that, for our own part, we can place but very little reliance on any data of this kind.

Biography of celebrated Yew Trees. We shall select a few of the more remarkable of these, arranging them according to their celebrity, and commencing with those of England. We think we shall be justified in doing this, from the great interest which attaches to the yew tree; not only in Britain, but throughout Europe.

The Yew Trees at Fountains Abbey, in Yorkshire, are well known. This abbey was founded in 1132, by Thurston, Archbishop of York, for certain monks, who separated themselves from the Benedictine Abbey of St. Mary's, in York, in order to adopt the more severe discipline of St. Bernard, who had just then founded the Cistercian order at Clairvaux, in Champagne. The history of Fountains Abbey is minutely related by Burton, from the narrative of Hugh, a monk of Kirkstall, which is said to be now preserved in the library of the Royal Society:—"At Christmas, the archbishop, being at Ripon, assigned to the monks some land in the patrimony of St. Peter, about three miles west of that place, for the erecting of a monastery. This spot of ground had never been inhabited, unless by wild beasts; being overgrown with wood and brambles, lying between two steep hills and rocks, covered with wood on all sides, more proper for a retreat for wild beasts than the human species. This was called Skeldale; that is, the vale of the Skell, from a rivulet of that name running through it from the west to the eastward part. The prior of St. Mary's, at York, was chosen abbot by the monks, being the first of this monastery of Fountains, with whom they withdrew into this uncouth desert, without any house to shelter them in that winter season, or provisions to subsist on, but entirely depending on Divine Providence. There stood a large elm tree in the midst of the vale, on the lower branches of which they put some thatch and straw; and under that they lay, ate, and prayed; the bishop, for a time, supplying them with bread, and the rivulet with drink. Part of the day some spent in making wattles, to erect a little oratory; whilst others cleared some ground to make a little garden. But it is supposed that they soon changed the shelter of their elm for that of seven yew trees, growing on the declivity of the hill on the south side of the abbey, all standing at this present time (1658), except the largest, which was blown down about the middle of the last century. They are of extraordinary size: the trunk of one of them is 26 ft. 6 in. in circumference at 3 ft. from the ground; and they stand so near each other as to form a cover almost equal to a thatched roof. Under these trees, we are told by tradition, the monks resided till they had built the monastery." (*Burton's Monast.*, fol. 141.; *Strutt's Sylva*, p. 118.; and *Sopwith's Fountains Abbey*, p. 1.) The name of Fountains Abbey is derived by some from Fountaines, in Burgundy, the birthplace of St. Bernard; and by others from the word *skell*, which, signifying a fountain, was written in Latin, by the monks, *fontibus*, and thence corrupted into the present name. (*Sop.*, l. c.) A portrait of one of these celebrated trees is given by Strutt, from which our *fig.* 1984. is a copy. The tree is upwards of 50 ft. high; and, if it existed, and was a large tree, previously to 1132, it must, in 1837, be upwards of 600 years old.

The Buckland Yew. This tree (of which *fig.* 1985. is a portrait) is situ-

1984



ated in Buckland churchyard, about a mile from Dover; and, according to an account given of it by the Rev. W. T. Bree, is of great antiquity and singular formation. About the middle of the last century, the tree "was shattered by lightning, which, at the same time, demolished also the steeple of the church, close to which it stands. To this catastrophe, no doubt, is to be attributed, in a great measure, much of the rude and grotesque appearance which it now presents. At a yard from the ground, the but, which is hollow, and, on one side, extremely tortuous and irregular, protruding its 'knotted fangs,' like knees, at the height of some feet from the surface, measures 24 ft. in circumference. It is split from the bottom into two portions; one of which, at the height of about 6 ft., again divides naturally into two parts; so that the tree consists of a short equal but, branching out into three main arms; the whole not exceeding in height, to the extreme top of the branches, more than about 25 ft. or 30 ft. Of what may be regarded as the original trunk and arms but little now remains alive: two considerable portions, however, are still conspicuous in the state of dead wood; viz. one on the inner part of the northern limb, hollow, and forming a sort of tunnel or chimney; the other on the western limb, more solid, and exhibiting the grain of the wood singularly gnarled and contorted. These, which are probably portions of the original trunk and arms, are partly encased, as it were,



on the outside by living wood of more recent growth (as is frequently seen to be the case in other old and decayed trees); the dead portions seeming to evince a disposition to slough out, like fragments of carious bone separating from the flesh; but they are kept fixed in their position by the living wood lapping over as it does, and clasping them firmly. The encasing of the old dead wood by that of more modern formation is well displayed, also, in one part of the southern limb of the tree, where an aperture occurs, which exposes to view the dead wood completely enveloped and embedded within the living. The trunk is decayed, and hollow at the bottom; but from within the shell there arise two or more vigorous detached portions, of small diameter, which soon unite with the main wood, and run up to a considerable height, lapping into one another, and twisting and interlacing in a very striking manner, so as to suggest the idea that the trunk has been ripped open, and is now exposing to view its very entrails. Imagination, indeed, might readily trace a fanciful resemblance between this vegetable ruin, as viewed in a particular position, and some anatomical preparation of an animal trunk, of which the viscera are displayed, and preserved entire." (*Mag. Nat. Hist.*, vol. vi.)

The Tytherley Yews. There are two yew trees in the churchyard at Queenwood, near Tytherly, in Wiltshire, which are above 500 years old; the largest is 28 ft. high; diameter of the trunk 3 ft. 6 in., and of the head 50 ft. There is, in the same wood, an avenue 414 yards long, consisting of 162 yew trees, which are supposed to be about 200 years old. They average 30 ft. high, with trunks about 2 ft. in diameter at 2 ft. from the ground; and heads about 30 ft. in diameter. Another avenue planted about 160 years ago, and 400 yards long, consists of 120 trees, averaging about 24 ft. high, with trunks about 2 ft. in diameter. The width of both avenues is rather more than 30 ft. There are about 100 more yew trees on the Tytherly estate, but they are of smaller dimensions than those already noticed.

The Tisbury Yew. "In the churchyard of Tisbury, in Dorsetshire, there is now standing, and in fine foliage, although the trunk is quite hollow, an immense yew tree, which measures 37 ft. in circumference, and the limbs are proportionably large. The tree is entered by means of a rustic gate; and seventeen persons lately breakfasted in its interior. It is said to have been planted, many generations ago, by the Arundel family." (*Lauder's Gilpin.*)

The Iffley Yew stands in Iffley churchyard, near Oxford, nearly opposite the south-east corner of the church, and between that and an ancient cross. This tree is supposed to be coeval with the church, which, it is believed, was built previously to the Norman conquest. The dimensions of the tree, kindly taken for us in September, 1836, by Mr. Baxter, were as follows:—Girth of the trunk, at 2 ft. from the ground, 20 ft., and at 4 ft. from the ground, where the branches begin, 17 ft. The trunk is now little more than a shell, and there is an opening on the east side of the tree which is 4 ft. high, and about 4 ft. in width; the cavity within is 7 ft. long, 4 ft. wide, and 4 ft. high in the highest part. The height of the tree is 22 ft.; and there are about 20 principal branches, all of which, except two, are in a very vigorous and flourishing state. The diameter of the head is 25 ft. each way. A very good, but very small, figure of this tree may be seen in the south-west view of Iffley church, given in the *Memorials of Oxford*, No. 31. It is also seen in a woodcut of the north-east view, close to the corner of the chancel, in the same work.

A large Yew Hedge in the Oxford Botanic Garden, which was rooted up in 1834, had its branches crossing each other in various directions, and so completely inoculated, that after the hedge was cut down, they were formed, without nailing, into the backs of rustic garden chairs, and similar articles; several of which are now preserved in the botanic garden.

The Ankerwyke Yew, near Staines, of which a figure is given by Strutt, is supposed to be upwards of 1000 years old. Henry VIII. was said to have made it his place of meeting with Anna Boleyn, while she was living at Staines; and Magna Charta was signed within sight of it, on the island in the Thames between Runnymede and Ankerwyke. The girth of this tree, at 3 ft. from the ground, is 27 ft. 8 in.; and at 8 ft. it is 32 ft. 5 in.; it then throws out five principal branches, and at 12 ft. numerous others, which form a magnificent head, 49 ft. 6 in. high, and 69 ft. in diameter. The following lines on this tree are quoted by Strutt:—

"What scenes have pass'd, since first this ancient yew,
In all the strength of youthful beauty grew!

Here too, the tyrant Henry felt love's flame,
And, sighing, breathed his Anna Boleyn's name.
Beneath the shelter of this yew tree's shade
The royal lover woo'd the ill-starr'd maid:
And yet that neck, round which he fondly hung,
To hear the thrilling accents of her tongue;
That lovely breast, on which his head reclined,
Form'd to have humanis'd his savage mind;
Were doom'd to bleed beneath the tyrant's steel,
Whose selfish heart could doat, but could not feel."

The Arlington, or Harlington, Yew stands in the churchyard of the village of that name, between Brentford and Hounslow. It is chiefly remarkable for its large size, and for having once been clipped into the regular form shown in *fig. 1986*. This engraving is copied from a print of the tree, as it appeared in November, 1729; and this print is accompanied by a copy of verses by "Poet John Saxy," from which it appears that it must at that time have been between 50 ft. and 60 ft. in height. It was surrounded at the bottom of its trunk by a wooden seat, above which, at 10 ft. from the ground, was a large circular canopy, formed by the tree itself, which was, according to "Poet Saxy" (who was clerk of the parish),—

"So thick, so fine, so fast, so wide,
A troop of guards might under it ride."

Two feet above this canopy was another, of much smaller dimensions; and

above that a pyramid, about 20 ft. high, surmounted by a globe 10 ft. high; and the globe was crowned by

"A weathercock, who gaped to crow it,
This world is mine, and all below it."

The tree ceased to be clipped, we are informed by the present clerk of the parish, about 1780 or 1790; and it is now suffered to assume its natural shape, as shown in the portrait of the tree in our last Volume.

The Darley Yew. This ancient tree stands in the churchyard of Darley in the Dale, Derbyshire. It is a female, with a solid trunk, forking, at 7 ft. above the ground, into two nearly upright boughs, which reach a height of about 55 ft.; but its head has not the breadth or luxuriance of the Gresford Yew, mentioned below. Its circumference at the base is 27 ft.; at 2 ft. 4 in. above the ground, 27 ft. 7 in.; at 4 ft., 31 ft. 8 in.; and at 6 ft., 30 ft. 7 in. At 4 ft. high there are excrescences which swell the trunk beyond its natural size; but the mean of the three other dimensions gives a circumference of 28 ft. 4 in., and a diameter of 9 ft. 5 in., disregarding fractional parts. The mean diameter of the tree is, therefore, 1356 lines, which, according to De Candolle's method of calculating the age of trees, would also be the number of its years.

The Mamhilad Yew (fig. 1987.) stands in the churchyard of Mamhilad, a few miles north of Pontypool: it is a female; and, 2 ft. 6 in. from the ground, where the trunk has a fair medium thickness, it measures 29 ft. 4 in. in circumference. At about 4 ft. high, it divides into six main boughs, one of which is quite decayed. The trunk is hollow; and, on the north side, it has an opening down to the ground, which is gradually contracting on both sides by

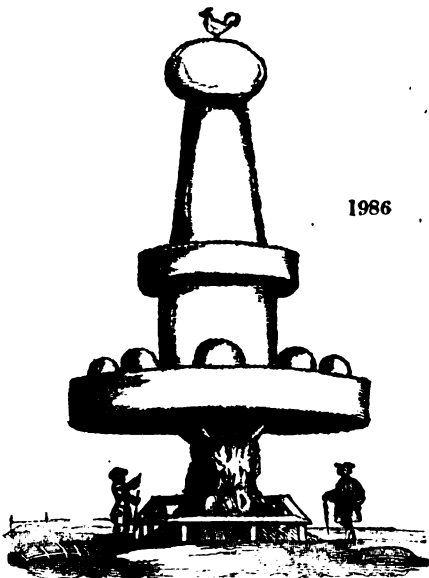

annual deposits of new wood. Within this opening, and in the centre of the original tree, is seen another, and apparently detached, yew, several feet

in diameter, covered with bark, and in a state of vigorous growth: it is, in fact, of itself a great tree, and overtops the old one. On examination, however, it is found to be united behind, and also at some distance from the ground, by two great contorted arms, one on each side, to the inner wall of its decaying parent; being a curious example of natural inarching, and having altogether a very striking and singular appearance.

The Llanthewy Vach Yew. This tree, a male, which stands in the churchyard of Llanthewy Vach, near Caerleon, measures 30 ft. 4 in. in circumference at 3 ft. from the ground; and, like the last, has a stunted and hollow trunk, with a lateral opening, and will hold five or six persons. It has also in the centre a still more remarkable inner trunk, covered with bark, quite detached and distinct from the old trunk below, but united with it above by a great branch running into, or more probably proceeding from, it.

The Gresford Yew, of which fig. 1988. is a portrait, stands in the south-east corner of Gresford churchyard, near Wrexham, Denbighshire. The

1988



circumference of the trunk, at 5 ft. 3 in. from the ground (being at the point of divarication of the main branches), is 29 ft.; and at the very base, it is 22 ft.; from the trunk to the extremity of the branches, on the south side

(being their greatest extension), it is 36 ft.; and the height of the tree is 52 ft. "This noble yew," Mr. Bowman observes, "has seven main branches; and most of these divide again, very near the trunk, into two or three smaller ones. The tree, which is a male, is still full of foliage, and of great beauty, as well as venerable for its size; and it shows no symptoms of natural decay. (*J. E. B. July, 1836.*)

The *Ystrad Eftur*, or *Strada Florida Yews*, are mentioned by Lleland, as growing in a cemetery of that name in South Wales. There were originally 39, but there are only three remaining, under one of which, tradition says, the Welsh poet, David Ap Gwyllim, was buried.

In Scotland, there are some remarkable yew trees.

The *Loudon Yew*, at Loudon Castle in Ayrshire, is 42 ft. high, with a trunk 4 ft. 6 in. in diameter at 12 ft. from the ground, and a head 195 ft. in circumference. Under this tree, it is said, Bruce bestowed the ancient castle and estate on the Loudon family; and, some centuries afterwards, John Earl of Loudon signed the act of union between England and Scotland. When the present castle was built, a curve was made in the wall to avoid injuring the yew.

The *Crupton Yew* stood close by Crupton Castle; and under its shade tradition says that Queen Mary gave her consent to marry Darnley, to perpetuate the memory of which, she had the figure of a yew tree stamped on her coins. J. Maxwell, Esq., M.P., whose residence at Polloc commands a view of Crupton Castle, informs us that this yew has been dead many years; but that he has preserved a portion of its trunk. He has also a young tree, raised from it by layering, which he intends to plant on the site of the old one, as soon as it attains sufficient size.

The *Dryburgh Yew* stands close to the Abbey of Dryburgh, in Roxburghshire, and is supposed to have been planted at the time the abbey was founded, in 1136. Sir William Jardine informs us that it is now (1837) in perfect health, and growing a few inches yearly; and that the tree, from its standing quite alone, has its branches spreading on every side, so as to form a regular head 50 ft. in diameter. The circumference of the trunk, at 1 ft. from the ground, is only 12 ft.

The *Fortingal Yew* (*fig. 1989.*) stands in the churchyard of Fortingal, or the Fort of the Strangers, so called from its being in the vicinity of a small



Roman camp, lying in the wild romantic district at the entrance to Glen Lyon, in Perthshire. Its age is unknown, but it has long been a mere shell, forming an arch, through which the funeral processions of the highlanders were accustomed to pass. It was first described in the *Philosophical Transactions* (vol. lxx.), in 1769, by the Honourable Daines Barrington, who found

it 52 ft. in circumference; and, some years afterwards, by Mr. Peanant, when the circumference had increased to 56 ft. 6 in. Dr. Neill visited the tree in July, 1833; and a notice of it by him will be found in the *Edinburgh Philosophical Journal* for that year, from which we make the following extract; premising that, when Daines Barrington measured the tree, he found one side of the trunk a mere shell of bark, all the interior having decayed. "Considerable spoliations," Dr. Neill observes, "have evidently been committed on the tree since 1769; large arms have been removed, and masses of the trunk itself carried off by the country people, with the view of forming *quacks*, or drinking-cups, and other relics, which visitors were in the habit of purchasing. What still exists of the trunk now (1833) presents the appearance of a semicircular wall, exclusive of the remains of some decayed portions of it, which scarcely rise above the ground. Great quantities of new spray have issued from the firmer parts of the bark, and a few young branches spring upwards to the height, perhaps, of 30 ft. The side of the trunk now existing gives a diameter of more than 15 ft., so that it is easy to conceive that the circumference of the bole, when entire, should have exceeded 50 ft. Happily, further depredations have been prevented by means of an iron rail, which now surrounds the sacred spot; and this venerable yew, which, in all probability, was a flourishing tree at the commencement of the Christian era, may yet survive for centuries to come."

The Loch Lomond Yew. According to Sir Thomas Dick Lauder, a yew in the Island of Inch Lonach, or what is commonly called the Yew Tree Island, in Loch Lomond, measured on the 3d of August, 1770, was 10 ft. 7 in. in circumference. This tree was about 40 ft. high; but another tree, which was the largest in the island, though not so tall, measured 13 ft. in girt. It is uncertain whether these trees were sacrificed among the 300 yew trees which were cut on this spot. There has been, for many years, a herd of deer in the Yew Tree Island, which has prevented young trees from rising from the seed; but many of those which have begun to decay have sent up shoots from their roots, close to the old trunk. After a time, a number of these shoots coalesce, and form at last a complete new trunk, at the side of which the old one continues to decay. In this way the tree comes to be regenerated from the root.

The Bernera Yew. According to the same authority, in the Island of Bernera, adjacent to the Sound of Mull, the late Sir Duncan Campbell cut down a yew of vast size. Its precise dimensions were not preserved, but the timber of it deeply loaded a highland 6-oared boat, and was sufficient to form a large elegant staircase in the house of Lochnell, which was afterwards destroyed when the house was burned down. (*Laud. Gisp.*)

The Ormiston Yew. One of the most beautiful yew trees in Scotland is that growing in the garden at Ormiston Hall, a seat of the Earl of Hopetoun, in Haddingtonshire. It throws out its vast limbs horizontally in all directions, supporting a large and luxuriant head, which now (1834) covers an area of ground of 58 ft. in diameter, with a most impenetrable shade. Above the roots it measures 12 ft. 9 in. in girt; at 3 ft. up, it measures 13 ft. 6 in.; at 4 ft. up, it measures 14 ft. 9 in.; and at 5 ft. up, it measures 17 ft. 8 in. It is in full health and vigour. (*Ibid.*, i. p. 279.)

In Ireland, the yew tree, as already observed, can scarcely be considered as to be found any where now in a wild state; though, as we have seen, p. 106., trunks of very large yew trees have occasionally been dug out of bogs.

The Mucrus Abbey Yew stands in the centre of a cloistered court, now in ruins, and is supposed to be coeval with the abbey. As the abbey was in existence, and celebrated as a sanctuary, in the year 1180, the tree must be upwards of 700 years old. Arthur Young saw it about 1780, and states it to be, without exception, the most prodigious yew tree he ever beheld. Its trunk, he says, is 2 ft. in diameter at 14 ft. high, whence a vast head of branches spreads on every side, so as to form a perfect canopy to the whole space. (*Tour in Ireland*, 1780, i. p. 443.) Percival Hunter informs us (writing in 1836) that

the tree stands quite erect; that the trunk is destitute of branches for some way up; and that the head still continues to grow.

Yews remarkable for some Singularity in their Form, Mode of Growth, or Situation. The yew being one of the trees most frequently subjected to the shears in former times, is occasionally to be met with clipped into artificial forms; but those singularities of form which we intend to notice here will be chiefly such as have arisen from fortuitous circumstances. The most remarkable clipped yew tree that we recollect, in the neighbourhood of London, is one in the churchyard at Hounslow; the sides of which are formed into square plinths and cylinders, and the top into a cock. There is a similar tree in the churchyard at Beaconsfield. The clipped tree at Harlington (noticed in p. 2077.), which must have been one of the grandest things of its kind of the time, is, as already observed, no longer subjected to the shears.

The Crum Castle Yew Tree "grows on a small mound of earth, 4 ft. above the level of the surrounding surface. Its branches were formerly supported by 32 brick pillars, 6 ft. high; but these were removed about three years ago, and it is now supported by 16 oak posts with their bark on, which look more in character with the tree. Its height is 18 ft. 6 in.; the trunk is 9 ft. 3 in. in girth at 1 ft. 6 in. from the ground; and the space covered by the branches is 70 ft. 6 in. in diameter. Its branches are so interwoven and platted together through each other, that it is almost impossible to trace any one of them from the trunk to its extremity. This, indeed, is the cause of the very remarkable appearance of the tree: but at what time, or by whose hands, this labour was performed, is unknown. The tree is supposed to be three or four centuries old, and has rather the appearance of being on the decline. It was highly valued by the late Earl of Erne, who frequently employed men to clean the moss from its branches. It is a female plant, and bears annually abundance of fruit. This singular tree is surrounded by a yew hedge, which is kept neatly clipped. — *W. Henderson. Crum Castle, March, 1836.*"

The Portbury Yews. In the churchyard of Portbury, near Bristol, are two very lofty yews, much longer in the bole than usual. One of these, in August, 1836, had a small branch from the base of a bough, which had shot downwards into the decayed top of the trunk; and which, on being pulled up, proved to be a perfect root, upwards of 3 ft. in length. This singular circumstance will explain the origin of the inner trunks of yew trees, as exemplified in that of Mamhilad, already described, p. 2077. When the top of the trunk becomes cracked by the action of storms upon the boughs, the rain finds access, and, in time, causes decay; and the dead leaves and dung of bats and birds, &c., falling in, combine with the rotten wood to form a soft rich mould, into which a bud shooting out from a neighbouring part (if not actually covered by the mould) is naturally drawn by the moisture and surrounding shade, and transformed into a root. As the fissure widened and deepened, by the slow but sure process of decay, this root would descend and thicken, till it ultimately fixed itself in the soil below. After a lapse of, perhaps, several centuries, decay, gradually advancing, would at last reach the circumference of the trunk, and produce a rift on one side: through this the rotten mould would fall out, gradually exposing the root it had conducted downwards; and the combined influence of light and air, acting upon its juices, would cause it to deposit annual layers of true wood, and to be covered with a true bark. Meanwhile it would have shot up a stem near its point of union, and have formed for itself an independent head and branches. All this is in strict conformity with the known laws of vegetable physiology; and some similar process has produced the peculiarities already described in the Mamhilad and Llanthewy Vach yews. In the Portbury tree, the same process is shown in its earlier stage; and these examples make it probable that, under favourable circumstances, the yew has the power of thus perpetuating itself. If so, it may be said to have a new claim to be considered the emblem of immortality. There is no doubt that, barring accidents, the inner trunks of the

two old yew trees at Mamhilad and Llanthewy Vach will survive as independent trees when, centuries hence, the surrounding walls of their original boles shall have completely disappeared; and, should no record of their true history exist, an observer then will be quite unconscious that they are but portions of some former trees, the germ of which existed, perhaps, 3000 years ago; for the lateral scar, which would for a while mark the point of union, would, in time, be closed up and buried beneath new deposits. (Abridged from *Mag. Nat. Hist.*, vol. i. new series, p. 90.)

The Ribbesford Yew stands in the parish of that name, near Bewdley, in Worcestershire. This yew grows out of a hollow pollard oak, the circumference of the trunk of which, at the ground, is 17 ft., and its height 20 ft. In this hollow cylinder the yew has not only established itself, but grown to such a size as completely to fill up the cavity; and it will doubtless, in a few years, increase to such a size as to burst asunder the oaken shell which now encloses it, and ultimately to stand alone, as if it had sprung up from the ground. At present, both the oak and the yew have numerous spreading branches, which make a fine appearance; the dark green foliage of the yew "towering above the boughs of its aged companion." There can be no doubt that the seed of the yew was deposited in the decaying crown of the pollard, and that its roots gradually penetrated downwards till at last they reached the soil. (*The Analyst*, vol. i. p. 81.)

The Glendalough Yew, in the county of Wicklow, was an immense tree, and shaded from the sun and the storm, not only the ruins of a small church under it, but the greater part of the churchyard. Hayes was informed, on undoubted authority, that on one hot summer's day, when this tree was in its full beauty, the agent for the bishop to whom the church belonged had all its principal limbs and branches cut off close by the trunk and sold. About 40 years afterwards, when Hayes saw it, the trunk was decaying at the heart, and a holly was growing up through one of the fissures. (*Treat. on Plant.*, p. 144.)

The Westfelton Yew (fig. 1990.) stands in the grounds of J. F. M. Dovaston, Esq., at Westfelton, near Shrewsbury; and the following account has been sent to us by that gentleman:—"About 60 years ago, my father, John Dovaston, a man without education, but of unwearied industry and ingenuity, had with his own hands sunk a well, and constructed and placed a pump in it; and, the soil being light and sandy, it continually fell in: he secured it with wooden boards; but, foreseeing their speedy decay, he planted near to the well a yew tree, which he bought of a cobbler for sixpence; rightly judging that the fibrous and matting tendency of the yew roots would hold up the soil. They did so; and, independently of its utility, the yew grew into a tree of the most extraordinary and striking beauty; spreading horizontally all round to the diameter of (now, 1836) 56 ft., with a single aspiring leader to a great height; each branch in every direction dangling in tressy verdure downwards, the lower ones to the very ground, pendulous and playful as the most graceful birch or weeping willow; and visibly obedient to the feeblest breath of summer air. Its foliage is admirably adapted for retaining the dew drops; and, in consequence, it makes a splendid appearance at sunrise. Though a male tree, it has one entire branch self-productive, and exuberantly profuse in female berries, full, red, rich, and luscious; from which I have raised several plants, in the hope that they may inherit some of the beauty of their parent. The circumference of the tree now, at 5 ft. from the ground, is 5 ft. 1 in.; and it is in a growing state, quite healthy and vigorous. The drawing which accompanies this (see fig. 1990.) was made by one of the ingenious children of my friend Bowman.—J. F. M. D. *Westfelton, July, 1836.*"

Poetical and legendary Allusions. The yew has afforded numerous images to the poets, from the time of Homer, who speaks of the ancient inhabitants of Crete as being "dreadful with the bended yew," to the poets of the present day. Virgil notices the elasticity of the yew in the *Æneid*:—

1990



“ This foul reproach Ascanius could not bear
 With patience, or a vow'd revenge forbear :
 At the full stretch of both his hands, he drew,
 And almost join'd, the horns of the tough yew.”

In the *Georgics*, the yew is frequently mentioned ; and those who keep bees are cautioned not to place their hives near yew trees.

Among the old English poets, the yew is frequently mentioned ; and, as an example, we may copy the following lines from Herrick, as quoted by one of the most elegant poetesses of the present day, Miss Twamley. Herrick thus addresses the cypress and the yew : —

“ Both of you have
 Relation to the grave ;
 And where
 The fun'rale trump sounds you are there.
 I shall be made
 Ere long a fleeting shade :
 Pray come,
 And do some honor to my tomb.
 Do not deny
 My last request, for I
 Will be
 Thankful to you, or friends for me.” (See *Romance of Nature*, &c.)

Shakspeare mentions the yew as being used for bows :—

“ The very beadsmen learn to bend their bows
 Of double fatal yew against thy state.”

He also alludes to its being employed in funerals :—“ My shroud of white, stuck all with yew.” Many other poets allude to its connexion with ideas of death. Blair says, addressing himself to the grave :—

“ Well do I know thee by thy trusty yew ;
 Cheerless unsocial plant, that loves to dwell
 'Midst skulls and coffins, epitaphs and worms ;
 Where light-heeled ghosts, and visionary shades,
 Beneath the wan cold moon (so fame reports),
 Embedded thick, perform their mystic rounds :
 No other merriment, dull tree, is thine.”

Gray's lines are well known :—

" Beneath those rugged elms, that yew tree's shade,
Where heaves the turf in many a mould'ring heap,
Each in his narrow cell securely laid,
The rude forefathers of the hamlet sleep." *Elegy in a Country Churchyard.*

Swift makes Baucis and Philemon be turned to yews :—

" Description would but tire my Muse :
In short they both were turned to yews.
Old Goodman Dobson of the Green
Remembers he the trees has seen.
On Sundays, after evening prayer,
He gathers all the parish there ;
Points out the place of either yew
Here Baucis, there Philemon grew.
Till once the parson of our town,
To mend his barn, cut Baucis down ;
At which 't is hard to be believed
How much the other tree was grieved,
Grew scrubbed, died a top, was stunted ;
So the next parson stubb'd and burnt it."

Numerous other passages might be quoted, but we shall confine ourselves to two, one of which is from Sir Walter Scott, and the other from Wordsworth :—

" But here 'twixt rock and river grew
A dismal grove of sable yew,
With whose sad tints were mingled seen
The blighted fir's sepulchral green :
Seem'd that the trees their shadows cast
The earth that nourish'd them to blast,
For never knew that swarthy grove
The verdant hue that fairies love ;
Nor wilding green, nor woodland flower,
Arose within its baleful bower :
The dark and sable earth receives
Its only carpet from the leaves,
That, from the withering branches cast,
Bestrew'd the ground with every blast."

Keelby, canto. ii.

" There is a yew tree, pride of Lorton vale,
Which to this day stands single in the midst
Of its own darkness, as it stood of yore,
Not loth to furnish weapons in the hands
Of Umfraville or Percy, ere they march'd
To Scotland's heaths, or those that cross'd the sea,
And drew their sounding bows at Agincourt ;
Perhaps at earlier Cressy, or Poitiers.
Of vast circumference and gloom profound,
This solitary tree! A living thing,
Produced too slowly ever to decay ;
Of form and aspect too magnificent
To be destroy'd. But worthier still of note
Are those fraternal four of Borrowdale,
Join'd in one solemn and capacious grove ;
Huge trunks! and each particular trunk a growth
Of intertwined fibres serpentine,
Upcoiling, and immediately convolved :
Nor uninform'd by phantasy, and looks
That threaten the profane; a pillar'd shade,
Upon whose grassless floor of red brown hue,
By sheddings from the pining umbrage tinged
Perennially;— beneath whose sable roof
Of boughs, as if for festal purpose, deck'd
With unrejoicing berries, ghostly shapes
May meet at noontide,
. there to celebrate,
As in a natural temple, scatter'd o'er
With altars undisturb'd of mossy stone,
United worship."

There does not appear to be any mythological legend connected with the yew. In Lempriere's *Classical Dictionary*, it is said that *Smilax* was metamorphosed into a yew; but Ovid simply says that she, and her lover *Cleopas*, were changed into two flowers :—

" Et Crocon in parvos versum cum Smilace flores
Prætereo; dulcique animos novitate tenebo." *Met.*, lib. iv. *lin.* 10.

Probably the mistake arose from *Dioscorides*, and some of the other ancient botanists, having called the yew *Smilax*. Camden relates a legend

of a priest in Yorkshire, who, having murdered a virgin who refused to listen to his addresses, cut off her head, and hid it in a yew tree. The tree from thenceforth became holy, and people made pilgrimages to visit it, plucking and bearing away branches of it, believing that the small veins and filaments, resembling hairs, which they found between the bark and wood of the tree, were the hairs of the virgin. Hence, the name of the village, which was then called Houton, was changed to Halifax, which signifies holy hair; and the wealth brought by the pilgrims enabled the inhabitants to build on its site the now famous town of that name.

Properties and Uses. In a wild state, the yew affords food to birds by its berries; and an excellent shelter to them during severe weather, and at night, by its dense evergreen foliage, but no insects live on it. By man, the tree has been applied to various uses, both in a living state, and when felled and employed as timber. The wood is hard, compact, of a fine and close grain, flexible, elastic, splitting readily, and incorruptible. It is of a fine orange red, or deep brown; and the sap wood, which does not extend to a great depth, is white, and also very hard. Where the two woods join, there are generally different shades of red, brown, and white: both woods are susceptible of a very high polish. Varennes de Fenilles states that the wood, before it has been seasoned, when cut into thin veneers, and immersed some months in pond water, will take a purple violet colour; probably owing to the presence of alkali in the water. According to this author, the wood of the yew weighs, when green, 80 lb. 9 oz. per cubic foot; and, when dry, 61 lb. 7 oz. It requires a longer time to become perfectly dry than any other wood whatever; and it shrinks so little in drying, as not to lose above $\frac{1}{10}$ part of its bulk. The fineness of its grain is owing to the thinness of its annual layers, 280 of these being sometimes found in a piece not more than 20 in. in diameter. It is universally allowed to be the finest European wood for cabinet-making purposes. Tables made of yew, when the grain is fine, according to Gilpin, are more beautiful than tables of mahogany; and the colour of its root is said to vie with the ancient citron. It is generally employed in the form of veneers, and for inlaid work; it is also used by the turner, and made into vases, snuff-boxes, musical instruments, and a great variety of similar articles. Both the root and trunk furnish, at their ramifications, pieces of wood beautifully veined and marbled, which are highly prized. The sap wood, though of as pure a white as the wood of the holly, is easily dyed of a jet black, when it has the appearance of ebony. Where it is found in sufficient quantities to be employed for works under ground, such as water-pipes, pumps, piles, &c., the yew will last longer than any other wood. "Where your paling is most exposed either to wind or springs," says Gilpin, "strengthen it with a post of old yew. That hardy veteran fears neither storms above, nor damps below. It is a common saying among the inhabitants of New Forest, that a post of yew will outlast a post of iron." Evelyn mentions the yew trees at Box Hill as both numerous and large. Marshall, writing in 1796, says that a few of these trees which remained had then "lately been taken down, and the timber of such as were sound was sold to the cabinet-makers, at very high prices, for inlaying: one tree in particular was valued at 100*l.*, and half of it was actually sold for 50*l.* The least valuable were cut up into gate-posts, which are expected to last for ages: even stakes made from the tops of yew have been known to stand for a number of years." (*Plant. and Rur. Orn.*, ii. p. 396.) In France, the yew is found to make the strongest of all wooden axletrees. The branches furnish stakes and hoops of great durability; and the young shoots may be employed as ties, or woven into baskets, which, though heavier than those of the willow, will be of many times their strength and duration. Boucher mentions one of the uses to which the wood is applicable, which ought to render it even more in demand by the cabinet-maker than it now is; viz., that "the wooden parts of a bed made of yew will most certainly not be approached by bugs. This is a truth," he adds, "confirmed to me by the

experience of trees I had cut down, and used myself in that way." He adds that this very material quality is not mentioned by any writer, so far as he knows.

Manufacture of Bows. The principal use for which the yew was cultivated, before the introduction of gunpowder, was for making bows, which were for many centuries the principal weapons of the English. Bows are mentioned in Holy Writ; and according to the poem of *Archery Revised*, published in 1676, —

" 'T was with a shaft that Lamech murdered Cain."

The bows mentioned in Scripture, however, appear to have been composed of metal; and many of those of the ancients were made of two goat's horns joined together with a piece of wood for the handle. The first account we meet with of yew bows is in Homer; Virgil also speaks of "bows of the tough yew." In English history, bows are not mentioned till the time of the Saxons; when yew bows, the height of a man, were brought over by Vortigern, and soon became general; till, according to one of the versifiers of the 15th century, the enemies of the English in every country, —

—————" By shafts from bows of bending yew,
In streams of crimson gore paid Nature's due."

SMOTHERELL and DUFFEY's *Archery Revised*.

The battle of Agincourt, and those of Cressy and Poitiers, were chiefly gained by the skill of the English with the bow; and it was the principal weapon in the wars of York and Lancaster. There is also an edict of Edward IV., relating to the use of the long bow by the Irish. Prince Arthur in the reign of Henry VII., and after him Henry VIII., held sports of archery at Mile End; when there was created, in jest, a duke of Shoreditch, and two marquesses of Clerkenwell and Islington, and an earl of Pancras. The duke of Shoreditch was the best archer in the king's guard; and the others the next best. These dignitaries played their parts like the king and queen on Twelfth Night; and a full detail of the ceremonies will be found in Wood's *Bowman's Glory*, p. 41. Henry VIII. afterwards passed several statutes in favour of archery, of which he was a warm patron; and in his reign "Master Cheke" published the translation of a work from the Greek on the subject. In 1544, Roger Ascham published his *Taxophiles*, a work replete with the quaint learning and involved sentences of the time. After thus employing two thirds of his book, at last he begins to give directions, as he says, "in good sadnesse," for choosing a bow, and practising the art. He first states the instruments required; viz., the bracer, shooting gloves, thong, bow, and shaft. The bracer was to save the arm of the bowman "from the stryge of stryng, and his doublet from wearyng;" and also that "the stryng glydyng sharpely and quickley off the bracer, may make the sharper shoote. For if the stryng should lyte upon the bare sleve, the strengthe of the shoote should stoppe and dye there." (*The Schole of Shootyng*, 2d booke, p. 3., edit. 1544.) The shooting glove was to save the "manne's fyngers from hurtyng" when he drew the string, and it had a purse attached to put some fine linen and some wax in. The string Ascham advises to be made of bullock's entrails, or therms, as they were called, twined together like ropes, to give "a greater twang." He then enumerates the different kinds of wood of which bows may be made (see p. 2070.), but gives the preference decidedly to the yew. The next division is headed "Ewe fit for a bowe to be made on," in which he informs us that "every bowe is made of the bough, the plante, or the boole, of the tree. The bough is knotty and full of prunes; the plante is quicke enough of caste," but is apt to break; and "the boole" is the best. He adds, "If you come into a shoppe and fynde a bowe that is small, longe, heavey, stronge, lyinge streighte not wyndyng, not marred with knotte, gaule, wyndshake, wem, freat, or pinch, bye that bowe of my warrant. . . . The beste colour of a bowe is when the backe and the bellye in workyng be much what after one maner; for such oftentimes prove like virgin

waxe or golde, having a fine longe grayne even from one end of the bowe to the other; the short grayne, although such prove well sometimes, are for the most parte brittle." (p. 6.) "Of the makinge of the bowe" he continues, "I wyll not greatly meddle, leste I shoulde seeme to enter in another manne's occupation, whych I can no skill of." Though Ascham does not enter into particulars respecting the making of the bow, it is clear, from other authors, that in his time it consisted of a single piece of wood, commonly yew, from 4 ft. to 6 ft. long, without any felt wrapped round the middle of it to stay the hand, as is done at present. There were, however, two pieces of horn, one at each end, to retain the string, which resembled those now in use. The string was made of the sinews or entrails of animals; and the shaft or arrow of a light and yet strong wood, headed with iron, and trimmed with feathers. (See *Oldfield's Anecdotes of Archery*, p. 20.) The best wood for the arrows is ash, and the next best birch or hornbeam. Willow is too light, and is apt to make a quavering uncertain flight; as are arrows of deal, and also of the different kinds of poplar, except the aspen and the abele. There are twenty-four arrows in a sheaf or quiver. The manufacturers of bows were called bowyers, and the arrow-makers fletchers. These trades, with the stringers and arrow-head makers, petitioned Queen Elizabeth in 1570, to enforce in their favour a statute of Henry VIII., enjoining every man to have a bow in his house. She did so, and butts were erected in different places, such as Newington Butts, &c., at which every able-bodied man was enjoined to practise the art. Foreign yew, however, began to grow scarce; and it was thought so superior to English yew, that a bow of it sold for 6s. 8d., when the bow of English yew cost only 2s. The Venetians, who were the chief importers, having exhausted the stock in Italy and Turkey, procured yew staves from Spain; till at last the Spanish government disliking the trade, ordered all their yew trees to be cut down. When yew could no longer be obtained of sufficient size to make an entire bow, it struck a bowyer of Manchester of the name of Kelsal, about the end of the 16th century, that he might make the back of the bow of another kind of wood, retaining the belly of yew. Ash, elm, and several other woods, were used for this purpose; and at last backed bows became so common as almost to supersede the use of self bows, as those were called, which were made of a single piece. Sometimes they were made of three, and sometimes even of four pieces of wood; but the best are of two. Gradually also yew came to be disused; and ornamental foreign woods, particularly fustick, lancewood, and partridge-wood were employed. For the best account of archery, and every thing relating to bows, up to the commencement of the present century, we may refer to Roberts's *English Bowman, or Tracts on Archery*, published in 1801; and for able historical researches on the subject, to Moseley's *Essay on Archery*, and Grose's *Treatise on Ancient Arms and Armour*. Mr. Waring, the first bow-manufacturer in England, and perhaps in Europe, informs us that the common yew with sufficiently clear and knobless trunks is no longer to be found, either in England, or in any other part of Europe; and though English yew is occasionally used by manufacturers, yet that bows are now almost entirely made of different kinds of wood from South America. He showed us, indeed, one or two bows, in which the belly was made of English yew, and the back of hickory, but these he considered of a very inferior description. Perhaps if yew trees were planted in masses, and drawn up to the height of 10 ft., with clear trunks, and cut down when they were of 6 in. or 8 in., in diameter, they might still be used for this manufacture.

The fruit of the yew is applied to no use in Britain, though the kernel of the nut may be eaten; and it is said to afford, by expression, an oil which is good for fattening poultry. The dried leaves have been given to children for killing worms; but it is a dangerous medicine, and has often proved fatal. An infusion of the leaves is said to be used, in some parts of Hampshire, for sponging the bodies of the dead, under the idea of its retarding putrefaction. Mr. Knight, finding that wasps prefer the fruit of the yew to that

of the vine, suggests the idea of planting female yew trees near vineries. (*Hort. Trans.*)

The yew makes excellent hedges for shelter; undergrowth for the protection of game; and, when planted thick on suitable soil, so as to be drawn up with clean and straight trunks, most valuable timber. When the hedge is wanted to be of one shade of green, the plants should all be raised from cuttings of the same tree; and, when they are intended to show fruit, in order to rival a holly hedge, only female plants should be chosen; and the hedge, like holly hedges kept for their fruit, should be cut in with a knife, and never clipped with the shears. Single scattered trees, when intended to be ornamental by their berries, should, of course, always be females; and, in order to determine their sex, they should not be removed to where they are finally to remain till they have flowered. This may, doubtless, be accelerated by ringing a branch on each plant after it has attained 5 or 6 years' growth.

The use of the yew tree in ancient topiary gardening, during the seventeenth century, was as extensive, in England and France, as that of the box seems to have been in Italy in the days of Pliny. The practice was rendered fashionable by Evelyn, previously to which the clipping of trees as garden ornaments was chiefly confined to plants of box, juniper, &c., kept by the commercial gardeners of the day in pots and boxes, and trained for a number of years, till the figure required was complete. Sometimes, as we find by Gibson, Bradley, and others, clipped plants of this sort sold as high as five guineas each; and, in all probability, this high price first led Evelyn to the idea of clipping the more hardy yew in situations where it was finally to remain. The narrowness of the leaves of the yew renders it far less disfigured by clipping than even the box; and, as it is much harder than the juniper, should clipped trees come again into fashion, there can be no doubt that the yew would be preferred to all others. As an avenue tree, the yew may be considered suitable for approaches to cemeteries, mausoleums, or tombs; and, as a single tree, for scattering in churchyards and burial-grounds.

In modern gardening, the yew is chiefly valued as undergrowth, and for single trees and small groups in particular situations. "As to its picturesque perfections," says Gilpin, writing in 1780, "I profess myself (contrary, I suppose, to general opinion) a great admirer of its form and foliage. The yew is, of all other trees, the most tonsile. Hence all the indignities it suffers. We every where see it cut and metamorphosed into such a variety of deformities, that we are hardly brought to conceive it has a natural shape, or the power which other trees have of hanging carelessly and negligently. Yet it has this power in a very eminent degree; and, in a state of nature, except in exposed situations, is, perhaps, one of the most beautiful evergreens we have. Indeed, I know not whether, all things considered, it is not superior to the cedar of Lebanon itself: I mean, to such meagre representations of that noble plant as we have in England. The same soil which cramps the cedar is congenial to the yew. It is but seldom, however, that we see the yew in perfection. In the New Forest it formerly abounded, but is now much scarcer. But still, in many parts of the New Forest, some noble specimens of this tree are left. One I have often visited, which is a tree of peculiar beauty. It immediately divides into several massive limbs, each of which, hanging in grand loose foliage, spreads over a large compass of ground; and yet the whole tree forms a close compact body; that is, its boughs are not so separated as to break into distinct parts. But, though we should be able to establish the beauty of the yew with respect to form and foliage, there remains one point still which we should find it hard to combat. Its colour, unfortunately, gives offence. Its dingy funereal hue, people say, makes it only fit for a churchyard. An attachment to colour, as such, seems to me an indication of false taste. Hence arise the numerous absurdities of gaudy decoration. In the same manner, a dislike to any particular colour shows a squeamishness, which should as little be encouraged. Indeed, when you have only one colour to deal with, as in painting the wainscot of your room, the eye;

properly enough, gives a preference to some soft pleasant tint, in opposition to a glaring bold one; but, when colours act in concert (as is the case in all scenery), red, blue, yellow, light green, or dingy green, are all alike: the virtue of each consists solely in its agreement with its neighbours." (*For. Scen.*, i. p. 101.)

The poisonous Nature of the Yew Tree has been known (as we have seen in p. 2069.) since the time of Theophrastus, though some are of opinion that the yew of the ancients was a species of cypress. A mass of evidence, however, proves that the yew of the moderns is generally poisonous in its branches and leaves, though the berries may be eaten with perfect safety. The leaves were formerly thought a cure for worms in children; but Dr. Percival of Manchester, in his *Medical and Philosophical Essays*, relates a melancholy circumstance of three children being poisoned by their mother's giving them yew leaves for this purpose. The children first took a spoonful of the dried leaves, equally divided among them, and mixed with brown sugar, and afterwards ate a mess of porridge with sour buttermilk. From this dose they experienced no bad effect: but, two days afterwards, the mother, finding the worms still troubled them, administered a dose of the fresh leaves, giving them afterwards a mess of nettle pottage; that is, gruel with young nettles boiled in it; and in a few hours the children were all dead. They appeared to have suffered no pain, and, after death, looked as though they were in a placid sleep. A young lady and her servant, in Sussex, who had drunk a decoction of yew leaves by mistake for rue, died in the same manner; and several other instances are related of their proving fatal to human beings. There are instances of horses and cows having been poisoned by eating the branches of the yew; and sheep have been killed by browsing upon the bark of the tree; but goats, deer, and turkeys are said to eat the leaves without being injured by them. In the *New Planter's Calendar*, it is stated, that, though the yew has been cried down as a standard in pasture ground, on account of the poisonous nature of the leaves, yet there are many yew trees in pastures, not fenced round, and also hedges, which are uniformly browsed by sheep and cattle without doing them any injury whatever. Hanbury relates a story of seven or eight cattle "having died in consequence of having eaten the half-dried clippings of a yew tree or hedge, which the gardener had thrown over the wall; by which it would appear that the leaves and twigs, when dried or half-dried, and when taken into the stomach in considerable quantities, have a very different effect from what they have when taken in small quantities when green." Marshall has seen extensive yew plantations, into which cattle were admitted without any evil consequence to themselves, though the trees were browsed to the very bough. Sheep, he says, are particularly fond of the leaves, and, when the ground is covered with snow, will stand upon their hind legs, and devour them as high as they can reach.

In the *Dictionnaire des Eaux et Forêts*, the subject of the poisonous nature of the yew is discussed at great length. The young shoots, it is allowed, are poisonous both to men and animals, acting like other acrid poisons, by producing inflammation and spasms; the antidotes to which are oily substances. In 1753, several horses having entered into a garden near Bois le Duc, in Dutch Brabant, ate some of the branches of this tree, and died four hours afterwards, without any other symptoms than spasms, which continued for several minutes. A similar instance is related by Varennes de Fenilles respecting a company of cavalry horses, during the war in Germany, which had been tied to some yews, and had eaten of them. Valmont de Bouare mentions that an ass, which had been fastened to a hedge of yews near the Jardin des Plantes, after eating a few of the branches, instantly expired, being greatly inflated. MM. Daubenton and Desfontaines have seen poultry and sheep, that had eaten of the leaves of the yew tree, die in a short time. These pernicious effects of the yew have been confirmed by the repeated experience of Professor Wiborg, in the Veterinary School, and at the Botanic Garden, of Copenhagen. From the experiments of the professor, it appears that yew

leaves, eaten alone, are fatal to animals, particularly to horses, upon which he made his experiments; but that, when mixed with twice or thrice as much oats, they may be used without any danger. This neutralisation of the poisonous qualities of the yew by another vegetable may explain, to a certain extent, the diversity of opinion upon their effects; it being possible that some animals, which have eaten of the yew without inconvenience, had shortly before eaten heartily of some other vegetable. At all events, as M. Dutour observes, it is possible that the nature of the soil, the climate, and the age of the tree, may contribute to diminish its bad effects; and it is certain, that with this poison, as with certain others (opium for example), custom renders it innoxious. It is said that, in the mountains of Hanover and Hesse, the peasants feed their cattle in part with the branches of the yew, during the winter. They know its poisonous qualities; and, although they reckon it good food, they are aware that great precaution is necessary in using it, without which they run the risk of losing their cattle: consequently, they give them at first a very little, mixed with other forage; afterwards they gradually augment the quantity, until at last they can almost give them the leaves of alone, without any danger.

Soil, Propagation, &c. The yew will grow on any soil that is somewhat moist; but it thrives best in loams and clays, on rock, and in a shady situation. It is propagated for the most part by seeds; but the varieties, and also the species, when the object is to form a hedge of plants of the same dimensions and colour of leaf, as already mentioned (p. 2088.), should be propagated by cuttings or layers from one plant only. The berries are ripe in October, and should be then gathered, carried to the rot-heap, and treated in the same manner as haws. (See p. 840.) If, however, they are sown immediately, enveloped in their pulp, a few of them may come up the following year, and the remainder the second year; but, if the pulp is allowed to dry round the nut, and they are kept in that state till spring, none of them will come up till the third year. Cuttings may be formed of either one or two years' growth, and planted in a shady border, either in the beginning of April or the end of August. The cuttings will be most certain of success if slipped off with a heel, and if the soil consists chiefly of sand. The leaves should be carefully stripped off the lower part of the cutting, which may be from 7 in. to 10 in. in length, and buried to the depth of 5 in. in the soil. Cuttings treated in this manner require two years before they are sufficiently rooted to be removed. In all probability, however, if the points of the shoots were taken and planted in sand under a hand-glass, about midsummer, or before, they would produce roots the same season, and might be transplanted the following spring. Whether plants are raised from seeds or cuttings, they ought to undergo the usual routine of culture in the nursery, till they are 3 ft. or 4 ft. high; because, as they are of slow growth, time is gained by this practice; and the yew transplants so readily at any age, that there is no more danger of plants falling when transplanted at the height of 6 ft. or 8 ft., than there is when they are only 6 in. or 8 in. high. In planting the yew for hedges, the advantage of having large-sized plants is obvious; for which reason Boucher recommends them to be kept in the nursery till they are 7 or 8 years of age, at which time they will be 7 ft. or 8 ft. high. The season for transplanting the yew, whether of a large or small size, is, as in the case of all other ever-greens, when the sap is in a comparatively dormant state, between autumn and spring, and when the weather is open, mild, and, if possible, showery. If transplanted in frosty weather, or while a dry wind prevails, they ought to be covered with mats or straw, or wicker hurdles, kept 6 in. or 8 in. from the plant by stakes and poles. The proper season for clipping yew hedges is towards the end of June, when the shoots of the year have been completed; and, to retain a hedge in the greatest beauty or verdure for the greatest length of time, it ought to be gone over in the latter end of July, or the beginning of August; and the points of all those shoots which had become stubby, from repeated clippings, cut back 3 in. or 4 in. If this be not attended to annually,

the entire surface of the hedge will have to be cut in to the same depth every 5 or 6 years, otherwise the surface will become so thick and matted with twigs as to exclude the air from the interior, and to kill a number of the branches, so as here and there to form gaps. These gaps, by admitting the air, are the means of keeping the hedge alive; and it is curious in this way to see nature relieving herself.

The yew is admirably adapted for underwood; because, like the holly and the box, it thrives under the shade and drip of other trees. When planted in masses by itself, the trees are drawn up with straight trunks, like pines and firs; and, in good loamy soil, on a cool bottom, plantations of yews, treated in this manner, must evidently be highly valuable. There are some fine yew groves, with tall clean trunks, at Combermere, in Cheshire; and here and there in plantations, in most parts of the country, proofs may be obtained that the yew, like the cedar of Lebanon, the red cedar, the arbor vitæ, the juniper, and various other trees, usually seen as immense bushes, might easily be grown so as to throw all their strength into a clean straight trunk.

Accidents, Diseases, &c. The wood of the yew is tough, and therefore not liable to be injured by storms; and both the wood and the leaves being poisonous, neither are attacked by insects; or if they are, it is in a very slight degree. The points of the shoots, in some situations and seasons, produce little tufts of leaves, which may be considered as abortive shoots. Very few lichens or fungi are ever found on the bark; because that, as we have already observed, scales off every year. *Sphæria Taxì Sow.*, t. 494. f. 6., is common on the branchlets and leaves.

Statistics. Recorded Trees. The list of these might be greatly extended; but we shall confine ourselves to a few, commencing with one mentioned by Evelyn as growing in the churchyard of Crowhurst, in Surrey, with a trunk 10 ft. in diameter. The same author also mentions "a superannuated yew tree, growing in Eraburce churchyard, in Kent, with a trunk 8 ft. 11 in. in circumference, which had been blown down, and sawn up into goodly planks, and considerable pieces of square and clear timber. Such another monster," he says, "is to be seen in Sutton churchyard, near Winchester." (*Hunt. Eccl.*, vol. ii. p. 195.) Box Hill, in Surrey, was, in the time of Evelyn, as celebrated for its yews as for its box trees. A tree at Hadsor, in Bucks, near the church, is said to have measured 9 ft. in diameter; but this tree no longer exists. White mentions a yew tree in the churchyard of Selborne, which, in 1789, was apparently of great age. The body was squat, short, and thick, and girted 23 ft., supporting a large head. It was a male tree; and, in the spring, it shed clouds of dust. Most of the yew trees in the churchyards of that neighbourhood, he says, are males; which, White thinks, must be matter of mere accident, since, when these trees were planted, it was not generally known that there were sexes in trees; but, since he allows that the male trees are of more robust growth than the females, by selecting the strongest plants from seed-beds in which the plants stood all at equal distances, the chance would be in favour of males. A tree at Little Shardon, near Sharneshill, in Staffordshire, had, in 1780, a singularly picturesque appearance, and formed one of a vast number of very old and large yew trees. (See *Genl. Mag.*, vol. ix. p. 1187, Supp., where a figure of this picturesque tree is given.) In Scotland, according to Dr. Walker, there were a great many yew trees in the latter end of the last century, with trunks varying from 6 ft. to 52 ft. in circumference; the latter being the dimensions of the Fortingal Yew. On the hills between Dumbarton and Loch Lomond, there were, in the beginning of the present century, many hundreds of large yew trees, all of which have been cut down and sold. Hayes, in 1794, records several trees as at that time existing in Ireland. At Dunganstone, he saw above 30 trees, most of them with clear trunks 2 ft. in diameter, and upwards of 30 ft. high. A yew tree at Fornace, in Kildare, the same author observes, has a trunk 4 ft. in diameter at 8 ft. from the ground; and the diameter of the head is 36 ft.

Existing Trees. In the environs of London. There are many yew trees at Syon, and at the Chiswick villa, between 30 ft. and 50 ft. in height; at Mount Grove, Hampstead, a tree, 18 years planted, is 16 ft. high; at York House, Twickenham, 100 years old, it is 50 ft. high.—South of London. In Devonshire, in the churchyard of Stoke-Gabriel, situated on the river Dart, is a fine old yew, 40 ft. high, the trunk of which is 13 ft. 8 in. in circumference, and the diameter of the head is 70 ft.; at about 7 ft. from the ground, the trunk divides into two limbs, one of 5 ft. 6 in., and the other 4 ft. 6 in., in circumference. In Dorsetshire, at Melbury Park, 200 years old, it is 55 ft. high, the diameter of the trunk 3 ft., and that of the head 51 ft. In the Isle of Jersey, in Saunders's Nursery, 10 years planted, it is 9 ft. high. In Somersetshire, at Brockley Hall, it is 30 ft. high, with a trunk 18 ft. in circumference; another, with a trunk 17 ft. in circumference: at Leigh Court, it is 45 ft. high, the circumference of the trunk 11 ft., and the diameter of the head 48 ft. In Surrey, at Titsey Place, near Godstone, it is 48 ft. high, the circumference of the trunk, at 5 ft. from the ground, is 18 ft. 6 in., and the diameter of the head between 60 ft. and 70 ft. In Hone's *Every Day Book* is an engraving of a yew tree in Windlesham churchyard, near Bagshot, Surrey, said to have been planted in the time of William the Conqueror, 21 ft. high, and 12 ft. in girth. In Sussex, at Cowdray, it is 30 ft. high, with a trunk of 4 ft. in diameter; at Kidbrooke, it is 40 ft. high, the diameter of the trunk 3 ft. 6 in., and of the head 54 ft. In Wiltshire, at Longleat, 300 years old, it is 36 ft. high, the diameter of the trunk 10 ft. 4 in., and that of the head 42 ft.—North of London. In Berkshire, at Aldsworth, near Wallingford, in the churchyard, is one 27 ft. 3 in. in circumference at 5 ft. from the ground; it has a fine regular head, urn-shaped, though, compared with the trunk, it is a dwarf. At Hampstead Marshall, there are the remains of a very old yew, the trunk of which was 47 ft. in circumference a few years ago; but which, in 1836, was only 37 ft. in circumference. In Cheshire, at Tashley Hall, 70 years old, it is 30 ft. high, the diameter of the trunk 1 ft., and of the head 96 ft. In Denbighshire, at Llanbede Hall, 35 ft. high, the diameter of the trunk 3 ft., and that of the head 41 ft. In Durham, at Southend, 23 years planted, it is 20 ft. high, the diameter of the trunk 1 ft., and that of the head

30 ft. In Essex, at Shortgrove, there is a tree 50 ft. high, with a trunk 5 ft. 3 in. in diameter, and the diameter of the head 55 ft.; at Braybrooke, 51 years planted, it is 25 ft. high, the diameter of the trunk 1 ft. 6 in., and of the head 27 ft.; at Hyland, 10 years planted, it is 14 ft. high, the circumference of the trunk 1 ft. 10 in., and the diameter of the head 13 ft. In Hampshire, in Warlington churchyard, near Portsmouth, it is 26 ft. in circumference. In Kent, in Leeds churchyard, is a yew tree, the greatest circumference of which was 31 ft. 2 in.; at 7 ft. high, 28 ft. 8 in.; diameter of the hollow, in October, 1833, when some gipsies had been residing in it, 8 ft. 6 in.; height to the lowest branch 7 ft. 11 in.; total height 32 ft. 4 in.; and diameter of the head 50 ft. In Leicestershire, at Donnington Park, 25 years planted, it is 31 ft. high, the diameter of the trunk 10 in., and of the head 24 ft. In Northamptonshire, in the churchyard at Ashby, is a very large yew tree; but it is not easy to take its dimensions, as the stem is buried in mould up to the branching off of its chief branches. In Northumberland, at Hartburn, 80 years old, it is 38 ft. high, the diameter of the trunk 5 ft. 6 in., and that of the head 30 ft. In Oxfordshire, in the Oxford Botanic Garden, 200 years old, it is 36 ft. high, the diameter of the trunk 2 ft., and of the head 24 ft.; a female tree; another, a male tree, 200 years old, is 38 ft. high, the diameter of the trunk 1 ft. 9 in., and of the head 27 ft. The yew hedges which formerly existed in this garden have been already mentioned, p. 2076. In Pembrokeshire, at Stackpole Court, 20 years planted, it is 20 ft. high, the diameter of the trunk 9 in., and that of the head 18 ft. In Radnorshire, at Maelough Castle, 26 ft. high, the diameter of the trunk 3 ft. 9 in., and that of the head 65 ft. In Shropshire, at Hardwicke Grange, 9 years planted, it is 13 ft. high; at Willey Park, 21 years planted, it is 21 ft. high, the diameter of the trunk 1 ft., and of the head 18 ft.; at Kinlet, 40 ft. high, the diameter of the trunk 5 ft., and that of the head 71 ft. In Staffordshire, at Himley Hall, are several immense yew trees, particularly one which is celebrated for its widely spreading head. In Suffolk, at Finborough Hall, 70 years planted, it is 50 ft. high, the diameter of the trunk 2 ft. 2 in., and that of the head 45 ft. In Worcestershire, at Hadsor House, it is 40 ft. high, and has a trunk 7 ft. in circumference; at Croome, 40 years old, it is 30 ft. high, the diameter of the trunk 1 ft. 6 in., and that of the head 20 ft.; in Backleton churchyard is a very fine tree, with a trunk 7 ft. in diameter at 4 ft. from the ground. In Yorkshire, at Grimston, 13 years planted, it is 14 ft. high, the diameter of the trunk 9 in., and of the head 14 ft.; at Spotborough Hall, near Doncaster, it is 34 ft. high, circumference of the trunk, at 3 ft. from the ground, 15 ft. 6 in., diameter of the head 63 ft.; in Studley Park, 50 ft. 6 in. high, with a trunk 4 ft. 9 in. in diameter, and the diameter of the head 56 ft. (See fig. 1991.)—In Scotland, in the environs of Edinburgh, at Gosford House, 35 years planted, it is 20 ft. high, diameter of the trunk 3 ft. 10 in., and of the head 21 ft.; at Hatton House it is 40 ft. high, the diameter of the trunk 2 ft., and of the head 30 ft.; at Moreduin, 40 ft. high, the diameter of the trunk 3 ft. 4 in., and of the head 57 ft.—South of Edinburgh. In Berwickshire, at the Hirsel, 30 years planted, it is 17 ft. high, the diameter of the head 25 ft. In Kircudbrightshire, at St. Mary's Isle, it is 30 ft. high, the diameter of the trunk 2 ft. 3 in., and that of the head 38 ft. In Haddingtonshire, at Tynningham, it is 24 ft. high, the diameter of the trunk 2 ft. 9 in., and of the head 57 ft. In Roxburghshire, at Dryburgh Abbey, the one already noticed, p. 2079; and at Minto, 140 years old, it is 20 ft. high, the diameter of the trunk 2 ft., and of the head 54 ft.—North of Edinburgh. In Argyllshire, at Minard, is a beautiful tree, about 130 years old, 34 ft. 6 in. high, diameter of the head 59 ft. In Banffshire, at Huntley Lodge, it is 33 ft. high, the diameter of the trunk 1 ft. 8 in. In Clackmannanshire, in the garden of the Dollar Institution, 10 years planted, it is 10 ft. high. In Cromarty, at Coul, 200 years old, it is 22 ft. high, the diameter of the trunk 2 ft. 6 in., and that of the head 39 ft. In Forfarshire, at Monboddio, 100 years old, it is 20 ft. high, the diameter of the trunk 1 ft. 6 in., and of the head 30 ft.; at Kinnaird Castle, 35 years old, it is 30 ft. high, the circumference of the trunk 5 ft., and the diameter of the head 35 ft. In Perthshire, on the estate of ——— Johnstone, Esq., near the Old Castle of Kincardine, 700 years old, it is 45 ft. high, with a trunk 13 ft. 6 in. in circumference, and with three large limbs, one of which is 19 ft. long, and 7 ft. in girth; a second, 28 ft. long, and 5 ft. in girth; and a third, 22 ft. long, and 5 ft. 6 in. in girth: at Tarmouth, 100 years old, it is 40 ft. high, the diameter of the trunk 2 ft., and of the head 36 ft.; at Marlee, near Dunkeld, a male and a female tree, standing close together, of very large dimensions, and in a vigorous state of growth. In Ross-shire, at Brahan Castle, 50 ft. high, the diameter of the trunk 14 in., and of the head 30 ft. In Scirringshire, at Callender Park, 22 ft. high, the circumference of the trunk 11 ft., and the diameter of the head 33 ft.; at West Plean, 10 years planted, it is 8 ft. high.—In Ireland, near Dublin, at Tereure, 15 years planted, it is 12 ft. high; var. *fastigiata*, 20 years planted, is 15 ft. high.—South of Dublin. In Cork, at Morn Park, 33 ft. high, the diameter of the trunk 2 ft. 4 in., and that of the head 47 ft. In King's County, at Charleville Forest, 45 years planted, it is 50 ft. high, the diameter of the trunk 2 ft., and of the head 45 ft.—North of Dublin. In Down, at Castle Woods, 134 years old, it is 35 ft. high, the diameter of the trunk 2 ft. 8 in., and of the head 39 ft.; at Moira, 45 ft. high, the diameter of the trunk 4 ft., and that of the head 39 ft. In Fermanagh, at Florence Court, 89 years old, it is 33 ft. high, the diameter of the trunk 3 ft., and of the head 30 ft.: var. *fastigiata* is a native of the neighbouring mountains, where the original plant is still in being. In Galway, at Coole, 30 ft. high, the diameter of the trunk 3 ft., and of the head 21 ft. In Sligo, at Makree Castle, 52 ft. high, the diameter of the trunk 3 ft., and that of the space covered by the branches 39 ft.—In France, in the Jardin des Plantes, 120 years old, it is 45 ft. high, the diameter of the trunk 5 ft.; in the same gardens, 50 years old, it is 20 ft. high. Near Nantes, 60 years old, it is 30 ft. high. At Avranches, in the Botanic Garden, 40 years planted, it is 20 ft. high, the diameter of the trunk 1 ft., and that of the head 20 ft.—In Hanover, in the Botanic Garden at Göttingen, 30 years planted, it is 20 ft. high.—In Cassel, at Wilhelmshoe, 30 years old, it has a trunk 1 ft. in diameter.—In Bavaria, at Munich, in the Botanic Garden, 19 years old, it is 8 ft. high.—In Austria at Vienna, in the University Botanic Garden, 30 years old, it is 20 ft. high, the diameter of the trunk 9 in., and of the head 18 ft.; at Laxenburg, 28 years planted, it is 16 ft. high; in Rosenthal's Nursery, 17 years planted, it is 13 ft. high; at Brück on the Leytha, 40 years planted, it is 15 ft. high.—In Berlin, at Sans Souci, from 45 to 50 years old, it is 26 ft. high; the diameter of the trunk 11 in., and of the head 9 ft.—In Sweden, at Lund, in the Botanic Garden, it is 28 ft. high, the diameter of the trunk 9 in., and of the head 10 ft.—In Italy, in Lombardy, at Monza, it is 30 years old, and 36 ft. high; the diameter of the trunk 6 in., and of the head 20 ft.

Commercial Statistics. Transplanted seedlings, in the London nurseries, 1 ft. high, are 1*s.* per hundred; 2 ft. high, 40*s.* per hundred; and plants of *T. b. fastigiata*, 1*s.* 6*d.* each. At Bollwyller, plants of the common yew are 1 franc each, and those of the variegated-leaved variety, and of the common yew, 5 francs each. At New York, small plants of the common yew are from 25 to 50 cents each; large plants, 1*½* dollar each; and plants of the Irish yew are 1 dollar each.



2. *T. (B.) CANADENSIS* Willd. The Canada, or North American, Yew.

Identification. Willd. Sp. Pl., 4. p. 856; Pursh Fl. Amer. Sept., 2. p. 667.; Smith in Rees's Cycl., No. 2.

Synonymy. *T. b. minor* Mich. Bor. Amer., 2. p. 245.

Spec. Char., &c. Leaves linear, 2-ranked, crowded, revolute. Male flowers globose, always solitary. (*Smith.*) Michaux describes this species as of humbler growth than the European yew, of spreading habit, and with smaller flowers and fruit; and Pursh says that, under the shade of other trees, it does not rise above 2 ft. or 3 ft. high. Willdenow says that it is smaller and narrower in all its parts, and that it does not alter by culture; yet that a specific difference is hard to be detected. The leaves, however, are narrower, smaller, and revolute at the margin; and the male flowers are always solitary in the bosoms of the leaves. It is a native of North America, in Canada, and on the banks of the Anticem, in Maryland; growing only in shady rocky places, and flowering in March and April. It was introduced in 1800; and there are plants of it in the Horticultural Society's Garden, and in various nurseries; but it is obviously only a variety of the common yew.

GENUS II.

**SALISBURIA** Smith. **THE SALISBURIA.** *Lin. Syst. Monœcia Polyandria.*

Identification. *Lin. Trans.*, 3. p. 330.; *Willd. Sp. Pl.*, 4. p. 472.; *Horn. Hort. Reg. Haff.*, 2. p. 903.
Synonymæ. *Ginkgo* of Kämpfer, Linnæus, and others.

Derivation. Named in honour of *R. A. Salisbury*, F.R.S., L.S., &c., a distinguished botanist. *Ginkgo* is the aboriginal name in Japan.

Description, &c. A deciduous tree of the first magnitude, a native of Japan, and remarkable for the singularity of its leaves, which seem to unite Coniferæ with the *Corylæcæ*.

‡ 1. *S. ADIANTIFOLIA* Smith. **The Maiden-hair-leaved Salisburia,**
or Ginkgo Tree.

Identification. *Trans. Lin. Soc.*, 3. p. 330.; *Willd. Sp. Pl.*, 4. p. 472.; *Horn. Hort. Reg. Haff.*, 2. p. 903.; *Jacq. Ueber den Ginkgo.*
Synonymæ. *Ginkgo*, *Gin-ssu*, or *Itojo*, *Kämpf. Amoen.*, p. 811.; *Ginkgo biloba* *Lin. Mant.*, p. 313., *Syst. Veg.*, ed. 14., p. 987.; *Thunb. Fl. Jap.*, p. 358.; *Ferr. Synop.*, 2. p. 573.; *Tratt. Arb. Tor.*, ed. 2., 2. p. 80.; *Dec. in Bibl. Univ.*, 7. p. 130.; *Presch in Bibl. Univ.*, 7. p. 29.; *Gouan Descr. du Ginkgo*, &c.; *Noyer du Japon, Arbre aux quarante Ecus.*

The Scæzæ. Both sexes are in the *Kew Botanic Garden*, in the *Hackney Arboretum*, and in our garden at *Bayswater*.

Engravings. *Kämpf. Amoen.*, p. 811. f.; *Gouan Descr. du Ginkgo*, &c. f.; *Jacquin Ueber den Ginkgo*, t. 1.; our *Agæ.* 1962. and 1963.; and the plates of this tree in our last *Volume*.

Description, &c. In its native country, the salisburia forms a large tree, like the walnut, but is more conical in its manner of growth. In England, in the climate of London, where it is in a favourable soil and situation, it rises with a straight erect trunk, regularly furnished with alternate branches, at first inclined upwards, but, as they become older, taking a more horizontal direction, so as to form a regular, conical, and somewhat spiry-topped head. The bark is grey, somewhat rough, and it is said to be full of fissures when the tree gets to be old. The leaves resemble those of the *Adiantum vulgare*. They are of the same colour and texture on both sides, and resemble, in their smoothness and parallel lines, those of a monocotyledonous plant. They are somewhat triangular in shape, disposed alternately, like the branches; wedge-shaped at the base, with stalks as long as the disk: they are abrupt at the upper extremity, and cloven or notched there, in a manner almost peculiar to this genus, and to some species of ferns: they are smooth, shining, and pliant, of a fine yellowish green, with numerous minute parallel ribs; and their margins are somewhat thickened. The male catkins, which appear with the leaves, in May, on the wood of the preceding year, or on old spurs, are sessile, about $1\frac{1}{2}$ in. long, and of a yellowish colour. The female flowers, according to Richard, have this particularity, that each is in part enclosed in a sort of cup, like the female flowers of *Dacrydium*. This covering is supposed to be produced by a dilatation of the summit of the peduncle, as may be seen in our figure. The fruit consists of a globular or ovate drupe, about 1 in. in diameter; containing a white nut, or endocarp, somewhat flattened, of a woody tissue, thin, and breaking easily. The nut, when examined by Sir J. E. Smith, from specimens in his possession, which were sent from China to Mr. Ellis, was found to be larger than that of the pistachia, with a farinaceous kernel, having the flavour of an almond, but with some degree of austerity. The tree grows with considerable rapidity in the climate of London, attaining the height of 10 ft. or 12 ft. in 10 years; and in 40 or 50 years, the height of as many feet. The longevity of the salisburia promises to be great, for the largest trees in England, that are in good soils, continue to grow with as much vigour as when they were newly planted; and the tree at *Utrecht*, which is supposed to be between 90 and 100 years of age, and, consequently, the oldest in Europe, though not large, still produces vigorous shoots. The highest tree that we know of in England is at *Purser's Cross*, where it was planted about 1767, as we have



seen in p. 72. ; and it is above 60 ft. high : but by far the handsomest tree which we know of is that figured in our last Volume, from the Mile End Nursery ; which, remeasured in July, 1837, was found to be exactly 60 ft. high.

Geography and History. The salisburia, or ginkgo tree, is generally considered by botanists to be a native of the Island of Nippon, and other parts of Japan, and also of China ; but M. Siebold, who resided seven years in Japan, and is publishing the flora of that country, states that the inhabitants of Japan consider the tree as not truly indigenous to their country, but to have been brought to them from China, though at a very remote period ; and Bunge, who accompanied the mission from Russia to Pekin, states that he saw near a pagoda, an immense ginkgo tree, with a trunk nearly 40 ft. in circumference, of prodigious height, and still in the vigour of vegetation. (*Bull. de la Soc. d'Ag. du Départ. de l'Hérault*, 1833.)

It was first discovered by Kæmpfer in Japan, in 1690 ; and an account of it was published by that author, in his *Amœnitates Exoticæ*, in 1712. It is uncertain when this tree was introduced into Europe. If the estimate made by Professor Kops of Utrecht, as to the age of the salisburia growing in the Botanic Garden there, be at all near the truth, it must have been first introduced into Holland between 1727 and 1737 ; and, from the connexion of the Dutch with Japan at that time, we think this highly probable. It is certain that it was not introduced into England till 1754, or a year or two previous ; because Ellis, writing to Linnæus in that year, mentions that Gordon had plants of it. Gordon sent a plant of it to Linnæus in 1771 ; who, in his *Mantissa*, published in that year, noticed it, for the first time, under the name of *Ginkgo bifloba* ; which was altered by Smith, in 1796, to *Salisburia adiantifolia*. This alteration, stated by Smith to be made on account of the generic name being "equally uncouth and barbarous," was very properly objected to at the time, and has since been protested against by M. De Candolle, on the principle of checking the introduction of a multiplicity of names. We have, however, adopted the name of

1993



Salisbùria, as it is that by which the tree is most generally known in England. It was planted in Rouen in 1776, and taken to Paris in 1780; it was sent to Schönbrunn, by Messrs. Loddiges, in 1781; to North America, by Mr. Hamilton, in 1784; and to Montpellier, in 1788, by Broussonet, who received it from Sir Joseph Banks. The manner in which this tree was introduced into the gardens of Paris is curious, and was thus related by M. André Thouin, when delivering his annual *Cours d'Agriculture Pratique* in the Jardin des Plantes:—In 1780, a Parisian amateur, named Pétigny, made a voyage to London, in order to see the principal gardens; and among the number of those he visited was that of a commercial gardener, who possessed five young plants of *Ginkgo biloba*, which was still rare in England, and which the gardener pretended that he then alone possessed. These five plants were raised from nuts that he had received from Japan; and he set a high price on them. However, after an abundant *déjeûné*, and plenty of wine, he sold to M. Pétigny these young trees of *Ginkgo*, all growing in the same pot, for 25 guineas, which the Parisian amateur paid immediately, and lost no time in taking away his valuable acquisition. Next morning, the effects of the wine being dissipated, the English gardener sought out his customer, and offered him 25 guineas for one plant of the five he had sold the day before. This, however, was refused by M. Pétigny, who carried the plants to France; and, as each of the five had cost him about 120 francs, or 40 crowns (*quarante écus*), this was the origin of the name applied to this tree in France, of *arbre aux quarante écus*; and not because it was originally sold for 120 francs a plant. Almost all the ginkgo trees in France have been propagated from these five, imported from England by M. Pétigny. He gave one of them to the Jardin des Plantes, which was kept for many years in a pot, and preserved through the winter in the green-house, till 1792; when it was planted out by M. André Thouin, who gave the above relation in his lectures: but, as the situation was not altogether favourable to it, the plant was not much above 40 ft. in height in 1834, and had not then flowered. There is another ginkgo in the Jardin des Plantes, which was raised by layering from one of the four others imported by Pétigny. Though much later planted than the other, yet, being in a better situation, it is about the same size, though it also has not flowered. The first ginkgo which flowered in Europe appears to have been a male plant, at Kew, in 1795; and shortly after, Mr. Dillwyn informs us, a male plant flowered at Ham House, in Essex. In the Botanic Garden at Pisa, a tree, which had not been much more than 20 years planted, flowered in 1807; and, in 1812, one flowered in the Botanic Garden at Montpellier, and another in that of Rouen. Hitherto, only the male blossoms of the tree had been seen; and it was believed that the female did not exist in Europe. De Candolle, however, in 1814, discovered the female flowers on a tree at Bourdigny, near Geneva; and it was from these flowers that L. C. Richard was enabled to give the description and figure of the flowers, which will be found in his *Mémoires sur les Conifères*, published by his son, Achille Richard, in 1826. The fruit formed; but, there being no male tree near, it did not come to maturity. This tree, Professor De Candolle, in his account of it in the *Bibliothèque Universelle de Genève*, tom. vii. p. 138., conjectures to have been planted between 1767 and 1797; because, he says, the former proprietor of Bourdigny, M. Gausson de Chapeaurouge, a zealous amateur, who sent for many exotic seeds and trees from England, commenced his plantations in 1767, and continued them for 30 years afterwards. Fortunately, we are able to indicate the age of this tree, with an approach to certainty, through the voluntary assistance of our venerable correspondent, Mr. Blakie, who went from England to France and Switzerland, as a botanical collector, and resided for some time at Bourdigny in 1775, when he was collecting plants upon the Alps for Drs. Pitcairn and Fothergill of London. Mr. Blakie deposited the plants he collected in the garden of M. Gausson, till he could find an opportunity of sending them to England. "When I returned to France, in 1776," says Mr. Blakie, "I continued in correspondence with M. Gausson;

and, when employed in forming the gardens at Bagatelle and Monceau in 1783 (see *Encyc. of Gard.*, edit. 1835, p. 88.), I always sent to M. Gausson some of all the new plants I got; and these were numerous, as I was then forming a collection of trees and plants at Monceau for the late Duke of Orleans. The last packet of trees that I sent to M. Gausson was in 1790; and amongst them was a plant of *Ginkgo biloba*, which I had reared at Monceau. I have M. Gausson's letter, wherein he writes me, from Geneva, 'I have received a parcel of plants (29 species) by M. Merlin, for which I beg your acceptance of my sincere thanks,' &c.; dated Geneva, Dec. 11. 1790; and signed 'Gausson de Chapeaurouge.'" (*Blakie in Gard. Mag.*, vol. xii. p. 266.) Mr. Blakie, whose interesting communication on this subject will be found in the *Gardener's Magazine*, vol. xii. p. 266., was not, and, indeed, could not be, aware whether the plants brought by him from England, and propagated at Monceau, were male or female; but, as those originally introduced from Japan were raised from imported nuts, there can be very little doubt that both sexes exist in various parts of Britain, as well as of the Continent. After the discovery made by M. De Candolle of the female plant, cuttings were distributed by him, from the Botanic Garden at Geneva, to the different Botanic Gardens of Europe, and, among others, to that of Montpellier. The first sent perished; but, in 1830, M. Delille, director of the garden, received, through his colleague, M. Vialars, two cuttings from M. De Candolle, which he grafted on two young male stocks, and which produced vigorous shoots. From some of these shoots, in 1832, M. Delille covered a male tree, 50 ft. high, with grafts; and the year following the tree produced one imperfect fruit; which was followed in, 1835, by other perfect ones, from which young plants have been raised. We saw a female tree raised from one of the cuttings distributed by M. De Candolle, in the Botanic Garden at Strasburg, in 1828: there is another at Kew, raised from a cutting received there in 1818; and there are some young plants at Messrs. Loddiges's, raised from cuttings received by them from M. De Candolle, in 1835; we, also, possess one obtained from Kew, which we had grafted on the summit of a male tree in 1831. M. Loiseleur Deslongchamps, in his *Note Historique sur le Ginkgo* (*Annales de la Soc. Hort.*, tom. xv. p. 93.), expresses regret, that neither the directors of the Jardin des Plantes, nor the proprietors of any of the private gardens of Paris, have, as far as he knows, availed themselves of the opportunity of obtaining plants of the female salisburia; and we may make the same remark with reference to the Horticultural Society's Garden, and all the London nurserymen except Messrs. Loddiges. He ingeniously conjectures, however, that some of the large trees in France, that have not yet shown flowers, may be females; because many males, not quite so large as they are, have flowered; and because it is well known that, in dioecious trees generally, the females are some years later in producing their blossoms than the males. In Great Britain, the ginkgo, or, as it is here called, the salisburia, has been most extensively propagated and distributed; but chiefly from the stool in the Mile End Nursery, which we know with certainty to be a male plant, as a tree propagated from it, and now standing in an adjoining garden, was discovered by us in flower in 1835, and producing only male blossoms. (See *Gard. Mag.*, vol. xi. p. 380.) Some female plants may, however, exist in the country; because it is uncertain how many were originally raised from nuts by Gordon. Messrs. Loddiges inform us that, about 1804, they raised one plant of *Salisburia* from the nut; but they are uncertain to whom they sold it. In a garden near Milan, Signor Manetti informs us, there is a female salisburia, which flowers every year. The singularity and beauty of the foliage of this tree insure it a place in every good collection; and there are accordingly many fine specimens both in England and on the Continent; the dimensions of some of the most remarkable of which will be found in our *Statistics*.

Properties and Uses. The wood of the ginkgo is said by Kæmpfer to be light, soft, and weak; but Loiseleur Deslongchamps describes it as of a yel-

lowish white, veined, with a fine close grain, and moderately hard. It is easy to work, receives a fine polish, and resembles in its general appearance citron wood. It is, he says, much more solid and strong than the ordinary white woods of Europe; and, though the tree is closely allied to the *Coniferae*, it has nothing resinous in its nature. In China and Japan, the *salisburia* appears to be grown chiefly for its fruit, the nuts of which, as Dr. Abel observes, are very generally exposed for sale in the markets of China; though he was not able to ascertain whether they were used as food, or as medicine. In Japan, according to Kämpfer, they are never omitted at entertainments; entering into the composition of several dishes, after having been freed from their austerity by roasting or boiling. They are reputed, he says, to be useful in digestion, and in dispelling flatulence. Thunberg says that even the fleshy part of the fruit is eaten in Japan, though insipid or bitterish; and that, if slightly roasted, skin and all, it is not unpalatable. Some of the fruit which ripened in the Botanic Garden of Montpellier were tasted by M. Delille and MM. Bonafous of Turin, who found their flavour very like that of newly roasted maize. M. Delille says that, after roasting the nuts, he found nothing in the kernels but a farinaceous matter, without the least appearance of oil; notwithstanding what Kämpfer incidentally mentions to the contrary. M. Peschier, a chemist of Geneva, discovered in the husk of the fruit an acid, to which he gives the name of *acide gençoïque* (See *Bibliothèque Universelle de Genève*, as quoted in *Ann. de la Soc. d'Hort. de Paris*, tom. xv. p. 95.) Bunge says that the Chinese plant a number of young trees of the *salisburia* together, in order to produce a monstrous tree, by inarching them into one another; but Delille thinks that this may probably have been done in order to unite male and female trees, for the sake of fertilising the fruit. In Europe, hitherto, the use of the tree has chiefly been as a botanical ornament; but it is suggested by Loiseleur Deslongchamps and others, that, as it grows with great rapidity in the south of France, it may be planted as a timber tree, and applied to the same uses as the ash, of which it has the advantage of being more solid, and having a greater specific gravity.

Soil, Propagation, Culture, &c. The *salisburia*, judging from the specimens in the neighbourhood of London, thrives best on a deep sandy loam, perfectly dry at bottom; but it by no means prospers in a situation where the subsoil is wet. Were this not the case at Pursuer's Cross, the trees there would, doubtless, have been much larger than they are; as, though one of them is the highest in England, yet the head is not so ample, nor the trunk so thick, as that in the Mile End Nursery, which is in a sandy soil on sand. The situation should be sheltered, but not so much so as for many exotic trees, which have longer leaves, and more widely spreading branches; such as the *Magnolia acuminata*, the Ontario poplar, and the *Platanus occidentalis*. In Scotland, the *salisburia* is considered rather tender, and is planted against a wall. It is propagated by layers, of two-years-old wood, which generally require two years to be properly rooted; but, on the Continent, it has been found that, by watering the layers freely during the summer, they may be taken off in the autumn of the year in which they were made. Cuttings made in March, of one-year-old wood, slipped off with a heel, root in a mixture of loam and peat earth in the shade; and their growth will be the more certain if they have a little bottom heat. Cuttings of the young wood, taken off before midsummer, and prepared and planted with the leaves on, in sand, under a bell-glass, will, we have no doubt, succeed perfectly. In France, Loiseleur Deslongchamps informs us that, in some soils and situations, cuttings grow with such rapidity, that in three or four years they form plants 6 ft. or 7 ft. high. (*Aman.*, &c., tom. xv. p. 96.) Poiteau observes that, in some cases, plants raised from cuttings and layers are apt to form a crooked head of slow growth; but that, after the trees are two or three years old, if they are cut over by the surface, or pegged down to the ground, they will throw up shoots like other trees that stole; one of

which may be chosen, and trained so as to form a handsome erect tree. It may be worthy of notice, that the two male trees which flowered first in England were trained against walls, and that the flowers appeared only in small quantities, at the extremity of the longest branches. It also deserves notice, that the tree in the Strasburg Botanic Garden, which, when we saw it in 1828, had flowered for several years in succession, was not above 20 ft. high: but it had been almost entirely shaded by a large poplar tree; and the flowers were only produced on the extremity of one branch, which had stretched out to the light. The same may be said of the tree which flowered in a garden adjoining the Mile End Nursery, which had the farther stimulus of the bark of the trunk having been so much injured for some years before as to operate like ringing. The grafting of the salisburia may be performed in the splice manner, and, apparently, with as much facility as in grafting apple trees; and, hence, every possessor of a male tree may add a female to it if he chooses.

Statistics. In the environs of London, a tree at Pursers Cross, planted in 1767, was, in 1837, upwards of 60 ft. high; another tree near it is upwards of 50 ft. high. In the Mile End Nursery are several trees, the highest of which (figured in our last Volume) was, in 1834, 57 ft. high, with a trunk 3 ft. in diameter; and in 1837 it had gained 3 ft. in height. In the grounds of an adjoining villa, there is a tree between 30 ft. and 40 ft. high, which has grown all to one side, in consequence of the pressure of other trees. This tree produced abundance of male blossoms in May, 1835, and is now (June 5, 1837) also in flower. In the Kew Garden there are some male trees trained against walls, one of which has flowered several times (see p. 2096.); and a female tree, received from Professor De Candoille, in 1818., but which has not yet flowered. In our garden in Porchester Terrace, Baywater, is a male tree, with a female grafted on its summit, which is now (1837) upwards of 15 ft. high. At Ham House, Essex, is a male tree, trained against the front of the house, which flowered about 1796, and is 33 ft. high. At Leyton, in the grounds of Robert Barclay, Esq., 16 years planted, it is 18 ft. high.—South of London. In Dorsetshire, at Melbury Park, 80 years planted, it is 24 ft. high. In Somersetshire, at Leigh Park, it is 40 ft. high, the circumference of the trunk 5 ft., and the diameter of the head 30 ft.—North of London. In Gloucestershire, at Doddington Park, 96 years planted, it is 18 ft. high, the diameter of the trunk 10 in., and that of the head 45 ft.—In Scotland, in Forfarshire, at Kinaird Castle, 30 years planted, it is 22 ft. high.—In France, in the Jardin des Plantes, 50 years old, it is 55 ft. high, the diameter of the trunk 3 ft. 4 in., and of the head 25 ft. At Avranches, in the Botanic Garden, 19 years old, it is 6 ft. 6 in. high.—In Holland, at Utrecht, the tree already mentioned, p. 2095., is 33 ft. 2 in. high, with a trunk 1 ft. 6 in. in diameter at 1 ft. from the ground Professor Kops informs us, in a letter dated December 7, 1835, that it is a branchy tree, and still continues to grow vigorously. He adds that, when he succeeded to the directorship of the garden, in 1816, it was then calculated to be between 70 and 80 years of age; and, hence, it must now (1837) be between 90 and 100 years old; and, if so, it must have been planted at Utrecht before the tree was introduced into England. At Leyden, there is a salisburia, which, in 1817, the deputation of the Caledonian Horticultural Society considered as a few feet taller than the specimen in the Mile End Nursery was at that time; which last-mentioned tree was, when seen by the deputation in 1817, above 30 ft. high, and was considered, as it still is, the finest tree of its kind in the neighbourhood of London. The Leyden tree was inferior to the English one, however, in point of handsomeness and shapeliness. "Indeed, it had been crowded and overgrown by some ordinary forest trees; and the gardeners seemed to pride himself on its transference, some years ago, to its present situation. There was doubtless merit in safely removing so large a plant; but the choice of its new place is far from being happy, a large common ash here overbadowing it; than which it is not easy to conceive any thing more prejudicial. It yields its flowers every season." (*Hort. Tow.* p. 159.) Professor Reinwardt, the present director of the Leyden Botanic Garden, kindly sent us a beautiful portrait of this tree, taken in 1836, of which *Ag.* 1994. is an engraving, reduced to the scale of 1 in. to 12 ft. It was then 41 ft. high, and the circumference of the trunk, at 1 ft. from the ground, was 4 ft. 6 in.—In Belgium, in the park at Lücken, near Brussels, there is a salisburia 23 ft. high.—In Germany, in Aus-



tris, at Vicenza, in the garden at Schönbrunn, and also in that of M. Parnold, there are several male *salicaria*, from 40 ft. to 50 ft. high, which flower every year. The oldest of these was the tree originally planted in the garden at Schönbrunn by Francis I. (See p. 2096.) In the Botanic Garden at Carlsruhe, there is a tree 60 ft. high, which has not yet flowered. In Brunswick, at Harbke, there is a tree, 70 years planted, and only 50 ft. high. In Switzerland, the female tree at Bourdigny (see p. 2096.) was kindly measured for us in April, 1835, by M. Alphonse De Candolle; and, according to his communication in the *Gardener's Magazine*, vol. xi., it was then from 12 ft. to 15 ft. high, with a trunk exactly 4 ft. in circumference at 18 in. from the ground; and the diameter of the space covered by the branches was 25 ft.—In Italy, in Lombardy, at Monza, 24 years planted, the male is 25 ft. high, the circumference of the trunk 2 ft., and the diameter of the head 18 ft.; there is also a female, 10 years old, which is only 3 ft. high. A female tree, in another garden near Milan, has flowered. In the Botanic Garden at Pavia, a tree, measured by the Abbé Berlesé, in 1832, was 60 ft. high. This must be the finest tree in Italy, as that of Montpellier is the finest in France; that of Carlsruhe the finest in Germany; that of Leyden the finest in Holland; and that of the Mile End Nursery the finest in England.—In North America, at Woodlands, near Philadelphia, there is a tree 54 ft. high, with a trunk 3 ft. 10 in. in circumference at 2 ft. from the ground; there are also two other trees in the same garden, but not one of them has ever flowered. These trees were brought to America, by Mr. Hamilton, in 1784. (See *Gard. Mag.*, xii. p. 378.)

Commercial Statistics. Plants, in the London nurseries, are from 1s. 6d. to 5s. each, according to the size; female plants, 5s. each. At Bollwyller, plants are 5 francs each; and at New York, 2 dollars.

App. I. Half-hardy Genera belonging to the Order Taxaceæ.

Podocarpus L'Hérit. is nearly allied to *Taxus*, and so much resembles that genus, both in its leaves and fruit, that it has not been long separated from it. The species are tall trees, natives of China, Japan, the East Indies, the Cape of Good Hope, South America, and New Holland. About a dozen species have been introduced into England, which are almost always kept in the greenhouse or stove; but some have been found to stand the open air in the climate of London, with very slight protection.

P. macrophyllus Swt., Lamb, 2d ed. 2., p. 843.; *T. macrophylla* Thunb. *Jap.*, 276., *Smith* in *Rees's Cycl.*, No. 6.; the long-leaved Japan yew; has the leaves scattered, pointless, spreading every way, and the fruit stalked. Common in Japan, where it is a large and stout tree, the wood of which is valued for cabinet-work, not being liable to the attacks of insects. It is a native of Japan, and was introduced into the Kew Gardens in 1804. There are plants at Messrs. Loddiges's, and in various collections, which are usually kept in green-houses or cold-pits; but there is a plant in the Horticultural Society's Garden, which was planted in 1832 in an angle where two walls meet, and is now (1837) between 2 ft. and 3 ft. high.

P. latifolius Wall.
Plant. Asiatic Rar., 1. p. 26. t. 30., and our *fig.* 1995., has the leaves ovate-lanceolate, much pointed, and opposite. Male catkins fasciated, axillary, on a common peduncle. Nut globose; receptacle narrow, covered with scattered bractea. An evergreen tree of the middle size. Leaves about 5 in. long, and 1 in. broad; pale beneath. (*Wall.*) A native of the mountains of Pundna, flowering in March, and ripening its fruit towards the end of the year. It is called *Sop-long* by the natives. Dr. Wallich observes, this species "is very distinct from *P. macrophyllus* in size, figure, and insertion of its leaves, and in its fasciated aments. Both species are found on the same lofty range of mountains, bordering on the eastern parts of Bengal, not far from the district of Silhet." (See *Tenasserim Floræ Nepalesis Illustratæ*, 1. p. 56.)

P. spinulosus Sprengel; *P. excelsus* Lodd. *Cat.*, ed. 1836; *T. spinulosa* *Smith* in *Rees's Cycl.*, No. 7.; has the leaves partly opposite, or whorled, and lanceolate; spinous-pointed, and spreading every way. It is a native of Fort Jackson, and there is a plant in the Botanic Garden at Kew, against a west wall, which has stood there without protection since 1830, and is now 3 ft. high.

P. schaffneri Persoon; *T. rostrata* *Karstg. Awara. Ex.*, p. 815., *Icon.*, *Smith* in *Rees's Cycl.*, No. 5., *Ten. Fl. Nep.*, t. 64.; has the leaves 8-ranked, distant, lanceolate, pointed, and but half the length of the fruit; and the foliage and habit of the plant strongly resemble those of a deciduous cypress. Frequent, according to *Karstg.*, in the northern provinces of Japan, where it forms a lofty tree, with many opposite scaly branches, found also on mountains in Nepal and Kamaon. The wood is light. An oil is made from the kernel of the nut, which is said to be used for culinary purposes, though the kernel itself is too astringent to be eaten. This species was introduced in 1820, and is, perhaps, the hardiest of the genus; a plant having stood out in open ground in the Gohkworth Arboretum since 1831, which is now 4 ft. high. It is also at Messrs. Loddiges's. In 1834 there was a tree of this species at White Knights, which was 13 ft. high.





T. elongatus L'Hérit. Richard Confif., p. 13 t. 1. f. 2., and our *fig.* 1997; *T. elongatus* *Att. Hort. Kew.*, ed. 1., 3. p. 416., *Taxa. Prod.*, 117., *Smith in Rees's Cycl.*, No. 3; has the branches somewhat whorled. Male flowers cylindrical, with spirally imbricated and very numerous anthers. These scale-like anthers of the male flower are very like those of a fir. A native of the Cape of Good Hope, sent to Kew in 1774. There are plants at Messrs. Loddiges's.

T. chilensis Rich. *Mém. Confif.*, p. 11. t. 1. f. 1., and our *fig.* 1996., is a middle-sized tree, a native of Chili, where it is called Manigui, and whence specimens of the male plant were sent to Europe, by the collector Dombey.

T. coridiacus Rieb. *Confif.*, t. 1. f. 3., and our *fig.* 1998., is a native of the island of Montserrat, and resembles *T. elongatus*, but is smaller in all its parts.

T. taxifolius Kunth in Humb. and Bonp. *Nov. Gen.*, 2. p. 2. t. 97.; Rich. *Mém. Confif.*, pl. 29. t. 1., and our *fig.* 1999., and 2000.; *Taxus montana* Willd. *Sp. Pl.*, 4. p. 837.; This is a tree with the habit of *Taxus baccata*, a native of Peru, and of which only the female plant has hitherto been sent to Europe. Some curious

information respecting the anatomy of its fruit will be found in Richard's *Mémoire*, p. 15. There are plants at Messrs. Loddiges's.



Other Species. At Messrs. Loddiges's, there are *Podocarpus excelsus*, and *P. seriffolius*; and also *Taxus japonica*; but whether they, and also several of the names above given, are applied to plants sufficiently distinct, or whether they are synonyms, we have no means of ascertaining. In Lambert's *Pissus*, 2d ed., vol. ii., several species are mentioned, or shortly described, as natives of Chili and New Holland, affording an example of coincidence in the vegetation of these countries, with that of the south of Africa.

Descriptions. Solander. Sexes dioecious. Flowers minute.

— Male. Catkin solitary, terminal, oblong. Flowers imbricated, each consisting of a scale and two cases of pollen attached to its lower part on the outside. — Female. Flowers terminal, solitary; each borne upon the surface of the last leaf

of a shoot, and part of it embraced by that leaf, and by contiguous ones; and included within a cupule-like or calyx-like involucre, which has a terminal orifice, that widens more and more; and the involucre eventually becomes a cupule-like body, of a firm fleshy consistence, and situated at the lower part of the fruit. Calyx globose turbinate, but contracted towards the tip, and then expanded into glandular, narrow, and spreading limba. Pistil almost wholly free, included. Fruit rather egg-shaped, tipped with a small point. Two species have been described, and are introduced.

D. cupressinum Sol. in *Forst. Pl. Es.*, p. 80., *Prod.*, p. 92., *Lam. Pin.*, p. 93. t. 41. ed. 2., il. t. 69., Rich. *Mém. Confif.*, p. 137. t. 2., and our *fig.* 2001.; *Thalassia cupressina* Spreng. This is a tall evergreen tree, with pendent branches, and the small shoots covered with numerous dichotomous (2-rowed) scaly-looking leaves, not unlike, at a distance, those of *Lycopodium*. The male catkins are sessile, oblong-ovate, imbricate, with many flowers. The female flower, which is shown in *fig.* 2001. a., is produced at the summit of the leaf, and is included in an involucre, which forms a sort of cup, and conceals the pistillum from the view. It is a native of New Zealand, where it was discovered by Dr. Solander, during Cook's first voyage. In Cook's second voyage, he made the shores of New Zealand, at a place which he had previously named Dusky Bay, in March, 1773. "The country at the back of this bay is described as exceedingly mountaneous, the hills forming part of that great chain which extends throughout the larger island from Cook's Straits. These hills are said to wear an aspect, than which a more rude and craggy feature can rarely be seen; for the mountain summits are of stupendous height, and consist of rock, totally barren and naked, except where they are covered with snow. Skirting the sea shore, the land and all the islands in the bay are densely clothed with wood, nearly down to the water's edge. Except in the river Thames (a river of New Zealand), Captain Cook adds, "I have not seen finer timber in all New Zealand. The most considerable for size is the spruce tree (*Dacrydium cupressinum* Sol., many individuals of which were observed from 6 ft. to 8 ft. or 10 ft. in girth, and from 60 ft. or 80 ft. to even 100 ft. high, quite large enough to make a main mast for a fifty-four gun ship." Of the leaves of this tree Cook made beer, which he gave to his ship's company; and which, when well prepared, and corrected from its extreme astringency by a decoction of philadelphus, or tea plant (*Leptospermum scoparium*), proved a good antiscorbutic, and was acknowledged to be little inferior to the American spruce beer, by those who had experience of both. (*Comp. to the Bot. Mag.*, vol. ii. p. 228.) Mr. George Bennett, in his *Observations on the Conifera of New Zealand*, published in Lambert's *Pissus*, says that he has seen the *Dacrydium cupressinum* growing to the height of 80 ft. or 90 ft., but with a trunk seldom exceeding in circumference 15 ft. The timber is considered



harder than that of any of the New Zealand Coniferae, and is much valued either for planks or spars. In colour it is an intermixture of white and red; and no green resin exudes from it. The fruit, which is a small red berry, containing a black seed, is eaten by the natives. The tree is not abundant, having its habitat only in particular districts. *Dacrydium cupressinum* was introduced into England in 1825, and there are now plants in several collections. From its native country, we think it not unlikely to prove hardy; and, without doubt, it will stand our winters against a wall, with very little protection. It is propagated by cuttings, like heaths.

D. taxifolium Soland., Lam. Pin., ed. 2., No. 69., is mentioned in Captain Cook's First Voyage as growing in swamps, and forming a very tall tree, with a leaf not unlike a yew, and berries in small bunches. Captain Cook's carpenter thought it fit for masts for vessels of any size. It has not yet been introduced.

D. excelsum Don, Lam. Pin., ed. 2., the kahikatea, or swamp pine, was observed by the late Mr. Richard Cunningham on the Hokianga River, in January, 1834, "laden with the climbing freycinetia, whose rooting rope-like stem, with here and there a tuft of leaves, wound itself spirally to the summits of those straight and lofty trees." (*Comp. to Bot. Mag.*, ii. p. 217.) Mr. George Bennett says that this species attains a height of from 150 ft. to 130 ft., with a trunk from 12 ft. to 18 ft. in diameter, being the loftiest timber tree in New Zealand. The wood is soft, and used for making the common canoes; the great length of the trunk enabling them to be constructed of a large size for carrying provisions.

D. plumosum D. Don, the *katoko* of the New Zealanders, is a tree attaining the height of 60 ft. or 70 ft., and regularly furnished with branches, which, Mr. Bennett informs us, is the meaning of the name given to it by the natives. The timber is red, and of an excellent quality for either plank or spar.

D. celticum Wall, *Juniperus elata* *Roarb.*, is a lofty evergreen tree, a native of Pulo-Penang. Introduced in 1830. There are plants at Messrs. Loddiges's, and a very handsome one in Knight's Exotic Nursery, King's Road, Chelsea.

Phyllocladus Rich. *Mém. Conif.*, p. 129.; *Podocarpus* sp. *Labill.* This is a manecious genus, with small obscure male and female flowers in separate catkins. The fruit resembles that of *Taxus*. Only one species is known.

P. rhomboidalis Rich. *Mém. Conif.*, p. 23. t. 3. f. 2. and our figs. 2002, 2003.; *Podocarpus asplenifolius* *Labill. Specim. Nov. Holl.*, 2. p. 71. t. 221. A branchy tree, according to Labillardière, from 40 ft. to 50 ft. in height. The branches are spreading; the leaves angular, with foliaceous wing-like appendages at their base, and varying so much in the manner in which they are cut, as occasionally to appear pinnatifid. At their apex, there are sometimes little leafy appendages, which at length become leaves. The flowers are monocious; the male and female on different branches, and terminal. The leaves appear to be compressed branches, in manner of those of *Xylophylla*. It is a native of Cape Van Diemen; and only dried specimens have hitherto been introduced.

P. trichomanoides R.Br., and D. Don in *Lamb. Pin.*, ed. 2., vol. ii., the *tanaka* of the natives, is described by Mr. G. Bennett, as having pinnate frondose leaves, and attaining the height of from 60 ft. to 70 ft., with a trunk from 14 ft. to 16 ft. in circumference. The timber is hard, and so heavy that it sinks in water. The bark is used by the natives for dyeing the New Zealand flax of a red or black colour; the black New



Zealand mats being dyed by simply immersing them in a decoction of the bark of this tree. Mr. Richard Cunningham describes *P. trichomanoides* as of "graceful regular growth" and as "furnishing an exceedingly valuable timber, which is much sought after for the decks of ships." (*Comp. to the Bot. Mag.*, ii. p. 218.)

We have dwelt at greater length on the trees of New Zealand, than we should otherwise have done with half-hardy species; because, from the climate, and the elevation at which some of them are found, we are inclined to hope that they may prove half-hardy in the climate of London, and nearly, if not quite, hardy in the warmest parts of Devonshire. The singularity of the appearance of *Phyllocladus*, and its obvious alliance to *Salisburia*, would render it a most desirable introduction, either for the green-house or the conservative wall, and possibly it may prove as hardy as *Salisburia*.

CHAP. CXIII.

OF THE HARDY AND HALF-HARDY LIGNEOUS PLANTS OF THE ORDER CONIFERÆ, OR PINACEÆ.

Identification. Lindl. Nat. Syst. of Bot., p. 313; Richard Mém. Conif., in part.

Synonymes. Coniferæ Rich. Mém. Conif. The Coniferæ, till lately, included the order Taxaceæ, already given p. 5065, which has been separated from it by Dr. Lindley. Coniceæ Lindl. Key, 232.

Affinities. The Taxaceæ have been separated from this order on the one hand, while, on the other, the Cycadaceæ are considered as approaching very near it.

General Characters of the Order. All ligneous. Flowers unisexual; those of the two sexes in distinct catkins, that are situated upon one plant in most of the species, and upon two plants in the rest. — Male. Catkin longer than broad. Each flower a scale or body, bearing pollen contained within either 2 cells formed within the scale or body, or 3 or more 1-celled cases; in *Araucaria* Juss., in 2-celled cases, exterior to, but united with, the scale or body: a part of the scale or body is free, above the cells or cases containing the pollen. — Female. Catkin more or less conical, cylindrical, or round, in figure; composed of many, several, or few flowers, each, in most species, subtended by a bractea. The catkin, in the state of fruit, is rendered a strobile of much the same figure. Each flower is constituted of 1—3 ovules, borne from an ovary that resembles a scale, and is in some instances connate with the bractea that subtends it. Ovules regarded as receiving impregnation from direct contact of the pollen with the foramen of the ovule. Bracteas imbricated. Carpels, which are the ovaries in an enlarged and ripened state, imbricated. Seed having in many species a membranous wing. Embryo included within a fleshy oily albumen, and having from 2 to many opposite cotyledons, and the radicle being next the tip of the seed, and having an organic connexion with the albumen. Brown has noticed a very general tendency in some species of *Pinus* and *Abies* to produce several embryos in a seed. — Trees, almost all evergreen, the wood abounding in resin. Leaves needle-shaped, scale-like, or lanceolate; in some species disposed in groups, with a membranous sheath about the base of the group, at least in most of these; in some in rows, in some oppositely in pairs, decussate in direction; imbricately in several. (Lindl. Nat. Syst. of Bot.; T. Nees ab Esenbeck Gen. Pl. Fl. Germ. Illustr.; Richard Mém. sur les Conifères; Wats. Dendr. Brit.; and observation.)

The Coniferæ were first studied scientifically by Tournefort. In his *Institutiones, &c.*, published in 1717–19, this botanist established the following nine genera; viz., *Abies*, *Pinus*, *Larix*, *Thuja*, *Cupressus*, *Cedrus*, *Juniperus*, *Taxus*, and *Ephedra*. Linnæus, in his *Genera Plantarum*, published in 1737, only admitted seven of Tournefort's genera, uniting *Larix* to *Abies*, and *Cedrus* to *Juniperus*. Adanson, in 1763, in his *Families des Plantes*, adopted Tournefort's genera, with the exception of *Cedrus*, which, with Linnæus, he united to *Juniperus*; and he added to the Coniferæ the genera *Casuarina* Rumph., and *Equisetum* L. A. L. De Jussieu, in 1789, in his *Genera Plantarum*, formed the family of Coniferæ of the seven genera adopted by Linnæus, placing there the *Casuarina* of Rumphius, and adding the genus *Araucaria*. Lamarck (*Encyc. Méth.*, ii. p. 32., published in 1790), under the article Coniferæ, adopted the genera of Linnæus and Jussieu, with the exception of *Araucaria*, which he describes, in another part of his work, under the name of *Dombeya*. Gærtner, in 1791 (*De Fruct. et Sem. Plant.*), united in one

group, under the name of *Pinus*, the genera *Pinus*, *Abies*, and *Larix* of Tournefort; and adopted the genera *Thuja*, *Juniperus*, *Cupressus*, and *Taxus* as characterised by Linnæus. Solander, in 1786, in a *Dissertation* published at Berlin by G. Forster, indicated the *Dacrydium cupressinum* as a new genus belonging to *Coniferae*, but did not give its character. Lambert, the vice-president of the Linnæan Society, published, in 1803, the first volume of his magnificent work, *A Description of the Genus Pinus*, the second volume of which was published in 1832, and the third in 1837. L'Héritier founded the genus *Podocarpus* in 1806, and Smith that of *Salisburia* in 1796. Persoon added the genus *Altingia* to *Coniferae*, having mistaken a species of *Liquidambar*, the aboriginal name of which is *Altingia*, for one of the *Coniferae*. R. A. Salisbury published, in 1807, in the *Linnæan Transactions*, vol. viii., some curious observations on the stigmas of the *Coniferae*, and endeavoured to establish four new genera; viz., *Bélis* (*Cunninghania*), *A'gathis* (*Dammara*), *Eutassa*, and *Colymbæa* (*Araucaria*). Ventenat, in 1808, gave a new character to the *Thuja articulata* of Desfontaines, which he named *Callitris*. M. Targioni Tazzetti of Florence published, in the *Annals of the Museum* of that city, *Observations on the Coniferae*, and particularly on the genera *Thuja* and *Cupressus*, which he unites in one genus. MM. Mirbel and Schubert have published, in the *Annales du Muséum de Paris*, tom. xv., and in the *Bulletin des Sciences de la Société Philomatique*, tom. iii., and in various other works, many observations on the *Coniferae*. Both these botanists have proposed a new classification of the genera which compose the order, arranging them into two groups: the one containing the genera in which the flowers are turned up, and the other all those in which they are turned down. M. Mirbel, in 1812, separated the *Cupressus disticha* from the other species of that genus, and described it under the name of *Schubertia*; a name which has not been generally adopted, because it was found that M. Richard, senior, had already described it under the name of *Taxodium* in the *Annales du Muséum*, tom. xvi. M. Tristan, in the same volume of the *Annales*, endeavours to show that *Abies* and *Larix* ought to be united, as *Linnaeus* and *Gartner* had previously done. In this volume appeared also a new classification of the genera composing the *Coniferae*, by M. Richard, senior; in which he endeavoured to establish the three groups or sections of *Taxineæ*, *Cupressineæ*, and *Abietineæ*; and this arrangement is adopted in the same author's justly celebrated work, *Mém. sur les Conifères*, published after his death by his son, M. Achille Richard, in 1826. It is the arrangement of this author, as modified by Dr. Lindley in the edition of his *Introduction to the Natural System* published in 1836, that we have followed in this work; and the characters of the genera have been either drawn up or amended for us by Professor Don; who has also kindly looked over the proof sheets. By Dr. Lindley's arrangement, Richard's section *Taxineæ* is removed from the *Coniferae*, and made a separate order, under the name of *Taxaceæ*, as given in p. 2065.; and, under Richard's two sections *Abietineæ* and *Cupressineæ*, the true *Coniferae* are arranged as follows:—

Sect. I. ABIE'TINÆ Richard.

Sect. Char. All the genera included in the group are evergreen, except *Larix*. Branches in whorls; except, perhaps, in *Dammara*. Buds scaly. Catkins of each sex of numerous flowers. Tip of the ovule pointing towards the axis of the catkin, except in *Cunninghania*. Leaves scattered, or in groups.

* *Sexes monœcious.*

PI'NUS L., in part. Male. Catkins grouped. Pollen contained in 2 cells, formed in the scale, that opens lengthwise.—Female. Ovules 2. Strobile ovately conical in most species. Carpels, or outer scales, thickened at the tip, exceeding the bractæ or thin outer scales in length, and concealing them: persistent.—Leaves in groups of 2, 3, or 5; each group arising out of a scaly sheath.

Abies Link. This differs from *Pinus*, as above defined, in having the cones pendent, and less decidedly grouped; the strobiles cylindrically conical; the carpels not thickened at the tip; and the leaves solitary. They are partially scattered in insertion, and more or less 2-ranked in direction.

Picea Link. This differs from *Pinus* and *Abies*, as above defined, in having the cones erect. The strobile is cylindrical, and has its carpels not thickened at the tip. Both carpels and bracteas separate from the axis of the strobile; and the leaves are obviously 2-ranked in direction. (*D. Don.*)

Larix Torr. This differs from *Abies*, as above defined, in its leaves being annual, and disposed in groups; and in having the cones erect.

Cedrus Barrelier. This differs from *Larix* in being evergreen, and in the carpels separating from the axis. The leaves, as in *Larix*, are disposed in groups, many in a group; and the cones are erect. Anthers crowned by an elliptical scabrous crest. Strobiles solitary; crest with coriaceous compressed carpels, which are deciduous.

Cunninghamia R. Br. Male. Catkins grouped. Pollen contained in 3 cases that depend from the scale.—Female. Ovules 3. Strobile ovate.—Leaves solitary, scattered in insertion, more or less 2-ranked in direction, flat, acuminate, and serrulate.

Dammara Rumphius. Male. Catkins solitary. Pollen contained in from 5 to 24 cases, pendent from the apex of the scale.—Female. Ovules 2, free. Strobile turbinate.—Leaves ovate-lanceolate, often opposite.

* * *Sexes* [?] *diœcious.*

Arucaria Jussieu. Male. Pollen contained in from 10 to 20 cases, pendent from the apex of the scale. Ovule solitary, connate with the carpel or scale. Leaves imbricate.

Sect. II. *CUPRESSINÆ Richard.*

Sect. Char. All the kinds evergreen, except *Taxodium Rich.* Branches inserted scatteredly in most, if not all. Buds not scaly. Flowers of each sex but few in a catkin. Ovule with its tip pointing from the axis of the catkin.

* *Sexes monœcious.*

Thuja Rich. Male. Catkin terminal, solitary. Pollen of each flower included in 4 cases, that are attached to the inner face of the scale, towards its base.—Female. Catkin terminal. Ovary connate with the bractea: the two conjoined may be termed a receptacle. Ovules 2 to each receptacle. Receptacles semipeltate, imbricated, smooth, or, in some, having a recurved beak near the tip. Seeds inconspicuously winged, or not winged. Cotyledons 2.—Branchlets compressed. Leaves scale-like, closely imbricated, compressed.

Callitris Vent. Male. Catkins terminal, solitary. Pollen of each flower contained in 2—5 cases, attached to the lower part of the scale, which is peltate.—Female. Catkin terminal, of 4—6 ovaries, or else receptacles, each spreading at the tip, and disposed upon so short an axis as to seem, in the state of fruit, the valves of a regular pericarp, at which time each has a micro near the tip. Ovules 3 to many to each ovary, or receptacle. Seed winged.—General appearance like that of the kinds of cypress. Branches jointed. Leaves minute, scale-shaped, opposite or whorled, situated under the joints of the branches.

Cupressus L. Male. Catkin terminal, solitary. Pollen of each flower contained in 4 cases, attached to the scale on the inner face at the lower edge. Scales peltate.—Female. Ovaries each connate with the bractea, thus constituting a receptacle. Ovules to each receptacle 8 or more. Strobile globose. Receptacles, as included in the strobile, peltate, having an obscure tubercle at the tip; disposed collaterally, not imbricately. Seeds compressed, angular; affixed to the narrow basal part of the receptacle. Cotyledons 2.—Leaves appressedly imbricated.

Taxodium Rich. Male. Catkins disposed in a pyramidal compound spike.

Pollen of each flower borne in 5 cases, attached to the scale at its inner face.—Female. Catkins 2—3 together, near the base of the spike of catkins of male flowers, each consisting of a small number of flowers. Oviples 2 to an ovary. Strobile globose. Scales peltate, angled. Seed angled in outline, and having angular projections on the surface; its integument very thick. Cotyledons 6—7.—Leaves linear, disposed in 2 ranks. Annual.

** *Sexes dioecious, or rarely monoecious.*

JUNIPERUS L. Male. Catkins axillary or terminal. Pollen of each flower in 3—6 cases, attached to the basal edge of the scale, and prominent from it.—Female. Catkin axillary, resembling a bud; consisting of 1—3 fleshy ovaries; bracteated at the base. Ovules 1 to an ovary. The ovaries coalesce, and become a fleshy juicy strobile, resembling a berry. Seeds 1—3, each obscurely 3-cornered, and having 5 gland-bearing pits towards the base.—Leaves opposite or ternate, narrow, rigid, and not rarely minute and scale-shaped.

Sect. I. ABIE'TINÆ.



THE *Abiétinæ*, or the pine and fir tribe (*arbres verts, Fr.*; *nadelholz, Ger.*) are timber trees, as important in the construction of houses, and in civil architecture generally, as the oak is in the construction of ships, and in all kinds of naval architecture. The trees of this section of the *Coniferæ* are so different in their external appearance, not only from the trees of all other orders, but even from the section *Cupressinæ*, that they might well form an order of themselves. The *Abiétinæ* are almost all trees of lofty stature, pyramidal in form, and regularly furnished with verticillate frond-like branches, from the base to the summit of the trunk. These branches, unlike those of every other kind of tree, die off as the tree grows old, without ever attaining a timber-like size; so that, in a physiological point of view, they may be considered as rather like immense leaves than branches; and this circumstance, as well as others, seems to connect the pines and firs with the palms. Almost all the species are evergreen, and have linear needle-like leaves; whence the German names of *nadelholz* and *tangelholz*. The number of *Abiétinæ* described by Linnæus amounted to no more than 12 species. Smith, in 1819, in Rees's *Cyclopædia*, described 35 species; and in Lambert's *Genus Pinus*, the last volume of which was published in 1837, 66 species are described. Besides these, some others have been introduced, of which little is yet known; so that the number in British collections is considered to amount to upwards of 70 species, exclusive of varieties. They are all natives of temperate regions, and chiefly of the northern hemisphere. On the poorest description of dry soil, a greater bulk of valuable timber will be produced in any given time by a crop of *Abiétinæ* adapted to it, than by a crop of any other natural order of trees whatever. According to Delamarre, the proportion between the timber produced by the common pines, and the common broad-leaved trees of Europe, in a poor dry soil, in any given time, is as 10 to 1.

Description. In regard to general form, the *Abiétinæ*, when full grown, and beginning to decay, are partly trees with spiry tops, and partly round or flat-headed trees. The genera *Abies*, *Picea*, and *Larix* form conical trees, of the utmost regularity of figure, in every stage of their growth; the different species of *Pinus* and *Cedrus*, on the other hand, form regular cones when they are young, and until they attain a certain age; but their heads become round or flattened as they grow old; the branches near the bottom of the trunk drop off, and those near the summit increase in thickness, and in lateral extension; and hence the grandour of the heads of these trees, when favourably situated and of great age. The genus *Cedrus* is remarkable for the horizontal direction

taken by its branches in every stage of its growth; and the branches of *Abies canadensis* are equally remarkable for their slenderness, and drooping character.

The roots of the *Abietinæ* differ from those of almost all other trees, in not descending perpendicularly; but, both in young and old trees, spreading along the surface of the ground; and, very generally, after the trees have attained some age, swelling and appearing above it. They are numerous, and of less thickness in proportion to that of the trunk, than in the case of any other trees, except the palms; but, being near the surface, and often partially above it, they are of a more tough and woody nature, and are, consequently, better able to resist the action of the wind on the head of the tree, than in the case of trees the roots of which run deep under ground, and which are consequently much less tough and woody. The vitality of the roots of some species is most extraordinary; stumps of the silver fir (*Picea pectinata*) having been found in a growing state, but without leaves, after the trunk had been cut down for upwards of 40 years. The roots of none of the species throw up suckers; nor, when the stems are cut down, do shoots spring from the collar. In some species, as in *P. Tæda* and its varieties, numerous abortive shoots, or tufts of leaves, are produced from the old trunk; and some of the Asiatic and Mexican species also indicate this tendency, though in a much slighter degree.

The trunk, in all the species, grows erect and straight; in some, as in the *Picea pectinata* of Europe, it attains the height of 130 ft. or upwards, with a diameter of from 4 ft. to 8 ft.; and, in the *Picea grândis* of America, it is said to attain the height of 200 ft. The stem is almost always beautifully and regularly tapered, and without those large protuberances common in trees which have their branches of equal durability to the trunk itself, and of like capacity for attaining as large a size. Where the *Abietinæ* have been grown close together, the trunks are almost always straight, and frequently without a single branch to the height of 80 ft. or 100 ft.; the side branches, in such cases, prematurely decaying, from the absence of light and air. Trunks of this kind are common in the spruce fir plantations of Sweden and Norway; and they constitute the fir poles of commerce, so much used throughout Europe as masts for small craft, and as supports for scaffolding. Trunks of the same character are also found in the pine forests of the north of Europe and of North America: and from them are made the masts of the largest American ships; and the beams, rafters, joists, and boards, used in civil architecture, and particularly in the construction of houses in the temperate climates of both hemispheres.

The branches, in the greater number of the species, are verticillate, horizontal in their direction, uniform in their size and shape, and, with the smaller shoots, especially in old trees, generally pendent. In all, the main shoot of the branch is slender, and never attains a great thickness. In some genera (as in *Picea*) the branches are frondose, and quite flat; having a slender main shoot, regularly furnished with smaller side shoots; which are again subdivided into numerous twigs, or spray; and the surface of the whole is flat, like that of the leaf of a fern. In *Abies* and *Larix*, the side branchlets, which proceed from the main shoot of the branch, are for the most part pendent. In *Cedrus*, the branches are more woody than in the case of any other genus; and in *Pinus* least frond-like. As the tree advances in growth, the branches die off, beginning from below; more especially, where several trees have been associated together. There are, however, exceptions in the case of single trees in favourable situations, when the branches assume a woody and permanent character; and this is very frequently exemplified in single trees of the cedar, the silver fir, and the Scotch pine, which have had their trunks broken over at a certain stage of their growth. Indeed, pinching out the leading shoot of any species for two or three years in succession, when the tree is young, will generally cause it to produce, instead of a single trunk, a number of trunk-like branches, which form a bushy tree,

of a character anomalous to that of the *Abietinæ* in general. This anomalous character will be illustrated by the portraits of a silver fir, and some spruce firs, which we shall give in a future page.

The bark of the *Abietinæ* is thin in young trees; and, in some species of *Abies* and *Picea*, even in old trees, it is never either very thick, or very rough. In many species of *Pinus*, on the contrary, it becomes very thick, rigid, cracked, and deeply furrowed in old trees, from the trunks of which it may be cut in large plates.

The wood is chiefly composed of parallel fibres, arranged in a manner somewhat intermediate between that of dicotyledonous and monocotyledonous trees; and, in consequence of these fibres not being very close, the wood is elastic and resilient. Being resinous, it is also, in general, very durable, and of great combustibility. Michaux remarks that "the branches of resinous trees consist almost wholly of wood of which the organisation is even more perfect than it is in the body of the tree, and that the reverse is the case with trees having deciduous leaves. As soon as vegetation ceases in any part of the tree, the consistence of the wood speedily changes; the sap decays; and the heart, already impregnated with resinous juice, becomes surcharged to such a degree as to double its weight in a year. The accumulation is said to be much greater after 4 or 5 years; the general fact may be proved by comparing the wood of trees recently felled, with that of others long since dead." (*N. Amer. Syl.*, iii. p. 143.)

The leaves are, in almost every case, linear, subulate, acicular, and persistent; though in *Cunninghamia* they are lanceolate, and in *Dammara* oblong. In some species they remain on for four or five years, and, in *Arucaria*, for ten or twelve years. In only one genus (*Larix*) are they deciduous. In *Pinus*, *Larix*, and *Cedrus*, they are placed together in bundles of from 2 to 6 in a bundle; but in *Abies* and *Picea* the leaves are single. Where the leaves are in bundles, they are considered by botanists as abortive shoots; because the rudiments of a shoot are found at the base of the leaves: and hence, in pine plants of only one or two years' growth from the seed, the leaves are solitary; and it is only in the third or fourth year that in the axils of these solitary leaves small short shoots appear, each terminating in a fasciculus of from 2 to 6 leaves. The leaves of all the species are without stipules; the numerous scales which are found among them when the shoots are newly developed, being considered as belonging to the buds. In *Pinus*, the leaves are in general more than double the length of those of the other genera; the shortest, as in *P. sylvestris*, being from 1½ in. to 2 in. long; while those of *P. Pinaster* are from 6 in. to 9 in. in length, and those of *P. australis Michx.* are from 1 ft. to 1½ ft. In all the other genera, the leaves are not much longer than half an inch; and very rarely, as in *Picea Webbiana*, exceed an inch. The long-leaved species belong to warm climates; and these, when grown in cold climates, have their leaves considerably shortened. In texture, the leaves are hard and coriaceous, as in the case of most evergreens; but those of *Larix* form an exception. The leaves, in all the species, are without lateral nerves; and they are composed of parallel fibres, like those of the *Monocotyledonæ*.

The buds are enclosed in numerous scales, and are developed in the axils of the leaves, or at the extreme points of the shoots. In all the species they are very few in number, compared with those of broad-leaved trees, in which there is a bud either developed, or in embryo, at the base of every leaf. In the *Abietinæ* on the other hand, there is not one bud for a million of leaves; and the few that are found in the axils are almost confined to the genera *Abies*, *Picea*, *Larix*, and *Cedrus*. The buds are most numerous in *Larix*, and least so in *Pinus*, in which last genus they are almost entirely confined to the points of the shoots. In general, the bud which terminates the summit of the tree, and is destined to form its leading shoot, and increase its height, is developed the last; and this retardation seems a provision of nature for the safety of the most important shoot which the tree can produce; thus, in

suring its height rather than its breadth, and the production of timber by the preservation of its permanent trunk, rather than of its temporary and comparatively useless branches.

The flowers are disposed in catkins: they are unisexual, and those of the male are totally different from those of the female. In most species, both male and female catkins are on the same tree; but in *Araucaria*, as far as that genus is known, they are supposed to be on different trees. The male flowers consist of a number of stamens without any floral envelope, but simply accompanied by scales; and are much more numerous than the females, as is generally the case in unisexual plants. The pollen from the anthers of most species, when ripe, drops on the lower branches in such abundance as to change their colour from green to yellow; and both in the Highlands of Scotland, according to Lightfoot; and in the Vosges, in the north-east of France, according to Loiseleur Deslongchamps, it has been carried to a distance by wind, and has fallen on the ground like a shower of sulphur, to the great terror of the superstitious. The female flowers consist of a pistil, or stigma, enclosed in a simple perianth, or calyx, and accompanied by an involucre composed of one, two, or of several scales. There are in most genera two scales to each flower; an exterior one, which is large and thick, and forms the outer surface of the pine and fir cones; and an interior one, which springs from the base of the other, and is thin; and which protects two flowers, that afterwards become two seeds.

The fruit of the *Abietinæ* are all cones, which vary somewhat in form, though they are in general, as the word implies, conical; and they differ in size, from that of *Abies canadensis*, which is about half an inch in length, to that of *Pinus Lambertiana*, which has been found 3 ft. long. The cones which are thickest in proportion to their length are those of *P. Pinea*, *Cedrus*, and *Araucaris*; that of the latter being almost spherical. The largest of all the cones known, is that of *P. macrocarpa*, which is more than 1 ft. in length, and 6 in. in diameter; and which weighs about 4 lbs. In some species of *Larix*, the axis of the cone is continued in the form of a shoot; and in *Picea bracteata* the scales are prolonged in the shape of leaves. In some, as in *Cedrus*, *Pinus Pinea*, &c., the scales, or exterior calyxes, of the cones adhere closely together, and, as they ripen, become almost of a woody texture; in others, as in *P. Strabus*, and in the whole of the species of *Abies*, the scales are loose and open, and of a leathery or soft texture, and may be very easily separated. The seed is readily extracted from the latter description of cones, but with difficulty from the former. The cones in some species, as in *P. sylvestris*, arrive at maturity in the second year; but in others, as in *P. Pinea* and the genus *Cedrus*, not till the third year. In some, they remain on the tree only two years: but in others, as in *P. Tueda* and *Cedrus Libani*, they remain on three or four years; and on *P. pungens* from ten to twenty years.

The largest seeds are those of the *Pinus Pinea*; and the smallest those of some species of *Abies*. The seeds consist of albumen, composed of farinaceous matter, impregnated with resin and oil; in which the embryo is embedded. This oil has an acrid taste; but, as it can be removed by roasting, the farinaceous matter which remains may then be eaten like that of other seeds and roots. Hence all the seeds of the *Abietinæ* may be considered not only as edible, but as highly nutritive. In some species, as the *P. Pinea* of Europe, and the *Araucaria brasiliæna* of South America, the cerebithinate matter in the seeds is so small, that they may be eaten without roasting; while on the other hand, in *Araucaris imbricata*, and in *Cedrus Deodara*, it is so great that the seeds are kilndried by the collectors of them in the mountains, before being brought down into the plains for sale.

In germinating, the seed first swells and bursts at the upper or narrow end, whence the radicle proceeds and turns downwards into the soil; while, soon after, the lower, or thick, part of the seed opens, and the leaves are developed, and rise above the surface of the ground. The seeds in most of the species are polycotyledonous; but in *Cunninghamia* there are only two cotyledons,

and seldom more in *Arucaris imbricata*. In *Pinus inops* there are four cotyledons; in *P. sylvestris* from five to seven; in *Abies excelsa* there are from three to nine; in *Larix europæa* from five to seven; in *Pinus Strobus* eight; in *Cedrus Libani* from nine to eleven; and in *Pinus Pinea* from ten to twelve.

The general structure of the *Abietinæ* is remarkable for its unity. The vessels, both in the leaves and wood, are straight and parallel; the trunk is straight, and the branches and all their subdivisions straight and parallel also. Even the leaves, whether inserted in rows as in the firs, or irregularly round the stem as in the spruces and pines, all stand out parallel, and at right angles to the branches. The branches form whorls; and so do the leaves of the cotyledons. The shape of the fruit is conical, and so is that of the entire tree.

The rate of growth of the *Abietinæ* is, in general, rapid; and the duration of the tree, compared with that of the oak, short. The most rapid-growing species in the climate of London is the *Pinus Laricio*, which will attain the height of 20 ft. in 10 years; and the species of this section generally reach maturity, in the climate of Britain, in from 60 to 100 years. Most of the European species bear cones at about 20 years' growth, or before; the spruce fir, on dry chalky soils, in less than half that period. The pinaster arrives at maturity sooner than any other European pine, but seldom lasts longer than from 40 to 50 years. The European species of slowest growth, and greatest duration, is the *P. Cembra*, which seldom attains more than 30 ft. or 40 ft. in height, but which lives for several centuries. The two species which in Europe are most valuable for their timber are the *P. sylvestris* and the *Larix europæa*. The grandest and most ornamental species is, unquestionably, the *Cedrus Libani*, and the most elegant and graceful the *Abies canadensis*. The species which produce the greatest quantity of timber in the shortest time, in the climate of Britain, are the Scotch pine and the larch; but in favourable situations, both in Germany and Switzerland, these species are exceeded in this respect by the silver-fir; in Spain by the pinaster; and in North America by the Weymouth pine.

The greater number of the species of *Abietinæ* will live in the open air in the climate of London; but some few require to be protected there from the frost.

Geography. The *Abietinæ* enjoy an extensive range, but chiefly in the temperate parts of the northern hemisphere. Some species are found, both in Europe and America, so far north as to be bordering on the regions of perpetual snow; and others, in Central Europe and in Asia, on the Alpine and Himalayan mountains, in places where, from their great elevation, the climate is equally cold. Wahlenberg and Von Buch describe the genus *Pinus* as occupying the extreme limits of arborescent plants, on Mont Blanc and Mont Perdu, lat. 48° 46' and on Solitina, in Lapland, lat. 66°. Next to *Pinus*, the genus *Larix* approaches the nearest to the line of snow. (*Ed. Phil. Journ.*, i. p. 316.) The *Abies* disappears on these mountains about 400 ft. lower than *Pinus*, the species of which extend to within 2800 ft. of the line of perpetual snow. The mean temperature necessary for *Abies* is 37½°, while that for *Pinus* is only 36½°. On the mountains of Mexico, Humboldt and Bonpland found the genus *Pinus* always attaining the extreme limits of arborescent plants, in the same manner as it does in Europe; *P. australis Michx.* they found occupying a zone at the height of 6000 ft. on Popocatepetl. Lieutenant Glennie, R. N., who ascended the mountain of Popocatepetl, in April, 1827, describes the sides of the mountain as thickly wooded with forests of pines, extending to the height of nearly 12,000 ft., beyond which altitude vegetation ceased entirely. The ground consisted of loose black sand of considerable depth, on which numerous fragments of basalt and pumice stone were dispersed. (*Proc. of the Geol. Soc. of Lond.*, No. vi. p. 76., for 1827-8.) In the southern hemisphere, the *Abietinæ* have not been found beyond lat. 18° or 20°. The greater number of them are indigenous

to the north and middle of Europe, to Siberia, and to the temperate parts of North America. Some of the South American species, such as the *Arucaria*, differ considerably in general aspect from those of the northern hemisphere; and still more so do those of Australia and Polynesia, such as *Dammara* and *Cunninghania*. Very few species of Abietinæ are natives of warm climates; for, though a few, such as the *Pinus occidentalis* of St. Domingo, and the *Pinus longifolia* of the East Indies, are found within the tropics, yet they are generally in localities rendered temperate either by their elevation or their proximity to the sea. In Nepal, according to Royle, the Abietinæ are usually associated with the oaks, and "though but small shrubs are found in the vicinity of the highest peaks, no where are more splendid pines to be seen than at 11,000 ft. or 11,500 ft. of elevation. The species most common are, *Picea Webbiana*, *Cedrus Deodara*, *Pinus excelsa*, and *Abies Morinda*." (*Royle's Illustr.*, p. 23.) According to Link, the highest limit of the pine, as scattered trees, on the Himalayas, is 12,300 ft., but the pine woods do not extend beyond from 11,000 ft. to 11,800 feet; though, "at a much higher elevation, poplars 12 ft. in circumference have been observed." (*As. Jour.*, May, 1835, p. 696, as quoted in *Jamson's Journal*, July, 1837, p. 26.) The Abietinæ are almost all social trees, and they are generally found covering extensive tracts of country, while, from their being evergreen, they do this to the exclusion of almost all other trees and shrubs; a pine forest consisting more exclusively of pines, than an oak forest does of oaks, or a forest consisting principally of any other kind of deciduous tree does of that from which it takes its name. The nearest to the Abietinæ in exclusiveness is the beech. (See p. 1966.) The Abietinæ, with very few exceptions, are found in thin soils, on rock, or on a cold but dry subsoil; and but a few species, such as the *Abies excelsa* and *A. canadensis*, delight in situations where the surface of the ground is saturated with water during a great part of the year. The most common species in Europe, and also the most useful, is *P. sylvestris*; and the most common in North America is *P. Strobus*, which produces the white deal of commerce; and these species are found covering immense tracts of arid sand, in both hemispheres where scarcely anything else will grow. The species found in a wild state, in good soil in the south of Europe, are chiefly the *Picea pectinata*, and some of the varieties of the *Pinus Laricio*.

Very few species of Abietinæ have been found in a fossil state. Nevertheless, some remains of leaves, aments, and seeds of a species of *Pinus*, which Brongniart has named *P. Pseudo-Strobus*, have been found in some tertiary deposits at Armissau, near the Narbonne, in France, where also have been found the cones of eight other different species of *Pinus*, none of which now exist: the names given to these by Brongniart will be found in his *Histoire des Végétaux Fossiles*, and in the *Dictionnaire des Sciences Naturelles*, tom. lviii. p. 3. In the same tertiary deposits in England, and also in Germany, some of these cones, or some cones nearly resembling them, have also been found in a fossil state.

The distribution of the species and principal varieties of the Abietinæ is as follows:—

In Europe, 14 kinds: viz. *Pinus sylvestris*, *pumilio*, *Mughus*, *Laricio*, *Pallasiana*, *Pinus maritima*, *brütia*, *halapensis*, *Pinaster*, *Cembra*; *Abies excelsa*; *Picea pectinata*; *Larix europæa*.

In Europe and Asia, 5 kinds: viz. *Pinus halapensis*, *Pinaster*, *Cembra*; *Abies excelsa*; *Larix europæa*.

In Asia, 19 kinds: viz. *Pinus Massoniana*, *longifolia*, *sinensis*, *excelsa*, *Gerrardiana*, *halapensis*, *Pinaster*, *Cembra*; *Abies dumosa*, *orientalis*, *Smithiana* (*Morinda*), *excelsa*; *Picea Webbiana*, *Fudnow*; *Larix europæa*; *Cedrus Libani*, *Deodara*; *Cunninghania sinensis*; *Dammara orientalis*.

In Africa, 2 kinds: viz. *P. canariensis*, *Pinus*.

In Europe and Africa, 1 kind: viz. *Pinus Pinus*.

In North America, 40 kinds: viz. In the United States and Canada, 19 kinds: *Pinus Banksiana*, *laevis*, *resinosa*, *variabilis*, *Taeda*, *rigida*, *pungens*,

serotina, palustris, Ströbus; Abies alba, nigra, rubra, canadensis; Picea balsamifera, Fraseri; Larix pénédula, microcarpa. In North-West America and California, 15 kinds: Pinus Lambertiana, ponderosa, Sabina, Quercus (macrocarpa), muricata, tuberculata, radiata, monacola, insignis; Abies Menziesii, Douglasii; Picea nobilis, grandis, amabilis, bracteata. In Mexico, 6 kinds: Pinus patula, Tecote, leiophylla, Montezumae, Ilexedus; Picea religiosa. In Hispaniola, 1 kind: Pinus occidentalis.

In South America, 2 kinds: viz. Araucaria imbricata, brasiliensis.

In Australia, 1 kind: viz. Araucaria Cunninghamii.

In Polynesia, 2 kinds: viz. Araucaria excelsa; Dammara australis.

History. We find the pine and fir mentioned by most of the early Greek and Roman writers. Theophrastus speaks of the pines of Mount Ida, which possessed such a superabundance of resin, that the wood, bark, and even the roots, were completely saturated with it, and the tree was at length killed. In this state, it was used for making torches for sacred ceremonies; and hence, the word *torada* (a torch), was frequently applied as an epithet to the pine. Herodotus tells us that, when Miltiades, king of the Dolonci, was taken prisoner by the people of Lampacus, his friend Croesus, king of Lydia, procured his release, by threatening his conquerors, that if they did not release Miltiades, he (Croesus) would cut them down like pine trees. The people of Lampacus did not, at first, comprehend the force of this menace; but when they understood that the pine tree, when once cut down, never springs again from the root, they were terrified, and set Miltiades at liberty. The Latins, in allusion to this property of the pine, had a proverb, "*Pini in morem extirpare*," to indicate total destruction. The victors in the Isthmian games (which were instituted 1326 B. C.) were crowned with garlands of pine branches. The fruit of the pine was called by the Greeks *konos*, and *strobilos*; but the Romans called it *nux pinea*, and sometimes the apple of the pine. When Vatinius gave a show of gladiators to conciliate the people, by whom he was much hated, they pelted him with stones. The ediles made an order forbidding the people to throw anything but apples within the arena; and on this the people pelted Vatinius with the apples of the pine tree. The question was, then, whether this was to be considered as a defiance of the law; and the celebrated lawyer Cascellius being consulted, replied, "*Nux pinea, si in Vatinium missurus es, pomum est.*" The wood of the pine tree was employed by the Romans to form the funeral pile for burning the dead. The Romans also used the wood as shingles, to cover the roofs of houses, in the same manner as is done by the peasants of the Jews and the Vosges, and by several others, at the present day.

Pliny mentions several kinds of pine. The *pinaster*, he says, is quite different from the wild pine, and it grows, both on plains and mountains, to an astonishing height. The silver fir loves mountainous and cold places; and it throws out its branches, which are not very large, from the very root upwards, on every side. The spruce fir grows in the same manner, and is much sought after for building vessels; it is found on the highest mountains. The larch grows in the same situations as the fir, but its wood is better, almost incorruptible, red, and with a strong scent. The resin is abundant and glutinous, but it does not harden. "*Quinto generi situs idem, eadem facies: larix vocatur. Materies prestantior longè, incorrupta vis, mori contumax; rubens præterea, et odore arrior; plusculum huic erumpit liquoris, melleo colore, atque lentiore, nunquam durascentia.*" (Plin., lib. xvi.) Pliny also mentions that the fruit of *Pinus sylvestris*, which he calls *pityida*, was considered by the Romans as an excellent remedy for a cough.

The cones of pines were used by the Romans to flavour their wine, having been thrown by them into the wine vats, where they float on the surface, along with the scum that rises up from the bottom, as may be seen in the wine tanks attached to towns and farm-houses, in Tuscany and other parts of Italy, at the present day. Hence, the *thyrsus*, which is put into the hands of Bacchus, terminates in a pine cone. Pine cones, as pine-apples, were in

consequence which employed in Roman sculpture, and the latter appellation, pine-apple, has been transferred to the fruit of the ananas, from its resemblance in shape to the cone of the pine.

In more modern times, we find accounts of immense forests of pines and fir in different countries, but those of the north of Europe and North America are the most celebrated.

In Sweden and Norway are enormous forests, consisting almost entirely of the Scotch pine and the spruce fir; which, in many places, are nearly inaccessible. "If the reader," says Dr. Clarke, "will cast his eyes on the map of Sweden, and imagine the Gulf of Bothnia to be surrounded by one continuous unbroken forest, as ancient as the world, consisting principally of pine trees, with a few mingling specimens of birch and juniper, he will have a general and tolerably correct notion of the real appearance of the country."

(Frazz.) The manner of conveying the trees in these forests, over land, to the banks of a river or the sea, is thus noted by the traveller just mentioned: "At Helsingborg, some fir trees of astonishing height were conducted by wheel-rails to the water side. A separate vehicle was employed for each tree, drawn by horses which were driven by women. These long, white, and taper shafts of deal timber, divested of their bark, afforded the first specimens of the produce of those boundless forests of which we had, till then, formed no conception." The principal river in Sweden by which the pine and fir timber of that country is floated to the sea, is the Gotha, by which it is conveyed to Gottenburgh. The timber of Norway is floated down the Glomma to Christiania, whence it is called Christiania deal; down the Drammen to Dram; a seaport about twenty miles west of Christiania, whence it is called Dram deal; and down various other rivers.

In Prussia, Russia, and Poland, are also immense pine and fir forests, the timber of which is brought down the rivers, and shipped into the ports on the southern shores of the Baltic, whence it is called Baltic timber. The principal of these ports are Memel, Dantzic, Riga, and Petersburg. The river Memel being the principal channel by which the pine trees grown in the north of Prussia reach the sea at the town of that name, the timber they produce is known by the name of Memel timber. In the hills, or lowlands, of this country, amber is found in greater abundance than in any other part of the world; and it is now generally supposed that this substance is the resinous matter of decayed pines, changed by the length of time it has been buried in the earth. (See *Jam. Jour.*, July, 1837, p. 173.) The timber shipped at Memel comes principally from the estates of Prince Radzivil, in Polish Prussia, and it is always much more abundant than that shipped at any other port of the Baltic; that of Dantzic is of better quality, and it is floated down the Bug and the Vistula, from the forests of West Prussia and Poland. The best Baltic timber, however, is that of Riga; and it is the principal kind used for the masts, both of the British and French navies. "The mast trade," says McCulloch, "is very extensive. The burghers of Riga send persons who are called mast brokers into the provinces, to mark the trees, which are purchased standing. They grow mostly in the districts which border on the Dnieper; and are sent up that river to a landing-place, whence they are transported 30 versts (about 23 English miles) to the Dwina; where being formed into rafts of from 50 to 100 pieces each, they descend the stream to Riga. The tree which produces the longest masts is the Scotch pine. The pieces, which are from 16 in. to 25 in. in diameter, are called masts; and those under these dimensions, spars, or in England Norway masts, because Norway exports no trees of more than 18 in. in diameter. Great skill is required in distinguishing those masts which are sound from those which are in the least degree internally decayed. They are usually from 70 ft. to 80 ft. in length." (Dict. of Com.)

The pine timber shipped at Petersburg is at present brought from a great distance to the interior, all the large timber of the comparatively near forests having been long since cut down. A Russian proprietor wishing to

dispose of the timber on his property, having completed a bargain with the Petersburg merchant, sets his peasantry to work in picking out, cutting down, and dragging the trees from the forest to the lakes and rivers. This work generally takes place during the winter months, in order that every thing may be ready for floating the timber to Petersburg as soon as the ice on the rivers and lakes breaks up. As the ground is generally covered several feet deep with snow, and the trees judged to be sufficiently large and sound for the foreign market lie widely apart, the workmen and others employed in picking them out are compelled to wear snow shoes, to prevent them from sinking in the snow. When the trees are found, they are cut down with hatchets, and the head and branches lopped off. The trunk is then stripped of its bark, and a circular notch is cut round the narrow end of it, in which to fix the rope by which the horses are to drag the trunk along; and a hole is made at the other end for a handspike, to steer the log over the many obstacles which lie in its way. Many of these trees are 70 ft. in length, and of proportionate diameter; and they are drawn by from 5 to 9 horses each, "yoked in a straight line one before another, as the intricate narrow paths in the wood will not permit of their going in any other way. One man mounts upon the leading horse, and another upon the middle one, while others support and guide with handspikes the large and distant end of the tree, to raise it over the elevations of the snow, and make it glide smoothly along. The conveyance of these large trees, the long line of the horses, and the number of boors accompanying them through the forests, and across the fields of snow, present an appearance very interesting." (*Hovison in Ed. Phil. Jour.*, xii, p. 65.) In many cases, the trees are brought above 1000 versts (nearly 1000 English miles) before they are delivered to the merchant; and they generally remain under his care "another winter, to be shaped and fitted for exportation, in such a manner as to take up as little room as possible on shipboard;" so that the Russian timber does not reach the foreign consumer till two years after it is cut down. When the trees are delivered to the merchant they are carefully examined by him, and the nobleman, or his overseer, to ascertain their soundness; and, for this purpose, a hatchet is struck several times against them, and by the sound arising from the strokes they judge of the soundness of the tree. The trees rejected, which are called *braks*, are in the proportion of 1 in 10. The trunks are formed into rafts, and floated down the rivers by the current; but on the lakes they are propelled by sails or paddles, or, where practicable, by horses; the boors who guide the raft, living in a wooden hut constructed on it. Most of the pine timber sent to Petersburg, lies beyond the Biel Ozer, or White Lake, the waters of which, and of the Onega Lake, it has to traverse, besides passing down several rivers, before it reaches Petersburg. "Across these great lakes, resembling seas in extent, the navigation is at times difficult and dangerous. Storms and sudden gales of wind frequently occur, driving the vessels and timber rafts from the sides into the middle of the lakes, out of sight of land, and often proving destructive to them and to their crews." In order to prevent such accidents, Peter the Great began the Ladoga Canal, along which the rafts are conveyed with perfect safety, to the river Neva, the stream of which carries them down to Petersburg, where they remain in the timber-yard of the merchant till they are ready to be floated down to Cronstadt for foreign exportation." (*Ibid.*, p. 70.)

In Germany there are extensive forests of pine and fir trees; and the following description of the rafts of timber on the Rhine will give an idea of the mode by which these trees are conveyed down that river to the sea:— "A little below Andernach, the village of Namedy appears on the left bank, under a wooded mountain. The Rhine here forms a little bay, where the pilots are accustomed to unite together the small rafts of timber floated down the tributary rivers into the Rhine, and to construct enormous boats, which are navigated to Dortrecht (Dort), and there sold. These machines have the appearance of floating villages, each composed of twelve or fifteen little wooden huts, on a large platform of oak and deal timber. They

are frequently 800 ft. or 900 ft. long, and 60 ft. or 70 ft. in breadth. The towers and workmen sometimes amount to 700 or 800, superintended by pilots, and a proprietor, whose habitation is superior in size and elegance to the rest. The raft is composed of several layers of trees, placed one on another, and tied together: a large raft draws not less than 6 ft. or 7 ft. of water. Several smaller rafts are attached to the large one, besides a string of boats, loaded with anchors and cables, and used for the purposes of sounding the river, and going on shore." (*An Autumn near the Rhine.*) Every article of provision for the workmen is carried on board these rafts, together with live pigs, poultry, &c.

In Austria there are immense forests of pines and firs, particularly in the Alpine districts, and in the Tyrol; and the timber is in many instances conveyed several miles before a stream is met with, capable of floating it to a large river or lake, whence it is to be conveyed to the sea. In these cases, semicircular troughs called slides are constructed, formed of six or eight fir trees, placed side by side, and smoothed by stripping off the bark. These slides are made in such a direction, as always to preserve nearly the same slope; and while they require in some places to pass through projecting rocks in tunnels, in others they are carried over ravines on lofty piers, formed of tall trees. The first slide of this kind is supposed to have been that of Alpnach, of which some notice will be found in the succeeding paragraph. These slides are chiefly made use of in winter, at which time they are rendered more slippery, by pouring water down them, which freezes immediately. (*See Handbook for Travellers in Southern Germany.*)

In *Switzerland*, on the Alps, are extensive pine and fir forests; though but little use can be made of the timber of most of them, except for local purposes, from the great difficulty of transporting the trees to the sea, or to a navigable river. In the year 1810, when the price of Baltic timber had attained its greatest height, a stupendous, and at the same time successful, effort was made by an enterprising engineer to convey the timber of Mount Pilate to the Lake of Lucerne, whence it might be floated down the Rhone to the sea. M. Rupp conceived the idea of making an inclined plane, which should extend the whole distance, from the top of the mountain to the Lake of Lucerne; that is, above eight English miles. This extraordinary contrivance (the construction of which occupied eighteen months, and which was completed in 1812) was called the Slide of Alpnach, and consisted of a trough, formed of 25,000 pine trees, 6 ft. broad, and from 3 ft. to 6 ft. deep. Its length was 4400 English feet; and, of course, to preserve its regular slope, it had to be conducted over the summits of rocks, along their sides, underground, and over deep gorges, where it was sustained by scaffoldings. The slide was kept constantly moist, and the trees descended by it into the lake with extraordinary rapidity. The larger pines, which were about 100 ft. long, ran through the whole space of eight miles and a third, in about six minutes. A gentleman who saw this great work stated, "that such was the velocity with which a tree of the largest size passed any given point, that he could only strike it once with a stick as it rushed by, however quickly he attempted to repeat the blow." The speculation, however, did not answer long; and as soon as the markets of the Baltic were opened by the peace, the Slide of Alpnach was suffered to fall into ruin. (*See Edin. Phil. Journ., 1820.*)

The north of England and some parts of Scotland and Ireland, appear to have been anciently nearly covered with pine forests. The immense tract of country afterwards called Hatfield Chase was once an almost impenetrable forest; but the trees in it were partly cut down, and partly burnt by the Romans, not only to make a road through the country, but to drive the Britons from their fastnesses. Fallen forests, if the trees be not removed, soon become peat bogs; by the fallen trees stagnating the water, and giving rise to the growth of the *Sphagnum palustre*, and other mosses and aquatic plants. These continue growing on the surface, and decaying at their lower extremities, till the surface of the sphagnum has risen so

high above the natural surface as to throw off the rain, instead of retaining it. The sphagnum and other aquatics then die, and form a surface adapted for mosses, which delight in dry soil; and for other plants, the light seeds of which may be floating in the atmosphere, or carried thither by birds. The Forest of Hatfield, containing 180,000 acres, underwent this process, and remained a complete waste, only inhabited by red deer, till, in the time of Charles I., it was sold to Sir Cornelius Vermuiden, a Dutchman, who drained it, and brought it into use. When this forest was drained, many trees of extraordinary size were found, and, among others, the oak, already mentioned, p. 1775. The pine and fir trees were, however, most abundant, and bore marks of having been burnt, some quite through, and others only on one side. Some had been chopped and squared, some bored, and others half split, with large wooden wedges and stones in them, and broken axe-heads, something like the sacrificing axes in shape. (See *Trans. Roy. Soc.* for 1701.) In Scotland, one of the principal pine forests is that of Rothiemurchus, which spreads over the glens and valleys of the Grampian Hills. The timber in this forest is generally floated down the Spey; and, when, from a long season of drought or any other cause, there is any difficulty in getting it down to the river, the workmen collect the trees into a suitable dell; and, having built up a temporary dam, wait the coming of a flood, which in a country of such varied surface is no rare occurrence. As soon as the temporary dam is full of water, they break down the boundary; and the liberated waters bursting from their confinement, carry the trees with them, thundering down the Spey. The trees grown in the Forest of Rannoch, in Perthshire, are floated down the Tay, and the remains of this forest may be traced across the country, by stumps and occasional trees, to the woods of Mar in Aberdeenshire, the timber in which is floated down the Dee. In the valley of the Dee is an extensive peat moss, or bog, in which pine is the principal timber found submerged; and such is the durability of this wood, that while the bog timber of the birch is often found reduced to a pulp, and the oak cracks into splinters as it dries, the heart of the pine remains fresh, embalmed in its own turpentine: it is quite elastic, and is used by the country people instead of candles. In the north of Ireland, as late as the sixteenth and seventeenth centuries, an extensive forest of pine and fir appears to have extended through the counties of Donegal and Tyrone; and, according to Mackay (*Fl. Hib.*, p. 259.), trunks of very large dimensions of the Scotch pine are often found in bogs, sufficiently fresh for roofing houses. "The resinous roots," he adds, "are sold in Dublin as fire wood, and are used by the peasantry in the west of Ireland in lieu of candles."

In North America, both in the United States and Canada, are the most extensive pine forests in the world; and the most gigantic specimens of *Abies* that are known to exist, some of the firs found by Douglas in California growing to the height of from 150 ft. to 200 ft. In Canada, from the summit of the ridge extending from the shores of Labrador westward across the country to the marshes near Lake Winnipeg, and on the south side of the great estuary of the St. Lawrence, as far as the boundary of the United States, the land, before it began to be cleared by the European settlers, was covered with one immense forest of pines and firs; and on the south of the St. Lawrence, the forest reached down to the water's edge along the whole shore, and even covered the islands. The Canadian lumber sent to England is principally from New Brunswick; and in 1824 it amounted in value to half a million sterling. The following account of the mode of cutting the timber in the back woods of Canada is abridged from *M. Gregory's Sketches of the Maritime Colonies of British America*, published in 1822. Several persons form themselves into what is called "a lumbering party," under the command of a "master lumberer," who manages the whole, the necessary supplies of provisions, clothing, &c., are generally supplied on credit by merchants, who are to receive payment out of the stock of timber sent down the rivers, the following summer. The people then proceed into the woods, and select a place for their encampment, near a stream of water, here

they build a log-rat, forming a pit or cellar below it to preserve those things which are liable to be injured by the frost. The cold is so intense that they are obliged to keep up a constant fire night and day, and they drink enormous quantities of rum, generally without water. When they work, they divide into three gangs: one of which cuts down the trees, another hews them, and the third is employed with oxen in dragging the logs to the nearest stream. Here they lie till the snow begins to dissolve in April or May, when the rivers swell, or, according to the lumberers' phrase, 'the freshets come down.' At this time all the timber cut during winter is thrown into the water, and floated down till the river becomes sufficiently wide to make the whole into one or more rafts. The water at this period is exceedingly cold; yet for weeks the lumberers are in it from morning till night, and it is seldom less than a month or six weeks from the time that floating the timber down the streams commences, until the rafts are delivered to the merchants. No course of life can undermine the constitution more than that of a lumberer and raftsman. The winter snow and frost, although severe, are nothing to endure, in comparison with the extreme coldness of the snow water of the freshets; in which the lumberer is, day after day, wet up to the middle, and often immersed from head to foot. The lumberers of New Brunswick, and those who cut down timber in the United States, take great care to select trees of a proper size. Mr. M'Gregor states that not one tree in 10,000, in the woods, is fit for the purposes of commerce. In the United States the forests of pines and firs, when they occur on poor, dry, sandy plains, where broad-leaved trees will not grow, are called pine barrens, and they extend over a very considerable portion of the southern states, as far as North Carolina. "Upwards of 500 miles of our journey," says Captain Hall, "lay through these desolate forests, and I have therefore thought it worth while to give a sketch (fig. 2004.), which is sufficiently characteristic of these singular regions.



Occasional villages (fig. 2005.) gave some relief to the tedium of this part of the journey, and wheresoever a stream occurred, the fertility of the adjacent lands was more grateful to the eye than I can find words to describe. Once or twice, in travelling through the state of Georgia, we came to high lands, from which we could look over the vast ocean of trees, stretching without a break in every direction as far as the eye could reach, and I remember upon one of these occasions, thinking that I had never before had a full conception of what the word forest meant. (Hall's Sketches of Canada, London Edition, No. xxiii.) The pines in the United States which furnish timber for exportation are, according to P. A. Michx., P. mitis (the yellow pine), P. strobus (the white or Weymouth pine), and P. australis (the long-leaved pine.) Of these, the wood of P. mitis is called, in the English markets,



the New York pine, and it is sold at a lower price than that of *P. australis*, but higher than that of *P. Ströbus*. The long-leaved pine is the principal tree in the extensive pine barrens of the southern states. The timber of it is sent to England, principally from Savannah in Georgia, in planks called "ranging timbers," which are from 15 ft. long, and 10 in. or 12 in. broad. At Liverpool it is called Georgia pitch pine, and is sold 25 or 30 per cent higher than any other pine imported from the United States. The timber of *P. Ströbus* is, however, that most generally imported into England from the United States; and the best is brought from the district of Maine, particularly from the banks of the river Kennebeck. The persons engaged in felling this timber are generally emigrants from New Hampshire. "In the summer they unite in small companies, and traverse these vast solitudes in every direction, to ascertain the places in which the pines abound. After cutting the grass and converting it into hay for the nourishment of the cattle to be employed in their labour, they return home. In the beginning of winter they enter the forests again, establish themselves in huts covered with the bark of the canoe birch, or arbor vitæ; and, though the cold is so intense that the mercury sometimes remains for several weeks from 40° to 50° Fahr. below the freezing point, they persevere in their labour." (*Michx. North Amer. Syl.* iii. p. 167.) When the trees are felled they cut them into logs of from 14 ft. to 18 ft. long; and, by means of their cattle, drag them to the river, where they stamp them as a mark of property, and then roll them on its frozen surface, to remain till the breaking up of the ice enables them to float down the current. All the logs that come down the Kennebeck are stopped at Winslow, 120 miles from the sea; where each person selects his own, and forms them into rafts with the intention of selling them to the proprietors of the numerous saw mills between that place and the sea; or of having them sawn into planks for his own benefit, at the price of half, or even three quarters of the product in abundant years. The logs that are not sawn the first year, adds Michaux, are attacked by large worms, which form holes about 2 lines in diameter, in every direction; but, if stripped of their bark, they will remain uninjured for thirty years. The district of Maine furnishes three fourths of all the white pine exported from the United States, including what is brought from New Hampshire, by the Merimack, to Boston. That cut on the shores of Lake Champlain is carried to Quebec by the Sorel and the St. Lawrence. "What is furnished by the southern part of the lake is sawn at Skeensborough, transported 70 miles in the winter on sledges to Albany; and, with all the 'lumber' of North River,

brought down in the spring to New York, in sloops of 80 or 100 tons, to be afterwards exported to Europe and the West Indies." (*Michx.*) Timber of the white pine is also floated down the Delaware and Susquehanna to Philadelphia, and down the Ohio and Alleghany to New Orleans. Boston is the principal emporium of pine timber in the northern states; and the timber exported from that city is generally divided into what are called Albany, or common, boards, which are frequently deformed with knots; and the clear, or picked, boards, which are called at Philadelphia white pine panels.

The literary history of the pine and fir tribe, in modern times, may be said to commence about the middle of the sixteenth century, when Belon published his work *De Arboribus Coniferis, Resiniferis, &c.*, already noticed, p. 187. Forests of pines and firs were at that time much more common throughout Europe than they are at the present day; and the attention of planters seems not to have been drawn to the raising of pine and fir plantations, till the comparative scarcity of pine timber of large dimensions, which occurred about the end of the seventeenth century. Evelyn, and afterwards Miller, in England, and Buffon and Du Hamel in France, first directed attention to the subject. About the middle of the last century, the Baron Tschoudy translated into French what Miller had written on the pine; he also made a great many experiments himself; and was the first to introduce the practice of grafting the pine and fir tribe. In the beginning of the present century, the first volume of Lambert's *Genus Pinus*, appeared in England, and it has been since followed by two others; in 1810, Michaux's *Arbres Forêtiers de l'Amérique*, and in 1826, the *Mémoires sur les Conifères*, of M. Richard, were printed in France; and these works, as far as respects botanical science, are by far the best yet published on the subject of which they treat. In Delamarre's *Traité Pratique de la Culture des Pins*, 3d edit., published in 1834, will be found an alphabetical catalogue of 43 authors, who have written, more or less, on the culture of the pine in France; but the works more particularly worth referring to, in addition to those above mentioned, are the *Nouveau Du Hamel*, and the *Flora Americana Septentrionalis* of Pursh.

Several sorts of pines and firs appear to have been known in England in the time of Gerard and Parkinson; and afterwards Ray and Evelyn refer to gardens containing particular species. It had not then been common to form plantations of the pine as a useful tree; for Evelyn mentions as remarkable, that "a northern gentleman" had informed him that the pine was abundantly planted in Northumberland for timber. Evelyn mentions ten several sorts as then in English gardens; including the cedar, and the larch, the pinaster, the *Pinus Teda*, the silver fir, the spruce, and one or two other species or varieties of doubtful identity. In the London nurserymen's *Catalogue* of 1730, (mentioned p. 60,) about the same number are enumerated as being then propagated for sale. In Miller's time, collections of pines and firs appear to have been first made by some of the principal landed gentlemen. Among the oldest of these collections was that at Woburn Abbey, where the park, at the beginning of the present century, contained some immense silver firs, that have since been cut down on account of their age. At Whitton, an excellent collection was made, between 1720 and 1730, by Archibald Duke of Argyll; some fine specimens of which, and especially of the cedars, pinasters, Weymouth pines, and hemlock spruces, still remain, and continue to grow vigorously. According to the *Hortus Kewensis*, the *Pinus Cembra* was first planted at Whitton; and the original tree, which still exists, was, in July, 1837, 50 ft. high, with a trunk 1 ft. 6 in. in diameter. Between 1750 and 1760, Peter Collinson made a collection of all the rarest pines and firs that could be procured in his time, in his grounds at Mill Hill; and several of these trees, particularly *P. Cembra*, *P. Pinæa*, and some of the cedars and spruces, still remain. A collection of pines and firs was made at Syon about the same period; and, when Kew Gardens were formed in 1760, as many species were

planted there as could be procured, and the collection has since received several additions from time to time. The best collections of old trees in the immediate neighbourhood of London, now (1837) existing, are those at Kew and Syon; but the most complete collection, where the plants are of a considerable size, in England, and doubtless in the world, is that in the pinetum at Dropmore, near Windsor, commenced by the late Lord Grenville, about 1810, and now (1837) amounting to above 100 kinds. This fine collection is kept up with the greatest care by Lady Grenville, and every new species or variety is added, as soon as it can be procured. All the sorts of *Abietinae* that are in the country are in the garden of the London Horticultural Society; but the plants there are, for the most part, of small size.

Pinetums, by which are to be understood collections of the *Abietinae* planted by themselves, and without the intermixture of broad-leaved trees, have, since the commencement of that at Dropmore, been formed by several landed proprietors in different parts of the country; stimulated, no doubt, by the extraordinary beauty and interest of the Dropmore pinetum, and by the number of new and beautiful species of pines and firs which have been introduced from California and the Himalayas. Many persons have also made collections of the *Abietinae*, and planted them in ornamental grounds along with broad-leaved trees. In England, pinetums, or collections, have been made by J. T. Brooks, Esq., at Filbrick House, in Bedfordshire, where there are 100 sorts; by Sir Charles Monck, at Belsay in Northumberland; by Sir Charles Lemon, at Carelew in Cornwall; by William Harrison, Esq., at Cheahunt; by the Duke of Devonshire, at Chatsworth; by the Duke of Bedford, at Woburn Abbey; by W. A. Baker, Esq., at Bayfordbury, in Hertfordshire; by F. Perkins, Esq., Chipstead Place, Kent; by Lord Arundel, at Wardour Castle; by the Earl of Caermarvon, at Highclere; by William Wells, Esq., at Redleaf; and by several others. In Scotland, the first collection of *Abietinae* was formed at Methven Castle, on the estate of Robert Smith, Esq. by the zeal of his able and intelligent land steward, Mr. Thomas Bishop; one has been formed at Posso, in Peebleshire (a place which has long been celebrated for its trees, see page 98.), which it is believed contains a greater number of species than any other in Scotland, though the plants are all young. At Haddo House, in Aberdeenshire, the Earl of Aberdeen has formed a collection, and spares no expense in procuring plants of all the new sorts as they are introduced. At Ballendalloch, Morayshire, George Macpherson Grant, Esq., commenced a pinetum in 1836, to which every new sort is added as soon as it can be procured. The soil and climate of Ballendalloch seem to be particularly adapted for the *Abietinae*, as will appear by an account of the growth of some of the trees there, which we shall give in a future page; so that we have no doubt of this pinetum becoming in a few years one of the very first in Scotland. Collections of more or less extent have also been formed at Lowhill, in Fifeshire, the property of C. Craigie Halkett, Esq.; at Hopetoun House, near Edinburgh, the seat of the Earl of Hopetoun, where there is the largest tree of *Abies Smithiana* in Britain; at Oxenford Castle, Edinburghshire, the seat of Sir John Dalrymple McGill; and at Melville House, Fifeshire, the seat of the Earl of Leven. For this account of the pinetums of Scotland, we are indebted to Mr. Lawson, the eminent seedman of Edinburgh, whose communication on the subject will be found at length in the *Gard. Mag.*, vol. xiii. In Ireland, the first pinetum formed was that of the Glasnevin Garden, which was commenced in 1797; and, about the same time, a number of species were planted at Oriel Temple, in the county of Louth, by the late Lord Oriel. Both collections continue to receive additions; Lord Viscount Ferrard, the son and successor of Lord Oriel, being, like his father, much attached to trees. In Trinity College Botanic Garden, in Dublin, a pinetum was commenced in 1809; which, like that at Glasnevin, has since received the addition of most of the new species. At Tittour, Mount Kennedy, in the county of Wicklow, a collection has been formed, and great attention paid to the culture of the pines and firs; by John Nuttall, Esq.; and a collection has been commenced in the Dublin Botanic

Garden. For these notices of pinetums in Ireland, we are indebted to Mr. Nuttall, Mr. Nevin, and Mr. Mackay, whose respective communications on the subject will be found in the *Gardener's Magazine*, vol. xiii.

Among nurserymen, the most complete collection in England is in the arbo-retum of Messrs. Loddiges; and next, as regards the number of rare species, are the collections of young plants grown for sale in the nurseries of Messrs. Brown at Slough, of Messrs. Osborne at Fulham, and of Messrs. Lee at Hammer-smith. The best nursery collections in Scotland are, Mr. Lawson's at Edinburgh, and Mr. Roy's at Aberdeen; and the best in Ireland, that of Mr. Hodgkin at Dunganston. Mr. Charlwood is the principal British nurseryman for seeds of rare Abietinæ, which he imports annually from America.

In France, the first collection of Abietinæ worthy of notice appears to have been that of the celebrated Du Hamel, on his estate at Moneau, noticed p. 140. Since that period, several species have been sent from America by Michaux, or collected by the government gardeners, and planted in the grounds of the Trimon, at Versailles, and in the Bois de Boulogne. The Baron Tschoudy had a collection on his estate at Colombey; and M. Delamarre had extensive plantations at Vieil-Harcourt, in the department of the Maine, which he thought of so much importance, that he bequeathed them, together with his treatise on the subject (*Traité Pratique de la Culture des Pins*), to the French government. M. Vilmorin, the joint author with Michaux, of notes to the edition of Delamarre's work, published in 1831, has paid great attention to the subject of pines, and has tried many species on his estate at Barres, where he has collected all the species which he could procure, and planted them singly, or in groups, or masses; the sorts most nearly allied being placed adjoining to each other, with a view to the study of the species and varieties by botanists, when the plants shall be grown up. In this pinetum, M. Vilmorin has been particularly assiduous in procuring and planting all the varieties of the species most esteemed in Europe for their timber: such as *P. sylvestris*, *P. Laricio*, *P. Pinaster*, &c. M. Puvis, who has given an account of M. Vilmorin's plantations, in his work entitled *De l'Agriculture du Gâtinais*, &c., states that the pinetum at Barres is at all times open to the inspection and study of botanists and cultivators. Perhaps the most remarkable fact connected with the pine and fir tribe in France, is the circumstance of grafting having been performed on a large scale on the pine trees in the Forest of Fontainebleau, belonging to government. Here M. De Larminat, the conservator of the forest, had grafted many thousands of *P. Laricio* on plants of *Pinus sylvestris*, which have become fine trees; and the practice is annually continued. In the French nurseries, the best collections are those of M. Vilmorin and M. Soulange-Bodin. In Germany, there are collections of pines in the different botanic gardens; and the most complete is that in the Berlin Garden: but even this is surpassed in number of species by the collection of Messrs. Boeth, in the Floetbeck Nurseries.

Poetical, mythological, and legendary Allusions. The gloomy grandeur of the pine and fir tribe, their upright growth and great height, the regularity of their forms, and the murmuring of the winds through their stiff leaves and rigid branches, have made them favourites with the poets from the remotest antiquity. The Egyptians considered the pine as an emblem of the soul. Homer describes the residence of the Cyclops as "brown with o'erarching pine;" and other Greek poets tell us that the nymph Pitys, who was beloved by Pan, having slighted the passion of Boreas, was dashed by him against a rock, when the pitying Pan caused a pine tree to spring from her remains. Marsyas, who challenged Apollo to a trial of skill as a musician, and was afterwards flayed alive by that god for his presumption, was fastened to a pine tree, and left there to perish. He is often represented, in ancient sculptures, as tied with his hands behind his back to a lofty pine; while Apollo stands before him holding his lyre. Some authors, however, say that the place of Marsyas's suffering was against a plane tree. (See p. 2038.) The Roman poets frequently mention the pine. Ovid tells us that Polyphemus

carried with him a lofty pine tree, by way of walkingstick; that Ceres bore a flaming pine tree, plucked from Mount Etna, in each hand, during her search for her daughter Proserpine; and that Cybele, when her favourite Atys was about to destroy himself, changed him into a pine tree, and hence that tree was considered sacred to Cybele. He adds that a grove of sacred pines was among the trees moved by the music of Orpheus. Ovid also gives us the history of Sciron, or Cercyon, the pine-bender, a notorious robber, whose habit was, when he had taken a prisoner, to bend two pine trees, and to tie one of the prisoner's hands to each, and then to let the trees fly back, when the unfortunate traveller was torn asunder. This cruel monster was destroyed by Theseus. Virgil tells us that the ships of Æneas, which were afterwards changed into nymphs, were made of pine trees sacred to Cybele. He also alludes to the mournful sounds produced among the pine branches by the wind, and calls them the singing pines :

"The pines of Masalus were heard to mourn,
And sounds of woe along the groves were borne."

The cones of the pine were sometimes sacrificed to Bacchus, because they were put into wine to give it a flavour; and sometimes to Esculapius, because their odour, being balsamic, was thought excellent for asthma.

The pine tree is frequently mentioned by the elder British poets, principally as affording an object of comparison for tall and stately beauty, or for dark and gloomy grandeur. One of the finest allusions to the pine is by Milton, in his splendid description of Satan, in the first book of the *Paradise Lost* :—

"His spear, to equal which the tallest pine,
Hewn on Norwegian hills, to be the mast
Of some great admiral, were but a wand."

Milton also says :—

"His graces, ye winds, that from four quarters blow,
Breathe soft or loud; and wave your tops, ye pines,
With every plant, in sign of worship wave."

Among the more modern poets, perhaps the most beautiful lines relating to the pine are those of Barry Cornwall. Speaking of Polyphemus, he says, —

— "Mighty tears then fill'd
His solitary eye, — and with such noise
As the rough winds of autumn make when they
Pass o'er a forest, and bend down the pines,
The giant sigh'd."

Death of Acis.

— "Here dark trees
Funereal (cypress, yew, and shadowy pine
And spiky cedar) clustered; and at night
Shook from their melancholy boughs sounds
And sighs like death."

Ibid.

Leigh Hunt has also some beautiful lines on the pine tree :—

"And then there led by me a rush of air
That stirred up all the other foliage there,
Flinging the solitude with panting tongue;
At which the pines woke up into their songs,
Shaking their choral locks."

Hunt's Follage: Evergreens, p. 24

"And 'midst the flowers, turf'd round beneath the shade
Of stretching pines, a bubbling fountain play'd;
And 'twixt the shafts you saw the water bright,
Which through the darksome tops gimmer'd with showering light."

Story of Bambi, canto iii.

Shelley thus describes one of the conflagrations in the Norway forests :—

"As the Norway woodman queets,
In the depth of piny dells,
One light flame among the brakes,
With the homestead forest shakes,
And the mighty krunks are torn
By the fire thus lowly born,
The spark beneath his feet is dead,
He starts across the flames if led,
Howling through the darken'd sky
With myriad tongues, victoriously."

Properties and Uses. The native forests of *Abiétinæ* are observed to be warmer in winter than those of any other evergreen tree in the same climate. They consequently afford excellent shelter for wild animals of every description, and one of the best substitutes for a house for man. In the north of Europe, this is more particularly applicable to the forests of spruce fir, which form so dense a covering as almost to exclude heat in summer, and cold in winter. The pine and fir tribe, in a living state, with the exception of the larch (that tree having tender foliage), afford food to but few insects; but the seeds are greedily devoured by the squirrel and other animals, and by some birds. In civilised society, the wood of the pine and fir tribe is in universal use, and forms one of the most important articles of European and American commerce. No other tree produces timber at once so long and so straight; and so light, and yet so strong and stiff; it is therefore peculiarly fitted for almost all the purposes of civil architecture, and for some peculiar uses in the construction of ships. Masts are every where made of it, where it can be pro-

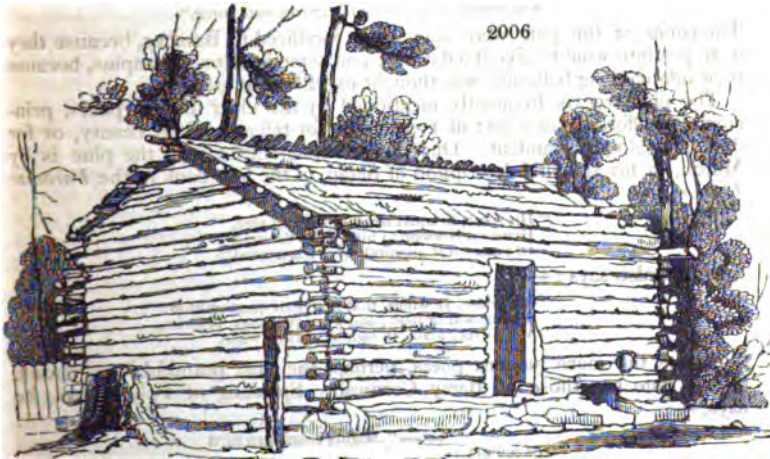

cured of sufficient size; and the yellow deal of Europe, which is produced by the *Pinus sylvéstris*; the white deal of Norway, which is produced by the *Abies excélsa*; and the white pine wood of America, which is the *Pinus Stròbus*, are used throughout the civilised world in building and fitting up houses, in the construction of machinery, in furniture, and for an endless number of purposes. Log-houses (see *fig.* 2006.) are more conveniently made of trunks of the pine and fir tribe than of any other tree, on account of their straightness, and the slight degree in which they taper.

For the same reason, also, the worm fence of America (*fig.* 2007.), and the wooden fence of Sweden and Norway (*fig.* 2008.), are always made of pine or fir wood, when it can be obtained. In Russia, Poland, and other parts of the north of Europe, and also in the interior of North America, roads are formed over marshy ground by laying down the trunks of pine trees, side by side, and close together, across the line of road. In the latter country, these are called *co duroy roads*. In some parts of the towns of Russia, and particularly in Moscow and Kiow, regularly squared planks are laid down instead of rough trunks; and, both in Moscow and Vienna, the courts of some of the larger

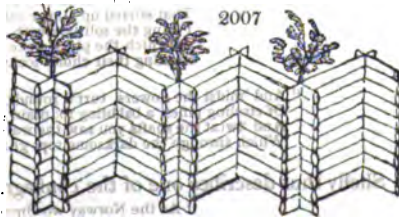

mansions are paved with pieces of the trunk of about 18 in. in length, set side by side, and beaten down till they form a level surface, in the same way as is done when stones are used for a similar purpose. This wood, from the quantity of resinous matter which it contains, is very combustible, and makes excellent fuel; and, in the Highlands of Scotland, splinters of it were formerly used as a substitute for candles; as they still are in some parts of Ire-



2008

land, and in Sweden, Norway, Russia, and some parts of North America. In the latter country, according to Michaux, the inhabitants, in some parts of the interior, split the red wood of the pine into pieces about the thickness of a finger, which they call candle wood, and burn instead of candles; but, on account of the disagreeable black smoke which these pine candles produce, they are generally burned in the chimney corner, upon a flat stone or iron. The branches, more especially those of the genera *Abies* and *Picea*, from their frond-like forms, are well adapted for protecting plants during winter, either in the open ground, or trained against walls. In Switzerland and Norway, they are used as food for cattle. The roots, and also the trunks, produce turpentine, resin, tar, pitch, and lampblack. The bark of the larch, and of several other species, is, or may be, used in tanning. *P. Pinea* affords a kernel which is valued for the dessert in Italy and Greece; the kernel of *P. Cembra* is equally prized in some parts of Switzerland. *P. Lambertiana* not only affords eatable nuts, but a substance which is used by the natives of California as sugar. The kernels of the araucarias are highly prized as food in Brazil; and, doubtless, those of most of the other species might be eaten, if freed from their resinous matter by roasting. A decoction of the tops of the spruce fir is employed for flavouring spruce beer; and from the inner bark, dried and ground, a kind of meal is produced, which, in the north of Europe, in times of scarcity, is mixed with that of rye and oats, and made into bread. The cones of pines and firs, thrown into wine or beer, have a tendency to check fermentation, and also to communicate an agreeable resinous flavour. The larch exudes a glutinous matter, which, in some countries, is collected by the natives, and used as a substitute for manna; and the same tree produces a fungus which is used medicinally in Siberia. The more hardy kinds of the pine and fir tribe are much valued in plantations as a shelter to others of a more tender kind; more especially the oak, which, as we have seen p. 1803., is protected in the government plantations, even in the south of England, for a number of years, by the Scotch pine. Few trees are so well adapted as the pine and fir tribe for covering immense tracts of barren, or even drifting, sands, with wood; either by directly sowing the seeds on the sand; or by sowing them among plants of broom or creeping grasses previously raised on drifting surfaces, in order to fix the sand and shelter the young pines. This practice has been carried to a great extent in France, on the shores of the Gulf of Gascony; where it was commenced in 1789, by Bremon tier, an engineer connected with the national forests and waste lands of France. (See De Candolle's *Physiologie Végétale*, tom. iii. p. 1236., and the history of *P. Pinaster*, in a future page.) Wherever waste ground is covered with heath alone, a forest of pines may easily be created by merely sowing the seeds among the heath. This is a remarkably simple mode of raising a forest of trees, but it scarcely applies to ground covered with any other description of herbage than heath, or to any other kinds of timber trees than those of the pine and fir tribe, and the birch. The poplar and the willow might be treated in the same manner, but the seeds of these can seldom be procured in sufficient quantity.

The most useful species of *Abietinae*, at least in Europe, in the existing state of the pine and fir forests, and of arboriculture, is unquestionably the

Scotch pine; next to it is the larch, and after that the spruce fir. When some of the newly introduced American and Himalayan species are better known, perhaps they may rank as high as, or higher than, these European ones; but at present, with the exception of *Abies Douglassii*, which promises to be a rapid-growing species, what they are likely ultimately to become in Britain must necessarily be only matter of conjecture.

Resinous substances have been extracted from the pine and fir tribe, since the days of Theophrastus, who has given (book ix. c. 10.) a very good account of the process, which has been copied, with very little variation, by all authors who have written on the subject, up to the time of Du Hamel; and which, as Dr. Clarke observes, corresponds so well with the modern practice in the north of Europe, that there is not the smallest difference between a tar-work in the forests of Westro-Bothnia, and one in those of ancient Greece. Du Hamel's account forms the groundwork of an article on the resinous productions of the pine and fir tribe by Dr. Maton, published in Lambert's *Genus Pinus*, vol. ii.; but the most complete treatise on the subject is in the *Dictionnaire des Eaux et Forêts*, where the German practices are given from Hartig and Burgsdorf; and those of France, Switzerland, and Italy, from modern authors of the respective countries. From these and other sources we shall here give what is general to all the *Abiétinæ*; and under the particular genera and species we shall insert the details for extracting and manufacturing the products peculiar to each. These products are various; but they may be all divided into two classes; viz. those obtained from the tree while it is in a living state, and those procured from the wood and roots after the tree is cut down. The first kinds are extracted from the trunk of the tree by making incisions in the bark or wood, from which a resinous matter flows in greater or less quantity, according to the kind of tree; and from this are procured, turpentine, liquid balsam, the common yellow and black rosins of the shops, oil and spirit of turpentine, and some minor articles. The other kinds are procured from the trunk, branches, and roots, after the tree is cut down, by the application of heat; and they include tar, pitch, lampblack, &c. The common turpentine is generally the produce of the pine; and the process for obtaining and manufacturing it will be given under the head *Pinus*. The Strasburg and Venice turpentines are drawn from the silver fir and the larch (see *Picea* and *Làrix*); and the best yellow rosin is that of the spruce fir (see *Abies*). The resinous matter drawn from the trunk of pine trees is put into baskets, and placed over stone or earthenware jars. The fluid part, which runs from it, is the common turpentine; and the solid part left in the basket, when purified by boiling, is the common yellow rosin. Oil, and rectified spirit of turpentine, are distilled from the raw turpentine, and the residuum left after distillation is the black rosin, or colophony, used by players on the violin for their bows. Tar is procured by cutting the wood and roots into small pieces, and burning, or rather charring them, in a close oven, or heap covered by turf, while a tube or trough is left near the bottom of the heap or oven, through which the tar runs, in the form of a thick black fluid. The Swedish tar is the most highly esteemed in commerce; and that of Archangel ranks next to it. In the United States, Michaux informs us, tar is generally made from dead wood collected in the forests, and on this account it is considered very inferior to the tar of Europe. The lampblack is the soot evolved during this process, and is collected from the upper part of the oven, or from the turf which has covered the heap; and pitch is merely tar boiled to dryness. The resinous matter of the spruce, like that of the pine, is collected from incisions made in the bark; but it does not yield its turpentine without the aid of heat and pressure. The resinous juice of the silver fir is obtained by collecting the natural exudations on the surface of its trunk; and that of the larch, from the interior of the trunk, by tapping it with an auger; as is done to obtain the sap of the birch and the sugar maple.

The chemical properties of the resinous juice of the pine and fir tribe have been given at length by Dr. Maton, in Lambert's *Genus Pinus*, from

which the following is abridged:—"The juice of pines and fir trees, like that of the *Pistacia Terebinthus*, has an austere astringent taste; it is viscid and transparent, readily inflammable, and easily becomes concrete. In distillation with water, it yields a highly penetrating essential oil; and the liquor is found to be impregnated with an acid, a brittle resinous matter remaining behind. Digestion with rectified spirit of wine completely dissolves all the resinous part, along with which some portion of the insipid gum, or mucilage, is also taken up. If this solution be filtered, and diluted largely with water, it becomes turbid, and throws off the greatest part of the oil, the gummy substance being retained. If the solution be subjected to distillation, the spirit brings over with it some of the lighter oil, so as to be sensibly impregnated with its terebinthinate odour; and it leaves behind an extract differing from the rosin separated by water, in having an admixture of mucilage. The native juice becomes viscous in water by the mediation of the yolk or the white of an egg, or by that of vegetable mucilage, and forms a milky liquor. Exposed to the immediate action of fire, the roots, and other hard parts of the tree, produce a thick, black, empyreumatic fluid, which, containing a proportion of saline and other matter mixed with the resinous and the oily, proves soluble in aqueous liquids, and, according to its several modifications, constitutes the varieties of tar and pitch. The resinous residue of the several processes to which the matter extracted from pines may be subjected constitutes the varieties of resin, or rosin, colophony, &c. There are also other products, both natural and artificial, much employed in medicine and the arts." (vol. ii. p. 146.)

Medicinal Virtues. "Terebinthine substances, when taken internally, seem to warm the viscera, raise the pulse, and impart additional excitement to the whole vascular system. Applied externally, they increase the tone of the part, counteract the indolence of action, and deterge, as it were, ill-conditioned ulcers." (Ib.) They also act as gentle aperients, and as diuretics; and they possess a styptic property. Formerly, they used to be considered as highly efficacious in pulmonary complaints; and, only a few years since, a gentleman afflicted with asthma is said to have received immediate relief by inhaling the fumes of melted rosin, which he was employing to secure the corks of bottles. The virtues of tar-water were celebrated for curing various diseases, about a century ago; and Dr. Berkeley, Bishop of Cloyne, wrote a long dissertation on the subject, under the title of *Siris; or a Chain of Philosophical Reflections and Enquiries concerning the Virtues of Tar-Water*. Cullen, and other medical writers, appear to have believed in its efficacy, and it was thought to strengthen the tone of the stomach, to excite appetite, and to promote digestion. It was made by pouring a gallon of cold water on a quart of tar, stirring it well together, and then letting it stand for 48 hours, after which the tar-water was strained off for use.

Domestic and Economical Uses of the resinous Products of the Pine and Fir Tribe. The ancients were accustomed to medicate some of their wines with the resinous substances of the pine tree, the astringent flavour of which was also agreeable to their palates. These wines were supposed to assist digestion, restrain ulcerous discharges, and strengthen the bowels; but Dioscorides informs us that they were known to produce vertigo, pain in the head, and many mischiefs not incident to the same quantity of vinous liquor free from such admixtures. In modern times, tar and pitch are extensively used for the purpose of retarding the decomposition of wood, cordage, and other articles, more especially in marine affairs. Tar alone, or mixed with grease, or, as in some parts of the Continent, with clay, is much used for greasing wheels and machinery. Tar is also applied to wounds in horses and cattle, and as a remedy for sheep having the scab. Yellow rosin is employed in the manufacture of common yellow soap, in the proportion of 3 cwt. of rosin to 10 cwt. of tallow, both in Europe and America. Shoemaker's wax is a composition of pitch, oil, and suet; but it is also made of rosin, bees' wax, and tallow, as is the grafting wax used in gardening, sometimes with the addition

of a leafy and resinous bark. Turpentine, in all its different forms, is extensively used, along with oil, in painting. Tar and pitch, with a mixture of tow, or beaten cables, are used for paying over the seams of the sides and decks of ships after they are caulked, to preserve the oakum from any wet. Oakum is formed of untwisted old ropes, steeped in tar, and is in universal use in ship-building. Lampblack is used by painters, both with water and oil; and also by modellers, and other artists and artisans.

As ornamental objects, most of the species of the *Abiétinæ* are eminently deserving of culture, and they may all be said to be beautiful in every stage of their growth, from the regularity and symmetry of their forms, from their foliage being evergreen, and from the lofty stature attained by most of the species when full grown. The resinous odour of most of the species is also a powerful recommendation to many persons in modern times, as it was anciently to the Greeks and Romans. The fragrance of the common spruce fir is considered, in Sweden and Norway, to be particularly agreeable and refreshing; and, hence, the floors of cottages are generally strewed with it in those countries. In the *Descriptive* of Johnston, groves of pine are said to be particularly wholesome to walk in; and every one must have felt the refreshing influence of such a walk in the beginning of summer, when the pines are producing their young shoots, and the weather is warm; the resin at that time being in a comparatively volatilised state, and floating in the atmosphere. Among the most ornamental species are, the cedar of Lebanon, the cedar of Deodar, the silver fir, the *Arceuthobium imbricatum*, and the *Picea Webbiana*; but all the species are ornamental in an eminent degree, when full grown, as single objects. No species is more picturesque than even the common Scotch pine, when it has stood detached, has attained a considerable age, and has grown in a suitable soil and situation. Some of the commonest species, in particular localities, and from accidental circumstances, become very singular objects; such as the spruce fir when its branches take root at their extremities, and send up shoots which become trees; or when, from being thrown down on its side, its branches become trees, proceeding from the parent trunk. The same species also affords a curious monstrosity (*Abies excelsa Chamberlainiana*), which, when propagated, becomes a bush, seldom seen above 3 ft. or 4 ft. high. The silver fir and the cedar of Lebanon, and also the larch, often form branchy heads, which, from such heads rarely occurring in needle-leaved trees, have a very singular appearance.

Soil and Situation. The debris of granitic rock may be considered as the universal soil of the pine and fir tribe, and a dry subsoil an essential condition for their prosperity; but they will grow on all soils whatever, that are not surcharged with water. The roots of all the *Abiétinæ* run immediately under the surface, and hence do not require a deep soil; and, as their needle-like leaves do not carry off much moisture by evaporation, the soil in which the *Abiétinæ* will grow to a large size may be drier than that required for any other kind of tree. In pine and fir forests, or extensive groves, the leaves and decaying fronds of the trees drop on the surface of the ground, and not only retain moisture in the soil, by forming, from the much longer time which they require to decay, a non-conducting stratum of greater thickness than is ever found in groves of broad-leaved trees, but they supply a layer of vegetable food to the roots. When the trees stand singly, or in scattered groups, their fronds or branches, being fully exposed to the light and air, do not decay so readily as they do when grown in thick masses, from which the air is, in a great measure excluded; and, consequently, so much moisture is not supplied by them: but, on the other hand, as in this case they cover the ground so as to exclude in a great measure the sun and air, evaporation is prevented, while, from the greater range which the roots have on every side, abundance of nourishment is supplied. Nevertheless, a soil somewhat loamy, and a cool subsoil, are necessary to bring the timber of the pine to its greatest degree of perfection; and various species, particularly those belonging to the genus *Picea*, require a loam rather rich than poor, and a situation low rather than

elevated. *P. sylvéstris*, and some other species, will grow in bleak exposed situations on lofty mountains; and *P. Pinaster*, and others belonging to that section of *Pinus*, will endure the sea breeze: but, in general, wherever the *Abiétinæ* are to be exposed, they require to be planted together in masses, so as to shelter one another. None of the species, however, become ornamental when so planted; because they necessarily lose their side branches, on the preservation of which, either wholly or partially, from the ground to the summit of the trees, their characteristic beauty almost entirely depends.

Propagation. The only mode of propagating the pine and fir tribe on a large scale is by seeds; but all the species will succeed by layers, by inarching on closely allied kinds, and by herbaceous grafting; and many, if not all, may also be propagated by cuttings. That the *Abiétinæ* might be propagated by layers and cuttings was known in the time of Evelyn, and was "divulged" by him, "as a considerable secret." Cook, also, mentions these modes of propagating pines and firs in his *Forest Trees*, third edition, p. 117.; but they have never till lately been much in use. At present, in the Horticultural Society's Garden, and in the Fulham and other nurseries, upwards of twenty different species of the *Abiétinæ* are propagated by cuttings with the most perfect success; the plants, in most cases, becoming as handsome trees as if they had been raised from seed. The only exceptions to this result are, where the plant becomes bushy, and does not throw up a very decided leading shoot; but this can always be obtained by pegging the branches down to the ground, and leaving the collar fully exposed; whence one or more vigorous shoots will not fail to be produced, from which a leader may be selected, and all the others kept pegged down for a year or two longer, and afterwards cut away by degrees. We have no doubt that, by this manner of treatment, a plant of the little stunted monstrosity of the spruce fir, called *Abies Clanbrasiliana*, might be restored to the natural form and magnitude of the species.

By Cuttings. The species which strike by cuttings most readily are those belonging to the genera *Picea*, *Abies*, *Larix*, and *Cedrus*. The cuttings may be taken from the lateral branches, when the current year's shoots are beginning to ripen, and prepared like those of Cape heaths; they should then be planted in sand, and covered with a glass. This being generally done in August or September, the cuttings should be kept in a frame, from which frost is excluded, throughout the winter; and the greater part of them will send up shoots the following May or June, and may be transplanted the succeeding autumn. In the London Horticultural Society's Garden, where Mr. Gordon, the superintendent of the arboretum, is singularly successful in this mode of propagating the pine and fir tribe, the cuttings are generally taken off from the points of the lateral shoots in September; and, being planted in shallow pots of sand, they are placed in the shady part of a frame, without being covered by bell-glasses, till the following spring; when they are put into a very gentle moist heat, and begin growing in April. The kinds which Mr. Gordon has found to strike most easily are, *Abies Smithiana*, *A. Douglasii*, *A. Menziesii*, *Picea Webbiana*, and *Cedrus Deodora*. After many trials, and a good deal of experience on the subject, Mr. T. M. Lindsay, gardener to the Earl of Caernarvon, at Highclere, says: "I have found the autumn the best time to put in the cuttings; and, though the early spring will answer the purpose, I have not found success so certain at that season. The sort of cuttings I prefer are the smallest I can select, from 2 in. to 3 in. long; they should be of the current year's growth, and taken off just as the wood is ripened, say about the beginning or end of October. The cuttings should be cut off close at the commencement of the season's growth; or, if stripped off, and then cut, so much the better. I have found silver, or pure white, sand, with a small portion of peat bog or heath mould mixed with it, answer the purpose better than sand alone. With respect to bottom heat, I have been successful both with and without it; and think that a little of it,

at a certain season, is of service, although by no means when the cuttings are first put in. I would recommend the cuttings, for the first five or six weeks, to be covered with a bell-glass, and placed in a shady part of any house or pit where the thermometer generally stands at about 60°; after which they may have a little bottom heat, which may be increased until they are rooted. It is doubted by many, whether plants of Coniferæ, raised from cuttings, will ever form leaders, like seedling plants, unless a leader be selected for the cutting. I can only say that all I have raised have formed good leaders, and many of them have grown 6 in. this season (1837). The following are the species which I have raised from cuttings:—*Pinus sylvestris*, *halepensis*, *Cembra*, *excelsa*, and *monticola*; *Abies excelsa*, *nigra*, *Pichta*, *Sibiriana* (*Morinda*), *Menziesii*, *Douglasii*, and *Cianbrasiliæna*; *Picea pectinata*, *nobilis*, *Webbiana*, and *amabilis*; *Larix microcarpa*; *Cedrus Libani* and *Deodara*; *Cunninghamia sinensis*; *Araucaria imbricata*."

By Grafting. The application of this mode of propagation to the pine and fir tribe was first made by the Baron Tschoudy, probably about the end of the last century; and was practised by him on his estate at Colombey, near Metz, and in the Botanic Garden of that city. It is described at length in various works, of which one of the latest is the *Traité Pratique* of Delamarre, p. 138. 142.; the essence of which is as follows:—The species intended to be united should be as nearly allied as possible; for, though the pinaster, and the *P. Pinea* may be grafted on the *P. sylvestris*, and the cedar on the larch, yet it is preferable (because the grafts succeed better, and the trees produced are likely to last longer) to graft species which are evergreens on evergreen stocks, and those with the leaves in bundles on stocks not only with the leaves also in bundles, but with the same number of leaves in each bundle. *P. Pinea* is found to succeed remarkably well on *P. maritima*, and *P. Cembra* on *P. Strobus*. The operation of herbaceous grafting is performed in the cleft manner; the slit being made a little deeper than that part of the scion which is to be inserted in it. The time of performing the operation is when the leading shoot of the stock has attained the length of from 8 in. to 12 in., and will break over (without tearing the bark) like a piece of glass, or the most succulent part of a shoot of asparagus fit to gather for the table. The time during which any given species has its leading shoot in a fit state for being broken over in this manner is not more than 15 days; and, as the scions from the species to be grafted are equally tender with the stock, they will not remain longer in a state fit for the operation than about the same period. The graft is always inserted in the leading shoot; the greater number of the side shoots are either removed altogether, or shortened; and the young shoots produced from the stocks during the season are pinched off with the finger and thumb at about half their length. In performing the operation, the first step is to break over the leading shoot with the hand, so as to reduce it to the length of from 4 in. to 6 in.; the leaves are next removed from this remaining portion, with the exception of about an inch at the top, on which they are left for the purpose of drawing up the sap. The scions should have been procured the same day or the evening before, from the extremity of the branches of the kinds to be grafted; and they should be preserved in a vessel of water, and covered with grass or leaves to exclude the sun. The scions need not be above 3 in. in length; the lower half of which should be deprived of its leaves, and cut in the form of a thin wedge, the operator using a very sharp knife. The scion should be rather narrower than the stock, in order that it may be more completely tied into it, which is done by a ligature of matting, or woollen twist. After this is done, the graft is covered with a cornet of paper, slightly tied to the stock, so as to exclude the sun, but yet admit the air. From 10 to 15 days after grafting, the cornet may be taken away; about 15 days later the ligature may be removed; and in six weeks or two months afterwards, the upper part of the stock left with the leaves on may be trimmed off on both sides of the scion, and all the shoots which have been produced on the lower part of the stock removed, so as to throw the

whole of the sap into the scion. A good workman, it is said, will graft 200 or 250 subjects a day, provided he have an assistant to cut the side shoots from the stock, and prepare the scion; leaving him nothing to do but to break off the leading shoot of the stock, make the slit in it, insert the scion, tie the ligature round it, and fix on the paper envelope. The shoot made by the scion is little or nothing for the first year; but the second year it is considerable, and the third a foot or more, and most frequently from 2 ft. to 3 ft. in length. The future shoots, says Delamarre, are truly admirable for their length, their thickness, and their great vigour. The most suitable stocks are plants sown where they are finally to stand; and of 4, 5, or 6 years' growth, the object being to make the graft 3 ft. or 4 ft. from the ground, to avoid the necessity of stooping on the part of the operator. Grafting in this manner has been carried to a great extent by M. De Larminat, in the Forest of Fontainebleau. In the *Bon Jardinier* for 1826, it is stated that about 10,000 scions of *P. Laricio* had been at that time grafted on *P. sylvestris* in that forest; and M. Delamarre informs us, in 1830, that the process had been continued up to that time, at the rate of several thousand trees every year.

The mode of grafting practised by M. De Larminat is described by M. Poiteau in the volume of the *Bon Jardinier* above referred to; and we give it here, because it differs, though in a very slight degree, from that just described. The proper time for grafting pines is when the young shoots have made about three quarters of their length, and are still so herbaceous as to break like a shoot of asparagus. The shoot of the stock is then broken off about 2 in.

under its terminating bud; the leaves are stripped off from 20 to 24 lines down from the extremity; leaving, however, two pairs of leaves opposite and close to the section of fracture, which leaves are of great importance. The shoot is then split with a very thin knife, between the two pairs of leaves (fig. 2009 *a*), and to the depth of 2 in.; the scion is then prepared (*b*); the lower part, being stripped of its leaves to the length of 2 in., is cut, and inserted in the usual

manner of cleft-grafting. They may be grafted, also, in the lateral manner (*c*). The graft is tied with a slip of woollen; and a cap of paper (fig. 2010.) is put over the whole, to protect it from the sun and rain. At the end of 15 days, this cap is removed, and the ligature at the end of a month; at that time, also, the two pairs of leaves (*a*), which have served as nurses, are removed. The scions of those

sorts of pines which make two growths in a season, or, as the technical phrase is, have a second sap, produce a shoot of 5 in. or 6 in. the first year; but those of only one sap, as the Corsican pine, Weymouth pine, &c., merely ripen the wood grown before grafting, and form a strong terminating bud, which in the following year produces a shoot of 15 in. or 2 ft. in length. (*Gard. Mag.*, vol. ii. p. 200.) This mode of grafting was practised by the Baron Tschoudy, who gave it the name of herbaceous grafting, not only with the pine and fir tribe, but with every other class of ligneous plants, and also with herbaceous vegetables. It is very generally practised by the Paris nurserymen, and especially by M. Soulange-Bodin, though it is, as yet, but little known in British gardens. One of the first trees, that we are aware of, that was grafted in this way in Britain, was an *Abies Smithiana*, at Hopetoun House, which was grafted on a common spruce in 1826, the same year in which the above account appeared in the *Gardener's Magazine*. This tree is now (1837) 10 ft. high.

By Seed. The number of seeds in a cone varies according to the



species, some containing as many as 300; and the seeds of most species, when allowed to remain in the cone, preserve their vegetative power for several years. The cones are mature, in some species, at the end of the first year, but, in most, not till the end of the second autumn. They ought to be gathered a short time before they are perfectly ripe, in order to prevent the scales from opening, and the seeds from dropping out. In the European *Abiétinæ*, the seeds begin to drop from the cones which remain on the trees generally in March; for which reason February is a good month to collect them. The cones of *Pinus sylvestris*, and of the allied sorts, soon open of themselves, after they have been gathered from the tree, and spread out in the sun; but the cones of *P. Pinaster*, *P. Pineæ*, and the allied sorts, though treated in the same manner, will not open their scales for several months, or even a year. The cones of *Cèdrus Libani* will not open till they have been three years or upwards on the trees; and, when they are gathered, it is almost always necessary to steep them in water for 24 hours, and afterwards to expose them before a fire, or to the sun. In Scotland, France, and Germany, the seeds of the *Pinus sylvestris* and of the *Larix europæa*, are very commonly separated from the cones by kilndrying, and afterwards thrashing them; but, as the heat of the kiln is sometimes carried to such excess as to destroy the vital principle, it is considered safer to steep the cones before drying, in which case less fire is requisite; or to split them by inserting an iron triangular-pointed instrument, not unlike a shoemaker's awl, into the axis of the cone, at its broad end. The cones are also sometimes broken by passing them through a bone-mill, or between two cylinders; or by putting them into a bark-mill. The cones of the silver and the balm of Gilead firs, and also of the *Pinus Stròbus*, open of themselves in a dry room, and give out their seeds with less trouble than those of any other species.

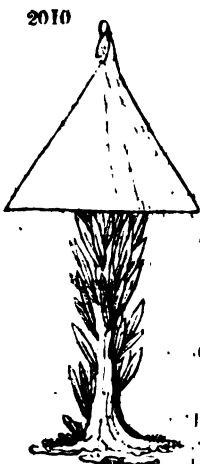

A Kiln for drying the Cones of the *Abiétinæ* is described by Sang, as being constructed in the manner of a common malt-kiln. The joists or beams which support the floor, or surface on which the cones are to be spread, should be about 9 ft. above the hearth on which the fire is placed, and 2 in. apart. "A haircloth is spread over them from side to side of the kiln, and the cones are laid on it to the thickness of 12 in. or 14 in. A gentle fire is then applied, and regularly kept up till the cones become opened. During the time of drying the cones must be frequently turned upon the kiln; and when the seeds begin to drop out, they must be removed to a dry shed, and sifted till all the seeds which are loose fall out, and be taken from among the cones. The cones are afterwards to be thrashed severely with flails, and sifted as before, and so on till the seeds are taken out as completely as possible." (*Kalendar*, p. 326.) Various modes of constructing drying-kilns will be found given in our *Encyclopædia of Cottage, Farm, and Villa Architecture*.

The most general Time for sowing the Seeds of the *Abiétinæ* is in the end of March, or in April. The ground ought to be in good heart, light, and sandy rather than loamy, and prepared as finely as possible. The seeds may be most conveniently sown in beds; and, after being gently beaten down with the back of a spade or a slight roller, they should be covered with light soil or leaf mould to the depth of a sixteenth, an eighth, or, at most, a quarter, of an inch, according to the size of the seeds, and covered with branches of trees or shrubs, fronds of fern, wickerwork hurdles, or netting, to shade the soil from the sun, and protect the seeds from birds. If, indeed, the seeds are gently patted in with the back of the spade, and the beds kept shaded, and of a uniform gentle moisture, no covering at all is

necessary. When rare kinds are sown in pots, if the surface of the soil is kept 1 in. below the rim of the pot, the pot may be covered with a pane of glass, and the seeds will come up with certainty and vigour. Traps ought to be set for mice, which are great devourers of the seeds of the *Abiétinæ*. In very dry weather the beds should be watered in the evenings; but in this case it becomes doubly necessary to shade them in the day time; because in proportion to the rapidity of the germination of the seeds are they liable to be scorched by the sun. The precaution of shading is much less necessary in Scotland, than in England, or on the Continent; and, though it requires to be regularly practised in the Goldworth Nursery, in Surrey, yet we believe it is altogether neglected in the nurseries in the neighbourhood of Aberdeen, where more plants of the Scotch pine and larch are, we believe, raised, than in any other nurseries in the world. The seeds of the greater part of the *Abiétinæ* come up in from 30 to 50 days. Those of *P. Pinea* have been known to come up in 28 days; though some of this species often do not come up till the second year, and seeds of *P. Pinaster* often not till the third year. Great care must be taken, when the seeds are coming through the ground, to raise sufficiently above them the material employed in shading the beds, and also to remove it by degrees. The young plants, in most of the species, grow slowly the first two or three years; but some few, such as the Scotch pine and the larch, grow with comparative rapidity; and all of them grow most rapidly between their fifth and their tenth years.

Culture. The pine and fir tribe do not, in general, succeed so well when transplanted as the broad-leaved trees; for which reason, most of the sorts planted for ornament, such as the cedar, stone pine, Weymouth pine, Siberian pine, &c., should always be kept by the nurserymen in pots. The Scotch pine, the larch, the spruce, the silver and balm of Gilead firs, the Corsican pine, and the Weymouth pine, may be transplanted into nursery lines, from the seed-bed, in the second year; and, after remaining one year in these lines, they may be removed to where they are finally to remain. Very few species can be kept with advantage for a longer period in the nursery than 3 years; viz. two in the seed-bed, and one transplanted. The species which may be kept longest, and afterwards transplanted with safety, is the common spruce, on account of the concentration of its roots, and its very numerous fibres. The worst species for transplanting is the pinaster; because it has more of a taproot than any other of the *Abiétinæ*. In transplanting all the species to where they are finally to remain, attention should be paid not to plant them too deep; and to have a pit sufficiently large to admit of spreading out the roots in every direction. This spreading out of the roots is more especially necessary in the case of plants that have been kept for years in pots, and that have not naturally taproots; for, when it is neglected, the plants are often many years before they become firmly established and grow vigorously. The reason of this is easily explained. The roots of a tree, when confined in a pot, may be compared to the head of a tree which has been for several years confined and clipped into some regular shape, so as to present an exterior surface of spray and leaves, without any one shoot being stronger than another. Hence, when the head of such a tree is left to itself, a smaller or greater number of years will elapse before a leading shoot, or one or two leading shoots, are produced; and till that is the case, and the sap, in consequence, is diverted into main channels, instead of being equally distributed over the surface of the bush, no vigorous growth can take place. In like manner, the matted roots of a plant which has been a long time kept in a pot, when they are not spread out in transplanting, will be some years before they throw out leading or main roots, without which the part of the tree under ground can no more grow vigorously, than the part above ground can grow vigorously without main branches. The proper time for transplanting the *Abiétinæ* is, as in the case of all other trees, when the sap is in a comparatively dormant state, which is between the end of autumn and the beginning of spring; but, when the plants are of any size, care must be taken to perform the operation

only in mild weather, when there are no drying winds, and, if possible, during gentle rains. In the case of all the more tender species, the plants ought to be surrounded by matting fixed to stakes, at a short distance from the extremities of the branches; or, what is best of all, and serves at once as a shelter from the sun, a protection from the wind, and a guard against cattle, a cylinder of wickerwork ought to be placed round each plant. No pruning ought to be given to the heads, and nothing should be cut from the roots, but such of their extremities as are bruised. When the common *Abie'tinæ*, such as the Scotch pine, the spruce, the larch, and the silver fir, are taken up out of the nursery lines for transplanting, their roots should be immediately plunged into a mixture of loam and water, so as to cover them with a coating of mud; and in that state they ought to be carried to the place of planting, and carefully inserted in the soil with as little delay as possible. For want of this precaution, a great proportion of evergreen *Abie'tinæ*, of three or four years' growth, perish when they are taken up, and carried to any distance; more especially if the weather, at the time of planting, should happen to be dry. The *Abie'tinæ* are, of all trees, the least adapted for being sent to a distance, unless in pots. After the *Abie'tinæ* have been transplanted, and become established in the soil, they require very little care for a number of years, and, perhaps, less than trees of any other order. No care is requisite, unless in particular cases, either to provide a leading shoot, or to prevent any of the branches from coming in competition with the main trunk; cares which are always more or less attendant upon the culture and management of every kind of broad-leaved tree.

When plantations of *Abie'tinæ* are to be made on a large scale, the best mode, in some cases, is, to sow the seeds where the plants are finally to remain, either in drills, which appears the most scientific mode, as it will admit of regular culture between the rows, or broadcast; and, where the surface is steep and rocky, by sowing in irregular patches. There are many objections to sowing, however, which generally render planting the most profitable mode. A great quantity of seed is required, to provide for the ravages made by birds and other vermin; and the labour of preparing the soil, if this is done properly, is greater in proportion to the number of plants wanted, than in the case of planting. There is also a certain loss of time; since plants three years old, which have been one year transplanted, will be at least three years in advance of seedlings raised where they are to remain. On rocky steeps, however, where there is little or no visible soil, and where the seed can only be deposited in chinks and crevices, or sown on occasional patches of soil, this mode of raising a wood of pines and firs may deservedly have the preference.

Very little *pruning* is necessary for the pine and fir tribe, whether they are grown singly or in scattered groups for ornament, or in masses for useful purposes in plantations. In the former case, to remove any of the branches would destroy the object in view; and in the latter, if the plantation is of suitable thickness, the lower branches begin to die off of themselves, after the trees have acquired a certain age and growth, and all that is necessary is to assist nature, by cutting off the branches close to the trunk, the moment they begin to show indications of decay. Some authors contend that no pruning whatever ought to be given to the pine and fir tribe; and that they ought to be planted so close together, that the branches may rot off when they are quite small, as the trees advance in height. This is, doubtless, the manner in which the clean timber of the pine and fir forests of the north of Europe is produced; but it must be recollected that this timber is obtained at a great expense of time; for, if the trunk is deprived of so many of its side branches, while it is small in diameter, the tree must require to stand many years before the few branches composing its head can elaborate a sufficient portion of sap to thicken the stem to a timber-like size. Some, on the other hand, recommend depriving the trees of branches to two thirds of their height, which must place them nearly in the situation of trees drawn up in their natural forests. To us, there appears no reason for making the *Abie'tinæ* an

exception to other orders of trees with respect to culture. They may require a culture of a different kind, but, if they are to be subjected to any, they must be pruned, and otherwise treated, so as to fit them for his purposes in the most complete manner, and in the shortest possible time; unless it can be shown that, in an artificial state, they will become fit for these purposes in a sufficiently short time, without pruning, or any other kind of culture. M. Loiseleur Deslongchamps and M. Bosc affirm that the *Abiétinæ* have more need of numerous branches than the broad-leaved trees; because, say they, the pines absorb from the atmosphere as much nourishment by their leaves, as they draw from the soil by their roots. These authors recommend pines and firs to be left wholly without pruning for the first eight or ten years; that at that time the lowest tier of branches may be cut off; and that afterwards a tier may be cut off annually, till the trunk is cleared to the height of 6 ft. or 7 ft.; after which they should be left entirely to nature. We cannot, however, counsel leaving them entirely to nature, even after this period; because, in that case, when the branches began to decay and drop off, the stumps which remain would become buried in the wood, and would greatly diminish its value. M. Hartig is in favour of pruning the *Abiétinæ*; but M. Burgsdorf is of a contrary opinion. According to M. Delamarre, the majority of French authors recommend pruning and thinning; and the practice in the department of the Maine, where his estate lay, is to cut off the branches at 2 in. or 3 in. from the trunk, in order to leave some small shoots and leaves to draw up the sap. In Champagne, he says, 6 in. are left at first; and, in a year or two afterwards, these are cut off close to the trunk. Delamarre adds that 2 in. is the preferable distance; and a stump of this length, he says, will, in three or four years, be buried in the trunk of the tree. In Britain, and also in most parts of Germany, close pruning has the decided preference. The advantage of early and close pruning, in the case of the pine and fir tribe, was pointed out by Mr. Salmon, in the *Transactions of the Society of Arts*, about the beginning of the present century; and afterwards strongly recommended by Mr. Pontey, in his *Forest Pruner*, and practised by him in various places where he had the management of the plantations. It is generally considered, however, that Mr. Salmon and Mr. Pontey carried the practice of close pruning too far. Mr. Main, who has paid great attention to the subject of pruning, states it as his opinion, that all the pine and fir tribe intended for profit should be planted to grow up, and be "all cut down together, like a crop of corn." Mr. Salmon, on the other hand, gives the following directions, founded, as he says, on several years' observation and experience:—"The pruning should commence when the trees are six years old, or, in other words, when five distinct tiers of branches appear on the stem. The lowest of these tiers are to be taken off, leaving four remaining. After which, at every succeeding four or five years, the pruning is to be repeated, till the stem of the tree be cleared to the height of 40 ft.; after which the tree may be left to nature. The best practice seems to lie between Mr. Main's opinion and that of Mr. Salmon; and we should think that if small poles and masts were the object, Mr. Main's plan would be the best; but for large beams, planks, and deals, Mr. Salmon's. We shall hereafter have occasion to enlarge on the subject, when treating on the pruning of particular species, and more especially of *Pinus sylvestris*. In exposed situations, Mr. Nuttall has found that the *Abiétinæ* are much invigorated at the root by pinching out the points of the side shoots, and even of the leading shoot; which causes the plants to increase in diameter at the base, and to become furnished with roots, larger and more vigorous, in proportion to the elevation of the stem, than would otherwise be the case, which consequently enables them the better to withstand the force of high winds. Plants so treated soon recover their leading shoots; or, if they send up more than one, the superfluous ones can be removed. The details of Mr. Nuttall's practice will be found in the *Gardener's Magazine*, vol. xiii. p. 350. The best season for pruning the *Abiétinæ* is in mild weather in early spring, or in the autumn."

Thinning and Felling. Thinning ought to be carried on in connexion with pruning; and, when large timber is to be produced, this is no less necessary in the case of the *Abiétinæ* than in that of the broad-leaved trees; though the former, from their narrow conical shapes and great height, do not require so much room as the latter. The advantages derived from thinning will be shown in a striking manner from actual practice in Britain, when we come to treat of the larch.

The pine and fir tribe, not being trees that stole, are never cultivated as coppice-wood; and when a grove of pines is felled, the roots ought to be taken up, in order to clear the way for the succeeding crop. In the German and French works on the culture of the *Abiétinæ*, there is much difference of opinion as to whether a grove of pines or firs, when full grown, and fit for timber, ought to be wholly cut down at once, "like a crop of corn" (to use Mr. Meun's phrase), or cut down by degrees by thinning out. If the latter mode is considered the best, another point arises for discussion; which is, whether the smaller trees are to be taken out, so as to leave room for the large ones to grow larger, which is called *exploitation par éclaircies*; or the larger ones removed to leave room for the small ones to increase in size, which is called *exploitation en jardinant*. In the *Dictionnaire des Eaux et Forêts*, a comparative view is given of these two modes, and the preference is given to the first; but both, it is alleged, are inferior to the mode of cutting down the entire grove or forest at once; and this seems the most rational, because, when the air is once let in to a grove of full-grown pines, they seldom increase much in size afterwards; doubtless, from the influence of the weather on their naked trunks, which have, till then, been shaded and protected by the evergreen branches of the trees that have been removed. Deciduous trees, as they never receive so much protection from one another, never suffer so much from thinning, whether when young, or when mature and fit for felling as timber. The season for felling the *Abiétinæ* is during winter; but in the Alps and the Pyrenees, and also in the north of Sweden and Norway, where the ground is covered with snow for six or seven months in the year, the trees are cut during summer. It is alleged that the wood felled during the latter season, from the greater quantity of sap contained in it, must necessarily be less durable than that felled when the sap is dormant. This, however, must chiefly apply to the sap wood; because the heart wood, which alone is used for important purposes, is not penetrated by the ascending or descending sap. After the trees are felled, the roots are dug up, broken into small pieces, and distilled for tar; or burned in covered heaps for that product jointly with charcoal.

In situations naturally adapted for the progress of pines and firs, the self-sown seeds keep up a perpetual succession of the same species for an unknown period: but when the plantation is cut down before the trees have shed abundance of seeds; or where, from being an artificial plantation of trees all planted at the same time, the ground is so completely shaded, as to prevent the vegetation of the seeds which may have dropped on it; or where the soil is not naturally congenial to the *Abiétinæ*; in any of these cases, this order ought to be succeeded by another totally different from it, but at the same time suitable for the soil. Many authors have observed that native woods, both in England and America, when cut down, are generally succeeded by a different kind of tree (see *Gard. Mag.*, v. p. 421.); and others, that pine forests, when destroyed accidentally by fire, in America, are usually succeeded by oak. M. Le Comte of Riceborough, Georgia, has for upwards of thirty years paid great attention to the subject of the natural succession of woods; and the following are the results of his observations respecting pine forests:—"The pine lands in the southern states have generally old oak grubs, which, by reason of the periodical fires, are prevented from becoming trees, notwithstanding which they still continue alive (see p. 1891.); and when land is turned out (that is, when the cultivation of it is relinquished), the pines, being naturally unproductive of

smokers, are consequently killed *in toto*; while the oak, now sole possessor of the soil, starts up and grows vigorously. On the other hand, land which has been solely occupied by oaks previously to its cultivation, is invariably of a superior quality to what is termed pine land; and is naturally a longer period under cultivation before it is turned out, by which means the roots of the oaks are completely eradicated. The pine seeds, being winged, and thereby easily carried by the wind to a considerable distance, if the ground is free from the roots of other trees, are the first to establish themselves; and, being of a free and rapid growth, they take the lead of all other species of timber, and become the principal occupiers of the land: but when the roots of the oaks are not destroyed, they will take the lead, and resist the pine and other trees. All pine lands, which originally had no oaks, will invariably produce pines again, whether they have been under cultivation for a long time or a short period." (*Gard. Mag.*, vol. viii. p. 287.) In the north of Europe, including the Highlands of Scotland, a pine forest, unless it has been cleared, and the soil brought under the plough, or laid down in pasture, continues such for ever; the seeds of the older trees coming up in the open spaces, as thick as in the nurserymen's seed-beds.

Accidents. With reference to the goodness and value of the timber, the most injurious accident that can befall a pine or fir tree is to have the dead stumps of the side branches left on, whether through neglect in artificial plantations, or from the trees not being sufficiently close together in natural ones. In such cases, the dead stump is buried under the living wood; and, when the tree is sawn up into boards, every point where these stumps intersect the board forms a knot, which, if not glued in, generally drops out, leaving a hole through the board. The pine and fir tribe, from their resinous nature (resin being a powerful non-conductor), are said to be less liable to be struck by lightning than broad-leaved trees; and hence they are considered as particularly suitable for growing on mountains. (See Nuttall in *Gardener's Magazine*, vol. xiii. p. 351.) As, when standing singly, their spiry tops do not oppose so large a surface to the wind as those of round-headed trees, and as their narrow leaves offer very little resistance, they are not so liable to be blown down by high winds as might be imagined from their comparatively small roots; and they are still less so when associated together in dense masses of plantation or forest. As forests of the pine and fir tribe are generally situated on hills or mountains, and for the most part in climates where they are subject to be covered with snow for several months in the year, they are very liable to what may be called geological and meteorological accidents. In Switzerland, those movements of rocks, stones, and soil which take place in the mountainous districts, more or less every spring, and are called *éboulemens*, often destroy several acres of pine forests at a time. In scattered forests, the snow falling on the trees individually is retained by their branches, and, when these are of great length, often weighs them down, and breaks them; while those movements of snow known by the name of *avalanches* are sometimes as injurious as the *éboulemens*. We have seldom been more gratified with winter scenery, than when passing through a spruce fir forest in Sweden. We have seen trees of all ages grouped and distributed in innumerable ways; here weighed down with snow, and there boldly shooting through it their vivid green pyramidal heads. When a sudden thaw takes place in spring, the snow and the branches seem all in motion; some branches, being relieved from their load of snow, are rising up in consequence of their elasticity; and others, from the snow falling on them from branches still higher up the tree, are bending, and perhaps breaking, under the additional weight. In the pine and fir forests of Europe, a number of branches, and also of entire trees, are damaged in this way every year; but this is nothing to the havoc which takes place in America, during what is called an "ice storm." In the *Magazine of Natural History* (vol. vi. p. 100.), a very striking description of one of these storms at Philipsburg, near the Alleghany Mountains, is given by R. C.

Taylor, Esq. A heavy fall of snow had been succeeded by a partial thaw and rain, followed by a severe frost, which enveloped "the trees and earth in a thick coating of transparent ice." The following morning, the accumulation of ice on the branches of the forest trees presented a beautiful and extraordinary spectacle. The noblest timbers were every where to be seen bending beneath the enormous load of ice with which their branches were incruited, and the heavy icicles which thickly depended from every point; the thickness of the ice, even on the spray, often exceeding an inch. The smaller trees, from 20 ft. to even 50 ft. in height, were bent to the ground by this unwonted burden, and lay pressing on one another, resembling fields of gigantic corn, beaten down by a tempest. Above, the taller trees drooped and swung heavily; their branches glittering, as if formed of solid crystal; and, with the slightest breath of wind, clashing against each other, and sending down showers of ice. The following day, the limbs of the trees began to give way beneath their load. The leafy spray of the hemlock spruce was thickly incased, and hung drooping round the trunks upon the long pliant branches, until the trees appeared like solid masses or monumental pillars of ice. Every where around was heard the crashing of the branches of the loftiest trees of the forest, which fell to the earth with a noise like the breaking of glass, yet so loud as to make the woods resound. As the day advanced, instead of branches, whole trees began to fall; and, during twenty-four hours, the scene which took place was as sublime as can well be conceived. There was no wind perceptible, yet, notwithstanding the calmness of the day, the whole forest seemed in motion, falling, wasting, or crumbling, as it were, piecemeal. Crash succeeded to crash, until at length these became so rapidly continuous as to resemble the incessant discharges of artillery; gradually increasing, as from the irregular firing at intervals of the outposts, to the uninterrupted roar of a heavy cannonade. Pines of 150 ft. and 190 ft. in height came thundering to the ground, carrying others before them. Under every tree was a rapidly accumulating debris of displaced limbs and branches; their weight increased more than tenfold by the ice, and crushing every thing in their fall with sudden and terrific violence. Altogether, this spectacle was one of indescribable grandeur. The roar, the cracking and rending, the thundering fall of the uprooted trees, the startling unusual sounds and sights produced by the descent of such masses of solid ice, and the suddenness of the crash when a neighbouring tree gave way, was awful in the extreme. Yet all this was going on in a dead calm, except, at intervals, a gentle air from the south-east slightly waved the topmost pines. Had the wind freshened, the destruction would have been still more appalling.

Another kind of accident to which pine forests appear particularly liable is their destruction by fire; and, in Siberia and in North America, immense tracts of pine forest are sometimes thus consumed. The fire generally originates with man, either purposely or by accident; but it is supposed sometimes also to be produced by the action of the sun upon the dry decayed wood of fallen trees; and sometimes, no doubt, it is the effect of lightning. In Captain Hall's *Sketches in Canada, &c.*, he gives the following description of an American pine forest on fire:—"Sometimes the monotony of the pine barren was interrupted, in no very pleasant style, by the heat and smoke arising from the forest being on fire on both sides of us; though, as it happened, we were never exposed to any danger, or to serious inconvenience, in consequence of these conflagrations. The sketch (*fig. 2011.*) shows the forest in the predicament we have alluded to. The tree in the foreground had caught fire near the ground; and having, I do not know how, been hollowed out in its centre, the flames had crept up and burst out some feet higher, so that they were roaring like a blast furnace, and rapidly demolishing the tree at the bottom, while the branches at top were waving about in full verdure, as if nothing unusual was going on below." (*Hall's Sketches in Canada, &c.*, No. 24.) Mr Gregor informs us that in New Brunswick the forests are sometimes purposely set on fire by the settlers, to avoid the labour of cutting down the

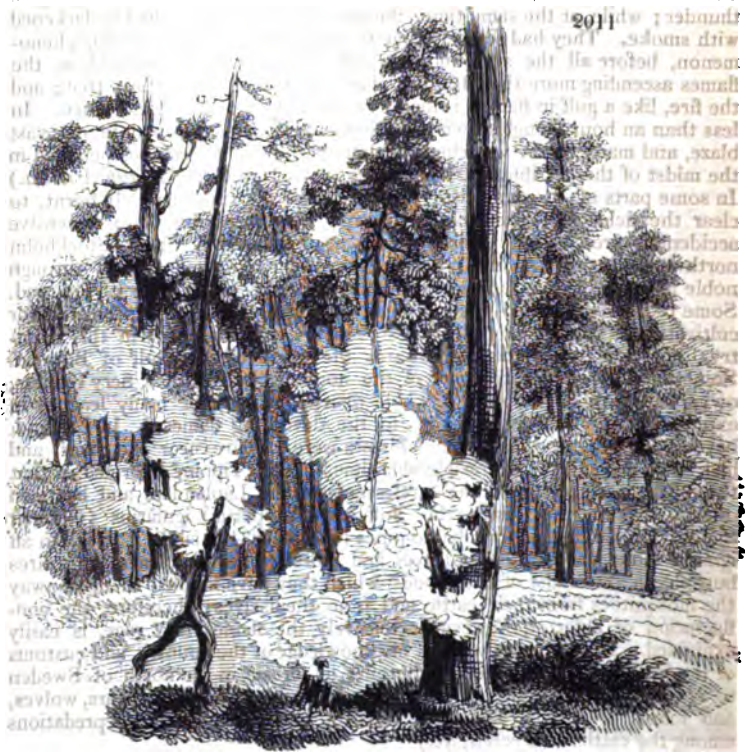

trees, and grubbing up their roots; but he adds that the practice is highly injudicious, as, by these indiscriminate conflagrations, the land is not properly cleared, and "a very strong and noxious plant, called the fireweed," springs up every where, and exhausts the fertility of the soil. The appearance of a burning forest is one of the most fearful and sublime objects that can be imagined, and has been powerfully described by Cooper in *The Pioneers*, and also by Galt in *Laurie Todd*. "The flames leap from tree to tree, and winding up to their tops, throw out immense volumes of fire from thick clouds of smoke, that hang over the burning mass, while the falling trees come down with most tremendous crash." The following account of one of these fires, which was more than usually destructive, is extracted from Mr. M'Gregor's book: — "In October, 1825, upwards of a hundred miles of the country, on the north side of the Miramichi river, became a scene of the most dreadful conflagration that has, perhaps, ever occurred in the history of the world. In Europe we can scarcely form a conception of the fury and rapidity with which the fires rage through the American forests during a dry hot season, at which time the underwood, decayed vegetable substances, fallen branches, bark, and withered trees, are as inflammable as a total absence of moisture can make them. When these tremendous fires are once in motion, or at least when the flames extend over a few miles of the forest, the surrounding air becomes highly rarefied, and the wind naturally increases it to a hurricane. It appears that the woods had been, on both sides of the north-west branch, partially on fire for some time, but not to an alarming extent until the 11th of October, when it came to blow furiously from the north-west, and the inhabitants on the banks of the river were suddenly alarmed by

a tremendous roaring in the woods, resembling the incessant rolling of thunder; while, at the same time, the atmosphere became thickly darkened with smoke. They had scarcely time to ascertain the cause of this phenomenon, before all the surrounding woods appeared in one vast blaze, the flames ascending more than 100 feet above the top of the loftiest tree; and the fire, like a gulf in flames, rolling forward with inconceivable celerity. In less than an hour Douglastown and Newcastle were enveloped in one vast blaze, and many of the wretched inhabitants, unable to escape, perished in the midst of this terrible fire." (*Sketches of the Mar. Col. of British America.*) In some parts of Sweden, also, the pines and firs are purposely burnt, to clear the fields for agricultural purposes; but there are also extensive accidental fires. Dr. Clarke, describing his journey from Stockholm northward, says: "As we proceeded to Hamrange, we passed through noble avenues of trees, and saw some fine lakes on either side of the road. Some of the forests had been burned, by which the land was cleared for cultivation. The burning of a forest is a very common event in this country; but it is most frequent towards the north of the Gulf of Bothnia. Sometimes a considerable part of the horizon glares with a fiery redness, owing to the conflagration of a whole district, which, for many leagues in extent, has been rendered a prey to the devouring flames." In Lapland, beyond Tornea, he adds, "some forests were on fire near the river, and had been burning for a considerable time." Mr. Tipping informed us that these fires were owing to the carelessness of the Laplanders and boatmen on the rivers, who, using the *Bolëtus* (*Polyporus*) *igniarius* (German tinder) for kindling their tobacco-pipes (see p. 1834.), suffer it to fall in an ignited state among the dry leaves and moss. They also leave large fires burning in the midst of the woods, which they have kindled to drive away the mosquitoes from their cattle and from themselves; therefore, the conflagration of a forest, however extensively the flames may rage, is easily explained. Yet Linnæus, with all his knowledge of the country, and customs of the inhabitants, attributed the burning of forests in the north of Sweden to the effects of lightning. During these tremendous fires, the bears, wolves, and foxes, are driven from their retreats, and make terrible depredations among the cattle." (*Travels, &c.*)

Diseases. The pine and fir tribe are subject to some diseases, and more particularly to the flow of resin, in consequence of being wounded by pruning when the sap is in active motion in spring. They are also affected by cancerous excrescences; and the wood is liable to become shaky; an evil which, of course, is not observed till the tree is cut down, and sawn into boards, when the annual layers are found to separate from each other. The larch is subject to a very peculiar disease, called pumping, which rots out the heart wood, and which we shall describe when speaking of that tree.

Insects. Mr. Westwood, to whom we are indebted for this article, observes, that the attacks of the insect tribes upon the genus *Pinus* are not, in this country, so prejudicial as in Sweden and some parts of Germany; where, owing to their very great extent, the pine forests are of such vast importance. Hence it is that in these countries the investigation of the habits of the different species of insects which attack the pine and fir tribe has been pursued with much more care than among us. We shall avail ourselves in this article of the most recent labours both of Continental and English authors, adding thereto some original matter, which we have not found noticed in their works.

The insects which attack the different species of *Pinus* may be divided into two classes; viz., internal feeders, and external feeders. The former may again be separated into those which burrow into the wood, and those which merely reside beneath the bark: not, indeed, that the latter are less injurious than the former; because, as in the elm-destroying *Scolytus*, the presence of great numbers of subcortical species causes the death of a tree as speedily as those which strip it of its leaves, or burrow into its solid substance; and, indeed, often more speedily.

Of the internal Feeders which bore into the solid Wood, the species of the genus *Sirex* of Linnaeus (*Urocerus Geoffr.*); belonging to the order Hymenoptera, are amongst the largest. In the winged state, they are comparatively innocuous. They are often as large as hornets; and some of the species are coloured similarly to those insects. They especially abound in cold and mountainous regions, where the pines and other coniferous trees are abundant; and during flight they make a loud humming noise. The best known species, *Sirex gigas* Linn., attacks *Abies excelsa* (*Homomitalis, Fursten.*) It is very common in Sweden, and in the Alps and Pyrenees. The females are provided with a very strong horny ovipositor, by means of which they deposit their eggs in the crevices of the trees. The larvæ, when hatched, burrow into the wood in various directions: they are fleshy and cylindrical, with a scaly head, six very minute pectoral feet, and a horny point on the upper side of the extremity of the body. (*Latr. Hist. Génér.*, xiii. p. 149.) "The species of the genus *Sirex*, probably all of them in the larva state, have no appetite but for ligneous food. Linnaeus has observed this with respect to *S. spectrum* and *Camelus*; and Mr. Marsham, on the authority of Sir Joseph Banks, relates (*Linn. Trans.*, x. 408.) that several specimens of *S. gigas* were seen to come out of the floor of a nursery in a gentleman's house, to the no small alarm and discomfiture of both nurse and children." (*Introduct. to Ent.*, i. p. 231.) In this case, it is evident that the floor of the room must have been recently laid down, the planks containing the sireses either in the larva or pupa state; and that they made their appearance on attaining the imago form. Linnaeus (*Syst. Nat.*, ii. p. 929.) says of *Sirex spectrum*, "Habitat in lignis putridis antiquis Pini et Abietis." Wm. Raddon, Esq., has lately forwarded to the Entomological Society of London specimens of *Sirex juvencus*, another large species, of a fine blue colour in the female; accompanied by specimens of the wood of a fir tree from Bewdley Forest, Worcestershire, perforated and destroyed by the larvæ of this insect; some of which still remained in the wood. Of this tree, 20 ft. were so intersected by the burrows, that it was fit for nothing but fire-wood; and, being placed in an outhouse, the perfect insects came out every morning, five, six, or more each day. The females averaged one in twelve for the first six weeks; but afterwards became more plentiful, and continued to make their appearance until the end of November; females being only produced during the last two or three weeks. (*Trans. Ent. Soc. London*, i. p. lxxxv.) At the same meeting of this Society, it was also stated by the Rev. F. W. Hope, that, in his father's grounds at Netley, in Shropshire, the *Sirex* generally attacks those trees which have passed their prime; and that the Weymouth pines are more subject to their attacks than the Scotch pines. These statements will be quite sufficient to disprove the recently published view of the Count de Saint Fargeau (*Hist. Nat. Hymenopt.*, tom. i.), that the *Sircidæ* are parasitic upon other insects, like the *Ichneumonidæ*. It is, however, amongst the coleopterous insects that the greatest numbers of pine-boring species are found; and of these a considerable portion belong to the family of the weevils (*Curculionidæ*), one of the largest British species of which is thus injurious: it is the *Hyllobius abietis* of Germar (*Curculio abietis* of Linnaeus, *Curculio pini* Marsham, &c.). This insect varies in length from half to three quarters of an inch. It is of a pitchy black colour, varied with yellowish pile. Fortunately, however, in this country it is but of rare occurrence; although in Scotland, and especially in Sweden, it is very abundant and destructive. A memoir upon the habits of this beetle has been published by Mr. W. S. McLeay, in the *Zoological Journal*. A great failure of the young fir and larches on Lord Carlisle's estates in Scotland had taken place, which was at first thought to be occasioned by mice, so completely was the bark destroyed. The wood warden was, however, subsequently convinced that the mischief was produced by insects, of which specimens were forwarded to Mr. W. S. McLeay. The destruction was more rapid when the roots of the Scotch fir were in a state of decay; a circumstance strongly supporting the opinion that

the author of the mischief was an insect; for mice would only attack the green and healthy bark: and, indeed, the insects proved to be no other than the *Hyllobius abietis*. According to Rossmässler, it is chiefly young trees of *Pinus sylvestris* and *Abies excelsa* which are attacked by this species. Another species of the same genus is the *Hyllobius pinastri* *Dejean*, which, according to Gyllenhal (*Ins. Succ.*, iii. 168.), "habitat in frondibus et ligno Pini et Abietis."

The species of another genus of weevils (*Pissodes Germar*) are also very destructive to different species of the pine and fir tribe. Gyllenhal describes five species; three only of which have been detected in this country, and all of them are here of great rarity; namely: *P. pini* *Linna.*, *P. notatus* *Fabr.*, and *P. pineti* (*Fabricii* *Leach*). An interesting memoir has recently been published by Dr. Ratzburg in the last volume of the *Nova Acta Naturæ Curiosorum* (vol. xvii. p. 424.), in which the habits of the two first-named species are given in detail. Fig. 2012. shows the mode

in which young trees are attacked; the tree being four years old when the drawing was made. The passage of the larva is here marked with the letter *a*; the abode of the pupa, or cocoon, as it may be termed, with the letter *b*; and *c* indicates the opening through which the perfect insect escapes. Gyllenhal gives *Pinus sylvestris* and *Abies excelsa* as the habitat of *Pissodes pineti*; *Abies excelsa*, as that of *Pissodes Herefynæ*, notatus, and piniphilus; but he describes the economy of *Pissodes pini* as being more general: "Habitat in arboribus resinosis, præsertim in abietis frondibus et ligno nuper cæso, frequens." (*Ins. Succ.*, i. pars 3. p. 66.) Dr. Heer has also recently described the metamorphoses of another species of the same genus (*Pissodes piceæ Illiger*), of which many larvæ and pupæ were discovered in the trunk of *Picea vulgaris* in the middle of June, 1835. (*Observ. Entomol.*, 1836, p. 27. tab. iv. b.) There is also another tribe of small beetles, very nearly allied to the family *Curculionidæ*, but in which the head is not produced into a muzzle, of which several of the species are very destructive to the trees of this genus. They constitute the genus *Hylurgus* of Latreille, and were included by Fabricius in his genus *Hylésinus*. The species *H. piniperda*, *ligniperda*, *ater*, *palliatus*, and *angustatus*, are recorded as inhabitants of fir plantations. Rossmässler gives the first of these as an enemy to old trees of *Abies excelsa*;

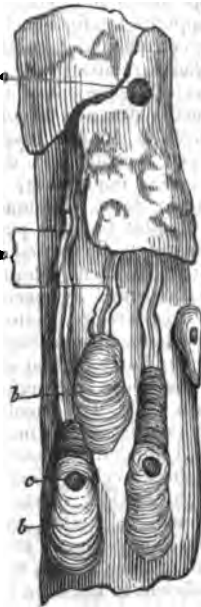

2012

but Gyllenhal says of it, "Habitat in Pini sylvestris ramulis, quos perforat et exsiccatur etiam in ligno et sub cortice, frequens." The following observations and figures relative to the economy of this species were communicated by Dr. Lindley to Mr. Curtis:—"For the purpose of examining its proceedings more narrowly, I placed a shoot of the Scotch pine under a glass with the insect. In about three hours afterwards, it had just begun to pierce the bark of the base of one of the leaves. Its mandibles seemed chiefly employed, its legs being merely used as a means of fixing itself more firmly. Four hours after, its head and thorax were completely buried in the shoot; and it had thrown out a quantity of wood, which it had reduced to a powder, and which nearly covered the space under the glass. In sixteen hours more, it was entirely concealed, and was beginning to form its perpendicular excavations, and was busily employed in throwing back the wood as it proceeded in destroying it. There were evidently two kinds of this sawdust; part consisting of shapeless lumps, but the greater portion of very thin semitransparent lamellæ, or rather shavings. I now examined it every day, till the fifth; when I found it had emerged through the central buds, at

about 1 in. from where it had first entered." (*Curtis Brit. Ent.*, vol. iii. p. 104.) Fig. 2013. shows three longitudinal sections, or shoots, of Scotch pine, with the various perforations of the insects: *a*, where it commences; *b*, the aperture which it makes after it has finished its excavation; and *c*, the end of the first and beginning of a second excavation." (*Curtis*, loc. cit.) Stephens states that it is extremely detrimental to the leading shoots of the Scotch pine, perforating them longitudinally and transversely, and also injuring the wood and bark of the trunk. This insect (*d*) is about one sixth of an inch in length, of a cylindrical form, and black colour, with lineate-punctate elytra. It varies to a pitchy red or dull buffish colour.

Dr. Ratzeburg has given numerous details relative to the history of this species, and *H. ater* and *angustatus*, in the memoir above referred to; and Dr. Rossmässler recommends that trees infested with them to a great extent should be cut down and burned, as the only means of saving the rest of the plantation or forest.

Many species of longicorn beetles also inhabit the pine forests, amongst which *Spondylis buprestoides* *Fabr.* (*Gyll. Ins. Suec.*, iv. p. 117.), *Priõnus depõarius* *Fab.* (*Gyll.*, p. 116.), *Lãmia* (*Acanthõcinus*) *Ædilis* *Fabr.* (*Ædilis montãna* *Serville*, *Gyll.*, p. 54.), and *Rhãgium inquisitor* *Fabr.*, are particularly to be mentioned; the last, according to Rossmässler (p. 77.), attacking old trees of *Abies excelsa*, but committing less damage than the other tribes. Some of the species of the genus *Callidium* are, however, much more obnoxious. *C. bájulus* inhabits the wood of the *Abies excelsa*, in which the larva is nourished; it is also very abundant in old posts and rails of deal, in which the female deposits her eggs by means of her elongated telescope-like ovipositor, and also in the rafters of houses; and Mr. Westwood has been informed by Mr. Stephens, that, at his residence in South Lambeth, it became necessary several times to cover afresh the leaden part of the roof, in consequence of the insects which had been bred in the rafters eating their way through the leaden sheeting by which they were protected.

The proceedings of another species of the same genus (*Callidium violãceum*) have been described by the Rev. W. Kirby in the fifth volume of the *Transactions of the Linnæan Society*. This insect feeds principally on fir timber, which has been long felled, without having had the bark stripped off; a circumstance of considerable importance; as, by taking off the bark as soon as the trees are felled, the attacks of various insects, subsequently to be noticed, might be prevented. The larva, as soon as hatched, proceeds in a serpentine direction, filling the space which it leaves with its excrement, resembling sawdust, and thus stopping all ingress to enemies from without. It is chiefly beneath the bark that it constructs its galleries, which are more tortuous and irregular as it increases in size: but, previously to assuming the pupa state, it burrows into the solid wood to the depth of 2 in. or 3 in., and there becomes an inactive pupa; the perfect insect generally appearing in the months of May and June, gnawing its way out opposite to the hole by which it descended into the wood.

The *internal Feeders* which are found under the Bark, or the subcortical tribes of beetles, are, however, those by which we find the greatest extent of injury committed upon trees of the pine and fir tribe. The genus *Tõmicus* belongs to this tribe, containing numerous species, which, on account of the peculiar habits and mode of burrowing, have been fancifully termed printer, or typographer, beetles. The type of this genus is the *Dermõstes typõgraphus* of Linnæus; a small cylindrical beetle, one fourth of an inch

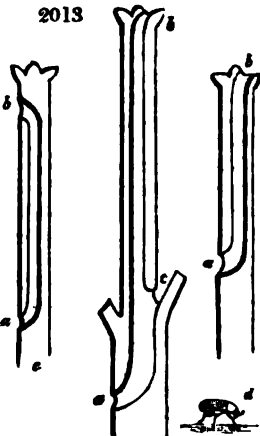

long, and of a pitchy black or reddish colour, with long yellow hairs; the elytra being obliquely truncate, with six teeth on each side, behind the margins of the truncation. This beetle is, fortunately, very rare in England; but in Germany it has, at various times, abounded to so great an extent, that the great pine forests have suffered very severely. "The insect, in its preparatory state, feeds upon the soft inner bark only; but it attacks this important part in such vast numbers (80,000 being sometimes found in a single tree), that it is infinitely more noxious than any of those that bore into the wood; and such is its vitality, that, though the bark be battered, and the tree plunged into water, or laid upon the ice or snow, it remains alive and unhurt. The leaves of the trees infested by these insects first become yellow; the trees themselves then die at the tops, and soon entirely perish. Their ravages have long been known, in Germany, under the name of wurm-trökniss (decay caused by worms); and, in the old liturgies of that country, the animal itself is formally mentioned under its vulgar appellation, the 'Turk.' This pest was particularly prevalent, and caused incalculable mischief, about the year 1665. In the beginning of the last century, it again showed itself in the Harz forests. It reappeared in 1757, redoubled its injuries in 1769, and arrived at its height in 1783; when the number of trees destroyed by it, in the above forests alone, was calculated to amount to a million and a half; and the inhabitants were threatened with a total suspension of the working of their mines, and, consequently, with ruin. At this period, these insects, when arrived at the perfect state, migrated in swarms, like bees, into Suabia and Franconia. At length, between the years 1784 and 1789, in consequence of a succession of cold and moist seasons, the numbers of this scourge were sensibly diminished. It appeared again in 1790; and, so late as 1796, there was great reason to fear for the few fir trees that were left." (*Wilhelm's Recreations in Nat. Hist.*, quoted by *Latreille* and by *Kirby and Spence*.)

Roesmüssler gives the old trees of *Abies excelsa* as the habitat of this species; but Gyllenhal adds *Pinus sylvestris*; justly calling the insect "pinetorum pestis." (*Ins. Suec.*, i. p. 111. pag. 351.) Its passages are so similar to those of *Scolytus destructor* (figured in p. 1388.), that we have not thought it necessary to give a representation of them. Its proceedings are also very similar to those of the *Scolytus* (to which genus, indeed, it is very nearly allied); so that it would be as erroneous to attribute the destruction of the German forests to other primary causes, and to consider the *Tomicus typographus* as a secondary cause, as it is to deny that the *Scolyti* are the cause of the destruction of the elms around London. Wilhelm, indeed, expressly states that the misplaced confidence which many persons entertained that the insects attack only trees already injured, and that their ravages are suspended by the insects themselves, has lost many hundreds of trees. The remedies suggested in a preceding page (1390.), for the destruction of *Scolyti*, may also, to a great extent, be advantageously adopted for the extermination of the *Tomici*.

Roesmüssler, Bechstein, and Ratzeburg detail the natural history of several other species of this genus of beetles. *T. chalcographus* attacks old trees of *Abies excelsa*; *T. pinastri*, those of *Pinus sylvestris*; *T. abietipérda*, *Pinus Picea*; *T. Laricis* inhabits *Larix communis*. *T. 8-dentatus* and *T. suturalis* are also pine feeders; as is also *T. bidens*. Fig. 2014. represents the workings of the last-named species beneath the bark of a four-years-old fir tree.

Tomicus chalcographus Gyll. (*6-dentatus* Oliv.) has not hitherto been recorded as a native of this country: it must, however, have been long since introduced from the north, in the fir trees so constantly imported. Mr. Spence has recently communicated specimens



to the Entomological Society of London, discovered in a living state, at the end of the month of March, beneath the bark of a foreign fir tree, which was being prepared at Southampton for a mast; several of the insects being at the time just emerging from the pupæ, and others still larvæ. The perfect insect is small (about 1 line long), pitchy black, with castaneous elytra, retusely truncate behind, with three teeth on each side. The galleries made by the female are horizontal, like those of the genus *Hylésinus* (not vertical, like those made by the *Scólyti*), though very often more or less curved or oblique. (See fig. 2015.; in which *a* represents the insect of the natural size.)



a 2015

Dr. Heer has described another species belonging to the same genus, under the name of *Bóstri-chus cémbrae*, which is found beneath the bark of *Pinus Cémbra*. In the month of July, 1835, this species, in all its states, was discovered in the above-mentioned situation, at an elevation of 5700 ft. above the level of the sea, "in valle Beversiana." (*Observ. Entomol.*, p. 28.)

I'ps ferruginea is another coleopterous insect; of small size and depressed body, which is found beneath the bark of the fir.

The external Feeders consist, for the most part, of the caterpillars of various species of lepidopterous insects, together with those of a few of the saw-flies. Amongst the *Sphingidæ* is to be noticed the *Sphinx pinástri* of Linneæus, a fine, but in this country very rare, species, the caterpillar of which feeds upon *Abies excélsa*, and on *Pinus sylvéstris*, *P. Stróbus*, &c. This caterpillar is smooth, and at first entirely yellow; but it finally becomes of a fine green, with a brown dorsal line. The upper side of the body is terminated by a curved, black, and horny tail. The perfect insect is of an ashy colour; the fore wings being marked with three short, longitudinal, black lines. It is nearly $3\frac{1}{2}$ in. in expansion of the wings. Bouché (*Garten Ins.*, p. 63.) states that it is sometimes very destructive, when it abounds to a considerable extent, occasionally entirely stripping the Weymouth pine of its leaves.

Amongst the Linneæan *Bómbyces*, *Eútricha pini* is often, on the Continent, a perfect land scourge, entirely stripping many of the pines, especially the Weymouth, of their leaves. This large moth is of a greyish colour, with an irregular reddish bar across the fore wings, and a small white discoidal spot. The caterpillar is hairy, and varied with white, brown, and grey; with the anterior segments ornamented with two blue transverse stripes, and some red spots on the sides. The moth and caterpillar are beautifully figured by Curtis (*Brit. Ent.*, pl. 7.), who observes, in his new edition, that the hairs with which the latter are clothed cause excessive irritation when handled. The caterpillars were found at the end of June; and the moths appeared at the end of the following month. Rossmässler gives old trees of *Pinus sylvéstris* as the habitat of this species. The irritating powers of this insect are, however, far surpassed by the celebrated *pityocampa* of the ancients, which is regarded as the caterpillar of the *Bómbyx Pityocámpa Fabr.* (genus *Cnethocámpa Stephens*), which resides upon the fir, the hairs of which are said to occasion a very intense degree of pain, heat, fever, itching, and restlessness. By the Cornelian law, "De Sicariis," the punishment of death was inflicted upon those who should, with malice prepense, administer either the *pityocampa* or the *buprestis*:—"Qui buprestem vel pityocampem, tanti facinoris consci, aut mortiferi quid veneni ad necem accelerandam dederit, judicio capitali et pœna legis Corneliæ afficiator." This moth belongs to the same modern genus as the processionary moth, before described. (See p. 1820.) The moth is of a greyish colour, with three darker transverse bars; and the caterpillars are dark or dusky grey, with a white lateral line. They are processionary in their movements, but not so regularly so as the *Cnethocámpa processionæa*.

The caterpillars of *Psilura monacha* (or the black arches moth) occasionally feed upon the old trees of *Pinus sylvestris*, according to Rossmässler.

In the family Lithosiidæ, *Lithòsia aurèola* feeds upon the *Abies excelsa* and on *Pinus sylvestris*; *P. complana*, occasionally upon the latter; *P. depressa*, upon the same; and *P. quadra*, occasionally on the fir.

Amongst the Noctuidæ, the most destructive species is the *Achæta sprèta* Fabr. (*Noctua piniperda* Kob.), a species of considerable rarity in England, which is recorded by the Continental writers as occasionally doing very great injury in the pine forests. It is figured, both in the winged and larva state, by Mr. Curtis (*Brit. Ent.*, pl. 117.); who remarks that the caterpillars, "like those of *Sphinx pinastri*, *Bupalus piniarius*, &c., are striped in a way to resemble the leaves upon which they feed: they are full grown about the end of June, when they descend into the earth, and become chrysalides; and the following March the fly appears. At this time multitudes, no doubt, are destroyed by the inclemency of the season, thereby preventing the serious consequences that occur when such a check is withheld by the great Author of nature, who has protected them with a clothing that has a greater resemblance to hair than scales, and, no doubt, is better adapted to their wants, since we find the same in many other moths which make their appearance at an early period of the year." Rossmässler gives the old trees of *Pinus sylvestris* as the habitat of this species. *Noctua* (*Dypterygia* Steph.) *pinastri* Linn. feeds on several species of *Rumex*. In the family Geometridæ, the *Geometra* (*Bupalus* Leach) *piniaria* Linn. is a great pest; and it is fortunate that it is of considerable rarity in this country. The following report, addressed by the inspector of forests at Strasburg to the bureau of the administration of woods and forests at Paris, and published in Silbermann's *Revue Entomologique*, will show the extent of damage which this insect is capable of committing:—"At the end of 1822, a malady occurred amongst the fir trees in the Forest of Hagenau, one of very considerable extent, near Strasburg, extending over 7000 hectares. The firs, covering a space of about 40 hectares, were at first observed to have their leaves of a yellow colour, and to be dried in their appearance. The cause of this malady was sought for in vain; but, during the following year, it was so much increased, that more minute researches were made; and it was at length discovered that it was owing to the attacks of the larva of the moth, which commenced its ravages at the beginning of the month of May, passing from tree to tree, until the month of October, when it descends into the ground to undergo its transformations. The trees attacked in 1832 are now entirely destroyed, without hope of future vegetation." Stephens gives *Abies excelsa* and *Pinus sylvestris* as its habitats. (*Illustr. Brit. Ent.*, iii. p. 147.) Bouché states that the most advantageous means of preventing its attacks is, to hunt for and destroy the chrysalides in the winter, under the moss at the roots of the attacked trees. The caterpillars of *Ellòpia fasciaria* (*Geometra* Linn.) and *Thèra variata* also feed upon different species of *Pinus*; the latter preferring *Picea vulgaris* and *Abies excelsa*. De Geer (*Mémoires*, tom. ii. t. 9. f. 10—12. has figured the transformations of several small moths, the caterpillars of which feed within the cone of the fir. *Phalæna Tinea pini* Retz., *ibid.*, fig. 14. (fig. 2016. is a cone enclosing two caterpillars; *a a* representing the excrement ejected from the cone); *Phalæna strobilòrum pini major* Retz., *ibid.*, fig. 15; *Phalæna strobilòrum pini minor* Retz., tom. i. pl. 22. fig. 27.; *Phalæna gemmarum pini* Retz. There are several other small moths which are also destructive to the young cones and buds of the fir; namely: *Tórtrix Buoliàna* (*Ratzeburg* and *Rossmässler*) and *T. Turionàna* (genus *Orthotænia* Stephens). Mr. Curtis bred the latter from caterpillars which feed on the shoots of the Scotch pine. Ortho-



6 z 2

tæ'nia comitana is also common amongst fir trees. *Eudorea resinae Haw.* frequents the trunks of firs and pines. De Geer has figured the natural history of *Orthotæ'nia resinella Linn.* The caterpillars of this beautiful little moth reside in resinous galls, which they produce at the tips of the young shoots of the fir. Fig. 2017. exhibits one of these galls; in which *a* represents the withered bud at its extremity; *b*, one of these galls opened, showing the internal cavity enclosing the caterpillar; and *c*, the moth. The pseudo-caterpillars of several of the species of the genus

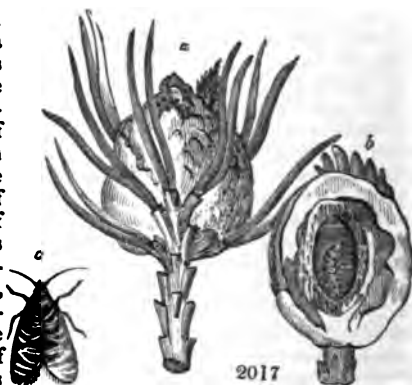

Lophyrus (belonging to the family of the saw-flies, *Tenthredinidæ*) also feed upon the leaves of the pine. De Geer has given full details of their history. (*Mémoires*, tom. ii. pl. 36.) The males of this interesting genus are distinguished by having the antennæ very deeply bipectinated. *L. pini*, according to Rossmässler, is attached to old trees of *Pinus sylvestris*. The singular hymenopterous genus *Xyèla* of Dalman, was named *Pinicola* by Brebisson, in consequence of the species being found exclusively upon the pine.

In addition to the preceding, there are numerous other small insects, belonging to different orders, which inhabit trees of the genus *Pinus*; namely, *Aphis pini* and *pineti*, *Eriosoma abietis*, *Coccus abietis*, *Psylla abietis* and *pini*, and *Mantinea (Pachymerus) abietis*, belonging to the Linnæan order Hemiptera; a small midge (*Cecidomyia pini*), which produces small galls on the young stems in which its larva resides (*De Geer, Mém.*, tom vi. t. 26.): and belonging to the Coleoptera are, *Cryptocéphalus pini*, *Brachyonyx indigena*, *Brachyderes incanus*, and *Mágdalis violáceus* (all of whose histories are detailed by Ratzeburg); as well as *Cyphon pini* and *Malthinus Pinicola*.

Parasites and Epiphytes. Among the plants which live on the pine and fir tribe, may be included the mistletoe in Europe, and the *Arceuthobium Hook. (Viscum Oxycedri Dec.)* in North America: the former, we believe, has been chiefly found on *P. sylvestris* and on the silver fir, and the latter on *P. Banksiana* and *P. ponderosa*. For the following enumeration of Fungi that live on the bark, or on the decaying wood, of the pine and fir tribe, we are indebted to the Rev. M. J. Berkeley:—

Fungi. The natural order Coniferæ is very rich in Fungi, and produces many that are peculiar to it, though it has likewise a few species which are found on trees of other orders. We shall first notice those which grow upon species belonging to the genera *Pinus*, *Abies*, and *Larix*, treating of those which belong to other Coniferæ under their respective genera. It is probable that many pines and firs have species peculiar to them; but, though this is well known with regard to a few Fungi, authors have, in general, so loosely indicated the kinds which produce particular Fungi; and the terms *pinicola* and *abietina* are so often applied inaccurately, that it is not always possible to speak decidedly on the subject.



2018

Upon the wood of different firs and pines, the following are among the more interesting or most general species observed in this country:—*Agaricus rutilans Schaff.*, syn. *Xerampelinus Sow.*, t. 31., and our fig. 2018., is remarkable for its rich crimson red downy pileus, tinged occasionally with olive brown, and its yellow floccoserrated gills. This species occasionally occurs on trees of other natural orders. *A. Iris Berk. Eng. Fl.*, v. p. 56.,



2019

with a downy sky-blue pileus; *A. campanella* *Batsch.*, syn. *A. caulinãlis* *Sow.*, t. 163., and our fig. 2019; *A. lepidus* *Fr.*, syn. *A. squamõsus* *Schaff.*, t. 29., and our fig. 2020. Monstrous forms of this fungus occur in dark situations, with or without a pileus, exactly analogous to certain states of *Polyporus squamõsus*. Such are figured by Schæffer at t. 249. and 249., and by Sowerby at t. 382., under the name of *A. tubæfõrmis*. *A. põrrigens* *Pers. Syn.*, p. 480., found by Herr Klotzsch near Inverary; *A. flavus* *Schaff.*, t. 35., and our fig. 2021. *Merulius pulverulõntus* *Fr. El.*, v. i. p. 60., syn. *Auriculãria pulverulõnta* *Sow.*; one of the species known under the name of dry rot; first found at Ash Hill, in Norfolk, on fir beams in a wall. *Dædãlea sepiãria* *Wulf.*, syn. *Agãricus boletifõrmis* *Sow.*, t. 418.; found upon unsquared deals in a Thames dock. *Dædãlea abietina* *Fr. Syst. Myc.*, i. p. 334., *Agãricus abietinus* *Bull.*, t. 442.; a nearly allied species, found in a similar locality at Glasgow. Possibly both these have been imported into our dockyards. *Polyporus cæsius* *Fr. Syst. Myc.*, v. i. p. 360., syn. *Bolëtus albidus* *Sow.*, t. 226.; remarkable for turning blue when bruised; a property which exists in an eminent degree in several *Bolëti*, and appears to arise from a chemical change taking place in the juice of the plant when exposed to air. *Pol. irregularis* *Klotzsch*; syn. *Bol. irregularis* *Sow.*, t. 423., *Pol. amõrphus* *Fr. Syst.*, i. p. 364., *Pol. abietinus* *Pers. Syn.*, p. 541., *Grev. Sc. Cr. Fl.*, t. 226.; a very beautiful species, elegantly tinged with violet. *Pol. pinicola* *Fr. Syst. Myc.*, v. i. p. 372.; found on pine trunks in Scotland, by Mr. Arnott. *Pol. undãtus* *Pers. Myc. Eur.*, v. ii. p. 90. t. 16. f. 3; *Pol. incarnãtus* *Fr. Syst. Myc.*, v. i. p. 379.; *Pol. armeniacus* *Berk. Eng. Fl.*, v. v. p. 147., a beautiful buff and white species, found amongst the treasures of the collection of Capt. Carmichael. *Ipex pëndulus* *Fr. El.*, v. i. p. 143.; syn. *Hýdnum pëndulum* *Alb. et Schw.*, t. 6. f. 7.; *Thelëphora sanguinolõnta* *Alb. et Schw.*, p. 274., *Grev.*, t. 225., and our fig. 2022.; *Thel. amõrpha* *Fr. El.*, v. i. p. 183. *Thel. lactescens* *Berk. Eng. Fl.*, p. 167., and *Brit. Fungi*, No. 21.; remarkable for distilling drops of milk when wounded, which, in taste and smell, resembles that of *Ag. quiëtus*. This species occurs also on the elm. *Thel. gigantëa* *Pers. Myc. Eur.*, v. i. p. 150.; *Thel. livida* *Fr. Syst. Myc.*, v. i. p. 447. *Thel. puteãna* *Schum.*, *Fr. Syst. Myc.*, v. i. p. 448.; a peculiarly hygrometric fungus, which occurs in houses. When placed, after being gummed on paper and preserved in the herbarium for several weeks, in the cupboard where the fungus was first found, and where it had been entirely destroyed by a solution of corrosive sublimate; though the woodwork, which, in consequence, in an unusually damp season, had before been constantly dripping, was quite dry; it, in 12 hours, recovered its original fleshy appearance, and was studded with drops of coffee-coloured moisture. (*Berk. in Mag. of Bot. and Zool.*, v. i. p. 44.) *Calõcera viscõsa* *Fr. Syst. Myc.*, v. i. p. 486.; syn. *Clavãria viscõsa* *Pers. Comm.*, t. 1. f. 1. *Peziza calycina* *Schum.*, syn. *P. pulchëlla* *Grev. Fl. Ed.*, p. 421.; extremely common on fallen branches of the larch. *Pez. búccina* *Pers. Syn.*, p. 659.; *Pez. sanguinea* *Pers. Syn.*, p. 657.; *Pez. xanthostigma* *Fr. Obs.*, i. p. 166.; *Pez. flexëlla* *Fr. Syst. Myc.*, v. ii. p. 152.; *Ditiola radicãta* *Fr. Syst. Myc.*, v. ii. p. 170., and our fig. 2023. *Helõtium radicãtum* *Alb. et Schw.*, t. 8. f. 6.; a very beautiful, but destructive, fungus, growing on boards of *Pinus sylvéstris*. The mucedinous roots insinuate themselves between the fibres of the wood, and, creeping far and wide, separate, and at length render the substance soft and rotten, by exhausting its nutritive particles. Besides which, from the erumpent mode of growth of this fungus, the wood is rendered pervious to the rain, and, in a few years, becomes brittle and perishes. The roots are perennial, and put forth fresh



2020



2021



2022



2023

individuals every year, which are in perfection after the spring rains. *Stictis parallela* Fr. *Syst. Myc.*, v. ii. p. 197. A curious undescribed species (*Stictis nivea*) is found in great abundance near Paris, in the Bois de Boulogne, on the fallen leaves of *Pinus maritimus*, and is most probably to be found in some of the London nurseries. *Næmatelia*

2024



2025

encéphala Fr. *Syst. Myc.*, v. ii. p. 227.; *Dacrýmyces stillatus* Nees, *Grev.*, t. 159., and our fig. 2024.; *Agýrium rufum* Fr. *Syst. Myc.*, v. ii. p. 232.; *Nidularia crucibulum* Fr. *Syst. Myc.*, v. ii. p. 299., *Grev.*, t. 34., and our fig. 2025. *Sphæria gelatinosa*

Tode Fung. Meck., ii. p. 48. f. 123, 124. a very rare species. *Sp. abietis* Fr. *Syst. Myc.*, v. ii. p. 398.; *Sp. strigosa* Alb. *et Schw.*, t. 5. f. 7.; *Sp. sordaria* Fr. *Syst. Myc.*, v. ii. p. 458.; appearing like a black scurfy stain on moist pine wood. *Sp. pilifera* Fr. *Syst. Myc.*, v. ii. p. 472.; remarkable for its hair-like orifice. *Lophium mytilinum* Fr. *Syst. Myc.*, v. ii. p. 533., *Grev.*, t. 177. f. 1., and our fig. 2026.; and *Lophium elatum* *Grev.*, t. 177. f. 2., and our fig. 2027.; are most curious and elegant



2026



2027

Fungi, resembling minute bivalve shells, placed with their frontal margin upwards. *Phacidium Pini* Schmidt, *Myc. Hest.*, ii. t. 2. f. 11.; on the bark of *Pinus sylvestris*. *Reticularia atra* Alb. *et Schw.*, t. 3. f. 3.; *Lycopér-*



2028

don fuliginosum Sow., t. 257.; *Ret. olivacea* Fr. *Syst. Myc.*, v. iii. p. 89.; remarkable for its beautiful olive-green sporidia. *Perichæna abietina* Fr. *Syst. Myc.*, v. iii. p. 191.; *Sphærocárpus sessilis* Sow., f. 258.; and *Pachnocybe ferruginea* Berk. *Eng. Fl.*, v. v. p. 334., syn. *Mucor ferrugineus* Sow., t. 378. f. 10.

Several species occur on the fallen cones; amongst which are: *Agaricus tenacellus* Pers. *Ic. Pict.*, t. 1. f. 3, 4., syn. *Ag. spinipes* Sow., t. 206., and our fig. 2028.; *Ag. consigenus* Pers. *Syn.*, p. 388. *Ag. sanguinolentus* Alb. *et Schw.*, p. 196.; a small but elegant species,



2029

distilling a claret-coloured fluid when broken, which often occurs on cones of the Scotch pine, though found also on the twigs of various trees. *Ag. strobilinus* Pers. *Syn.*, p. 393., and our fig. 2029., syn. *A. coccineus* Sow., t. 197.; which occurs, also, occasionally on twigs, as in our figure. *Hydnum auriscálpium* L., Sow., t. 267., *Grev.*, t. 196., and our fig. 2030.; on cones of *Pinus sylvestris*. *Peziza pineti* Batsch. *Cont.*, i. f. 140.; *P. confingena* Pers. *Syn.*, p. 634., *Grev. Fl. Ed.*, p. 425.; *Sphæria strobilina* Holl. *et Schm.*, Fr. *Syst. Myc.*, v. ii. p. 495.; *Hystèrium conigenum* *Moug. et Nest.*, No. 475.; on cones of the Scotch fir,

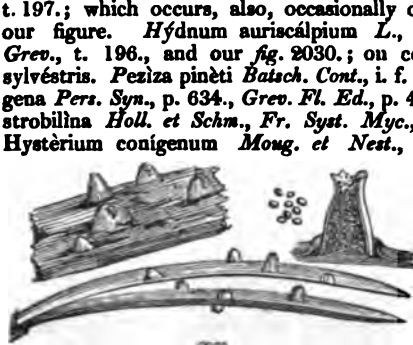

2030

confined to the upper and exposed portion of the scales. *Perichæna strobilina* Fr. *Syst. Myc.*, v. iii. p. 190., *Grev.*, t. 275.; between the scales of old cones of the spruce fir.



2031

On the leaves are produced: *Peziza subtilis* Fr. *Syst. Myc.*, v. ii. p. 157.; *Sphæria Pinastri* Dec. *Fl. Fr.*, v. vi. p. 133.; *Hystèrium Pinastri* *Schrad.*, Pers. *Syn.*, p. 28., *Grev.*, t. 60.

Æcidium Pini Pers. Syn., p. 213., *Grev.*, t. 7., and our *fig.* 2031.; on *Pinus sylvêstris*, occurring sometimes on twigs, and being then much larger. An allied species, *Æ. abiétinum*, is found, in Germany, on the spruce fir; and two on *Pinus Picea*, *Æ. columnàre* and *Æ. elátinum*. All are figured by Albertini and Schweinitz, in their fifth plate. The latter infests trees to such an extent, that they are known by the name of hexenbäume.



Many Fungi grow beneath the shade of Coniferæ; as *Agáricus hypothêjus Fr.*, syn. *A. limacinus Sow.*, t. 8., and our *fig.* 2032.; *A. multi-fórmis Schæff.*, syn. *A. térreus Sow.*, t. 76., and our *fig.* 2033.; *A. delici-ósus L.*, *Sow.*, t. 202., and our *fig.* 2034.; the reitzkers of the Germans,



is, as its name implies, a most delicious agaric, but not always to be eaten with impunity. It abounds in mucilaginous matter, and has, therefore, been recommended for pulmonary affections by M. Dufresnoy.



A. rufus Scop.; *A. bellus Pers.*; *A. maculátus Alb. et Schw.*, syn. *A. carnósus Sow.*, t. 246., and our *fig.* 2036.; *A. vulgàris Pers.*; and *A. limónius Fr.*, *Cantharéllus aurantiacus Wulf.*; a poisonous species, which must be carefully distinguished from the edible one, *C. cibàrius Fr.*, our *fig.* 2037. *Bolétus granulátus L.*, syn. *B. lactifluus With.*, *Sow.*, t. 420.



an esculent species, according to Persoon. *B. bovinus L.*; and *B. variegátus Swartz.* *Hýdnum imbricatùm L.*, *Grev.*, t. 71., and our *fig.* 2035.; and *H. compac-tum Pers.* *Theléphora terrêstris Fr.*; *T. laci-niàta Fr.*, syn. *Helvélla caryophyllæa Bolt.*, t. 173., and our *fig.* 2038.; and *T. byssóides Fr.*



Clavària abiétina Pers.; *Geoglóssum cucullátum Fr.*, syn. *Leótia mîtrula Grev.*, t. 81., and our *fig.* 2039. *Spathulària flávida Pers.*, *Grev.*, t. 165., and our *fig.* 2040. *Sphæ'ria capitata Holmk.*, syn. *Sphæ'ria agaricifórmis Sow.*, t. 354., and our *fig.* 2042., parasitic upon *Elaphómyces granulátus Fr.*; and *S. alutácea Pers.*, syn. *S. clavata Sow.*, t. 159., and our *fig.* 2044.; are both among the most curious and rare of British Fungi: and to these may



be added the interesting *S. laterítia Fr.*, developed upon agarics, which are so strangely altered by the parasite as to assume the form of a *Helvélla* or *Leótia*.

The branches of the larch, which are cut off for the purpose of thinning plantations, are frequently covered with *Agáricus mîtis Pers.*; and under the shade abounds *Bolétus laricinus Berk.*

The Study of the Species. The mode which we have followed in the study of the *Abiétinæ*, as in all the other orders and genera treated of in this work,

has been, first, to study the subject historically, that is, to ascertain what has been said of it in books; and, next, to study it practically, that is to compare the information and the plates given in books, with living plants. After perusing all the works we could procure on the subject, including Lambert's *Genus Pinus*, 2d edit., 2 vols, 8vo, and the third volume of that work (which, though only three or four copies have yet, August, 1837, been published, we have been very kindly favoured with the loan of by His Grace the Duke of Bedford), we took the first two volumes of Lambert's work, and that volume of Michaux's *North American Sylva* which contains the *Abiétinæ* of North America, in our hands, and visited Loddiges's arboretum, the Horticultural Society's Garden, Kew, Syon House, Dropmore, Whitton, Pains Hill, Mill Hill, White Knights, and the principal nurseries; and, from the study of the plants in these places, in connexion with the descriptions and plates in the books we have mentioned, we have arrived at the general conclusions which we shall now shortly lay before the reader, as preliminary to giving each genus, and its species and varieties, in detail.

In every arrangement of species and varieties, it appears to us that there ought to be two objects in view. First, to throw all the kinds into groups capable of being more or less distinctly defined; or, at all events, of being represented by one species as a type; such, for example, as the group *Sylvestres*, of the section *Binnæ*, which consists of species all more or less resembling the Scotch pine in foliage and in cones. The use of these groups is, to render the whole mass easily comprehended by any person who knows only a few of the species; and, secondly, when separating these groups into species and varieties, to give as prominent a place to all varieties and subvarieties that are truly distinct, as if they were species. Besides the argument which we have advanced in favour of throwing the kinds into groups, there are the important ones mentioned in Part II. of this work (p. 216.); viz. those of assisting a collector of trees to make a judicious selection, and of preventing a beginner in botanical studies from puzzling himself in finding out specific distinctions where none really exist. The reason why we wish to keep every variety and subvariety as distinct as possible is, that, in the practice of arboriculture, whether for useful or ornamental purposes, a variety is often of as much importance as a species, and sometimes, indeed, more so: for example, in *P. sylvéstris*, the Highland variety is known and acknowledged to produce timber of a superior quality to the common kind; and, in point of ornament, for situations where the common kind of Scotch pine is too large, the species may be represented by *P. (s.) p. Mughus nana*, which forms a beautiful little bush.

In studying the *Abiétinæ* from living trees, the terminal buds, the number of leaves in a bundle or sheath, and their position on the branch, the sheaths being persistent or deciduous, and the form of the cones, and the character of their scales, are the principal points by which, we think, one species or group of kinds can be distinguished from another. Thus, in *Pinus*, all the varieties of *P. sylvéstris* have short-pointed resinous buds, differing less in this respect than they do in their cones, or in the length of their foliage. *P. Laricio* (which we consider as including a number of European and some Asiatic kinds, generally ranked as species, such as *P. taúrica*, *P. romána*, *P. calábrica*, *P. caramánica*, &c.) is distinguished by its long, sharply pointed, concave-sided, resinous buds; and *P. Pináster* and *P. Pínea*, by their short, blunt, imbricated buds, which are never covered with resin. The buds of *P. Tæda* (which we consider to be the centre of a group of varieties generally treated as species, under the names of *P. rígida*, *P. variábilis*, *P. serótina*, &c.) are very small and resinous, and they are more numerous on the shoots than in any other species, either European or American. All the kinds belonging to *P. Tæda* have also the peculiar property of sending out numerous small abortive shoots from the dormant or adventitious buds in their trunks and larger branches, by which the trees may be known at a glance, even at a distance. All the tender kinds (such as *P. longifolia*, and its allied sorts, *P. leiophylla*, *P. canariensis*, &c.) have small obscure buds; and so on. The scales of

the cones of all the varieties of *P. sylvestris* terminate in surfaces having more or less the appearance of a depressed pyramid; those of all the varieties of *P. Laricio* have a smooth lip, more or less protruding, and terminating in a depressed point; those of all the varieties of *P. Pinaster* terminate in a strong woody pyramidal point; and those of all the varieties of *P. Tæda* in a slender sharp prickle, turned upwards or downwards. The cones of different varieties of what we consider as the same species vary much in size; and, as these variously sized cones are generally reproduced from seed, the plants bearing them have been usually treated as distinct species. We do not, however, consider the fact of the seed of large-coned varieties producing plants bearing large cones, any more a proof that the kind is a species, than we do that of seedlings from the seeds of a large apple producing trees bearing large apples, a proof that the particular kind of apple is a species distinct from apple trees bearing small apples. The cones of *P. (s.) p. Mughus* are twice the size of those of *P. (s.) p. pumilio*; but in other respects the plants are hardly distinguishable. Perhaps we shall be told that the comparison between pine trees and apple trees is not a fair ground of argument; because the apple tree is in a state of culture, and far removed from its natural habits; but to this we answer, that the same effects as those produced by culture in the apple tree, are produced by a variety of geographical and physical circumstances in the pine tree; and of this the two above-named varieties of *P. sylvestris* may be cited as a proof.

The leaves of all the species of pines may be classed according to the number in a sheath; and this is a most convenient mode of determining the groups and even the species, in the case both of young plants, and of trees without cones. All the European species, with the exception of *P. Cembra*, have only 2 leaves in a sheath, and most of the Asiatic, Mexican, and Californian kinds have 3, 4, or 5 leaves; while those of the United States and Canada have, for the most part, 3. The leaves vary in length in different species; but much less so in the varieties of the same species than might be imagined. Thus, in all the varieties of *P. Laricio* the leaves are nearly double the length of those of *P. sylvestris*.

Pinus. In studying this genus, and arranging the kinds according to their buds, cones, and leaves, we consider *P. sylvestris*, *P. Laricio*, *P. Pinaster*, *P. Pinea*, *P. halepensis*, and *P. Cembra*, as the principle European species, and the other European kinds as only varieties of them. *P. australis*, *P. Tæda*, *P. Banksiana*, *P. inops*, *P. pungens*, and *P. Strobus*, we consider as the principal species of North America. *P. Sabiniana*, *P. ponderosa*, and *P. insignis* are the principal species of California. *P. Lambertiana* and *P. monticola* also from California, and *P. excelsa* from Nepal, appear to be only varieties of *P. Strobus*. The most remarkable species from Nepal is *P. Gerardiana*, which has straight stiff leaves like those of *P. Pinea*, but with caducous sheaths.

Abies is a genus of which there are so few species, that it is attended with no great difficulty. *A. rubra*, *A. nigra*, and *A. alba* are probably only different forms of one and the same species. *A. Smithiana* may possibly be a variety of *A. excelsa*, and *A. dumosa* of *A. canadensis*. *A. Douglasi* and *A. Menziesii* appear specifically distinct, but there are only very small plants of the latter in this country. One of the most remarkable species of *Abies*, from Cephalonia, which has lanceolate and sharp-pointed leaves, like those of an araucaria, has just (1837) been introduced.

Picea is a very easy genus; *P. balsamea*, *Fraseri*, and *Pichta* are probably only varieties of one species; and, though *P. Webbiana* has purple cones, we doubt whether it can be considered more distinct from *P. pectinata* than *Tilia grandifolia* is from *T. parvifolia*. The colour of the cones in the *Abietinæ* has no claim to be considered a specific distinction; because in all extensive woods of one species, such as of *P. sylvestris* and *Larix europæa* in Scotland, they will be found to vary considerably.

Larix. It appears very doubtful to us, whether there are more than one

species of this genus ; but the varieties we admit to be distinct ; and these might be increased in number, if the colour of the flowers and of the cones were taken into consideration.

To observe the different forms assumed by the same species, they should be studied in all their native habitats ; and, to mark how all these different forms return to that of the species which may be considered the central or normal form, it is necessary to study them under cultivation in the same soil, situation, and climate. Many species of *Abiétinæ* that are very distinct in the forests of America, come very near to each other in the pinetums of Britain ; and species which appear very distinct in the pure air and elevated situation of Dropmore, are hardly recognisable as different in the smoky atmosphere of the Hackney arboretum. It is very remarkable, that, in this last situation, the only species which thrive are *P. Laricio* and its varieties, and *P. Pinaster* and *P. Pinea*. These, therefore, may be considered the best pines for planting in cities.

Whatever we may think on the subject of species, we have treated all the kinds in such a manner, and given so many synonymes, that those who differ from us in opinion will find no difficulty in recognising in our pages the species of other authors. The great objects that we have had in view, in this work, in reducing the number of species, have been to simplify and to generalise, in order to render the subject of technical distinctions less perplexing to general readers, and to young students in arboriculture.

As the dried specimens of the *Abiétinæ*, from the large size of the cones, cannot, in general, be kept in paper, like the specimens of broad-leaved trees, we may mention, for the benefit of gardeners, that we have found slight paste-board boxes, like those in which hats are kept, which cost, in London, about 6d. each, a very convenient receptacle for enclosing them. Each box will contain, at an average, half a dozen species. The specimens, as soon as possible after being gathered, should be dipped in boiling water, in consequence of which they will retain their leaves ; and as the cones generally open by drying, when it is wished to see their correct shape, they ought to be put into cold water for a quarter of an hour, till the scales close up, and the cone resumes its original form.

GENUS I.



Pinus L. THE PINE. *Lin. Syst. Monœcia* Monadélphia.

Identification. *Lin. Gen.*, 408 ; *Juss.*, 414 ; *Fl. Br.*, 1081. ; *Tournef.*, t. 355, 356 ; *Gærtn.*, t. 81 ; *N. Du Ham.*, 5 p. 329 ; *Lamb. Pin.*, 2d ed., 1 t. 1.

Synonymes. *Le pin*, Fr. ; *Fichte*, *Fynbaum*, or *Kiefer*, *Ger.* ; *Fynboom*, *Dutch* ; *Pino*, *Ital.* and *Span.* ; *Pinu*, *Anglo-Saxons* ; *Pinnua*, *Welsh* ; *Peigne*, *Erse*.

Derivation. The word *Pinus* comes from the Greek *pinos*, used by Theophrastus to designate the pine tree. *Pinos* has for its root *pion*, which signifies fat ; because the trees of this genus furnish pitch and tar. Others derive the word *Pinus* from *pin*, or *pyra*, a mountain or rock, *Celtic* ; in allusion to the habitat of the tree ; the British towns *Fen-ryu*, *Fen-rith*, and *Fen-maen* ; and the Spanish ones, *Fenna-flor*, *Fenna-fel*, &c., being so call from being built on hills, or rocks.

Description. Evergreen trees, generally of large size, natives of Europe, Asia, and America, and in an eminent degree both useful and ornamental. They flower, in Britain, in May and June, and generally ripen their cones in the autumn of the following year. The species may be arranged either according to their cones, or their leaves ; and we have adopted the latter feature as the foundation of our sections, because it is applicable to trees in every stage of their growth ; and because many of the species in London gardens have not yet borne cones.

Sect. i. *Binæ*.—Leaves generally 2 in a Sheath.

§ i. *Sylvéstres*.

Sect. Char. Leaves short, more or less glaucous ; cones short, generally small,

on short footstalks. Buds ovate, blunt-pointed, and more or less covered with resin.

A. Cones having the Scales without Prickles.

‡ 1. *P. SYLVESTRIS* L. The wood, or Scotch, Pine, or Scotch Fir.

Identification. Lin. Sp. Pl., 1418.; Willd. 4. 494.; Ger. Emac., 1356.; Hook. Scot., 275.; Dum. Bot. Cult., 6. p. 456.; Woodv. Med. Bot., 370. t. 207.; Smith Fl. Br., t. 1031.; Huds. Angl., 423.; With. Arr., ed. 3. 615.; Pall. Ross., 1. p. 1. 5.; Vill. Dauph., 3. p. 804.; Mill. Illust., t. 82.; Du Roi Harbk., ed. Patt., 2. p. 16.; Hunt. Evel. Syl., 1. p. 274.; Eng. Fl., 4. p. 159.; Willd. Baum., p. 265.; Hayne Dend., p. 172.; Jaume St. Hilaire, t. 55.; Rich. sur les Conif., p. 55.; Hoss Anleit., p. 3.; Smith in Rees's Cycl., No. 1.; Hook. Br., p. 406.; N. Du Ham., 5. p. 230.; Lamb. Pin., ed. 1. t. 1., and ed. 8vo. 1. t. 1.; Michx. N. Amer. Syl., 3. p. 125.; Mackay Fl. Hibern., p. 258.; Lindl. Synop., p. 241.; Fouchet Bot. appliquée, 2. p. 666.; Laws Man., p. 323.

Synonymes. *P. folis binis*, Sc., *Hort. Hols.*, No. 1661.; *P. rubra* Mill. Dict., No. 3.; *P. sylvestris communis* Dit. *Hort. Kew.*, 3. p. 368.; *P.*, No. 22. *Gmel. Sib.*, 1. p. 178.; *Pin Sauvage*, *Pin d'Ecosse*, Fr.; *gemeine Föhre*, *gemeine Fichte*, *Kiefer*, *Taune*, and 55 other names, which are given in *Hayne's Abbildung*, *Ger.*; *Pynboom*, *Dutch*; *Pino sylvatico*, *Ital.*; *Pino sylvestre*, *Span.*; *Fyrre*, *Den. and Swed.*; *Sosna*, *Pol.*, *Bok.*, and *Russ.*

Eraserings. Woodv. Med. Bot., t. 207.; Pall. Ross., t. 2. f. 1.; Mill. Illust., t. 82.; Hunt. Evel. Syl., p. 274.; Black., t. 190.; Eng. Bot., 35. t. 2460.; Lamb. Pin., 2d ed., 1. t. 1.; N. Du Ham., 5. t. 66.; Michx. N. Amer. Syl., 3. t. 138.; Hayne Abbild., t. 153.

Spec. Char., &c. Leaves rigid, in pairs. Young cones stalked, recurved. Crest of the anthers very small. (*Smith.*) Buds (*fig. 2043.*) ovate, blunt-pointed, from $\frac{1}{2}$ in. to $\frac{1}{4}$ in. long, and $\frac{1}{2}$ in. wide in the broadest part; white, with a reddish tip, the white produced by resinous exudation. The central bud generally with 5 or 6 smaller ones round it. Leaves (*fig. 2044. b.*) from $1\frac{1}{2}$ in. to $2\frac{1}{2}$ in. long, somewhat wavy and twisted, slightly concave on the upper, and convex on the under surface; light bluish green, finely serrulated on the edges; the sheath lacerated and slightly ringed. Cones (*fig. 2044. a.*) from 2 in. to 3 in. long, and from 1 in. to $1\frac{1}{2}$ in. broad. Scales (*fig. 2044. d.*) from 1 in. to $1\frac{1}{2}$ in. long, terminating in an irregular four-sided projecting point, often recurved. Seeds, with the wing (*c.*), from 1 in. to $1\frac{1}{2}$ in. long; without the wing, from $\frac{1}{8}$ in. to $\frac{1}{4}$ in. long; dark-coloured. Cotyledons (*fig. 2045.*) 5 to 7. — A tall, straight, hardy, long-lived tree, from 60 ft. to 100 ft. high; a native of most parts of Europe, flowering in May and June, and ripening its cones about 18 months afterwards; the most valuable, for its timber, of all the European species of *Pinus*.

Varieties. Like all trees which have an extensive geographical range, and grow on almost every kind of soil, and at great elevations: as well as in plains, the varieties and variations of the Scotch pine are exceedingly numerous; both as respects the exterior appearance of the tree, and the quality of its timber and resinous products. On poor soils, at great elevations, it becomes a diminutive shrub: and in low situations, where it is a lofty timber tree, the wood on some light sandy soils, is white, almost without resin, and of little duration; while on other soils, of a colder and more substantial nature, it is red, heavy, and of great durability. It appears, also, that the same soil will produce both white-wooded, and red-



2043

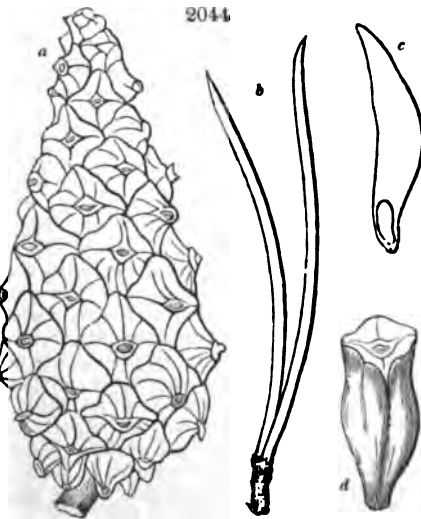

2044

wooded trees; and that seeds from red-wooded trees will, at least in many instances, produce others the wood of which is red. The first recorded notice which we have of varieties or variations in the quality of the timber of the Scotch pine is in the *Treatise on Forest Trees*, published by the Earl of Haddington in 1760. His Lordship says: "Though I have heard it asserted that there is but one kind of Scots fir, and what difference is seen in the wood when wrought is only owing to the age of the tree, and the soil where it grew, yet I am convinced it is otherwise; for this reason: When I cut firs that were too near the house, there were people alive here who remembered when my father bought the seed. It was all sown together in the seed bed, removed to a nursery, and afterwards planted out the same day. These trees I cut down, and saw some of them very white and spongy, others of them red and hard, though standing within a few yards of one another. This makes me gather my cones from the trees that have the reddest wood, as I have said before." (*Treatise, &c.*)

Boutcher, in 1775, says that it has been an old dispute, which still subsists, whether there are more sorts than one of the Scotch pine or fir. It is commonly objected, he adds, that the difference which we see in the wood is owing to the age of the tree, or the quality of the soil in which it grows; but that this opinion is founded on insufficient observation, for he has seen many pine trees cut down of equal age, in the same spot, where some were white and spongy, and others red and hard. "The difference of colour may easily be distinguished by any one who walks through a newly pruned plantation even of young trees." (*Treatise, &c.*, p. 137.) The important fact, that both red and white wood may be produced by the same soil, is confirmed by two specimens of wood in Lawson's Museum, Edinburgh. They were presented by James Farquharson, Esq., of Invercauld, in Inverness-shire, the proprietor of some of the finest native forests of Scotch pine in Scotland. One of the specimens was of very fine-grained red wood, cut from a tree 200 years old, and grown on a gravelly soil with a mixture of clay; and the other was a specimen of a white-wooded tree, cut from one about 70 years of age, which had been grown on the same soil. (*Man.* p. 332.)

The difference, both in the external appearance and in the qualities of the timber of different trees of *Pinus sylvestris*, received a good deal of attention from Mr. Don of Forfar, about 1810 (see *Mem. Cal. Hort. Soc.*, vol. i. p. 121.); and, subsequently, from various other authors, more especially the cultivators of the pine and fir tribe in France: but, after all that has been done on the subject, we agree with M. Vilmorin, who has studied *P. sylvestris*, in its various forms, more, we believe, than any other man, that its varieties can only be properly known and described by those who have studied them in collections, or *écoles d'étude*, in which several plants of each sort have been planted in the same ground, and allowed to attain maturity there, both standing singly, and in masses. (Delamarre's *Traité Pratique de la Culture des Pins, &c.*, p. 24.: note by M. Vilmorin.) M. Vilmorin, as we have already mentioned (p. 2121.), has made a collection, for this purpose, of all the varieties of the Scotch pine that he could procure in Europe, on his estate at Barres, near Montargis; with the view, after a suitable period, of determining the distinct sorts. In the present state of uncertainty on this subject, we shall confine ourselves to giving the names of a few of the more marked varieties, of which we have seen plants in the environs of London.

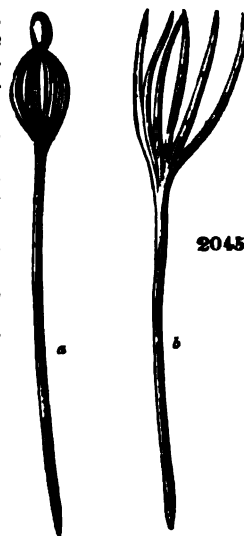

a. *Timber Trees.*

‡ *P. s. 1 vulgaris*, the common wild Pine (fig. 2046., to our usual scale), is thus described by Don of Forfar. Branches forming a pyramidal head; leaves marginated, of a dark green colour, and but little glaucous underneath; cones considerably elongated, and tapering to a point, and the bark of the trunk very rugged. "This variety seems to be but short-lived, becoming soon stunted in its appearance, and it is altogether a very inferior tree to either variety 2, or variety 3." (*Cal. Mem.*, i. p. 123.) The common wild pine of the French is, by Loiseleur Deslongchamps and some other authors, called simply *P. sylvestris*, while others again name it *P. s. genevensis*: but, whether the *P. sylvestris* of Loiseleur Deslongchamps (in the *Nouveau Du Hamel*) and of Bosc, and the *P. s. genevensis* of Delamarre (*Traité Prat.*, &c., p. 23.) and of several other French authors, apply to one and the same variety; and whether this variety be identical with the *P. s. genevensis* of the Horticultural Society's Garden, received from Noisette of Paris, and of which a plate is given in our last Volume; we are unable to decide. If they are the same, which we think very likely to be the case, then the *P. sylvestris* of the French is of little value as a timber tree, and very inferior to even the *P. s. vulgaris*, or commonest variety of the Scotch pine found in Britain.



2046

‡ *P. s. 2 horizontalis*; *P. horizontalis* Don of Forfar; *P. sylvestris* var. *montana* Sang, *Plant. Cal.*, p. 65.; the Speyside Pine, *Hort. Soc.*; the Highland Pine, *Grigor* in *Gard. Mag.*, viii. p. 10.; the horizontal-branched wild Pine, *Laws.*; the red-wooded Scotch Pine, *Sang*; ? *P. rubra* *Mill. Dict.* and *N. Du Ham.* — This variety is described by Don of Forfar as being "strongly marked and permanent." It "is distinguished from the former by the disposition of its branches, which are remarkable for their horizontal direction, and for a tendency to bend downwards close by the trunk. The leaves are broader than those of the first variety, and serrulated, and not marginated. They are distinguishable at a distance by their much lighter and beautiful glaucous colour. The bark of the trunk is not so rugged as in the preceding variety. Its cones are thicker, not so much pointed, and smoother. The tree seems to be a more hardy plant, being easily reconciled to very various soils and situations. It grows very freely, and quickly arrives at a considerable size." Mr. Don also conjectures "that the fir woods which formerly abounded in Scotland, the trees of which arrived at a large size, may have been of this variety or species." "I have certainly observed," he adds, "that the greater part of the fir woods of the present day, which are so much complained of, are of the common variety [*P. s. 1 vulgaris*]; at least, not more than one tree out of 10 or 12 is of the second and more desirable kind [*P. s. 2 horizontalis*]. I think," continues Mr. Don, "that this is the most natural way of accounting for the supposed decline of the Scotch fir in this country, for two reasons: 1st, because var. 2 [*P. s. 2 horizontalis*] retains all the good qualities formerly attributed to the Scotch fir; and, 2dly, because, as var. 1 [*P. s. 1 vulgaris*] produces its cones much more freely than the other, the seed-gatherers, who are paid by the quantity, and not by the quality, would seize upon the former, and neglect the latter."

(*Cal. Mem.*, i. p. 125.) This variety abounds in the counties of Aberdeen, Moray, and Inverness, more especially in the Highland districts of Abernethy and Strathspey; and in the forests of Mar, Invercauld, and Glentanner, along with the white-wooded pine, and always on a light hazelly loam. The first individuals who collected seeds and raised plants for sale of this variety were Messrs. A. and J. Grigor, nurserymen at Elgin and Torres; for whose exertions the Highland Society awarded them a premium in 1830. This variety appears to be that alluded to by Sir Walter Scott in the *Quarterly Review* for October 1828, in which he recommends procuring the seeds of red pine from the Highlands of Scotland, alleging that the ordinary, or white-wooded, "Scotch fir" is "an inferior variety, brought from Canada not more than half a century since." This Canadian variety he describes "as a mean-looking tree, but very prolific of seed; on which account the nursery gardeners are enabled to raise it in vast quantities." (See *Gard. Mag.*, vol. iii. p. 351.) Every botanist knows that the Scotch pine is not indigenous to America; and every nurseryman, that seeds of pines of any kind are received from that country only in very small quantities. It is certain, however, that the commonest description of Scotch pine is much more prolific of seed than the *P. s. horizontalis*; and this circumstance may have led Sir Walter Scott into the above-mentioned error. We may also add that at Stratton Strawles, in the neighbourhood of Norwich, there are two kinds of pines in the woods of Robert Marsham, Esq., of both of which that gentleman has sent us specimens. One of them is called the Scotch pine, and the other the American pine; but both are obviously *P. sylvestris*: the so called American variety has longer leaves and a redder bark than the other; and, when cut down, the wood is found white throughout, while the heart wood of the other is red. There are young plants of *P. s. horizontalis* in the Horticultural Society's Garden; and both plants and seeds of it may be obtained in large quantities from Messrs. Grigor of Elgin and Forres, Mr. Lawson of Edinburgh, Mr. Chariwood of London, and M. Vilmorin of Paris. There is a tree at Syon, which, in 1837, was named *P. rubra*, and which answers to the description of Don's variety. It is 25 ft. high, and was planted about 1825. The branches are depressed towards the stem; and the leaves are short, and of a beautiful glaucous hue.

- ‡ *P. s. 3 uncinata*, the hooked-coned wild Pine; Mar Forest wild Pine, *Hort. Soc. Garden*; is another of Don of Forfar's varieties, which is described by him, in the article before quoted, as a remarkable variety, quite distinct both from *P. s. vulgaris* and *P. s. horizontalis*. Its leaves are of a still lighter colour than those of the last, insomuch that they appear of a truly light glaucous hue, approaching to a silvery tint. Its branches form, like *P. s. vulgaris*, a pyramidal head; but it differs remarkably in its cones from both the former varieties; the cones in this variety having the appearance of being beset with blunt prickles bent backwards. The leaves are serrulated; a character which at once distinguishes it from *P. s. vulgaris*, with which the tree agrees in having a pyramidal head. This variety is more common than *P. s. horizontalis*, and it also produces good timber. There are young plants of this variety in the Horticultural Society's Garden, and it may be obtained, also, of Mr. Lawson, Edinburgh. *Fig. 2047.* is a cone of the *P. s. uncinata* of M. Vilmorin, taken from a cone received from that gentleman, and which we conclude to be the same variety as, or at all events nearly related to, that described by Don of Forfar. It will be observed that this hooked cone is quite different, both in its general form, and the

form of its scales, from the cone of *P. (s.) p. Müghus*, which is also often called *P. uncinata*.

‡ *P. s. 4 hagenensis*; Pin de Haguenau, *Fr.*; Rothentanne of Schöttel, seedsman, Rastadt.

This variety was introduced from the forests of Haguenau (whence its name) and Rastadt, on both sides of the Rhine. It is thus described in Lawson's *Manual*:—"The old trees are remarkably tall, straight, free from branches, except near the summit, with remarkably smooth reddish-coloured bark. The leaves of the young plants are longer than those of any of the preceding varieties; they are much waved or twisted, of a light green slightly glaucous colour, and minutely serrulated; the young terminal buds are of a peculiar reddish colour, and generally more or less covered with whitish resin. The young plants are, besides their difference in shade of colour, readily distinguished by their stronger and more rapid growth." (*Agricult. Manual*, p. 230.) On December 2. 1828, we inspected the trees of this variety growing in the neighbourhood of Rastadt, and purchased some seeds; and on the next day we went through the Forest of Haguenau, in company with M. Nebel, of the firm of Nebel and Neunreutter, dealers in madder and in seeds of the Haguenau pine. The young trees on both sides of the Rhine were of remarkably vigorous growth, and answer well to the description of the variety given by Mr. Lawson. The soil in which they were growing on the German side of the Rhine was gravelly or sandy on the surface, and somewhat loamy below; that at Haguenau seemed to be all a deep sand; but, the surfaces of both forests being quite flat, and very little above the level of the Rhine, there can be no doubt of the subsoil, at a certain depth, being moist in both cases. The Forest of Haguenau, M. Nebel informed us, extended over upwards of 30,000 acres; but the greater part of the pine trees were cut down during the war. There were still, however, a number remaining, with trunks remarkable for the red colour and scaly (not furrowed) appearance of the bark, from 2 ft. to 3 ft. in diameter, and from 60 ft. to 80 ft. or 90 ft. high. The seed is taken out of the cones by drying on the same kiln which is used for drying madder; and was sold, in 1828, at 1 franc 15 sous a pound. We brought over some and distributed it; and there are young trees in Perthshire, in two places, to which the planters have given the names of Loudon's Howe and Loudon's Brae. (See *Gard. Mag.*, vol. v. p. 663.) Seeds of this variety may be obtained from Vilmorin, Charlwood, and Lawson; and from the latter, we believe, also young plants.

‡ *P. s. 5 rigensis*; Pin de Riga *Desf. Hist.*, t. ii. p. 61.; Pin de Russie, Pin de Mâture, *Fr.*—This variety is said to constitute the forests of Lithuania and Livonia; to which, according to Desfontaines, the minister of marine of the French government, in 1785, sent a master mast-maker, named Barbé, from Brest, who brought back with him a great quantity of seeds. These were sown at Koual, near Brest; at Couatilloux, near Annion; at Mency, in the vicinity of Odierno; and on the grounds of Du Hamel at Monceau. According to M. Fougereux, the plants which came up did not differ from the *P. sylvêstris*; and he adds that Miller, in a letter to Du Hamel, thanking him for the seeds of the pin de Riga which he had sent, states that he had previously received 50 lb. of the seed of the Riga



pine from the Duke of Northumberland, and that the trees produced were exactly similar to the Scotch pine. Pallas assures us that the pine of Livonia and Lithuania differs not from the *P. sylvestris*: masts, he says, are not made of any peculiar species, as foreigners, and more especially the French, think; but they are all of the *P. sylvestris*. Those trees are chosen that have a yellow bark, and a tall straight trunk, free from branches. (*Desf. Hist. des Arb.*, ii. p. 619.) In 1814, this variety was again brought into notice by the late Professor Thouin, who published a tract on the subject, recommending its culture, on account of the superiority of its wood to that of the common French variety of *P. sylvestris*. M. Puvis (*De l'Agric. du Gatinais, &c.*) describes the pin de Riga as growing beside the pin de Haguenau, on M. Vilmorin's estate at Barres, and rivalling that variety in dimensions. The following are Mr. Lawson's remarks on this variety:—"From the superior quality of the timber of *P. sylvestris* imported from Riga under the name of red pine, to distinguish it from that of *Abies communis*, or white deal, it has been considered advisable to procure seeds from the natural forests in the neighbourhood of that place, and to the plants produced from such seeds the above name is applied. They may at least be considered as possessed of equal merits with such as are derived from the best native forests in the Highlands of Scotland." (*Agric. Manual*, p. 331.) Seeds and plants of this variety may be obtained of Mr. Lawson and M. Vilmorin; and there are specimen plants of it in the Horticultural Society's Garden, in the arboretum at Kew, and at Messrs. Loddiges.

Other Timber Tree Varieties. The names of several might be given from books; but, as we could neither accompany them by descriptions or synonymes, nor refer to any place where living plants may be seen, we consider that it would be of very little use. *P. s. altissima*, in the Horticultural Society's Garden, is a strong-growing variety, resembling the pin de Haguenau, and is probably identical with it, though raised from Caucasian seeds; but *P. altissima* is a name more generally applied to *P. Laricio* than to *P. sylvestris*.

b. *Varieties curious or ornamental.*

- 2 *P. s. 6 genevensis.* *The Geneva wild Pine.*—There is a plant of this variety in the Horticultural Society's Garden, a portrait of which is given in our last Volume, by which it appears to be a low crooked tree, with numerous twisted branches, extending considerably at the base. There is a good specimen at Dropmore. We have already suggested that this may possibly be the commonest and most worthless variety of *P. sylvestris* which attains a timber-like size in France. (See p. 2155.)
- 3 *P. s. 7 monophylla* Hodgins. — The leaves are long and glaucous, and those of each sheath are generally attached to each other throughout their length; though when the points are taken between the finger and thumb, and the apparently single leaf twisted, it generally separates into two, and sometimes into three leaves. We have only seen one plant in the Horticultural Society's Garden, to which it was sent by Mr. Hodgins, nurseryman, Dunganstown, near Wicklow, about 1830.
- 4 *P. s. 8 scariosa*; *P. scariosa* Lodd. *Cat.*, ed. 1836. — A French variety, introduced about 1820; but the plant at Messrs. Loddiges's is small, and scarcely appears different from the species.
- 5 *P. s. 9 intermedia.*—This is a Russian variety, of which there is a plant in the Horticultural Society's Garden, having slender young shoots depressed towards the stem, and leaves shorter and less glaucous than those of the species.

- ‡ *P. s. 10 altica* Ledebour.—A plant in the Horticultural Society's Garden, raised from seeds received from Dr. Ledebour in 1836, and which is only between 3 in. and 4 in. high.
- ‡ *P. s. 11 tortuosa* Don of Forfar.—This variety Mr. Don describes as having the leaves shorter than *P. s. vulgaris*, and somewhat curled, or, rather, twisted. He only saw three or four trees of it, and thinks it nearly approaches the *P. Banksiana* of Lambert.

Other Varieties of curious or botanical Interest. Several names might be added from books; but, as we have not seen the plants, or seen them only in a very young state, we do not think them worth notice. We might have included in the list, *P. (s.) pumilio*, and its subvariety *P. (s.) p. Mughus*; but though we have no doubt of their being only varieties of *P. sylvestris*, yet they are so very different both in appearance and magnitude, that we think them well worth keeping distinct.

Description. The wild, or Scotch, pine, in favourable situations, attains the height of from 80 ft. to 100 ft., with a trunk from 2 ft. to 4 ft. in diameter, and a head somewhat conical or rounded, but, as compared with the heads of broad-leaved trees, generally narrow in proportion to its height. The bark is of a reddish tinge, comparatively smooth, scaling off in some varieties, and rough and furrowed in others. The trunk, when the tree stands singly, is generally furnished with branches from within a short distance of the ground to the summit; nevertheless, in this, as in all the species of the pine and fir tribe, the lower branches have a greater tendency to decay and fall off than in broad-leaved trees. In like manner, when the trees are grown in masses, the branches die off sooner, and so much so, that no European broad-leaved tree, of equal girth of trunk, is found clear of branches to so great a height as the wild pine. The branches are disposed in whorls from 2 to 4 together, and sometimes 5 or 6: they are at first slightly turned upwards, but, as the tree advances, in growth they take a horizontal tendency, and finally become somewhat pendent, with the exception of those branches which form the summit of the tree. The leaves are in sheaths, spirally disposed on the branches; they are distinguishable at first sight from those of all other pines in which the leaves are in pairs, by being much more glaucous, more especially when in a young state, and straighter. Those of *P. Banksiana* and *P. inops* are also rather glaucous when young, but they are much shorter and more twisted. Those of *P. Laricio* and *P. resinosa* can never be mistaken for those of *P. sylvestris*, from not being glaucous, and from their much greater length; nor those of the section *Tæda* from their being 3 in a sheath. Examined more minutely, the leaves of *P. sylvestris* will be found to have their two interior surfaces (which, while they are in the sheath, face each other) quite flat, or nearly concave, so as to form before they expand, or when they are pressed together, a cylinder of about half a line in diameter. The general length of the leaves, in vigorous-growing trees under 20 or 25 years' growth, is from 2 in. to 3 in.; but in old trees they are much shorter: they are smooth on both surfaces, stiff, obtuse at the extremities, with a small point, and minutely serrated; dark green on the upper (that is, the flat or concave) side, and glaucous and striated on the under side, which is convex. They remain green on the tree during four years, and generally drop off at the commencement of the fifth year. Long before this time, and generally at the beginning of the second year, they have entirely lost their light glaucous hue, and have become of the dark sombre appearance which is characteristic of this tree at every season except that of summer, when the young glaucous shoots of the year give it a lighter hue. The flowers appear commonly from the middle of May till the middle of June. The male catkins are from $\frac{1}{2}$ in. to 1 in. or more in length; and they are placed in a whorl or whorls at the extremities of the branches of the preceding year, and round the base of the young shoots of the current year. The flowers are composed of two or more stamens; each stamen being surmounted by two anthers of a sulphur colour. The anthers contain a considerable quantity of yellow powder, which,

when they burst, is sometimes dispersed in such immense quantities as to fill the air, and give rise, as we have already observed (p. 2109.), to the idea of a shower of sulphur. The female flowers, or embryo cones, appear on the summits of the shoots of the current year, generally 2 on the point of a shoot, but sometimes 4, 5, or 6. The colour of these embryo cones is generally purple and green; but they are sometimes yellowish and sometimes red. After impregnation, the young fruit becomes lateral, stalked, and reflexed; green, and of a more ovate figure. The first year, it ceases to grow about the middle of July, when it has attained the size of a good bean; and in the second year it begins to grow in the month of April, attains its full size by the end of June, and ripens into an ovate, pointed, hard, tessellated, but unarmed, woody cone, about the middle of October. If left on the tree, it is not till the following March or April that the scales open, and allow the seeds to drop out. It thus requires 18 months to mature the cones; and in a state of nature it is two years before the seeds are in a condition to germinate. After the seeds have dropped out, the cones generally remain on a year, or at least till the following winter; so that full-grown trees generally exhibit cones in three or four different states; viz. young cones in their first stage; cones of full size, but green; cones brown and opening; and cones with their scales fully expanded, after the seeds have dropped. The cone, which is stalked, and when mature begins to open at the narrow extremity, as shown in *fig. 2048.*, is, while closed, perfectly conical, rounded at the base, from $1\frac{1}{2}$ in. to 2 in. in length, and about an inch across in the broadest part; as it ripens, the colour changes from green to a reddish brown. The scales are oblong, swelled on their back part of their upper extremity into a sort of pyramid, which appears pressed down upon itself, and is truncate at the summit. The form of this swelled part of the scales is very variable. Sometimes it does not project at all, and the surface of the cone is quite smooth; and, in general, it projects much less on the side of the cones which is next the branches, than on that which is exposed to the air. Sometimes the pyramid in which the scale terminates is raised so as to form a protuberance of more than two lines in height. Sometimes the summit of the pyramid is sunk; and sometimes it is pointed, and turned to one side; while at others, as in *P. (s.) p. Mughus*, it is turned downwards towards the base of the cone, and terminates in a prickle. This variation in the form of the scales of the cone of *P. sylvestris* has given rise to different varieties; though hooked cones and smooth cones may frequently be found on trees having very different habits, such as *P. (s.) p. Mughus* and *P. s. uncinata*. At the base of each scale, on the inner side, close to the axis of the cone, are lodged 2 oval winged seeds, somewhat flattened. Each seed is a little monospermous nut, to which, as in all the other *Abiétinæ*, the wing is not attached, otherwise than by enclosing it with its membranaceous texture. Hence, the wings of the seeds of this pine, like those of every other species of *Abiétinæ*, may be separated from them without doing them the slightest injury. Sometimes the cones are sterile; but in this case the winged membrane is as fully developed as if it were fertile, which clearly proves that it does not form a part of the seed. In germination, the first appearance of the seed exhibits 5 or 6 linear leaves escaping from their envelope, as shown in *fig. 2045. a*; and in a few days afterwards, when the envelope has dropped, they assume the appearance of *b*. It is remarkable, that this species, which has the leaves of trees of 3 ft. or 4 ft. in height glaucous when young, has the seminal leaves, and the leaves of young plants in the first or second year, and sometimes even for 3 or 4 years, not glaucous; whereas in *P. Pinaster*, *P. Pinea*, and some others, the leaves of which, in

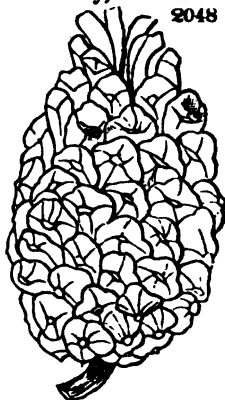

plants of 4 or 5 years' growth, are not glaucous, the seminal leaves, and the leaves of young plants of 2 or 3 years' growth, are entirely so. The seeds of the Scotch pine come up in about 3 or 4 weeks after they are sown : the growth is not above 3 in. or 4 in. the first year ; the second, if on a good soil, they will grow from 4 in. to 6 in. ; and the third year the plants begin to branch, and attain the height of from 14 in. to 2 ft., according to soil and situation. In the fourth and fifth years, if not transplanted, or if they have been transplanted carefully in the second year, they begin to push strongly, making a leading shoot from 1 ft. to 3 ft. in length, according to soil and situation ; and they continue growing vigorously for half a century, or even a century, according to circumstances. In 10 years, in the climate of London, plants will attain the height of 20 ft. or 25 ft. ; and in 20 years, from 40 ft. to 50 ft. Evelyn mentions a Scotch pine which grew 60 ft. in height in little more than 20 years. Like almost all the other species of the *Abiétinæ*, the Scotch pine is a social tree, and is always found in masses of considerable extent. The tree is considered full grown, and fit to be cut down for timber, at 50 or 60 years' growth ; but where it grows slowly, as in its native habitats in the north of Scotland and other cold climates, it will continue increasing for three or four centuries. Mr. Farquharson of Marlee, in the Highlands of Scotland, Mr. Strutt informs us, cut over close to the root a tree of 2½ ft. in diameter, which is nearly the size which a Scotch pine, reared in a nursery, and then planted out, would attain in about 50 years ; and he counted exactly 214 circles, which made this self-sown tree about four times the age of the cultivated one. In Sweden, Dr. Walker informs us, 360 circles have been numbered in a tree that was composed entirely of sound wood. The largest Scotch pine that was ever cut down in Scotland is supposed to be one which stood in the Forest of Glenmore, which was called the Lady of the Glen, and of which there is a plank in the entrance hall of Gordon Castle, 6 ft. 2 in. long, and 5 ft. 5 in. broad. The annual layers of wood, as reckoned by Mr. Grigor (see *Highland Soc. Trans.*, xii. p. 128.), are about 235. The plank bears the following inscription on a brass plate :—

“ In the year 1783,

WILLIAM OSBOURNE, Esquire,

Merchant of Hull, purchased of the Duke of Gordon the Forest of Glenmore, the whole of which he cut down in the space of twenty-two years, and built, during that time, at the mouth of the river Spey, where never vessel was built before, forty-seven sail of ships of upwards of 19,000 tons burthen. The largest of them of 1050 tons, and three others, little inferior in size, are now in the service of His Majesty and the Honourable East India Company. This undertaking was completed at the expense (of labour only) of above 70,000*l.* To His Grace the Duke of Gordon this plank is offered, as a specimen of the growth of one of the trees in the above forest, by His Grace's most obedient Servant,

Hull, September 26, 1836.

WILLIAM OSBOURNE.”

The Scotch pine which is supposed now to contain the most timber of any tree of the species about Gordon Castle is one of which the skeleton portrait, *fig.* 2049., was kindly sent to us by the Duke of Richmond. It is about 100 ft. high, and contains 260 cubic feet of timber, exclusive of the branches. Some of the finest single specimens of Scotch pine in the neighbourhood of London are at Whitton and Pain's Hill, where some of them are between 80 ft. and 90 ft. high, and, standing singly, are very picturesque in their general forms. A portrait of one of the handsomest of those at Pain's Hill, by H. Le Jeune, Esq., is given in our last Volume. There are also a few very fine specimens at Muswell Hill, a portrait of one of the most picturesque of which, by W. A. Nesfield, Esq., is given in our last Volume. There are others at Studley, in Yorkshire, of one of which, 82 ft. high, *fig.* 2050., to a scale of 24 ft. to 1 in., is a portrait by H. W. Jukes, Esq. ; and there is a very

noble specimen at Dunmore, which is considered to be the most picturesque tree in the Lowlands of Scotland, and of which *fig. 2051.* is a portrait after Strutt, to a scale of 24 ft. to 1 in. The height of this tree was, in 1836, 67 ft.; and the diameter of the trunk, at 1 ft. from the ground, 3 ft. 9 in.; and it was estimated to contain nearly 300 ft. of timber. Among the finest specimens in the Highlands of Scotland are those in Strathspay, of a group of which *fig. 2052.*, to a scale of 24 ft. to 1 in., is a portrait by W. A. Nesfield, Esq. The tallest of these trees is 75 ft. high.

The quality of the timber of the Scotch pine, according to some, is altogether dependent on soil, climate, and slowness of growth; but, according to others, it depends jointly on these circumstances, and on the kind of variety cultivated; and this is our opinion. It is acknowledged, that the timber of the Scotch pine, grown on rocky surfaces, or where the soil is dry, sandy, or hazelly, is, in general, more resinous, and redder in colour, than that of such as is grown on soils of a clayey nature, boggy, or on chalk: but this is not always the case; for an instance is given, in Lawson's *Manual*, of "a plantation, recently cut down, which stood on the north side of the Perth and Dundee road, nearly 10 miles from the former, the seed of which was, 70 or 80 years since, received from the Forest of Mar; and the timber, although grown on a poor, damp, tenacious clay, besides attaining to a great size, was found equal in quality to that for which the above natural forest is esteemed." (*Ag. Man.* p. 320., note.) Scotch "pine timber," Sir T. D. Lauder observes, "is best in the colder situations. In the warmer regions, it contains a great deal of white, or sap,

wood. At what time the sap wood is transformed into durable, or red, wood, has not yet been determined by vegetable physiologists; and, though most writers believe that the ligneous matter is deposited in the second year, we are disposed to doubt the fact. More than a dozen layers of sap wood may be counted on some trees; and, what is a very interesting observation, where trees have been much exposed to the mid-day sun, the whole southern half of the tree is sometimes found to be little better than sap wood, whilst the northern half may contain only a layer or two of it at the circumference." (*Laud. Gilp.*, i. p. 174.)

The durability of the red timber of the Scotch pine was supposed, by the celebrated engineer, Brindley, to be as great as that of the oak; and Dr. Smith, in his *Essay on the Production of Timber*, in the *Transactions of the Highland Society of Scotland*, vol. i. p. 165., says that he has seen some Scotch pine grown in the North Highlands, which, when taken down after it had been 300 years in the roof of an old castle, was as fresh and full of resin as newly imported timber from Memel; and that part of it was actually wrought up into new furniture.

Geography. *P. sylvestris* and its varieties are indigenous throughout the greater part of Europe, from the Mediterranean on the south, to 70° N. lat.

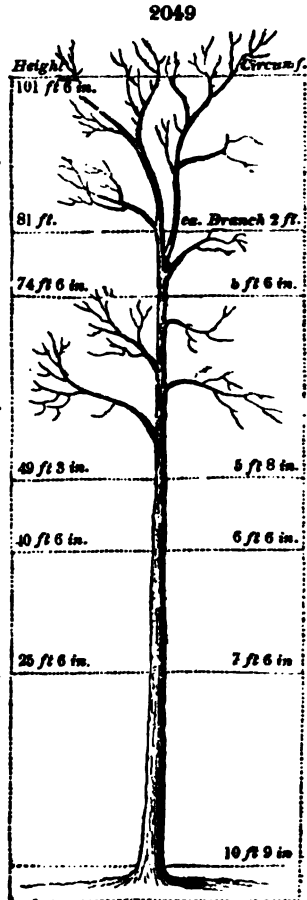

in Norway on the north; and from Spain and Britain on the west, to the confines of Siberia and Kamtschatka on the east. It extends into the north, east, and west of Asia; and, according to some, it is found at Nootka Sound, in North America. In the south of Europe, it grows at the elevation of 1000 ft. to 1500 ft.; in the Highlands of Scotland, at 1400 ft.; and in Norway and Lapland, at 700 ft. In the extreme elevations, as in the extreme limits of its northern range, it assumes the character of a stunted tree, or bush. Mirbel indicates the range of the Scotch pine to be, "Caucasus, Peloponnesus, Calabria, Valencia, Pyrenees, Lapland to 70° N. lat., Bucharia; Western Siberia, on the Oby, under 64°, perhaps beyond; Eastern Siberia, at the Stananoi Mountains, in 62° or 63°; Kamtschatka, between 55° and 57°; Dahuria, Japan." The elevation to which it attains on the mountains, according to the same author, is, in Lapland, under 70°, to 125 toises (of about 6 ft. 6 in. each); on the Carpathians, to 500; on the Alps of Switzerland and Dauphiné, to 870; on the Pyrenees, from 600 to 1250; and on the Caucasus, to 900 toises (or 3850 ft.) Von Buch considers the space between *P. sylvestris* and perpetual snow in Norway to be 2771 ft.; and that the mean temperature where it ceases is 31° of Fahrenheit. Wahlenberg makes the mean temperature of the earth 1° 8' Cel. (ab ou 35° Fahrenheit), and the elevation 1278 ft., where it ceases in Swedish Lapland." (*Watson's Outlines, &c.*, p. 269.) The Scotch pine is most abundant in the north of Europe, between latitude 52° and 65°. There are immense forests of it, on even ground, in Poland and Russia, and on hills and mountains in Sweden, Norway, Germany, the Alps, the Pyrenees,





and the Vosges. In Spain it is found, but not in great abundance; except in the form of the *P. uncinata* of Captain S. E. Cook, which we believe to be only a mountain variety of this tree. In Britain, *P. sylvestris* is indigenous to the mountainous districts of Scotland; but it appears not to be so to England, though this may probably have been the case at some distant period; as Mr. Winch states that the roots and trunks of very large pines are seen protruding from the black peat moss, at an elevation of nearly 3000 ft. in Yorkshire and Lancashire; cones are also frequently dug up out of the peat bogs, particularly in the latter county. (See p. 21.) In Scotland, it grows at the height of 2700 ft. on the Grampian Mountains; at the height of 2300 ft. on Ben-na-Buird, in Aberdeenshire; and as high, or higher, on the mountains near Loch-na-Garr. (*Watson.*)

In all these various situations, the Scotch pine is always found on soils dry, sandy, gravelly, granitic, or argillaceous, but least frequently on such as are calcareous. The largest trees and finest timber in the Highlands of Scotland are found on light hazelly loam; on a cold, but dry, subsoil, generally granitic rock. The roots of the tree, in indigenous forests, run along the surface, and even rise above it; and the tree seems to derive a great part of its nourishment from the black vegetable mould formed by the decay of its own leaves. The wind frequently carries the seeds of this tree to marshy surfaces and peat bogs; but there, as Sir Thomas Dick Lauder observes, it is always stunted in growth, and soon sickens and dies. In the higher parts of Aberdeenshire, in the vicinity of the Dee and the Spey, where the surface is the most elevated of any land in Scotland, it is only in the valleys, on the borders of these rivers, and in the smaller vales on the banks of tributary torrents, consisting of alluvial soil, in the gentle slopes at the bottoms of the hills, or in the elevated recesses of the mountains, that the native pine thrives, and becomes valuable timber. (*Grant of Monymusk in Pontey's Forest Pruner*, ed. 3., p. 60.) The soil of the Forest of Braemar is a light gravel, formed of

the debris of granitic rock ; there is a considerable extent of surface, in which rocks of granite, porphyry, and gneiss rise in the most precipitous manner ; and some other parts entirely covered with peat bog ; but, on the rocks, the trees, where they occur, have dwindled to mere bushes ; and great part both of the rocky surface and of the bog is entirely destitute of vegetation. A Report on the native Pine Forests of Scotland, by Mr. John Grigor, nurseryman and seedman of Forres, and for which he received the Highland Society's silver medal, will be found in the *Transactions* of that body, vol. xii. p. 122. The following is a brief abstract of this Report :—

Abernethy Pine Forest, the property of the Earl of Seafield, stands on the southern extremity of Morayshire, on the south side of the Spey, and is one of the most ancient forests in Scotland. The surface is partly hilly and partly level. The soil is principally composed of thin sandy peat, with a subsoil of hard, hazelly-coloured gravel ; and, in some parts, it is a black mould mixed with sand, and very stony. The timber produced is very resinous. Great part of it was burnt down by accident in 1746 ; but a new crop of trees has risen from the ashes, and the forest now produces excellent timber. Mr. Grigor saw trunks barked, and prepared for floating, 10 ft. 7 in. in length, 6 ft. in girth at the root end, and 5 ft. 2 in. at the other end. The number of annual layers indicated 73 years of age. The finest specimens are understood to be at Reynloit, one of the largest of which Mr. Grigor found from 10 ft. to upwards of 13 ft. in circumference, at 1 ft. from the ground ; and at 8 ft. from the ground from 9 ft. to 12 ft. ; tapering with a clean trunk to the height of from 20 ft. to 35 ft., and shooting up to the entire height of from 40 ft. to 65 ft. These very old trees stand on low and level ground, on the side of the Nethy ; but perhaps the finest tree in this forest stands on a steep hill side adjoining, though not highly situated, which measures in circumference, at the height of 1 ft. from the surface, 13 ft. 3 in., and at 8 ft. high, 12 ft. It tapers to 32 ft. of trunk, its whole height being about 50 ft., with a top branching like an oak ; to which all the large trees, in point of form, bear a strong resemblance. A few yards distant from this tree, one of similar dimensions had lately been felled, the stump and roots remaining to indicate its size. The annual rings of this root indicate the age of 242 years, and that of the top, 224. The top lay at the distance of 27 ft. from the root, and Mr. Grigor imagines that the tree had grown about that length in 18 years ; that being the number of years intervening between the ages of the root and top. Several others had been felled of nearly the same size, which had almost attained the age of 200 years. Mr. Grigor observed, from the size of the interior layers, that the trees had rapidly advanced in growth between the ages of 8 and 70, the growth having afterwards diminished ; and, eventually, the outside layers, although distinct enough to be numbered, are very minute, and the whole timber is equally strong, hard, and red, to within less than an inch of the bark. Many of them had been thrown down by the great flood of 1829 ; the stumps of which still remain, and show that the roots had derived all their nourishment from the surface soil, none of them being more than 1 ft. from the surface, where the subsoil is hard and gravelly. They are discernible above ground ; and each forms a rib, to the height of several feet, on the side of the trunk. The soil on which these large trees have been produced is sandy moss, to the depth of from 4 in. to 8 in., lying for the most part on a brown gravel of several yards in depth ; and in some parts the subsoil is more fertile, and of a blackish colour, with a mixture of large stones. These soils produce only the following small variety of plants :—*Calluna vulgaris*, *Vaccinium Vitis idæa*, *V. Myrtillus*, *Hypochæris radicata*, *Bléchnum boreale*, and a species of *Scirpus*. (*High. Soc. Trans.*, xii. p. 124.)

Duthel Pine Forests, also the property of the Earl of Seafield, stand north of the Spey, to the west of Abernethy. The surface is mountainous, and the best trees grow in the lowest grounds, and on the sloping sides of the bases of the mountains. The soil is a thin peat, on a rich subsoil of thin brown mould. Mr. Grigor examined several trees, varying from 112 to 126 years of

age, and girding from 6 ft. to 12 ft. at 1 ft. from the ground, consisting of excellent timber, with the sap wood varying from 1 in. to 2½ in. in thickness. The river Dulnain ornaments these glens, floats the timber, and impels saw machinery.

Rotheinchas Forest is the property of Sir John Peter Grant. The surface is irregular, the hollows for the most part marshy, and the soil and subsoil of the elevated portions dry and sandy. The old trees are chiefly cut down, but many patches still remain. The pines are not so remarkable for their girth, as for their extraordinarily tall and smooth trunks. Mr. Grigor found trees measuring, at 6 ft. high, 4 ft. 6 in. in circumference, with a trunk containing nearly of the same girth to the height of about 35 ft. The average height of the trees he found about 70 ft., and their age from 120 to 125 years. The trees stand so closely, that the surface of the ground, within the masses, is almost destitute of herbage; and the largest trees are uniformly found on the outskirts. The progress of young trees in this forest appears to be at the rate of 9 ft. 6 in. in 15 years.

Glenmore Forest, the property of His Grace the Duke of Richmond, is situated in a glen surrounding a lake. The surface soil is a thin sandy peat; and the subsoil a rich brown clay, which feels quite soft to the touch. The trees grow slowly till they are at the age of 12 years, which Mr. Grigor conjectures to be owing to their roots not penetrating earlier into the rich subsoil. The average rate of growth of young trees, in 10 years, is 5 ft. 6 in. There are few old trees remaining; the greater part having been felled and carried away by Mr. Osbourne (see p. 2161.), who completed his contract in 1804. Some scattered trees are yet standing at great distances, which are very picturesque in appearance, with trunks measuring from 9 ft. to 10 ft. in circumference; but knotty, with bushy heads, and of no value as timber, having evidently been left on that account.

Plantations at Castle Grant. In addition to the natural forests, Mr. Grigor notices the plantations on the estate of Castle Grant, where the Scotch pine has made extraordinary progress; trees, apparently still young, having trunks 9 ft. 6 in. in circumference, and being from 60 ft. to 70 ft. high. These trees stand on a surface of rich black earth, on a subsoil of gravelly sand; but, unfortunately, Mr. Grigor had not an opportunity of ascertaining their age, so as to calculate their rate of growth.

"*The Soil in the Highland Forests,*" Mr. Grigor observes, "is found of very different qualities, which, in some measure, regulates the quality of the timber. The richest ground produces the largest trees, consequently, the timber is not so fine in the grain as that grown on sand or poor gravel; but the quick-grown trees appear as full of resin, as healthy, stand to as great an age, and are as red when cut up, as those which grow on poor soil. In general, the soil of the native Highland forests is superior to that on which firs are commonly planted throughout the low country. Neither poor soil nor bad climate can account for the superiority of the Highland pine, as the forests are generally situated in glens, or in the most sheltered slopes of the hills. Natural birch and alder are frequently met with in these forests, but none are large or valuable; the latter not being confined, as might be supposed, to the lowest grounds, but frequently found at considerable heights on the hills. It is very rare to see any other trees in the vicinity of these forests; but I observed an ash standing alone, and much exposed, on the western extremity of the parish of Inverallen, and on the north of the Spey, opposite Abernethy. Perhaps another hardwood tree is not to be found within a mile of this one. At 1 ft. from the surface, it measures 20 ft. 9 in. in circumference; at the height of 8 ft., it measures 14 ft. 10 in.; at the height of 13 ft., it is divided into five limbs; and its whole height is about 60 ft., several of its large branches having been blown down. The trunk is hollow in the centre, but its leaves have a healthy appearance. The surface of the ground where it stands is rendered fertile from its decayed foliage, and by the tree affording a shelter for sheep, which pasture on the surrounding heath. The subsoil is of a sandy

clay, inferior to the generality of the subsoil in Duthel and Glenmore. The quality of soil in the Highlands seems, in no degree, to alter the external appearance and figure of the pines. Under every circumstance, they assume a rough and shaggy form. In general, they are older than most plantations throughout Scotland, and are of greater size, even in proportion to their age. Notwithstanding this, it is very uncommon to see a single tree in a decaying state. We observed several trunks that had a few feet of timber scooped out from the side of each, to be used as *candles* by the cotters, yet the trees continue quite green and healthy, with the hollows overhung with turpentine icicles several inches in length. The pines grown in these districts appear to be of one species, and differ from the great bulk of those produced in the low countries of Scotland in the following respects: — The Highland Pine is of a more robust and shaggy appearance. In early life it grows, although crowded together, to a greater girth; it is found to attain a greater size on very wet ground; its wood is redder and harder, consequently more durable, and is found to be more inflammable. It produces very few fertile flowers or cones, and what it does produce are uniformly found to be rounder, smaller, and whiter; and it outlives many generations of the common cultivated fir, and ultimately attains a larger size. It may be difficult to ascertain the differences in plants necessary to constitute a distinct species, but, if the superiority of the Highland pine to the common tree of the low countries should not be attributed to a difference in kind, the great proportion of the trees in Scotland, by repeated cultivation, must have lamentably degenerated; since it is known, that thousands of the common fir have arrived at maturity, and thousands have died of old age, without ever producing timber in any respect comparable to that of the districts now attempted to be described; and they who aim not to propagate these magnificent objects of nature, overlook that analogy which is every where observable in the works of creation." (*Ibid.*)

The influence of these various climates and soils on the Scotch pine is so great as almost to change its character. In Spain, and in the south of France, it flowers in March; in the climate of Paris, about the end of April; in that of London, about May; and in the Highlands of Scotland, and in Norway, it flowers from the beginning till the middle of June. On the north side of the Highland and Norwegian mountains, where it is crowded together, and on the plains of the north of Germany and Russia, where the trees also stand in close woods, they are drawn up to a great height, and produce clean straight timber. On elevated irregular surfaces, and in very poor soil, the trees, when crowded, are often stunted; and, when scattered, become tortuous bushes, or low branchy trees. The leaves and cones vary, in these situations, as much as the entire tree; and the quality of the timber as much as the exterior appearance.

History. The *Pinus sylvestris* was doubtless known to the Greeks and Romans. (See p. 19.) Pliny, as we have seen (p. 2112.), expressly mentions the wild pine, which was called *pityda*, from the name of the nymph *Pitys* (see p. 2121.); and that the fruit of it was considered an excellent remedy for a cough. (lib. xv. c. 10.) The first modern record of the tree is by Matthioli, who calls it *Pinus sylvestris montana*; and the first of these epithets, *sylvestris*, was adopted as a specific name by Linnæus. Miller, in the earlier editions of his *Dictionary*, made four species, *P. sylvestris*, *P. rubra*, *P. tatarica*, and *P. montana*; but these are now (as we have seen, p. 2150.) considered by most botanists as only varieties; viz. *P. s. vulgaris*, *P. s. horizontalis* or *P. s. rigensis*, *P. (s.) pumilio*, and *P. (s.) p. Mughus*. The different qualities of the timber of this tree, according to the soil and situation in which it was first grown, seem to have been ascertained in England in the time of Evelyn; but it was not till long after his time that it was generally known that the red wood and yellow deals and planks of the Baltic, so generally esteemed throughout Europe, were produced by the Scotch pine. This point seems to have been determined by Pallas and Cox, and made generally known by the latter in his *Travels*, which were published in 1784. The tree only began to be planted

in Britain about the end of the 17th century; and about the middle of that following, some planted trees, more especially in Scotland, having been cut down, and employed as timber, were found to be of inferior quality to imported timber, or to that grown in natural forests. Dr. Walker, writing near the end of the last century, observes that the Scotch pine had been planted every where in abundance, but had not yet had time for its timber to arrive at perfection. The timber of this tree, he adds, is depreciated, because it is white, soft, and perishable; though he argues that this is merely from want of age in the tree. In the course of years, he says, this white wood will become red; and the planted fir will become more and more valuable in quality, and be held in greater estimation. The prejudice against the wood of the Scotch pine seems to have been at its greatest height between 1790 and 1810; for Marshal, writing in 1796, says, the Scotch pine "should be invariably excluded from every soil and situation in which any other timber tree can be made to flourish. The north aspect of bleak and barren heights is the only situation in which it ought to be tolerated; and even there the larch is seen to outbrave it. In better soils, and milder situations, the wood of the Scotch fir is worth little; and its growth is so licentious, as to overrun every thing which grows in its immediate neighbourhood; and this renders it wholly unfit to be associated with other timber trees; we therefore now discard it entirely from all useful plantations." (*Plant. and Rur. Orn.*, i. p. 146.) Soon afterwards (in 1798), Mr. Thomas Davis, a planter and manager of timber of great experience, and high and deserved repute, who had then had the care of the Marquess of Bath's plantations, near Warminster, for 35 years, and who had planted upwards of 25,000 trees a year on poor heathy land, at the foot of the Wiltshire Downs, published a paper in the *Transactions of the Society of Arts*, vol. xvi., in which he refutes the generally received opinion, that the English-grown Scotch pine was of no use as timber, by facts that had come within his own knowledge. "I can assert from experience," he says, "that, for strength and durability, English-grown fir is equal to any foreign deal whatever. I allow that the Scotch fir (although it is, undoubtedly, the real yellow deal) is seldom of so fine a grain as the foreign yellow deal; but this is certainly occasioned by the rapidity of its growth, and its having too much room to throw out large side branches. Lord Bath's Scotch firs, which are known to have been planted in 1696, are from 2 ft. to 3 ft. in diameter; whereas the best Christiania deal, although evidently 100 years old, is seldom above 1 ft. in diameter; and its knots, which denote the size of its side branches, are small and inconsiderable, therefore evidently appearing to have grown slow and close together. We have a cart-house on Lord Bath's estate, which was built above 80 years ago, out of small firs, which is now perfectly sound and upright; and, for the last 20 years, all the carpenters of the country have used small firs for rafters, &c., with success; and no timber is more ready of sale." (p. 125.) In Lambert's *Pinus*, ed. 2., vol. ii. p. 177., is published a letter to nearly the same effect, from the same writer; and the same facts have been lately (1837) confirmed to us by Mr. Davies's son and successor, the present Thomas Davies, Esq., of Portway House, near Warminster. Pontey, in his *Forest Pruner*, published in 1805, also defends the Scotch pine against the "almost universally prevalent" prejudices against it. "At first sight," he says, "it seems natural to suppose such prejudices must be well founded; though, in fact, they rest upon no better foundation than the prejudice that prevailed, less than a century ago, against foreign fir timber; namely, a prejudice, the effect of inexperience. At that time, no workman could be found credulous enough to suppose that a roof made of it would answer the purpose as well as one made of oak; and yet now the tide of opinion is completely turned. An article which, apparently, has but little of either strength or durability is found, by experience, to possess a very extraordinary degree of both." (*Forest Pruner*, p. 52.) Mr. Pontey traces the prejudice to the use of young trees as timber; the absurdity of which, he says, where strength and durability are required, every one will admit.

The history of the indigenous pine forests in Scotland is thus given by Sir T. D. Lauder. Commencing with the Western Highlands, he notices the remains of the Rannoch Forest, on the confines of the great counties of Perth, Inverness, and Argyll, which, he says, has been "unmercifully slaughtered," in consequence of the high price of Baltic timber during the late wars. "The roots that exist, and the occasional single trees and groups which may still be seen here and there, in situations not easily accessible, show that this forest stretched far and wide across the country, meeting with those which now remain on the Dee, the Spey, the Findhorn, the Ness, and the Beauley; as well as those connected with the Glen-mor-na-albin, or Great Caledonian Glen, and with the Glengarry, Lochiel, Glen Nevis, and more western sylvan districts. Of these remnants, none were more extensive, or more esteemed for their timber, than the forests of the Spey and the Dee. The Abernethy forests still continue to furnish a great quantity of very fine timber. In 1730, a branch of the York Building Company purchased 7000*l.* worth of timber; and, by their improved mode of working it up, by saw-mills, &c., and their new methods of transporting it on floats to the sea, they introduced the rapid manufacture and removal of it which afterwards took place throughout the whole of the sylvan districts. About the year 1786, the Duke of Gordon sold his Glenmore Forest to an English company for 10,000*l.* [It will be perceived, that there is a discrepancy between this account and that of Mr. Grigor, p. 2161., which, however, is of no great consequence.] This was supposed to be the finest fir wood in Scotland. Numerous trading vessels, some of them of above 500 tons burthen, were built from the timber of this forest; and one frigate, which was called the Glenmore. Many of the trees felled measured 18 ft. and 20 ft. in girth; and there is still preserved at Gordon Castle a plank nearly 6 ft. in breadth, which was presented to the duke by the company. But the Rothiemurchus Forest was the most extensive of any in that part of the country: it contained above 16 square miles. Alas! we must now, indeed, say that it was; for the high price of timber hastened its destruction. It went on for many years, however, to make large returns to the proprietor, the profits being sometimes above 20,000*l.* in one year. The Forests of Glenmore and Rothiemurchus, though belonging to different estates, were so united as to form, in reality, one continuous forest; and they are now equally denuded of all their finest timber. The Braemar and Invercauld Forests, on the Dee, are as yet most entire. They are very extensive, and some very magnificent pines are to be found among them; but the destructive axe has been let loose on that of Mar; and we fear that nothing but a reduction in the price of timber will save it from the ruin which has befallen those we have mentioned. It is curious to observe, in the Rothiemurchus Forest, and in all the others, how the work of renovation goes on. The young seedlings come up as thick as they do in the nurseryman's seed-beds; and in the same relative degree of thickness do they continue to grow, till they are old enough to be cut down. The competition which takes place between the adjacent individual plants, creates a rivalry that increases their upward growth; whilst the exclusion of the air prevents the formation of lateral branches, or destroys them soon after they are formed. Thus, Nature produces by far the most valuable timber; for it is tall, straight, of uniform diameter throughout its whole length, and free from knots: all which qualities combine to render it fit for spars, which fetch double or triple the sum per foot that the other trees do. The large and spreading trees are on the outskirts of the masses, and straggle here and there in groups or single trees." (*Lauder's Gilt.*, vol. i. p. 177.) These last are the trees which are described by tourists, and drawn by artists, as the Highland pine. (See fig. 2052. in p. 2164.)

The pine forests on the Continent, and especially in the north of Europe, have suffered like those of the Highlands of Scotland, and from the same causes; but, on the Continent, the work of reproduction goes on with rapidity, while this is the case in only a few of the Highland forests. The reason is, that

the Scotch forests are for the most part pastured with cattle and sheep, which, as well as the deer that are found wild in these forests, browse upon the seedling trees, and prevent them from attaining the size of timber. The forests of Sweden, Norway, and Russia are also pastured by cattle, but in a very slight degree; the proportion of cattle to the range of country open to them being incomparably smaller than in the Highlands. In France and Germany, the native forests are, for the most part, carefully enclosed, and placed under the care of woodmen, who are under the general direction of scientific men; and, consequently, for whatever trees are cut down, a succession of young ones, either supplied by nature or art, are protected.

In Norway, according to James White, Esq., an extensive proprietor of pine and fir forests in that country, the only tall straight trees, fit for exportation, as timber, either of *P. sylvestris* or *Abies excelsa*, are found in sheltered situations on the plains, and on the sides of the mountains; and always in a good soil, that would bring oak, or any other kind of timber tree, to perfection. On the sea shore, and in all elevated exposed places in the interior, and also where the trees stand singly, or in small groups on plains, they are stunted, short, or with branchy heads, so as to be fit only for fuel. In an estate belonging to Mr. White, of 5600 acres, there are 250 acres of naked rock and bogs; of the remaining 5350 acres, one tenth part consists of the stunted trees already alluded to, or of trees only half grown. There remain 4118 acres

of thriving wood, all situated on the sides of hills, in narrow valleys, or on plains; and all the trees are growing close together and sheltered, on good soil, the basis of which is the debris of granitic rock. On each acre of this good soil there are from 320 to 500 trees, of which above 30 in each acre are considered full grown, and fit for timber; that is, from 130 to 200 years of age. The diameter of the trunks of these trees, at about 1 ft. from the ground, is from 16 in. to 20 in.; and at from 52 ft. to 63 ft. in height, from 4 in. to 6 in. Thus the average dimensions of the Scotch pine and spruce fir timber produced by such an estate are as follows:—Length of the log, or tree, 57 ft. 6 in.; diameter, at the lower end, 18 in.; and, at the upper end, 5 in. Each log, or tree, may be sawn up into two deals, 9 in. wide, and 3 in. thick, fit for the English market; and two other deals 8½ in. wide, and ½ in. thick, fit for the French market. The manner in which these deals are cut, so as to include only a small portion of the sap wood, is shown in the cross section, *fig. 2053.*, in which the shaded part, *a*, represents the sap wood; *bb*, the two English deals; and *cc*, the two French deals. Another mode of cutting these trees into planks is shown in *fig. 2054.*, in which *d* is an English deal, 9 in. by 3 in., and *ee* are two battens, each 7 in. by 2½ in. When the timber is intended for masts, the tree is simply barked, and a portion of the sap wood is cut off, after which it is sent down to the sea port, and shipped. (*Reports, &c.*, for 1821 and 1835; and MSS. communicated by Mr. White.)

By far the greater quantity of pine timber employed both in civil and naval construction in Britain is imported from the Baltic, and from the coast of Norway. One London builder alone (the Mr. White mentioned above), who

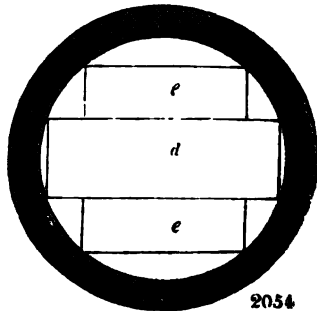
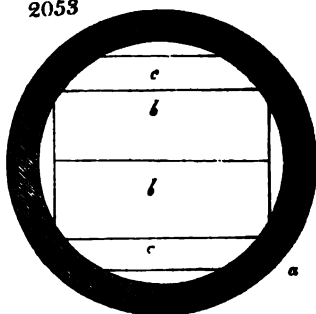

imports his own timber, is the owner of pine and fir forests, in Norway, of 20,000 acres in extent.

Artificial plantations of the Scotch pine have been made to a great extent, not only in Britain, but in France and Germany, during the present century. From 1780 or 1790, to 1815, many thousands of seedlings of Scotch pines were sent by the nurserymen of Aberdeen and Edinburgh to the English nurserymen and proprietors, and more particularly to the proprietors of estates in Wales. These trees were planted, not always with a view of producing timber, but rather for the purpose of sheltering other trees which were considered of greater value, such as the oak, &c. Both in Scotland and in England, also, plantations of Scotch pine were formed solely for the purpose of being cut down as a crop at the end of 25 or 30 years; when the produce was disposed of for local purposes, and the ground afterwards either planted with broad-leaved trees, subjected to the plough, or laid down in pasture. At the present time, the Scotch pine is still in general use as a tree for sheltering others, especially the oak (see p. 1800.), and also for the sake of its timber; and, for the latter purpose, the red-wooded or Highland variety is generally planted, at least in Scotland.

Poetical Allusions. The pine mentioned by the Roman poets was probably *P. Pinæ*; but that of Milton is, no doubt, the *P. sylvestris*:— Speaking of the fallen angels, he says, —

—“ Faithful how they stood,
Their glory wither'd; as when Heaven's fire
Hath scathed the forest oaks, or mountain pines,
With singed top, their stately growth, though bare,
Stands on the blasted heath.”

Sir Walter Scott, also, mentions the Scotch pine in the following lines:—

“ And higher yet the pine tree hung
His shatter'd trunk, and frequent flung
Where seem'd the cliffs to meet on high
His boughs athwart the narrow'd sky.”

Churchill, with reference to the growth of the Scotch pine in various soils and situations, says, —

—“ That pine of mountain race,
The fir, the Scotch fir, never out of place.”

Wordsworth has frequent allusions to this tree:—

“ Unheeded night has overcome the vales:
On the dark earth the baffled vision fails:
The latest lingerer of the forest train,
The lone black fir forsakes the faded plain.” Vol. i. p. 67.

“ And there I sit at evening, when the steep
Of Silver-how, and Grasmere's placid lake,
And one green island, gleam between the stems
Of the dark firs — a visionary scene.” Vol. ii. p. 579.

—“ While o'er my head,
At every impulse of the moving breeze,
The fir grove murmurs with a sea-like sound,
Alone I tread this path.” Vol. ii. p. 280.

Keats, also, appears to allude to this tree, when he says:—

—“ Fir trees grow around,
Aye dropping their hard fruit upon the ground.”

Properties and Uses. So much has been said on the uses of the pine and fir tribe generally, in our introduction to the *Abietinæ* (p. 2123.), that we have only here to notice such uses as are peculiar to the species before us. It is universally allowed, that the timber of the Scotch pine makes the best masts for ships; and, indeed, we are not aware of any use to which the timber of the genus *Pinus* is applicable, that that of the Scotch pine will not fulfil. All the resinous products common to the pine and fir tribe may be obtained from it, and this is the case in the north of Europe; but, in Britain, the tree is seldom used for any other purpose than for timber. The timber of this species, when grown in a suitable soil and situation, is fit for being employed in construction, when from 80 to 100 years of age, at which age the trunk will

be found from 2 ft. to 3 ft. in diameter, according to the circumstances under which it has grown; but it will continue growing for a much longer period, and the timber will increase in value as well as in bulk. The wood varies in colour from a yellowish white to a brownish red, the latter being produced by the presence of resin. That wood which grows slowest, and in the coldest climate, is considered the best, and it is generally of the darkest colour. That which grows with the greatest rapidity is commonly white, soft, and spongy in texture, and without resin. A slow-growing tree will not produce layers more than the tenth of an inch thickness, while one of rapid growth may have the layers from a sixth to a fourth of an inch in thickness. The red, or resinous, wood is almost exclusively of very slow growth: it is hard, dry, and does not adhere to the saw; while the more rapidly grown wood, when it is resinous, chokes the saw, and has a clammy unctuous feel. When rapid-grown wood is without resin, it is white and spongy; and the surface, after the saw, has a woolly appearance. It is evident that such wood can neither be strong nor durable. English-grown Scotch pine, when cut down at 40 or 50 years' growth, has commonly this appearance; but, as we have seen, p. 2161., there are many exceptions. Some of the Russian and Baltic pine timber is often clammy, the saw raising up and pushing before it what the carpenters call strings; while the pine timber of Norway and Riga is generally red and firm.

Masts of Scotch pine are procured from different ports on the Baltic (see p. 2113.), and also from Norway; and not only masts have been obtained, but entire ships have been built, from the Scotch pine forests in Aberdeenshire (see p. 2161.). The most celebrated masts in Europe, however, are those of Riga.

The weight of the wood varies according to its age and other circumstances. A cubic foot, in a green state, weighs from 54 lb. to 74 lb.; and, in a dry state, from 31 lb. to 41 lb. According to the *Dictionnaire des Eaux et Forêts*, the average weight of the timber produced by a full-grown tree, in a green state, will be about 68 lb., and in a dry state, about 40 lb. 5 oz. or 6 oz.; losing about a twelfth part of its bulk in drying: while, according to Varennes de Fenille, it weighs, green, 74 lb. 10 oz.; and dry, 38 lb. 12 oz.; losing only a tenth part of its bulk by drying.

The wood is valued, like that of every other pine, in proportion to its freedom from knots; and it is found that the knots of this species are much more easily worked, and much less liable to drop out of flooring boards, than is the case with knotty boards of the spruce or silver fir. The facility with which the wood of the Scotch pine is worked occasions its employment in joinery and house carpentry, almost to the exclusion of every other kind of timber, wherever it can be procured. It is at once straight, light, and stiff, and, consequently, peculiarly fitted for rafters, girders, joists, &c., which may be made of smaller dimensions of this timber than of any other. In point of durability, if it is kept dry, it equals the oak; more especially if it has been of slow growth, and is resinous.

The timber of the Scotch pine, when it has grown rapidly, on a good soil, and in a favourable climate, such as in most parts of the low country both of England and Scotland, is found, when not of more than 20 or 30 years growth, to consist chiefly of sap wood, and, hence, to be of very short duration when employed in buildings, or for any other rural purpose. To render it more durable, Mr. Menteach, of Closeburn, in Dumfriesshire, has been in the practice, for upwards of 40 years, of steeping all his Scotch pine timber in lime water, after it has been cut out, and fitted for the different purposes required. It would appear, either that the alkali of the lime neutralises, in some degree, the albuminous matter of the soft wood; or that the water acts as a solvent, and extracts a part of it; for, while Scotch pine of 20 or 30 years' growth seldom lasts 30 years before it is destroyed by worms, timber of the same age, which Mr. Menteach has steeped, has already lasted 40 years, and is as sound as when first put up. The solution of lime water is formed by a very small

quantity of quicklime being dissolved in it, and the time of steeping is ten days or a fortnight. The deeper the tank, and the lower the wood is sunk in it, the more effectually will the lime water penetrate into the wood. Probably alum water would be still more effective than lime water, and the corrosive sublimate used in Kyanising would, doubtless, be the most effective of all.

As fuel, the wood of the Scotch pine lights easily, and burns with great rapidity; but it produces a black and very disagreeable smoke. Its value as a combustible, compared with that of the beech, is as 1536 to 1540. Its charcoal is excellent, and is to that of the beech as 1724 is to 1600. The faggot wood of the Scotch pine is valued by the chalk and lime burners of England more than any other, on account of its rapid burning and intense heat, and consequent saving of time in attending on the kilns. The resinous juice, whether exuding naturally, or procured by incision and distillation, produces tar, pitch, rosin, turpentine, and the essential oil of turpentine employed in house-painting. Lampblack of an inferior quality is made from the smoke of the wood; and the leaves and branches are burned for potash, though of this salt the tree yields only a small quantity. In the north of Russia, and in Lapland, the outer bark is used, like that of the birch, for covering huts, for lining them inside, and as a substitute for cork for floating the nets of fishermen; and the inner bark is woven into mats, like those made from the lime tree. Ropes are also made from the bark, which are said to be very strong and elastic, and are generally used by the fishermen. The Laplanders, and other people of the extreme north, are said to grind the inner bark of the pine into a coarse flour, for the purpose of making bread. This, though not true in the sense in which it is generally taken, is still founded on fact. Mr. Laing, in his *Journal of a Residence in Norway*, states that he had been disposed to doubt the use of fir bark for bread; but he found it more extensive than is generally supposed. In Norway, it is the custom to kilndry oats to such a degree, that both, the grain and the husks are made into a meal almost as fine as wheaten flour. In bad seasons, the inner bark of young Scotch pines is kilndried in a similar manner to the oats, and ground along with them, so as to add to the quantity of the meal. The present dilapidated state of the forests, in districts which formerly supplied wood for exportation, is ascribed to the great destruction of young trees for this purpose in the year 1812. The bread baked of the oat and pine meal is said to be very good. It is made in the form of "flat cakes, covering the bottom of a girdle or frying-pan, and as thin as a sheet of paper, being put on the girdle in nearly a fluid state." When used at table, these cakes are made crisp by being warmed a little. (*Laing's Journal of a Residence in Norway*.) According to Pallas, the young shoots, as well as the inner bark, are ground and used as bread in some parts of Siberia. The leaves and branches are eaten by cattle and sheep in severe weather; and they are said, by Delamarre and other French authors, to preserve sheep from the rot. Evelyn tells us that pine chips are used as a substitute for hops; and other writers inform us that the young shoots, stripped of their leaves just when they are beginning to appear, are sought for with avidity by the children of the peasantry, who eat them. The milky juice found on the liber of the young trees is also said to be very sweet. The log houses of Russia, Poland, and Sweden are almost entirely made of the trunks of Scotch pine, notched, and let into each other, as already described, p. 2123.

In Russia, roads are formed of the trunks of the Scotch pine. The trees selected are such as have trunks from 6 in. to 1 ft. in diameter at their thickest end. The branches of these are lopped off, to the length of 12 ft. or 15 ft., according to the width which the road is intended to be, and the rest are left on. The ground being marked off for the road, and made somewhat even on the surface, the trees are laid down across it side by side, the thick end of one trunk alternating with the narrow part of another, and the branches at the ends of the trunks forming a sort of hedge on each side of the road. The interstices of the trunks are next filled up with soil, and the road is completed. The hedges formed by the branches on the extre-

mities of the trunks are found extremely useful after snow has fallen, and before it has become hard with the frost, and also on the commencement of a thaw, in indicating to the traveller when his horses are getting too near the edge of the road. Roads of this rude description are peculiarly suitable for marshy ground, and are very common in the interior of Russia, and also in some parts of Poland. Recourse is also had to them in the commencement of back settlements in North America. In 1814, the greater part of the road from Petersburg to Moscow was of this kind; but it has since, we understand, been Macadanised. The practice of paving streets and court-yards with blocks, cut from the trunks of Scotch pines, and set up endwise, has been already mentioned, p. 2123.

Mode of procuring the resinous Products of the Scotch Pine in the North of Europe. The turpentine obtained from the Scotch pine is so inferior to that of the silver fir, that very little is made use of in the way of commerce, except for the coarsest kinds of work. To procure it, a narrow piece of bark is stripped off the trunk of the tree in spring, when the sap is in motion, and a notch is cut in the tree, at the bottom of the channel formed by removing the bark, to receive the resinous juice, which will run freely down to it. As it runs down it leaves a white matter like cream, but a little thicker, which is very different from all the kinds of resin and turpentine in use, and which is generally sold to be used in the making of flambeaux, instead of white bees' wax. The matter that is received in the hole at the bottom is taken up with lades, and put into a large basket; a great part of this immediately runs through, and this is the common turpentine. It is received into stone or earthen pots, and is then ready for sale. The thicker matter, which remains in the basket, is put into a common alembic; and a large quantity of water being added, the liquor is distilled as long as any oil is seen swimming upon the water. The oil which is produced in large quantities is then separated from the water, and is the common oil or spirit of turpentine; and the remaining matter, at the bottom of the still, is the common yellow rosin.

Tar is procured from the Scotch pine in great quantities in the north of Europe, and is considered very superior to that produced in the United States from *P. resinosa*, *Stròbus, australis*, and other species. The process followed in Sweden, by which both tar and charcoal are obtained, though the latter is there of little value, is thus described by Dr. Clarke:—"The inlets of the gulf (Bothnia) every where appeared of the grandest character; surrounded by noble forests, whose tall trees, flourishing luxuriantly, covered the soil quite down to the water's edge. From the most southern parts of Westro-Bothnia, to the northern extremity of the gulf, the inhabitants are occupied in the manufacture of tar; proofs of which are visible in the whole extent of the coast. The process by which the tar is obtained is very simple; and, as we often witnessed it, we shall now describe it, from a tar-work we halted to inspect upon the spot. The situation most favourable to the process is in a forest near to a marsh or bog; because the roots of the Scotch pine, from which tar is principally extracted, are always most productive in such places. A conical cavity is then made in the ground (generally in the side of a bank or sloping hill); and the roots together with logs and billets of the wood, being neatly trussed in a stack of the same conical shape, are let into this cavity. The whole is then covered with turf, to prevent the volatile parts from being dissipated, which, by means of a heavy wooden mallet, and a wooden stamper worked separately by two men, is beaten down, and rendered as firm as possible above the wood. The stack of billets is then kindled, and a slow combustion of the pine takes place, as in making charcoal. During this combustion the tar exudes; and, a cast-iron pan being fixed at the bottom of the funnel, with a spout which projects through the side of the bank, barrels are placed beneath this spout to collect the fluid as it comes away. As fast as these barrels are filled, they are bunged, and are then ready for immediate exportation. From this description, it will be evident that the mode of obtaining tar is by a kind of distillation *per descen-*

sum; the turpentine, melted by fire, mixing with the sap and juices of the pine, while the wood itself, becoming charred, is converted into charcoal. (*Trav. in Scand., &c.*)

When pitch is to be made, the tar, without any thing being added to it, is put into large copper vessels (fixed in masonry, to prevent any danger of the tar taking fire), and is there suffered to boil for some time; after which it is let out, and, when cold, hardens and becomes pitch.

Tar and charcoal are obtained in Russia much in the same manner as in Sweden, from the bottoms of the trunks and the roots of the trees. In Germany, the process is conducted with very great accuracy, and is described in detail by Hartig, in his translation of Du Hamel's *Traité des Arbres, &c.*, vol. i. p. 15.; and it is also given in the *Dictionnaire des Eaux et Forêts*, art. Résine, p. 731. In France, it is conducted in a similar manner; though the resinous products of the pine and fir tribe, in that country, are generally obtained from the pinaster, as will be described under that tree. In Britain, tar is sometimes extracted from the roots of the Scotch pine in the Highlands, in a rude manner, for local purposes. The country people, having hewn the wood into billets, fill a pit dug in the earth with them; and, setting them on fire, there runs from them, while they are burning, a black thick matter, which naturally falls to the bottom of the pit, and this is tar. The top of the pit is covered with tiles to keep in the heat; and there is at the bottom a little trough, out of which the tar runs like oil: if this hole be made too large, it sets the whole quantity of the tar on fire; but, if small enough, it runs quietly out. In England, a piece of a branch of the tree is sometimes put in a smithy fire, at one end, while the sap and resinous matter which oozes out at the other is scraped off from time to time, and mixed with tallow for greasing the wheels of carts.

Flambeaux of the roots and trunks of the pine are in use both in Britain and in the north of Europe. Hall, in his *Travels in Scotland*, relates a story of a bet made in London by a Highland chief, that some massive silver candlesticks, on the table at a gentleman's house where he was dining, were not better, or more valuable, than those commonly in use in the Highlands. The chieftain won his bet, by sending to his estate for four Highlanders of his clan, and producing them with torches of blazing fir in their hands, declaring that they were the candlesticks to which he alluded. (vol. ii. p. 440.) Dr. Howison observes "that the little tallow or oil which the peasantry in Russia can procure is entirely consumed at the shrines in the churches, and before the images in their isbas, or huts." To supply the place of candles, "they take long billets of red Scotch pine, which they dry carefully near their peatches, or stoves, during the tedious winter, and split, as occasion requires, into long pieces resembling laths. When a traveller arrives, or a light is required for any other purpose, one of these laths is lighted at the peatch, and fixed in a wooden frame, which holds it in a horizontal position. It gives a bright flame, but only burns for a short time." (*For. Trees of Russ. in Jam. Jour.*, vol. xii. p. 60.)

As a timber tree, for planting in poor dry soils, and in exposed situations, none can excel the Scotch pine, and it is only equalled by the larch. In Britain, it surpasses every other species of the pine and fir tribe for sheltering other trees, with the exception of the spruce fir, which, being of a more conical shape, admits more light and air to the heads of the trees which are to be drawn up by it. The Scotch pine is, however, altogether unfit for giving shelter in single rows, unless the branches are allowed to remain on, from the ground upwards, and the roots have free scope on every side. Hence, this pine, like every other species of the tribe, is altogether unfit for a hedgerow tree. When planted in narrow belts round fields for shelter, it soon becomes unsightly, unless the trees stand so thin as to allow of their being clothed with branches from the ground upwards. The true situation for this tree, when grown for timber, is in masses over extensive surfaces.

As an ornamental tree, various opinions are entertained of the Scotch

pine; the diversity of which may be partly owing to the great extent to which the tree has been planted in almost every part of the low country of Britain; and the great difference between the tree in these plantations, and in its native habitats, in hilly or mountainous scenery. Even the difference between the tree standing alone or in small groups, and growing in extensive plantations, is so great, that it can hardly be recognised by a general observer to be the same species of tree. In close plantations, which have never been thinned, the trees assume, after a certain number of years, a gloomy sameness of appearance; and, where these are planted in belts, as they often are, along a public road, "daylight may be seen for miles through their naked stems, chilled and contracted as they are with the cold." The timber, also, of trees grown in the fertile soils of the low country, which have been cut down, being so much less strong and durable than Highland or foreign wood of the same kind, is another cause of the tree having got into bad repute, though the great objection to it is its appearance. Mason says, —

—"The Scottish fir, in murky file,
Rears his inglorious head, and blots the fair horizon."

The great contempt in which the Scotch fir is commonly held, says Gilpin, "arises, I believe, from two causes. People object, first, to its colour: its dark murky hue is displeasing. With regard to colour in general, I think I speak the language of painting, when I assert that the picturesque eye makes little distinction in this matter. It has no attachment to one colour in preference to another, but considers the beauty of all colouring as resulting, not from the colours themselves, but almost entirely from the harmony with other colours in their neighbourhood. So that, as the fir tree is supported, combined, or stationed, it forms a beautiful umbrage, or a murky spot. A second source of that contempt in which the Scotch fir is commonly held is, our rarely seeing it in a picturesque state. Scotch firs are seldom planted as single trees, or in a judicious group; but generally in close compact bodies, in thick array, which suffocates or cramps them; and, if they ever get loose from this bondage, they are already ruined. Their lateral branches are gone, and their stems are drawn into poles, on which their heads appear stuck as on a centre. Whereas, if the tree had grown in its natural state, all mischief had been prevented: its stem would have taken an easy sweep, and its lateral branches, which naturally grow with almost as much beautiful irregularity as those of deciduous trees, would have hung loosely and negligently; and the more so, as there is something peculiarly light and feathery in its foliage. I mean not to assert that every Scotch fir, though in a natural state, would possess these beauties; but it would at least have the chance of other trees; and I have seen it, though, indeed, but rarely, in such a state as to equal in beauty the most elegant stone pine. All trees, indeed, crowded together, naturally rise in perpendicular stems; but the fir has this peculiar disadvantage, that its lateral branches, once injured, never shoot again. A grove of crowded saplings, elms, beeches, or almost any deciduous trees, when thinned, will throw out new lateral branches, and in time, recover a state of beauty; but, if the education of the fir has been neglected, he is lost for ever." (*For. Scen.*, i. p. 91.)

The Scotch fir, in perfection, continues Gilpin, "I think a very fine tree, though we have little idea of its beauty; and it is generally treated with great contempt. It is a hardy plant, and is therefore put to every servile office. If you wish to screen your house from the south-west wind, plant Scotch firs, and plant them close and thick. If you want to shelter a nursery of young trees, plant Scotch firs; and the phrase is, you may afterwards weed them out as you please. This is ignominious. I wish not to rob society of these hardy services from the Scotch fir; nor do I mean to set it in competition with many trees of the forest, which, in their infant state, it is accustomed to shelter: all I mean is, to rescue it from the disgrace of being thought fit for nothing else, and to establish its character as a picturesque tree. For myself, I admire its foliage, both the colour of the leaf, and its mode of

growth. Its ramification, too, is irregular and beautiful, and not unlike that of the stone pine, which it resembles, also, in the easy sweep of its stem, and likewise in the colour of the bark, which is commonly, as it attains age, of a rich reddish brown. The Scotch fir, indeed, in its stripling state, is less an object of beauty. Its pointed and spiry shoots, during the first year of its growth, are formal; and yet I have sometimes seen a good contrast produced between its spiry points and the round-headed oaks and elms in its neighbourhood. When I speak, however, of the Scotch fir as a beautiful individual, I conceive it when it has outgrown all the improprieties of its youth; when it has completed its full age, and when, like Ezekiel's cedar, it has formed its head among the thick branches. I may be singular in my attachment to the Scotch fir. I know it has many enemies; but my opinion will weigh only with the reasons I have given." (*Ibid.*) Sir Thomas Dick Lauder, in his commentary on this passage, says, "We agree with Mr. Gilpin to the fullest extent in his approbation of the Scotch fir as a picturesque tree. We, for our parts, confess, that, when we have seen it towering in full majesty in the midst of some appropriate Highland scene, and sending its limbs abroad with all the unconstrained freedom of a hardy mountaineer, as if it claimed dominion over the savage regions around it, we have looked upon it as a very sublime object. People who have not seen it in its native climate and soil, and who judge of it from the wretched abortions which are swaddled and suffocated in English plantations, in deep, heavy, and eternally wet clays, may well call it a wretched tree; but, when its foot is among its own Highland heather, and when it stands freely on its native knoll of dry gravel, or thinly covered rock, over which its roots wander far in the wildest reticulation, whilst its tall, furrowed, and often gracefully sweeping red and grey trunk, of enormous circumference, rears aloft its high umbrageous canopy, then would the greatest sceptic on this point be compelled to prostrate his mind before it with a veneration which, perhaps, was never before excited in him by any other tree." (*Laud. Gilp.*, i. p. 174.) To enable the reader to judge of the correctness of the opinion of Gilpin and Sir Thomas Dick Lauder, with which we entirely agree as to the beauty of this tree, in certain circumstances of age and situation, we have only to refer to figs. 2051. and 2052. in p. 2163. and p. 2164.; to the plates of this tree in our last Volume; and to the beautiful views of scenery in the Highlands, by Robson and Nesfield.

Soil and Situation. A granitic soil, it is generally allowed both by British and Continental writers, is the most congenial to the Scotch pine; and the sand and gravel of the Forests of Rastadt and Hagueneau are composed of the debris of this rock. J. S. Menteth, Esq., has remarked that the Scotch pine does not harden its wood well when growing on the grauwacke; and several others have observed that it is short-lived, and never attains a large size on chalk. The Scotch pine, Sang observes, will grow and flourish in any kind of soil, from a sand to a clay, provided the substratum be rubble or rock; "but in wet tilly soils it ought never to be planted; because, whenever the roots have exhausted the turf, or upper soil, and begin to perforate the sub-soil, the tree languishes and dies." It is justly observed by Mathews, that the natural location of the Scotch pine in poor sandy soils does not result from these soils being best adapted for it, but from its growing more vigorously in them than any other tree. Should any one doubt this, he observes, let him make an excursion into Mar Forest, and there he will find the Scotch pine in every description of soil and situation, but always thriving best in good timber soil; and, in short, not differing very materially, in respect to soil, from the sycamore, the elm, the oak, or the ash. Mr. Mathews also mentions that, though the Scotch pine has a superior adaptation to dry, sharp, and rocky soils, yet there are many situations of poor wet till and clay, and even of peat moss ground, where it would be advantageous to plant the Scotch pine; because, from its roots running along the surface, no other timber tree will thrive so well in such soils. The same author observes that nothing conduces so much to the quality of Scotch pine wood, as the exposure of the tree while growing.

“ Under the great shelter of the close-planted woods, the timber is soft and porous, without much resin; but, under great exposure, especially to dry air, the timber is hard, close, and resinous. This is, however, considerably modified by the soil.” (*On Naval Timber, &c.*, p. 339.) According to Dr. Walker, the Scotch pine may be planted on the thinnest and driest soils, and also in mossy soil, when it is less than 2 ft. in depth, and bottomed with gravel rather than with clay. It may also be planted in sand on the sea shore, and on mountains to the height of 1400 feet. (*Highlands of Scotland*, ii. p. 287.) In England, it is found that the Scotch pine will grow on every soil; but that, among dry soils, the one on which it thrives the least is chalk. The worse the soil, the farther the plants should be placed apart, in order to insure their vigorous growth; but, as this distance will admit of their becoming branchy trees, what the timber gains in strength and durability, it will lose in its fitness for many purposes, from the number of the knots produced by leaving on the branches.

Propagation and Culture. The Scotch pine produces cones at the age of fifteen or twenty years; and every cone generally contains from 60 to 100 seeds. The cones are gathered in the months of December and January, and laid in a dry loft, where they will keep good for a year or two, if not wanted for sowing; and whence they may be taken in early spring, and exposed to the sun, or at any season and slightly dried on a kiln, as already directed, p. 2131. Eleven imperial gallons, or about a bushel and a half, of cones, will afford 1 lb. of seed with the wings on, or from 13 oz. to 14 oz. without wings. A bushel and a half of seeds, with the wings on, weigh 12 lb.; and without the wings, 26 lb. As might be expected, the seed keeps longest when the wings are left on. If kept in a dry place, and turned over occasionally, to prevent it from heating, the seed will keep fresh several years; but its vitality is very doubtful after the second year. Old seeds are easily proved by sowing a few in a pot, and placing it in heat in a moist atmosphere; when, if the seeds are fresh, they will come up in a few days. In general, however, the freshness of the seeds may be ascertained by opening them; and, if the kernel is plump and fragrant, there can be little doubt of their germinating. In the *Dictionnaire des Eaux et Forêts*, it is said that, in France, the seeds of the spruce, which are of a reddish colour, are sometimes turned black by means of powdered charcoal, and sold for those of the wild pine; but nothing of this kind takes place in Britain, as the seeds of the latter species are of all the most abundant, and consequently the cheapest. The seeds should be sown in beds in light rich soil, and covered very slightly, perhaps from a sixteenth to a fourth of an inch, according to the soil, situation, and climate. Sang directs the seeds to be sown so as to rise at the distance of a quarter of an inch from one another, and the covering to be $\frac{1}{2}$ in. thick. In France and Germany, forests of wild pine are frequently raised by sowing the seed where the plants are finally to remain; in which case an acre, where the soil and situation are favourable, will require 14 lb. of seeds with the wings on, and 11 lb. without the wings; and, where the soil and situation are unfavourable, 18 lb. with the wings, and 12 lb. without them. If the seeds are sown in rows, half the quantity will suffice in both cases. The time for sowing, whether in the nursery or in the forest, is from the end of March to the beginning of May; taking the climate of London for one extreme, and that of Aberdeen for the other.

Boutcher, from having observed that the seeds of the Scotch pine are often injured by kilndrying, recommends not gathering the cones in the December of the same year in which they ripen, but deferring this to the March or April following; and then keeping them in a dry place till June, July, or August, sooner or later, according as the weather becomes hot. At this season, they are to be taken out and exposed to the heat of the sun during the day; but put under cover in the evenings, and kept constantly from rain and dew. In a few days the cones will expand, and the seeds will rattle within them, when they can be easily taken out by sifting, &c. They are

then to be kept in bags or boxes in a dry room, till the sowing season in the April following. Boucher recommends sowing the pine seed in shady borders of generous loose mould, about the middle of March; and covering it $\frac{1}{2}$ in. thick, or covering it at first $\frac{1}{2}$ in.; and, just as the seed begins to vegetate, raking off one half of the covering with a short-toothed rake. Many thousands of plants, in stiff grounds and dry seasons, he says, for want of this precaution, are smothered; being unable to struggle with the hard-crusted surface. Baudrillart makes the same remark with reference to the Scotch pine raised in nurseries in France. Boucher's reason for sowing the Scotch pine so early is, that, when the plants are not well rooted before the hot seasons sets in, they become stunted, and are sometimes killed. It will be observed that, by Boucher's plan, a year is lost, but in other respects it seems unexceptionable. When the seeds are kilndried with care, and at a low temperature, they will not be injured; and the labour attending this process must be less than that of removing them at least twice a day, for several weeks, from a shed or loft into the open air, and back again. After the plants come up, if they can be supplied with water for two or three weeks, it will greatly increase their vigour. In the following April, they may be transplanted into nursery lines, 1 ft. 3 in. asunder; and 6 in. or 7 in. apart in the row, where they may remain two years; after which they should be removed to their final destination: or, should large plants be required, they may be removed a second time, and planted in the nursery, in rows 3 ft. asunder, and 1 ft. 6 in. apart in the row; where, after standing two years, they "will transplant with absolute safety, and grow as freely as the younger plants; notwithstanding the general prejudice against old Scotch pines, which has only a good foundation when they have not been transplanted seasonably, or properly cultivated." (*Treatise on Forest Trees, &c.*, p. 136.) The general nursery practice is to allow seedling Scotch pines to remain two years in the seed-bed; after which they are taken up, and planted in rows 1 ft. 2 in. apart, and 3 in. apart in the lines, taking care never to prune the tops, and to injure the roots as little as possible. "If they remain a third year in the seed-bed," says Sang, "they are good for nothing." Scotch pines, the same author observes, "should never stand longer in the lines than one year after planting, unless they are to be planted out in very fine soil; in which case, they may be allowed two years in the lines, but at the distance of 6 in. between plant and plant. Two-year seedling Scotch pines of good growth," he says, "one year planted out on good soil, rise with far better roots in proportion to their tops than when of any other age, and are therefore more fit for general use." (*Plant. Kal.*, p. 319.)

Mr. Farquharson of Marlee, writing to Dr. Hunter in 1755, gives the following account of his mode of raising the Scotch pine from seeds, and planting it out on the Highland mountains. He gathers the cones in February or March, from thriving young trees; and sows the seeds in the end of April or the beginning of May, in light loamy soil, trenched 1 ft. 6 in. deep, and laid out in beds 5 ft. broad. He sows the seeds very thick, and covers them with a "thick sifting of mould," from the alleys. Plants raised in this manner, he says, will rise like a brush. No kind of manure should be given to the beds, as productive of weeds; the drawing of which not only brings up many of the tender plants, but loosens the ground, and makes blanks that let in the frost in winter, and the drought in summer. To give an idea of the sowing, he never considers his crop of plants good unless he has above 1000 in each foot long of the beds, that is, in five square feet, upon their having two seasons' growth. "I plant them out," he says, "irregularly from the seed-bed, about 3 ft. asunder; upon the mountainous ground where they are to rise to perfection. I begin to plant the driest ground in autumn, 18 months after sowing, and persist in this operation until the frost prevents me. I begin again in February, or, rather, as the weather admits, and continue this work sometimes till the end of April, so as to plant out the product of 2-year-old seed-beds. I put the plants into the ground with two cuts of a spade, made in the form of the letter V, thus ; I raise the point of the angle with what we call a dibble, or wooden spa-

tula, with a handle about 1 ft. 6 in. in length; and, laying the plant up to the neck, tread down the raised sod with the foot. In this method, two men may plant 1000 plants in a day. When the ground is rocky, or very stony, I use a dibble shod with iron, having a cleft at the extremity to lead down the root, putting the plants into the ground in the manner that cabbages are planted. One man will plant as many in this way as two in the other; yet the first method is preferable where the ground admits of it, as I have always observed fewer plants to fail by it. My reason for planting direct from the seed-bed, without transplanting in a nursery, is, that it comes nearest to the operation of nature. Plants that have been removed from the seed-bed, and transplanted in the nursery, must necessarily have their roots pruned considerably before they can be planted in pits of the kind above described, which adds greatly to the expense. Besides, nursing causes a luxuriant growth in this hardy mountainous tree, which spoils its nature, and robs it of longevity." (*Hunt. Evol. Syl.*, i. p. 290.)

Culture in Plantations. Little remains to be added to what has been said on this subject in our general introduction to the *Abiétinæ*, p. 2132. The Scotch pine, when planted with a view to the production of timber, should always be in large masses; and when with a view to ornament, in single trees or in small groups. It should never be planted in belts, or in narrow plantations, unless the plants are thinned out, so as to admit of their retaining their branches from the ground upwards; in which case the timber produced will be of little use. When the plantations are made on a surface that is tolerably even and regular, the plants should always be inserted in lines, for the greater convenience of future culture; but when the surface is rocky, steep, and in other respects irregular, the plants can only be put in accordingly. The nice points in the management of Scotch pine plantations are, the thinning and pruning; both of which should be performed very sparingly, where tall clean timber is the object in view. Both operations must be guided, in a great measure, by the quantity of timber which the soil is estimated to produce on a given space.

The Culture of the Scotch Pine in the North of Scotland has been thus detailed to us by Macpherson Grant, Esq. of Ballindalloch, in Inverness-shire, a successful and very extensive planter:—"In the northern counties of Scotland, the *Pinus sylvestris* has for a long time been pretty extensively planted; and, although this is the native locality of the tree, it has been very generally remarked that the artificial are very inferior to the natural woods. Much discussion had arisen, and many theories had been broached, to explain this inferiority, till it was at length suggested that it might very probably be caused by the circumstance of the seed, from which the plants were produced, being collected from unhealthy and stunted trees, in districts more accessible than those in which the tree attains its greatest perfection. Premiums for the greatest quantity of plants grown from seed gathered in the natural forests have for some years been offered by the Highland and Agricultural Society of Scotland; and have been awarded to Mr. Grigor, nurseryman at Elgin, who has taken great pains to further this object, and who last year likewise obtained a premium for the best *Report on the Natural Forests of Scotland*. (See p. 2165.) Until within the last 20 years, plantations, in this part of the country, were formed of Scotch pine alone; but it is now usual to mix them with larch in nearly equal proportions; and here we plant about two larches to one pine. The Scotch pines are procured from the nurserymen two-years-old seedlings; and they are placed at once on the hilly ground, where they are finally to remain. A workman, with a common spade, makes a double cut at right angles, like the letter T, thus T; raising the turf slightly with the spade, so as to admit the insertion of the plant at the point where the two cuts meet: a woman or boy follows with the plants; and, having placed one in the opening, compresses the turf by stamping on it with the foot. In this manner, a man and boy will plant about 1000 in a winter day (six hours). The number of plants is about 5000 to the imperial acre. The larches are of the same

age, and are planted in the same way, as the pines. The seasons of planting are autumn and spring; but the former is preferred, from the uncertainty of getting the work accomplished in spring, on account of snow and frost. The men are paid 1s., and the women and boys 6d., per day, of six hours. The Scotch pine plants of the true kind (from Highland seed) cost 2s. per thousand of 1200, and the two-years' seedling larches 3s. per thousand. To these expenses must be added that of fencing, which varies according to the situation of the plantation. If near farms, stone walls or turf dikes faced with stone are required; if further removed from the approaches of cattle, turf fences are sufficient; whilst in the most remote parts, where occasional inroads from sheep are alone to be apprehended, fences are sometimes dispensed with, and a person resident on the spot is employed, at a small salary, (say 5*l.* per annum) to protect the plantation by driving away any sheep or cattle that may encroach on it. A healthy plantation should be safe from injury from sheep in 8 years, and in 12 years from cattle. In wet portions of the hilly ground, narrow surface drains are of great advantage, and may be made at a small expense.

"In the natural forests of Scotch pine, the plants spring up of different ages; and, being consequently of various sizes, the stronger gradually destroy the weaker, until the wood is reduced to the distances at which the trees can ultimately stand; whilst the lateral branches gradually decay and fall off, so that thinning and pruning are quite unnecessary. In short, a natural, or self-sown, forest of Scotch fir is left entirely to nature. Nature sows the seed, rears the tree, prunes and thins the wood; and the hand of man is applied only to cut it down when fit for timber. In this manner, the extensive forests of Glenfeshie, Rothiemurchus, Dulnain, Glenmore, and Abernethy, on the Spey, and those of Braemar and Invercauld on the Dee, were produced. The high price of timber during the war induced the proprietors of those fine woods to cut them down. Most of them are now exhausted; and the few trees which remain of the others scarcely suffice to convey an idea of those that are gone. For several years, 18,000*l.* per annum was produced from the Rothiemurchus wood, after deducting all expenses of felling, sawing, and floating to the mouth of the Spey; and a sum not less than 250,000*l.* has probably been obtained from that forest alone. The ground which has been cleared is rapidly regaining its covering of wood: wherever the heath is short, and especially where the surface is broken so as readily to admit the seed, thousands of plants spring up; nor do I know a more interesting sight, than this gradual progress of nature to repair the destruction caused by the hand of man.—*Macpherson Grant. Ballindalloch, August 26. 1837.*"

Thinning and Pruning, as at present practised in the Scotch Pine Plantations in the North of Scotland. After perusing Mr. Grigor's Report on the native pine forests of Scotland, of which an abstract is given in p. 2165., we wrote to him for information on the subjects of thinning and pruning, as actually practised in these forests, and also in artificial plantations; and as to the effects of the neglect of either or both of these operations. To our application Mr. Grigor kindly and promptly sent us the following answer:—"The old trees of the native Scotch pine forests have trunks quite clean and free from old stumps, so that the side branches must have rotted off when the trees were young, and of a small size. Some of the pines, grown on exposed situations, have strong side branches, but not very near the ground: such branches are commonly found above large clean trunks of from 15 ft. to 30 ft. in length. When the timber of these forests is cut up, loose knots are rarely met with: indeed, knots of any importance are seldom seen, except where such were attached to live branches at the time the trees were felled. The wood of the old trees appears so clean and equal when sawn up, that, in many, only very slight marks of lateral branches are visible. The young trees, of from 25 to 40 years' growth, present regular tiers of decayed branches near the ground, which fall away in course of time. The proprietors of the native forests sometimes prune and thin the woods, but not often: they thin when the

trees are much crowded, and of nearly an equal size, especially when situated near a road or river, where timber is of most value; but this is not attended to in the more remote parts of the forests. I have only seen the trees pruned when they stand quite thin, or, from having lost their leading shoots, by sheep pasturing the ground, or other casualty, have become bushy. In this case, I have seen a considerable extent gone over in January and February, and pruned to the height of from 2 ft. to 4 ft. with the axe; the whole height of the trees being from 5 ft. to 10 ft. In the Highland natural forests, the young plants do not often rise of equal strength and size. There is commonly a portion of them (a sufficient crop) stout enough to overtop the smaller ones; and the latter are of much benefit in preventing the side branches of the former from advancing to a large size. The side branches of the true Highland pine naturally take a wide or horizontal direction, whereby they are more subject to decay by the closeness of the trees, than if they inclined to a more perpendicular figure, as do our Low Country pines. In planted woods, the pine trees are commonly of the same size and age; and then it is absolutely necessary to thin them, as their tops rise equal, and form a surface parallel to that of the ground on which they stand; therefore, without relief by thinning, the whole are, to a certain extent, injured; whereas, in natural forests, the difference of sizes and ages is great, and the strongest prevail unharmed. I am acquainted with many artificial plantations of pine; and the common method is, to thin the trees gradually as they get too close or too high for their girth. Planted pines are not commonly pruned, that being considered the worst mode of treatment. Many proprietors, of late, have given over thinning; but the woods are much hurt by being too much confined. A good tree can scarcely be seen, except near the outside, or where a road opens up and admits air. I am clearly of opinion that we shall not have good pine plantations until they are produced from the seeds of the native Highland forests, which are more healthy and permanent than the kind commonly cultivated. — *John Grigor. Forres, Sept. 9. 1837.*"

The Earl of Aberdeen; Macpherson Grant, Esq., of Ballindalloch; Mr. George Saunders, gardener and forester to the Duke of Richmond at Gordon Castle; Mr. Roy, nurseryman, Aberdeen; and other proprietors and gardeners of the north, have sent us answers to all our queries on the subject of thinning and pruning, which correspond with those given above by Mr. Grigor. From the Earl of Aberdeen's letter, we give the following extract: — "I received your letter during an excursion in the upper part of this county, precisely in the neighbourhood of those natural fir forests respecting which you had written to me. From the information I have received, I think I may venture to assure you that these forests are never thinned, at least with the view of promoting the growth of the trees; nor, in fact, with the exception, perhaps, of draining to a limited extent, in particular situations, does there appear to be any care taken, or any management whatever to exist. This, indeed, is sufficiently obvious from the very appearance of the forest; on large portions of which the trees are thinly scattered, and at considerable intervals; in other parts, they are crowded together, and stand more densely than they could ever have been placed by the hand of the planter. This appearance, however, is not so much the consequence of neglect, as the result of an opinion that it is best not to meddle with the trees at all. They are left to thin themselves, as it is called, by which the weak plants are overpowered, and destroyed by the stronger. I have also been assured that, in cases where the most judicious thinning has been attempted, the admission of the wind has proved much more injurious to the remaining trees, than is experienced in young woods of the planted fir under similar treatment. I imagine that the finest fir forests now existing in Scotland are those to which I have referred, in the upper part of the valley of the Dee, and in the district of Braemar. Many of the trees are of great size and beauty. I have seen none, however, at all to compare with a tree cut in the Duke of Gordon's forest of Gleannmore, and of which a plank is preserved at Gordon Castle, measuring 5 ft. 8 in. in diameter, of perfectly

sound wood (see p. 2161.). This, I presume, is by far the largest specimen of *P. sylvestris* on record; at least, I have never seen or heard of any at all like it.—*Aberdeen. Haddo House, September 4. 1837.*"

Thinning and pruning in England. We have already noticed (p. 2134.) the practice of Mr. Salmon and Mr. Pontey in England, both strong advocates for thinning and pruning. On applying to the Duke of Bedford, to know the results of the practice carried on under the direction of these arboriculturists in the woods at Woburn, His Grace's forester, Mr. Ireland, informs us that Mr. Salmon, by cutting off large branches rather carried the practice too far; but that the trees pruned under the direction of Mr. Pontey, about the years 1802 and 1803, were not in the slightest degree injured, as only a few of the smaller branches were taken off. On examining the timber of such trees as were cut down, Mr. Ireland found the places where the branches had been cut off quite sound, with new wood formed over them; but this new wood, though closely covering the part cut off, yet did not incorporate itself with it. On the other hand, he found the timber of some trees, where the branches had died off naturally, in which the wood was unsound, though the wound formed by the decayed branches was closely covered over with new and sound wood; thus, as Mr. Ireland remarks, showing the advantage of cutting off the branches close to the bole when they are quite small, and before they begin to decay. His Grace the Duke of Bedford, after informing us that Mr. Ireland's statement as to the effect of pruning the Scotch pine is correct, adds: "From pruning to thinning, the transition is obvious and natural; and I must confess myself a decided advocate of bold but judicious thinning, in opposition to the practice of the Duke of Portland, at Welbeck. Perhaps I may inherit this from my grandfather, John Duke of Bedford, who was, even in those early days, a decided friend to thinning plantations when young. I will state an anecdote on this subject, which is much at your service, and may possibly amuse the readers of your *Arboretum*. In the year 1743, my grandfather planted the large plantation in Woburn Park, now known by the name of the 'Evergreens' (to commemorate the birth of his daughter, afterwards Caroline Duchess of Marlborough); being something more than 100 acres, and having been before that time a rabbit warren, without a single tree upon it. In the course of a few years, the duke perceived that the plantation required thinning, in order to admit a free circulation of air, and give health and vigour to the young trees. He accordingly gave instructions to his gardener, and directed him as to the mode and extent of the thinning required. The gardener paused and hesitated, and at length said: 'Your Grace must pardon me if I humbly remonstrate against your orders, but I cannot possibly do what you desire: it would at once destroy the young plantation; and, moreover, it would be seriously injurious to my reputation as a planter.' My grandfather, who was of an impetuous and decided character, but always just, instantly replied: 'Do as I desire you, and I will take care of your reputation.' The plantation, which ran for nearly a mile along the road leading from the market town of Woburn to that of Ampthill, was consequently thinned according to the instructions of the duke, who caused a board to be fixed in the plantation, facing the wood, on which was inscribed, 'This plantation has been thinned by John Duke of Bedford, contrary to the advice and opinion of his gardener.'—*Bedford. The Downe of Rothiemurchus, September 2. 1837.*"

Felling. The age at which the Scotch pine should be felled depends on the degree of perfection which the tree will attain in the particular locality. On thin poor soils, where the trees are planted thick, it may be most profitable to cut the whole plantation down, like a crop of corn, as Mr. Main recommends (p. 2132.), at 20 or 30 years' growth; while, on deeper and more substantial soils, the trees will gain in dimensions for double or treble that number of years; and they ought to be left accordingly.

Accidents, Diseases, &c. We are not aware of the Scotch pine being more liable to accidents, diseases, or insects, than any other species of *Abietinæ*, or that it has any which are peculiar to it. Mathews states that the red-

wooded Scotch pine, when come to some age, is, in wet ground, attacked by the rot; which commences in the collar, and spreads to the adjacent roots and up the stem, in a manner very similar to the rot in the larch. The red wood approaches nearer to the outside of the trunk, in trees where the rot exists, than in others, and is nearest that side of the tree where the rot is the greatest. This disease is found in trees growing in poor wet tills, and in flat, sandy, moorish soils, with a retentive subsoil. "The fact that the red pine in Scotland has fewer sap wood layers than the red pine of Memel or of North America, and also the fact that, in most situations in Scotland, the red pine soon decays, and soonest in the places where the trees have fewest sap wood layers, and where the timber has been planted, that is, where the cones have been kilndried, are worthy of notice. Scotch red pine has generally from 14 to 40 layers; Memel, from 40 to 50; Canadian, often 100. We consider the long, moist, open winter, and cold ungenial spring in Scotland, and the till bottoms soaking with water, perhaps aided by the transplanting, and the kilndrying of the cones, to be the causes of this early loss of vitality or change of sap wood into matured wood. In Poland and Prussia, the earth does not remain so long cold and moist as in Scotland, but is either frozen, or sufficiently warm and dry: this occurs even to a greater degree in Canada; and neither the Memel nor Canadian trees have any chance of being planted, or the seeds kilndried." (*On Naval Timber*, p. 75.) In mountainous countries, and in countries subject to heavy falls of snow, the Scotch pine is liable to the accidents which we have mentioned (p. 2136.) as common to the order generally; and not only forests take fire, but also single trees. A remarkable instance of this last kind of accident is noticed by Dr. Howison, who visited the north of Russia in 1818; and who, having observed many large trees of the *Pinus sylvestris* standing erect in the forest, in a withered, and frequently in a dead state, was led to examine into the reason. He was not a little surprised to find that, in many cases, although the bark was entire, the interior part or wood of the tree was in a great measure charred. On enquiry, he found that this was occasioned by the travelling boors, in the sultry dry weather of summer, seeking the shade of large trees, and making fires for dressing their victuals about the roots of the trees. Many of these roots lie near the surface; and, as they abound very much with resinous matter, they readily catch fire. The fire seems to be propagated slowly, as in match paper; a gradual and stifled combustion creeps onwards, encouraged by the drought, and constantly fed by the empyreumatic oil of turpentine (or tar), which is produced by the heat, until the interior of the trunk itself be destroyed. (*Jameson's Journal*, iv. p. 207.)— We have given these ample details on the subject of the Scotch pine, considering it by far the most valuable timber tree of the genus in Britain, and even in Europe.

Statistics. Recorded Trees. Gilpin mentions Basilsleigh, in Berkshire, as containing some of the most picturesque species of the Scotch pine in England in his time. He also mentions some fine trees at Thirkley, near Thirk, in Yorkshire, a few of which still exist. In Scotland, at Inverary, a tree mentioned in the *Argyllshire Report* has a trunk 10 ft. in circumference at 4 ft. from the ground; one at Castle Huntley, in Perthshire, measured in 1796, was 13 ft. 6 in. in circumference at 3 ft. from the ground; and, close by the ground, 19 ft. in circumference. This tree was considered at the time the largest in the county. At Cameron, in Dumbartonshire, on the shores of Loch Lomond, a tree, in 1784, measured 7 ft. 2 in. in circumference at 4 ft. from the ground; one at Bargally, in 1780, measured 9 ft. 3 in. in circumference, and 90 ft. high, with 22 ft. of clear stem. It was planted in 1697, and, consequently, was nearly 100 years old. According to Dr. Walker, in the year 1740, the late Sir J. Nasmyth, formed at New Posso, in Tweeddale, a very extensive Scotch pine plantation on the north side of a barren hill of considerable height. In the year 1791, many of the trees in the plantation measured 4 ft. in girth, and contained from 4 in. to 6 in. of red wood. In Ireland, in 1794, Hayes mentions some Scotch pines, at Ballybeg and at Hillbrook, which measured 7 ft. in girth at 5 ft. from the ground, and 5 ft. at 50 ft. high. One felled in its 70th year was 77½ ft. in length of clear timber, and measured 6½ ft. in girth at 50 ft. from the ground. (*Pract. Treat.*, &c. p. 118.) At Biny Park, Sir S. Smyth, Bart., was one 10 ft. round, containing nearly the same bulk for 25 ft. At Luttrellstown, Earl of Carhampton, one of 85 years' growth from the seed was 11 ft. in girth; and another, of very great height, was 11 ft. 10 in., or nearly 4 ft. in diameter, which Hayes believed to exceed the dimensions of the largest foreign deal ever imported. These trees stood among oaks and other trees, on very high ground, though flat at top for a considerable extent, and much exposed. At Emo Park, Earl of Portarlington, were several Scotch pines, with trunks from 8 ft. to 9 ft. in girth, clear to the height of 20 ft. or 30 ft., and large wild branching heads, richly clothed with leaves. (*Ibid.*)

Existing Trees. In the Environs of London. At Muswell Hill, it is 60 ft. high; at Ham House, near Richmond, it is 70 ft. high, the diameter of the trunk 4 ft., and of the head 26 ft.; at Whitton there are many specimens, 100 years planted, from 70 ft. to 80 ft. high, with trunks from 2 ft. to 3 ft. in

diameter. — South of London, in Cornwall, at Port Elliott, 70 years planted, it is 45 ft. high; at Carclew, it is 69 ft. high, the diameter of the trunk 3 ft. 3 in., and of the head 40 ft.; another specimen has a trunk 4 ft. in diameter. In Devonshire, at Killerton, it is 59 ft. high, the diameter of the trunk 3 ft. 9 in., and of the head 77 ft.; the trunk is clear, and nearly the same in diameter to the height of 35 ft.; at Bystock Park, 21 years planted, it is 50 ft. high; at Endeleigh Cottage, 22 years planted, it is 60 ft. high. In Dorsetshire, at Melbury Park, 100 years old, it is 76 ft. high, with a trunk 3 ft. in diameter. In Hampshire, at Alresford, 81 years planted, it is 63 ft. high. In Somersetshire, at Brockley Hall, it is 60 ft. high, with a trunk 3 ft. in diameter; at Kingweston, it is 90 ft. high, with a trunk 3 ft. 4 in. in diameter. In Surrey, at Bagshot Park, 80 years planted, it is 75 ft. high; at Clarendon, it is 90 ft. high, the diameter of the trunk 4 ft. 6 in., and of the head 40 ft.; at Ashley Park it is 70 ft. high, with a trunk 4 ft. 6 in. in diameter; at Deepdene, 8 years planted, it is 53 ft. high. In Sussex, at Woudan, 70 years planted, it is 45 ft. high; at Kidbrooke, 60 years planted, it is 80 ft. high, the diameter of the trunk 4 ft., and of the head 30 ft. In Wiltshire, at Warour Castle, 50 years planted, it is 60 ft. high; at Longford Castle, it is 60 ft. high, with a trunk 2 ft. 3 in. in diameter. — North of London. In Bedfordshire, at Woburn Abbey, it is 75 ft. high, the diameter of the trunk 3 ft. 6 in., and of the head 40 ft.; at Southill, it is 50 ft. high, with a trunk 2 ft. 6 in. in diameter. In Berkshire, at Bear Wood, 14 years planted, it is 40 ft. high. In Buckinghamshire, at Harlington, 160 years old, it is 70 ft. high, the diameter of the trunk 5 ft., and of the head 48 ft., the trunk being clear to the height of 40 ft. This tree has been supposed to be the largest of the species in the kingdom, and several sketches of it have been taken, but, as will be seen, it is exceeded by several trees in height, and by some others in bulk. Here are 5 other very fine pines, with trunks 12 ft. in circumference. In Cambridgeshire, at Gamlingay, it is 80 ft. high, with a trunk 4 ft. in diameter. In Caermarthenshire, at Golden Grove, it is 97 ft. high, the diameter of the trunk 3 ft. 6 in., and of the head 30 ft. In Denbighshire, at Llanbede Hall, 70 years planted, it is 65 ft. high. In Leicestershire, at Melbourne Hall, it is 81 ft. high, diameter of the trunk 5 ft., and of the head 56 ft., another near it is 78 ft. high, diameter of the trunk, 4 ft. 2 in., and of the head 47 ft. 6 in. These are remarkably fine trees. In Durham, at Stanwick Park, is one with a trunk 3 ft. in diameter. In Essex, at Audley End, 60 years planted, it is 45 ft. high, the diameter of the trunk 2 ft. 6 in., and of the head 57 ft. In Herefordshire, at Hatfield, 106 years old, it is 100 ft. high, the diameter of the trunk 3 ft., and of the head 29 ft. In Hertfordshire, at Brockett Hall, it is 50 ft. high, with a trunk 3 ft. in diameter. In Monmouthshire, at Trodegar Park, 110 years old, it is 70 ft. high, the diameter of the trunk 3 ft. 6 in., and of the head 52 ft.; another, of the same age, is 85 ft. high, the diameter of the trunk 3 ft., and of the head 50 ft. In Norfolk, at Merton Hall, it is 86 ft. high, with a trunk 3 ft. in diameter. In Radnorshire, at Maeslugh Castle, it is 45 ft. high, with a trunk 2 ft. in diameter. In Suffolk, at Finborough Hall, 60 years planted, it is 100 ft. high, the diameter of the trunk 3 ft., and of the head 30 ft.; and at Snettton Parsonage, is one 90 ft. high, with a trunk 3 ft. 4 in. in diameter. In Warwickshire, at Combe Abbey, 100 years planted, it is 70 ft. high, the diameter of the trunk 3 ft. 9 in., and of the head 50 ft. In Worcestershire, at Hagley, is one with a trunk 3 ft. 2 in. in diameter; at Haxdor House, 13 years planted, it is 22 ft. high; at Croome, 65 years planted, it is 70 ft. high, the diameter of the trunk 3 ft., and of the head 60 ft. In Yorkshire, at Castle Howard, it is 120 ft. high, the diameter of the trunk 3 ft., and with a bole 100 ft. in length; at Studley, one is 99 ft. high, with a trunk 3 ft. 5 in. in diameter; and another is 82 ft. 6 in. high, diameter of the trunk 3 ft. 3 in., and of the head 51 ft. (See fig. 2050, in p. 2163.)

Pinus sylvestris in Scotland. In the Environs of Edinburgh. At Dalmeny Park, it is 60 ft. high, the diameter of the trunk 3 ft., and of the head 36 ft. — South of Edinburgh. In Ayrshire, at Dalquharron, it is 70 ft. high, the diameter of the trunk 2 ft. 9 in.; another, 37 years planted, is 45 ft. high; at Kilkerran, 130 years old, it is 70 ft. high, the diameter of the trunk 3 ft.; at Newark, it is 60 ft. high, with a trunk 3 ft. 9 in. in diameter. In Haddingtonshire, at Tynninghame, 110 years old, it is 40 ft. high, the diameter of the trunk 5 ft. 4 in., and of the head 45 ft. — North of Edinburgh. In Aberdeenshire, at Thainston, it is 55 ft. high, with a trunk 8 in. in diameter; in Glen Dee, in the group fig. 2035. (to a scale of 50 ft. to 1 in.) it is 75 ft. high. In Banffshire, at Gordon Castle, it is 90 ft. high, the diameter of the trunk 3 ft. 6 in., and of the head 60 ft. In Forfarshire, at Kinnaird Castle, 150 years old, it is 75 ft. high, the diameter of the trunk 3 ft. 6 in. In Inverness-shire, at Coul, 40 years planted, it is 50 ft. high, the diameter of the trunk 2 ft. 6 in., and of the head 30 ft. In Perthshire, at Lawers, it is 60 ft. high, the diameter of the trunk 3 ft. 4 in., and of the head 57 ft.; at Dupplin, it is 59 ft. high, the diameter of the trunk 3 ft. 6 in.; at Gleneagles (the Braemar fir), it is 50 ft. high, with a trunk 3 ft. 6 in. in diameter; at Thymouth, it is 60 ft. high, with a trunk 4 ft. in diameter; another, 90 years planted, is 69 ft. high, the diameter of the trunk 4 ft., and of the head 56 ft. In Sutherlandshire, at Ardrais, it is 50 ft. high, the diameter of the trunk 2 ft. 9 in., and of the head 25 ft.; at Kilkalkmill, it is 68 ft. high, the diameter of the trunk 2 ft. 3 in., and of the head 31 ft. In Stirlingshire, at Blair Drummond, 75 years planted, it is 50 ft. high, the diameter of the trunk 3 ft., and of the head 40 ft.; at Airthrey, Tullibody, and Blairlogie, are specimens above 60 ft. high, with trunks 2 ft. 6 in. in diameter; at Callendar Park, it is 60 ft. high, the diameter of the trunk 4 ft., and of the head 80 ft.; in Bannockburn Wood, it is 74 ft. high; and at Dunmore (see fig. 2056, to a scale of 50 ft. to 1 in.), 67 ft. high.



2055

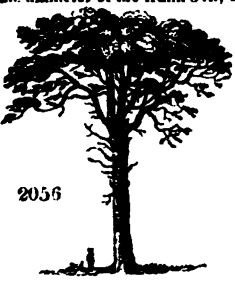

2056

Pinus sylvestris in Ireland. Near Dublin, at Cypress Grove, it is 75 ft. high, the diameter of the trunk 3 ft. 6 in., and of the head 50 ft. In King's County, at Charleville Forest, 45 years planted, it is 76 ft. high, diameter of the trunk 5 ft. In Fermanagh, at Florence Court, it is 90 ft. high, the diameter of the trunk 3 ft. 6 in.; at Castle Coole, it is 85 ft. high, the diameter of the trunk 3 ft. 6 in. In Sligo, at Makree Castle, it is 71 ft. high. In Kilkenny, at Mt. Juliet, it is 73 ft. high. In Tipperary, at the seat of — Walls, Esq., near Carrick on Suir, there is a Scotch pine with a trunk 50 ft. in height, clear of branches, and a circumference of 15 ft. the whole tree is 84 ft. high. The Scotch pine at this place grows spontaneously from seed shed by the old trees; and the timber, which is supposed equal to that of Norway, sells on the spot at 3s. 8d. per cubic foot.

Pinus sylvestris in France. Near Paris, at Verrières, 20 years planted, it is 32 ft. high; and a pyramidal variety, of the same age, is 18 ft. high. In Brittany, at Barres, 12 years planted, it is 14 ft. high. At Colomby, near Metz, 70 years planted, it is 99 ft. high, the diameter of the trunk 2 ft. 6 in. In the Botanic Garden at Avranches, 40 years planted, it is 40 ft. high. In the Park of Clervaux, near Chât Meraut, 33 years planted, it is 69 ft. high.

Pinus sylvestris in other Countries. In Bavaria, in the Botanic Garden at Munich, 24 years planted, it is 24 ft. high. In Austria, near Vienna, at Brück on the Leytha, 60 years planted, it is 90 ft. high. In Sweden, in the Botanic Garden at Lund, it is 54 ft. high. In Russia, near St. Petersburg, on the small island of Soanovy Roshá, it is 77 ft. high, the diameter of the trunk 2 ft., and of the head 16 ft. In Italy, at Monza, 65 years planted, it is 60 ft. high.

Commercial Statistics. In the London nurseries, one year's seedling plants of the common variety are 1s. 6d. a thousand; two years' seedlings, 3s. 6d. a thousand; plants one year transplanted, 10s. a thousand; and two years transplanted, 20s. a thousand. At Bollwyller, single plants transplanted are 3 cents each; and at New York, 50 cents. Plants of the Highland red pine are, in London, 1s. 9d. a thousand; and at Grigor's Nursery, Forbes, N. B., 1s. 6d. a thousand; and of the pin de Hagueneau, at Bollwyller, 8 cents each. Seeds of the common Scotch pine are, in London, 2s. per lb.; of the Highland pine, 2s. 6d. per lb.; and seeds of the pin de Hagueneau, at Bollwyller, are 1 franc 50 cents per lb.

♣ † 2. *P. (s.) PUMILIO* Hænke. The dwarf, or Mountain, Pine.

Identification. Hænke Beob., 68; Willd. Sp. Pl., 4. p. 495; Lamb. Pin., ed. 2, 1. t. 2; Cam. Hort., 127; Cus. Pan., 15; Hall. Helv., No. 1668. 7; Alt. Hort. Kew., ed. 2, 5. p. 314; Lodd. Cat., ed. 1836; Baum. Cat., ed. 1835.

Synonymes. *P. sylvestris montana* 7 *Alt. Hort. Kew.*, ed. 1, 3. p. 366; *P. s. humilis* 7 *Nees. Cat. Hort. Blackb.*, 50; *P. conis erectis* *Tourn. Inst.* 586; *Scheuchz. It.*, 460, *Du Ham. Arb.*, 2. p. 126; *P. humilis*, &c., *Tourn. Inst.*, 586; *P. suedeticus* seu *carpathicus* *Ungarisch Mag.*, Ster. bande, 58; *Pinaster obsis erectis* *Boiss. Pin.*, 498; *P. tatarica* *Müll. in Herb. Boiss.*; *P. p. montanus* *Park.*, 1537. f. 8; *P. quatuor austracus* *Cus. Hist.*, 1. p. 32; Pin nain, Fr.; Krumholz, *Ger. Engraving.* Lamb. Pin., ed. 2, 1. t. 2; our fig. 2061., to our usual scale, and fig. 2057. and 2058. of the natural size.

Spec. Char., &c. Branches generally recumbent. Leaves short, stiff, somewhat twisted; thickly distributed over the branches, with long, lacerated,



2057

woolly, white sheaths. Cones, when young, erect; when mature, pointing outwards. Buds (fig. 2057.) ovate, blunt, resinous. Leaves (fig. 2058.) from 2 in. to 2½ in. long; sheaths, at first, from ½ in. to 1½ in. long, white and lacerated; afterwards falling off or shrinking to ¼ in. or ½ in. long, and becoming dark brown or black. Cones (d) from 1½ in. to 2 in. long, and from ¾ in. to 1 in. broad; reddish or dark purplish brown when young, and of a dull brown when mature. Scales (b) and seeds (a) resembling those of *P. sylvestris*, but smaller. Cotyledons 5 to 7. A large spreading bush, or low tree; a native of Europe, on mountains. Introduced in 1779; flowering and ripening its cones at the same time as the Scotch pine. Fig. 2063. in p. 2190. is a portrait of a bush at Dropmore, which, in 1837, was 12 ft. high and 25 ft. in diameter.

2058

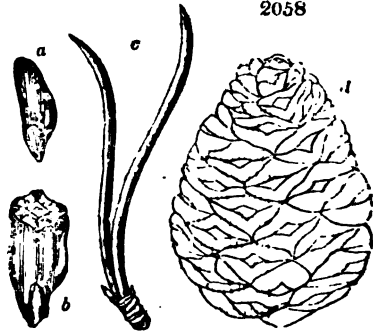

Varieties.

- ♣ † *P. (s.) p. 2 rubraeflora* has red flowers, but does not differ in any other respect from *P. (s.) pumilio*. There is a bush of it at Dropmore above 12 ft. high, and covering a space 21 ft. in diameter.
- ♣ † *P. (s.) p. 3 Fischeri* *Booth, Lodd. Cat.*, ed. 1836, *Lawson's Man.*, p. 333. — Only small grafted plants of this variety are in the country, it not having been introduced till about 1832. In the shoots and foliage, it bears so strong a resemblance to *P. (s.) pumilio*, that we doubt very much if it even merits to be considered as a variety of

that species; nevertheless we give it as such, till it shall be farther known. In the Horticultural Society's Garden, it was, in August, 1837, 4 ft. 6 in. high, and produced two cones, which, however, did not arrive at maturity. The scales were not hooked, and they did not appear to differ from those of *P. (s.) pumilio*. Mr. Booth states that he raised *P. (s.) p. Fischeri* in 1825-6, from seeds received from M. Kin of Philadelphia; from which it might be presumed that it was something quite distinct from any European species or variety. Plants, in the Floetbeck Nurseries, are 10s. 6d. each.

■ † *P. (s.) p. 4 Mughus*; *P. s. Mugho* Matt. Camer; *P. montana* Bawn. *Cat.*; *P. Mugho* Jacq., Poir, and N. Du Ham., v. p. 233. t. 68.; *P. echinata Hort.*; *P. uncinata* Dec., *Lod. Cat.*, ed. 1836; and our *figs.* 2059. and 2060.; the latter showing the cone, seed, scale, and sheath of leaves, of the natural size. The Mugho wild Pine; Pin Mugho, Torchepin, Pin suffis, Pin crin, Pin du Briançonnais, Pin de Montagne, *Fr.*; Bergfichte, *Ger.* — This variety is included by Aiton and others in the preceding one; but, having seen both sorts bearing cones, we are satisfied that they are distinct, though they bear so close a resemblance to each other in foliage and habit, that, when the cones are absent, they might be supposed to be identical. It is remarked in the *Nouveau Du Hamel*, that all the published figures of this variety are bad, with the exception of the one given in that work, from which ours is copied. On comparing *figs.* 2058. and 2060., it will be found that the cones of *P. (s.) p. Mughus*, independently of the peculiar protuberant appearance of the scales, are larger than those of *P. (s.) pumilio*. This and other differences in the cones are quite sufficient, in a technical point of view to constitute *P. (s.) p. Mughus* and *P. (s.) pumilio* distinct species; but, notwithstanding this, they bear such obvious marks of belonging to *P. sylvestris* in their foliage, habit, and locality, that we cannot for a moment hesitate about uniting them to that species.

The only plants which we feel quite certain are the *P. Mugho* of the *Nouveau Du Hamel* are at Syon, at Dropmore, and in the Horticultural Society's Garden, because the cones on the plants in all these places exactly resemble that in our *fig.* 2060., which, as before stated, is copied from the *Nouveau Du Hamel*. *Fig.* 2061. is a portrait of the tree, or rather bush, at Dropmore,



to a scale of 8 ft. to 1 in.; and which was, in 1837, 14 ft. high. This variety is described, in the *Nouv. Des Hamel*, as having the leaves rigid, and of a deep green; the cone conical, often two together, shorter than the leaves, with their scales ending in a pyramidal quadrangular point, which is turned back. The catkins of the male flowers are almost sessile, and the anthers have a round membranaceous crest. It forms a bush in some cases, and a tree in others, according to the soil and situation in which it springs up or is planted.



The cones readily distinguish it from *P. (s.) pumilio*. It is found on the Carniolan Mountains, the Pyrenees, on Mount Ventoux, and in other places. M. Villars observes that, when it grows on the summits of mountains, it is a mere bush; but that, as it descends to the plains, it becomes a tree.

The *P. s. uncinata* of Captain S. E. Cook (*Sketches*, ii. p. 230.), we believe, judging from the young plants in the Horticultural Society's Garden, and from cones sent to Captain Cook from M. P. Boileau, through M. Vilmorin, to be either identical with, or a subvariety of, *P. (s.) Mughus*. The following note has been sent to us by Captain Cook:—" *P. uncinata* is found on the upper zone, or line, of the forest vegetation of the Pyrenees, on both sides the chain. At the Lac de Gaube, and in a few other localities where the forests have been allowed to attain their natural state, it is mixed, at first, with *Picea pectinata* and *Pinus sylvestris*; but, as you ascend, it gradually leaves these species below, and occupies exclusively the Siberian region of the high or central Pyrenees. Other localities in which it is believed to occur are, on some elevated detached masses of mountain between the Pyrenees and the Alps of Mount Cenis, where, no doubt, it lies over the great forests of the Maurienne, which are of *P. sylvestris*. This pine is extremely valuable from its hardiness, as well as for the resinous quality and great durability of its timber. In the Spanish provinces, it is used for torches; and its timber is considered to be superior in quality to that of the *P. sylvestris*; it is also used for making charcoal. As an ornamental tree, it will be highly desirable, from the intensely dark green of its foliage, as well as the close and solid mass it forms, and the habit of the tree, where left at liberty to throw out massy arms, trailing on the ground, a quality so unusual in its class. There are now very scanty remains of this noble tree in the French Pyrenees, where they have been almost wholly eradicated by the barbarous improvidence of the people: there are a few left at the Lac de Gaube, at Gavarnie, at the Lac d'Oo, and on the Arriège; but in Aragon and Catalonia there are forests still remaining of vast extent. They extend from the region of Mont Perdu and the Maledetta, to the Valley of Andorre on the Sègre; the most considerable forests being those opposite to the Valley of Arreau, within the Spanish territory, those to the north-east of Bénarque, and those of the republic of Andorre. It must be grouped with *P. sylvestris*, to which it is nearly related; but the port, colour, and strength of the leaves, and the

form of the cones, enable the practised eye to distinguish it in a moment from that species. — *S. E. Cook. Carlton, near Darlington, May, 1837.*"

- † *P. (s.) p. 5 M. nana*, the Knee Pine of the Styrian Alps, never grows above 3 ft. high. A plant has been in the Trinity College Botanic Garden, Dublin, since 1817; and, in 20 years, it has not attained a greater height than an ordinary-sized man's knee.

Other Varieties. *P. (s.) pumilio* and *P. (s.) p. Mughus* vary so much according to the localities in which they are found, that, if it were desirable to increase the number of subvarieties, there might be a dwarf, a tall, and a medium form given to each. In the Horticultural Society's Garden, there is a handsome, erect-growing, small tree of *P. (s.) p. Mughus*, under the name of *P. uncinata*, and also a dwarf plant, under the same name; both producing hooked cones. At White Knights, where there are 20 or 30 plants of *P. (s.) pumilio*, they vary in size from a recumbent bush, 5 ft. or 6 ft. high, and 20 ft. or 30 ft. in diameter, to trees of between 30 ft. and 40 ft. in height; some of them with trunks clear of branches to 3 ft. or 4 ft. from the ground. Some of these trees have been drawn up in this form in consequence of being crowded among others.

Description, &c. The common character belonging to all the varieties of *P. (s.) pumilio* is, that of being smaller in all their parts, and less glaucous in the general appearance of their foliage, than *P. sylvestris*. The leaves are also much more thickly set on the branches; and the sheaths on the leaves of the current year are much longer and whiter, especially towards the extremities of the shoots. In the dwarf varieties, the cones are small; and those of *P. (s.) p. Mughus* have often a deformed stunted appearance; but, in some of the tall varieties of *P. (s.) pumilio*, the cones are exactly like those of the Scotch pine, as are also the buds. The rate of growth is slow in all the varieties, in the tallest not exceeding 4 in. or 5 in., or at most 6 in., in the year. All the varieties are natives of the mountains of most parts of Europe, more especially in France and Germany; and they have been recognised by botanists from the time of Mathiolus. *P. (s.) pumilio* appears to have been first cultivated in England in 1779, by John Blackburn, Esq., at Orford Hall, near Warrington, in Lancashire, where the original plant still exists, forming a large recumbent bush, but in a shattered condition. All the varieties have a powerful terbinthinate odour; and produce abundantly, when the branches are broken, a fragrant and fluid resin, which is sold, in Hungary, Carniola, &c., as a balsam for curing ulcers, contusions, and rheumatism. The krumholz oil, which is produced by distillation from the burned branches, is of a golden colour, agreeable odour, and acrid oily flavour; and it is used for similar diseases, particularly in veterinary surgery. In Britain, *P. (s.) pumilio* and its varieties are curious or ornamental bushes or trees, and, as such, are valuable objects in small gardens, and in miniature pinetums. The vigour of the foliage, and the intensity of its colour, vary exceedingly, according to the soil and situation in which any of the varieties of this plant and *P. (s.) p. Mughus* are placed. The different varieties come tolerably true from seed, by which means they are generally propagated; but *P. (s.) p. Fischeri* has hitherto been inarched, not having yet ripened cones, either on the Continent or in Britain.

Statistics. The largest plants of *P. (s.) pumilio* in the immediate neighbourhood of London are at Syon, and in the Horticultural Society's Garden, where they are from 4 ft. to 6 ft. high. The largest in England are at White Knights, where there are a number of trees upwards of 30 ft. high; and several bushes of from 20 ft. to 30 ft. in diameter, and 10 ft. or 12 ft. high. At Dropmore, the bush of which *fig. 2063*, is a portrait, to a scale of 8 ft. to 1 in., is above 12 ft. high, and covers a space 25 ft. in diameter. At Hendon Rectory, there are several handsome conical plants in pots, from 3 ft. to 5 ft. high. At Bollwyller, plants of *P. (s.) pumilio* are 1 franc 50 cents, and of *P. (s.) p. Mughus* 1 franc, each. Plants of *P. uncinata*, in the London nurseries, are 10s. 6d. each; but, whether they are identical with *P. (s.) p. Mughus*, or with *P. s. 4 uncinata (p. 2156)*, we are uncertain, having only seen very small plants.



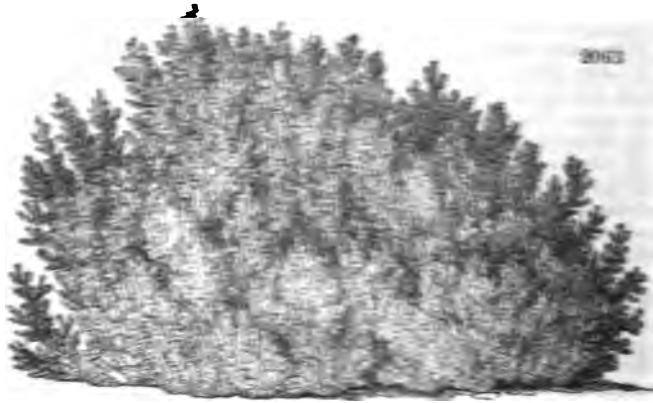

T 3. *P. BANKSIANA* Lamb. Banks's, or the Labrador, Pine.

Identification. Lamb. Pin., ed. 2, l. t. 2, Smith in Boiss. Cydon. No. 4; N. Du Ham., 3, p. 254; PARR. Fl. Amer. Sept., p. 342; Lond. Cat., N. S., Bot. Jard., ed. 1877, p. 74.
Synonymy. *P. sylvestris* *varicata* *Hort. Bor.* Kew., l. p. 266; *P. rubescens* Michx. N. Amer. Syl., 3, p. 18; *P. banksiana* Lam. *Encyc.*, 3, p. 248; Scrub Pine, Grey Pine, Hudson's Bay Pine; Yorea, Canada.
Engstromia. Lamb. Pin., ed. 2, l. t. 1; N. Du Ham., 3, t. 7, c. 1; Michx. N. Amer. Syl., 3, t. 135; our fig. 2064, in our usual scale of 1 in. to 2 ft.; and fig. 2065, of the natural size; all from Drepmore specimens.

Spec. Char., &c. Leaves in pairs, divaricated, oblique. Cones recurved, twisted. Crest of the anthers dilated. (Smith.) Bud $\frac{1}{2}$ in. long, and $\frac{1}{2}$ in. broad; cylindrical, blunt at the point, whitish, and covered with resin in large particles; central bud surrounded by from three to five smaller buds, as shown in fig. 2064. Leaves (see fig. 2065.) from 1 in. to $1\frac{1}{2}$ in. in length, including the sheath, which is short, and has three or four rings. Cones from $1\frac{1}{4}$ in. to 2 in. long. Leaves and cones retained on the tree three or four years. Scales terminating in a roundish protuberance, with a blunt point. Seeds extremely small.



Description. A low, scrubby, straggling tree, not rising higher in its native country, where it grows among barren rocks, than from 5 ft. to 8 ft.; but in British collections, in good soil, attaining more than three times that height. Occasionally, among the rocks of Labrador, Michaux observes, this pine produces cones, and even exhibits the appearance of decrepid old age, at the height of 3 ft.; and in no part of North America did he find it more than 10 ft. high. Dr. Richardson, however, in Franklin's *Narrative of a Journey to the Shores of the Polar Seas in 1819 and 1822*, describes *P. Banksiana* as a "handsome tree, with long, spreading, flexible branches, generally furnished with whorled curved cones, of many years' growth. It attains," he adds, "the height of 40 ft. and upwards in favourable situations; but the diameter of its trunk is greater, in proportion to its height, than in the other pines of the country. In its native situations, it exudes much less resin than *Abies alba*." (App. No. 7, p. 752.) Douglas found it on the higher banks of the Columbia and in the valleys of the Rocky Mountains, and his specimens have much longer leaves than are produced by the trees in Britain.

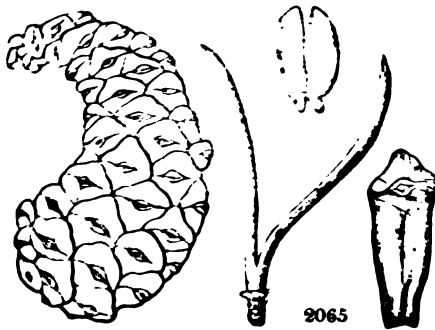

Notes. as a "handsome tree, with long, spreading, flexible branches, generally furnished with whorled curved cones, of many years' growth. It attains," he adds, "the height of 40 ft. and upwards in favourable situations; but the diameter of its trunk is greater, in proportion to its height, than in the other pines of the country. In its native situations, it exudes much less resin than *Abies alba*." (App. No. 7, p. 752.) Douglas found it on the higher banks of the Columbia and in the valleys of the Rocky Mountains, and his specimens have much longer leaves than are produced by the trees in Britain.

The species is readily known by the leaves being regularly distributed over the branches, instead of being collected in tufts alternating with naked spaces, as they appear to be in most other pines. In America, the leaves are about 1 in. long; but at Dropmore they are sometimes more than 1½ in. The catkins of both sexes are expanded in May, before those of *P. sylvestris*; but, as in that species, the cones do not attain their full size and maturity till the November of the second year, and do not open to shed their seeds till the spring of the third year. The cones are commonly in pairs, of a grey or ash colour (whence the American name of grey pine); they are above 2 in. long, and have the peculiarity of always pointing in the same direction as the branches. They are remarkable for curving to one side, which gives them the appearance of small horns. They are extremely hard, and often remain on the trees several years.



Geography, History, &c. *P. Banksiana*, according to Michaux, is found farther northward than any other American pine. In Nova Scotia and the district of Maine, where it is rare, it is called the scrub pine; and, in Canada, the grey pine. According to Titus Smith (*Mag. Nat. Hist.*, viii. p. 655.), it is called, in the neighbourhood of Halifax, the long-limbed Hudson's Bay pine. "In the environs of Hudson's Bay, and of the Great Mistassin Lakes, the trees, which compose the forests a few degrees farther south, disappear almost entirely, in consequence of the severity of the climate and the sterility of the soil. The face of the country is almost everywhere broken by innumerable lakes, and covered with large rocks piled upon one another, and usually overgrown with black lichens, which deepen the gloomy aspect of these desolate and almost uninhabited regions." (*Michx.*) Here and there, in the intervals of the rocks, Michaux adds, are seen a few individuals of the scrub pine; but they seldom grow higher than 3 ft. Dr. Richardson, in Franklin's *Narrative*, states that *P. Banksiana* was found exclusively occupying dry sandy soils. It occurred as far to the northward as lat. 64°; but it was said to attain higher latitudes on the sandy banks of the Mackenzie River. At what time, and by whom, this pine was introduced into Britain, is uncertain: it was in cultivation by Forsyth, in the Chelsea Botanic Garden, before 1785; but, as Mr. Lambert, in 1804, found a remarkably fine tree growing at Pain's Hill, it was in all probability planted there by the founder of the place, the Hon. Charles Hamilton, pre-



Hon. Charles Hamilton, pre-

vously to 1735 (see p. 70.). Mr. Lambert, writing in 1804, says that he then only knew of three trees of *P. Banksiana* in England that were of any size; viz., the one at Pain's Hill we have just mentioned, one at Kew, and another at Croome. The first is probably no longer in existence, because a party of four, of which we were one, searched a whole day for it in vain, in the grounds at Pain's Hill, on July 22. 1837; that at Kew is no more; and that at Croome, if it still exists, is not known to the gardener there. The handsomest tree that we know of *P. Banksiana* in England is that at Dropmore, of which *fig.* 2067. is a portrait to a scale of 1 in. to 8 ft.; and which was, in August, 1837, 27 ft. high, the diameter of the trunk 18 in., and that of the space covered by the branches 24 ft. It is a most elegant tree, well characterised by Dr. Richardson as having long, spreading, flexible branches. It bears abundance of cones, which remain on the trees for several years, and give the branches a singular appearance. There is a tree of this species 30 ft. high at White Knights, but it has not assumed so elegant a shape as that at Dropmore. There is a plant of it at Messrs. Loddiges's, 3 ft. 6 in. high; and one in the Horticultural Society's Garden, 3 ft. high. The only one that we have heard of in France is in the Jardin des Plantes, where, in 1837, it was 4 ft. high. The species is rather scarce in British nurseries.

Properties and Uses. Dr. Richardson mentions that the Canada porcupine feeds on the bark of this tree, and that the wood, from its lightness, and the straightness and toughness of its fibres, is much prized for canoe timbers. Titus Smith says that, on the shallow soils in the neighbourhood of Halifax, if not consumed by fires, it produces timber of a useful size. Michaux informs us that the Canadians find a speedy cure for obstinate colds, from a diet drink made by boiling the cones of *P. Banksiana* in water; and this is all, he says, that the tree is good for. As an ornamental tree, we think it one of the most interesting of the genus, from the graceful manner in which it throws about its long, flexible, twisted branches, which are generally covered throughout their whole length with twisted glaucous green leaves, with here and there a whorl of curiously hooked horn-like cones. It is one of the hardiest of the *Abietinæ*; enduring, in the Floetbeck Nurseries, 12° of Réaumur (5° Fahr.); and, therefore, it may be safely planted in pinetums in the extreme north, not only of Britain, but of Europe.

Soil, Propagation, Culture, &c. (See p. 2127.) Plants are raised from imported seeds, when these can be procured; but the species may be inarched, or grafted in the herbaceous manner, on *P. sylvestris*. (See p. 2129.) In the herbarium of the Horticultural Society, there are specimens of *P. Banksiana* sent home by Douglas, infested with a parasitic plant, resembling, in its ramifications, foliage, and colour, a mistletoe in miniature. It is the *Arceuthobium Oxycedri* Hook., and will be found figured in a future page.

Commercial Statistics. Price, in the London nurseries, 7s. 6d. each; at Bollwyller, 2 francs.

B. Cones large, having the Scales furnished with Prickles.

4. *P. INOPS* Ait. The Jersey, or poor, Pine.

Identification. Ait. Hort. Kew., ed. 1., 3. p. 367., ed. 2., 5. p. 316.; Smith in Ross's Cyclo. No. 10.; Willd. Sp. Pl., 4. p. 496.; Baumg., 508.; Mart. Mill., No. 3.; Lamb. Pin., ed. 2., 1. t. 12.; N. Du Ham., t. 5. p. 236.; Michx. N. Amer. Syl., 3. p. 129.; Hayne Dend., No. 4.; Lodd. Cat., ed. 1836.; Bon Jard., 1837., p. 478.; Lawson's Manual, p. 346.

Synonymes. *P. virginiana* Du Roi Harbt., ed. Fott., 2. p. 47., Mill. Dict., No. 9., Wangh. Bot., p. 74.; Pin chétif, Fr.

Engravings. Lamb. Pin., ed. 2., 1. t. 12.; N. Du Ham., t. 69. f. 1.; Michx. N. Amer. Syl., 3. t. 157.; our *fig.* 2070., to our usual scale; and *figs.* 2068. and 2069., of the natural size; all from Dropmore specimens.

Spec. Char., &c. Leaves in pairs. Cones drooping oblong-conical, longer than the leaves. The scales awl-shaped, with prominent prickles. Crest of the anthers short, broad, jagged. (*Smith.*) Bud (*fig.* 2068.) from $\frac{1}{4}$ in. to $\frac{1}{2}$ in. long, and $\frac{1}{4}$ in. broad; cylindrical, blunt at the point, resinous, brown, and surrounded by three small buds. Cone (*fig.* 2069.) from $2\frac{1}{2}$ in. to $3\frac{1}{2}$ in. long, and from 1 in. to $1\frac{1}{2}$ in. broad. Some of those at Dropmore are of the last dimensions. Scales of a hard woody texture, of a yellowish brown colour, with a sharp woody prickle pro-



jecting from each, which is generally straight. Leaves from 1½ in. to 2½ in. long. Sheaths with 3 or 4 rings. Seeds small, cotyledons 6 to 8. Young shoots covered with a fine purplish glaucous bloom.

Description. A tortuous-branched low tree, having, at a distance, the general appearance of *P. Banksiana*; but differing from that species in having many of the more slender branches pendulous, and the wood of the shoots of the current year conspicuously glaucous and tinged with violet; a character which, as Michaux observes, is peculiar to this species and to *P. mitis*; and the trunk and larger branches producing small tufts of leaves, or abortive shoots. According to Michaux, it grows, in North America, from 30 ft. to 40 ft. in height, with a dark-coloured trunk, and the branches proceeding from it, not in whorls, but irregularly, more in the manner of broad-leaved trees than is usual with the *Abiétinæ*. The bark, in old trees, is deeply cracked; and through the fissures resin exudes in such abundance, as to give the trunk and branches the appearance of being candied over with sugar. The leaves are of a dark green, and scattered equally over the branches,

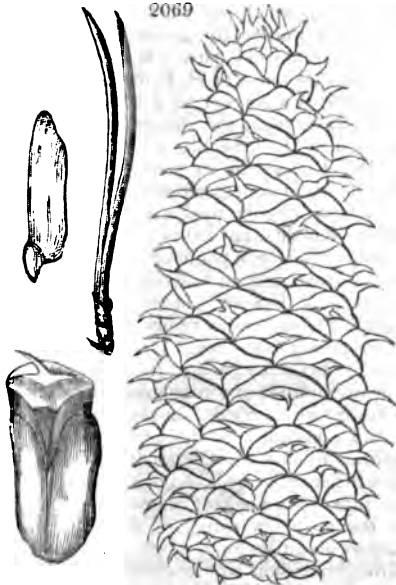

in the manner of *P. Banksiana*; but they are not so persistent, nor so glaucous, as in that species. The cones, Michaux describes as about 2 in. long, and 1 in. in diameter at the base: they are attached by short thick peduncles, and are armed with long fine awl-shaped spines; they are usually single, and turned more or less towards the ground. In the neighbourhood of New York, in lat. 41°, the flowers appear in the beginning of May; the cones are mature in the November of the second year; and the seed drops out the following spring. The trees of this species in the pinetum at Dropmore agree very well with Michaux's description; but they are not yet sufficiently old, or, perhaps, our summers are not sufficiently warm, to cause an exudation of resin to the extent mentioned by that author. The buds, however, are resinous; and this matter very readily exudes, and incrusts the surface of the sections wherever a branch is cut off. At Dropmore, in warm weather during sunshine, the fragrance of the air in the neighbourhood of this tree is delightfully balsamic.



Geography, History, &c. The Jersey pine inhabits the interior of North America, chiefly south of latitude 45°; and, according to Pursh, it is found from New Jersey to Carolina, on dry barren soils. Michaux states that it abounds in the lower parts of New Jersey, where the soil is meagre and sandy, and where it is often accompanied by the yellow pine (*P. mitis*); and that it is also found in Maryland, Virginia, and Kentucky; in Pennsylvania,



beyond Chambersburg, near the Juniata, and on the scrubby ridges beyond Bedford, at the distance of about 200 miles from Philadelphia. In this part of Pennsylvania, it is called the scrub pine; and it is seen wherever the soil is composed of argillaceous schistus, and is consequently poor. The pooriness of the soil on which it grows is attested by the decrepid appearance of the scarlet, red, black, white, and rock-chestnut oaks, among which it grows. Michaux never saw it northward of the river Hudson; and neither in the Carolinas, nor in Georgia. According to the *Hortus Kewensis*, it was cultivated in 1739, by Miller; but, though it is a singular-looking, and in our opinion most interesting, tree, it is not common in British collections. The finest trees of it which we have seen are at Pain's Hill, where it is 40 ft. high, with a trunk 1 ft. 6 in. in diameter; and at Dropmore and White Knights, at both which places, it bears abundance of cones. Fig. 2071. is a portrait of one of the three Dropmore trees, which, after being 17 years planted, was, in 1837, 25 ft. high, with a head covering a space 24 ft. in diameter. There are three fine trees at White Knights, from 25 ft. to 30 ft. high, which have retained their cones ten or twelve years; and many of the shoots of which appear to be as amply furnished with cones as leaves. A tree at Syon is 14 ft. high. There is a low, crooked, pendulous-branched tree of this species in the arboretum at Kew, about 10 ft. high; one at Messrs. Loddiges's 5 ft. high; and one of the same height, which has been 7 years planted, in the Horticultural Society's Garden. In France, according to the *Nouveau Du Hamel*, there is a tree 20 ft. high in the gardens of the Trianon; and M. Héricaut de Thury has several trees which produced cones at the age of 20 years, and have since continued to do so every year.

Properties and Uses. The wood of the Jersey pine, according to Michaux, is of little use, except for fuel, on account of its small dimensions, and the large proportion of sap wood which it contains; but, as it abounds in resin, tar is obtained from it. Kalm mentions, in his *Travels in North America*, that, in the heat of summer, cattle resort for shade to this tree, in preference to any other, even though their foliage were much thicker. He saw cattle studiously singling out *P. inops* in order to get under its branches; probably

from the gratefulness of its fragrance; for it is highly probable that the brute animals, especially in a wild state, are even more sensible of the odour of trees than the human species. Michaux concludes his observations on this tree by remarking that, next to the grey pine (*P. Banksiana*), it is the most uninteresting species in the United States; but as, in Europe, almost all the American pines can only be considered in the light of ornamental trees, this species, as such, well deserves a place in collections, from the singularity of its form, its delightful fragrance, and its hardness.

Soil, Propagation, &c. Plants are sometimes raised from imported seeds; or they may be inarched, or grafted in the herbaceous manner, on *P. sylvestris*. (See p. 2127. and p. 2129.)

25. *P. MITIS* Michx. The soft-leaved, or yellow, Pine.

Identification. Michx. Fl. Bor. Amer., N. Amer. Syl., 3 p. 190; Lodd. Cat., ed. 1836; Bon Jard., ed. 1837.

Synonymæ. *P. variabilis* Pursh Fl. Amer. Sept. p. 642., N. Du Ham. 5. p. 234.; ? *P. echinata* Mill., Dict. No. 12.; New York Pine, Spruce Pine, Short-leaved Pine, Amer. *Ergebnisse.* Michx. N. Amer. Syl., 3. t. 157.; our figs. 2076. from Dropmore, and 2075. from Michaux, to our usual scale; and figs. 2072., 2073., and 2074., of the natural size.

Spec. Char. Leaves long, slender; hollowed on the upper surface. Cones small, ovate-conical. Scales with their outer surface slightly prominent, and

terminating in a very small slender mucro, pointing outwards. (*Michaux.*) Buds, on a young tree (fig. 2072.), $\frac{1}{4}$ in. long, and $\frac{1}{8}$ in. broad; on an old tree, larger (fig. 2073.); scarcely resinous. Leaves (fig. 2074. from Michaux), from $2\frac{1}{2}$ in. to 4 in. long, with sheaths $\frac{1}{2}$ in. long; white, lacinated, afterwards becoming dark, slightly ringed. Cone, 2 in. long, and 2072 1 in. broad in the widest part.

Seeds small; with the wing, $\frac{3}{4}$ in. long. Young shoots covered with a violet-coloured glaucous bloom, like those of *P. inops*, by which it is readily distinguished from the *P. variabilis* of Lambert.

Description. A beautiful tree; according to Michaux, 50 ft. or 60 ft. high, with a trunk of a uniform diameter of 15 in. or 18 in. for nearly two thirds of its length. The branches are spreading on the lower part of the trunk, but become less divergent as they approach the head of the tree, where they are bent towards the body so as to form a summit regularly pyramidal; but not spacious in proportion to the dimensions of the trunk. This narrow conical appearance of the head, as compared with the spreading character of those of other species, seems to have given rise to the name of spruce pine in America. The leaves, according to Michaux, are 4 in. or 5 in. long, fine and flexible (whence the specific name of *mitis*, soft), hollowed on the upper surface, of a dark green, and united in pairs. Sometimes, from luxuriance of vegetation, three leaves are found in the same sheath on young shoots, but never on old branches. The cones are oval, armed with fine spines, and smaller than those of any other American pine; scarcely exceeding $1\frac{1}{2}$ in. in length, even upon old trees. The concentric circles of the wood of the yellow pine, Michaux states, are six times as numerous, in a given space, as those of the pitch pine (*P. rigida*) and the loblolly pine (*P. Taeda*). "In trunks 15 in. or 18 in. in diameter, there are only 2 in. or $2\frac{1}{2}$ in. of sap wood, and still less in such as exceed this size. The heart wood is fine grained, and moderately resinous, which renders it compact, without its being of great weight. Long experience has proved its excellence, and durability." (*Michx.*)





Geography. The yellow pine is found in most pine forests, from New England to Georgia. Towards the north, it does not extend beyond some districts of Connecticut and Massachusetts. It is abundant in the lower part of New Jersey, and still more so on the eastern shore of Maryland, and in the lower parts of Virginia, where it is seen only on the most arid soils. Michaux "also met with it on the right bank of the river Hudson, at a little distance from Albany; at Chambersburg, in Pennsylvania; near Mudlick, in Kentucky; on the Cumberland Mountains, and in the vicinity of Knoxville, in East Tennessee; at Edgefield Court House, in the upper part of South Carolina; and on the river Oconee, in the upper part of Georgia. In all these places, it is found growing along with other



trees; and it enters, in a greater or less proportion, into the composition of the indigenous forests, according to the nature of the soil. It abounds on the poorest lands; but on those of a certain degree of fertility, which is indicated by the flourishing appearance of the oaks and walnuts, it is more rare, though it still surpasses the surrounding trees in bulk and elevation. The yellow pine is also occasionally seen in the lower part of the Carolinas, in the Floridas, and probably in Louisiana; but in these regions it grows only on spots consisting of beds of red clay mingled with gravel, which here and there pierce the light covering of sand which forms the surface of the country to the distance of 120 miles from the sea."

History. When *P. mitis* was introduced into England is uncertain; unless we conclude that it was the *P. echinata* of Mill. *Dictionary*, in which case it was in cultivation in 1739. The *P. variabilis* of Lambert's *Pinus* is unquestionably a totally different plant from the *P. mitis* of Michaux; being without the violet-coloured glaucous bloom on the young shoots; having rigid leaves, generally in threes; and a cone with very strong prickles, like that of *P. Tæda*, to which species we have referred it. The only plants that we know which answer to Michaux's description of *P. mitis* are at Dropmore, where they are readily known by the violet-coloured glaucous bloom on the young shoots, and by the leaves being almost all in twos; at the same time, it is proper to mention, that the leaves there, though soft and slender, are much shorter than those in Michaux's figure. The name applied to this species at Dropmore is *P. variabilis*. There is also a plant at Dropmore named *P. mitis*; but it is wholly with three leaves; and, as far as we can ascertain (the tree not having yet borne cones), it belongs either to *P. serotina*, or to some variety of it. The description given by Miller of *P. echinata*, as having finely elongated leaves, and a cone with very slight slender prickles, agrees perfectly



well with this species, as described by Michaux; and not at all with Mr. Lambert's *P. variabilis*, which he describes as having leaves only 2 in. long, and cones with scales having "thorny points of a strong woody texture projecting from them."

Properties and Uses. In the northern and middle states, and in Virginia, Michaux tells us that, in his time, to the distance of 159 miles from the sea, nine tenths of the houses were built entirely of wood; and the floors, the casings of the doors and wainscots, the sashes of the windows, &c., were all made of the wood of the yellow pine, as being more solid and lasting than that of any other kind of indigenous tree. "In the upper part of the Carolinas, where the cypress (*Taxodium distichum*) and the white cedar (*Cupressus thyoides*) do not grow, the houses are constructed wholly of the yellow pine, and are even covered with it." (*Michx.*) It is necessary, however, whenever the wood of this tree is used for building purposes, that it should be completely freed from its sap wood, which speedily decays. This precaution, Michaux tells us, "is sometimes neglected, in order to procure wider boards, especially near the sea-ports, where, from the constant consumption, the tree is becoming rare. Immense quantities are used in the dockyards of New York, Philadelphia, Baltimore, &c., for the decks, masts, yards, beams, and cabins of vessels; and it is considered to be next in durability to the long-leaved pine (*P. australis*). The wood from New Jersey and Maryland is finer grained, more compact, and stronger than that from the river Delaware, which grows upon richer lands." (*Michx.*) The yellow pine, in boards from 1 in. to 2½ in. thick, forms a considerable article of commerce between the United States, and Great Britain and the West Indies. At Liverpool, it is called the New York pine, while at Jamaica it is called the yellow pine; and, in both places, it sells at a much higher price than the wood of the white pine (*P. Strobus*), though it is considered inferior to that of *P. australis*. In the *Minutes of Evidence* taken before a select committee appointed to consider of the means of maintaining and improving the foreign trade of the country, and printed by order of the House of Commons, in March, 1821, John White, Esq., of Westbourne Green, an extensive timber merchant, was examined. In answer to the question, "Can you speak at all to the durability of different kinds of wood?" he says, "In general, Norway timber is the most durable of the fir timbers of Europe; because, after many years, it does not part with its resinous particles; but I consider," he adds, "that the American soft, or yellow, pine (*P. mitis Michx.*) is the most durable of the American firs. I have known it last, when exposed to the action of the sun and weather, for a long period, by the side of Norway timber, with equal effect, fully exposed to wind and rain; but, if painted, it does not stand at all so well." (*Report, &c.*, 1821, p. 23.) "Though this species," Michaux observes, "yields turpentine and tar, their extraction demands too much labour, as this pine is always mingled in the forests with other trees." This is another point in which Michaux's account differs from that of Mr. Lambert; as the latter informs us that "the wood has a sponginess and lightness which deprive it of durability, and render it useless in building, or, indeed, for any purposes of a similar kind; but it is tolerably full of resin, so that the Americans employ it for its tar and pitch." (*Lamb. Pin.*, ed. 2., i. t. 14.) The tree of *P. mitis* at Dropmore (there named *P. variabilis*, and easily known from others having the same name, by the characteristics already mentioned) was, in 1837, after being 41 years planted, 29 ft. high.

Commercial Statistics. Cones, in London, are 1s. per quart, and plants 5s. each; at Bollwyller, plants are 2 francs each; and at New York, 50 cents.

† 6. *P. PUNGENS Michx.* The prickly-coned, or Table Mountain, Pine.

Identification. Michx. Arb., 1. p. 61.; Pursh Fl. Amer. Sept., 2. p. 643.; Lamb. Pin., ed. 2., 1. t. 17.; N. Du Ham., 5. p. 236.; Lawson's Manual, p. 363., Lodd. Cat., ed. 1836.
Engravings. Lamb. Pin., ed. 2., 1. t. 17.; N. Du Ham., t. 67. f. 4.; Michx. N. Amer. Syl., iii. t. 140. t. our fig. 2079., to our usual scale; and figs. 2077. and 2078., of the natural size; all from Dropmore specimens.

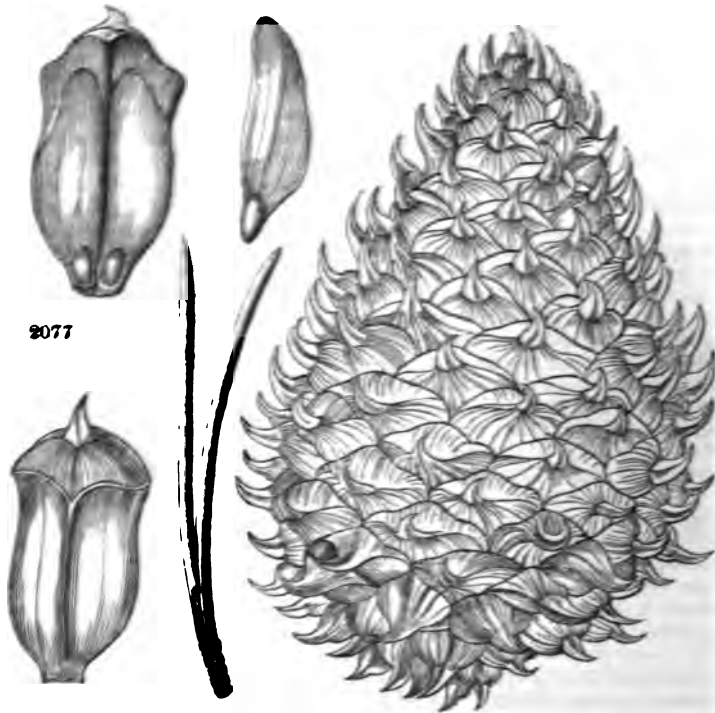

Spec. Char., &c. Leaves short and thickly set. Cones top-shaped, very large, yellow. Scales with hard incurved prickles, thick, and broad at the base. (*Micks.*) Bud (*fig. 2078.*) from $\frac{1}{2}$ in. to $\frac{2}{3}$ in long, and $\frac{1}{2}$ in. broad; cylindrical, blunt at the point; brownish, and covered with white resin; generally without small buds. Leaves (*fig. 2077.*) $2\frac{1}{2}$ in. long, including the sheath, which has 4 or 5 rings; the leaves are much broader, and rather shorter and lighter, than those of *P. (s.) pumilio*, and tipped with a sharp point. Cone $3\frac{1}{2}$ in. long, and about $2\frac{1}{2}$ in. broad. Scale woody, and furnished with a strong awl-shaped hook, exceeding $\frac{1}{2}$ in. in length. Seeds nearly as large as those of *P. sylvestris*, rough and black. Cotyledons from 6 to 8.

Description, &c. A tree 40 ft. or 50 ft. high, with the habit of *P. sylvestris*, but with a much more branchy head; and readily distinguished from that species by the young leaves not being glaucous, and by the leaves generally being more straight and rigid, slightly serrated at the margins, and with shorter sheaths. The leaves are also of a paler green, both when young and full grown, so that the tree, when of large size, has nothing of the gloomy appearance attributed to the Scotch pine. The cones are of a light yellowish brown colour, without footstalks; and they are generally in whorls of 3 or 4 together, pointing horizon-





tally, and remaining on the tree for many years. At Dropmore, there are cones adhering to the trunk and larger branches of more than 20 years' growth, giving the tree a very singular appearance; and rendering its trunk easily distinguishable, even at a distance, from those of all others of the pine tribe. The geographical range of this tree, according to Michaux, is very limited, it being chiefly found on the Table Mountain in North Carolina, one of the highest points of the Alleghanies, at nearly 300 miles from the sea, which summit it covers almost exclusively, being rare on the adjoining ones. Pursh only mentions the Grandfather and Table Mountains as its habitats; but Mr. William Strickland, who introduced the species into England, stated to Mr. Lambert that he observed large forests of it on the Blue Mountains, on the frontiers of Virginia. Of all the forest trees of America, Michaux observes, this is the only species restricted to such narrow limits; and it will, probably, be among the first to become extinct, as the mountains which produce it are easy of access, are favoured with a salubrious air and a fertile soil, and are rapidly peopling; besides which, their forests are frequently ravaged by fire. *P. pungens* was introduced into England in 1804; and, as cones are frequently imported, it is occasionally to be found in collections. The largest tree we know of is at Dropmore; where, in 1837, it was 34 ft. high; the diameter of the trunk 1 ft. 9 in., and of the head 33 ft. *Fig. 2080.* is a portrait of this tree. There is a tree in the Horticultural Society's Garden, 8 ft. high; and a small plant at Messrs. Loddiges's. In America,

the timber is applied to no particular use; but its turpentine is preferred to that of every other kind of pine for dressing wounds. Michaux could not discover the slightest difference, however, between this turpentine and that of the pitch pine (*P. rigida*); and, indeed, he says that the resin of all the pines is so analogous in properties, as often to be undistinguishable by the taste and smell. In Britain, *P. pungens* can only be considered as an ornamental tree; but, from the singularity of its cones, it well deserves a place in every pinetum. Another inducement is the probability of its becoming extinct in North America. Price of cones, in London, 3s. per quart; plants 7s. 6d. each; and at Bollwyler, 3 francs each.

§ ii. *Laricio*.

Sect. Char. Cones with the outer surface of the scales more or less elliptical in shape, with a horizontal rib or line from each extremity, terminating in a blunt slightly protruding point in the centre; generally much shorter than the leaves. Buds large, ovate-acuminate, concave on the sides, and terminating in an elongated point, like a camel-hair pencil. The scales of the buds adpressed, incrustated with white resin. Leaves twice the length of the cones; in no stage of their growth glaucous, but of a darker green than those of any other section of either European or American pines; remaining on the tree four years. Natives of Europe.

§ 7. *P. LARICIO* Poir. The Corsican, or Larch, Pine.

Identification. Poir. in Lam. Encyc., 5. p. 338; Lam. et Dec. Fr. Fl., 3. p. 274; N. Du Ham., 5. p. 239; Lamb. Pin., ed. 2., 1. t. 4.; Don in Neill's Hort. Tour, p. 552; Lawson's Manual, p. 336; Bon Jard., ed. 1837, p. 974.; Lodd. Cat., ed. 1836; Hayne Dend., p. 172.

Synonymes. *P. sylvestris*; *maritima* Mill. Hort. Kew., ill. p. 366.; *P. maritima*, ed. 2., v. p. 315.
Engravings. Lamb. Pin., ed. 2., 1. t. 4.; N. Du Ham., t. 69. and 69. f. 2.; our fig. 2084., to our usual scale, from a specimen received from the Horticultural Society's Garden; figs. 2081. to 2083., of the natural size; and the plates of this tree in our last Volume.

Spec. Char. Leaves lax, twice the length of the cones. Cones conical, often in pairs, sometimes, but rarely, in threes or in fours. Scales convex on the back, elliptic in their general form, scarcely angular, and very slightly pointed. Male flowers almost sessile, elongated, having the anthers terminated by a small round crest. (N. Du Ham., and obs.) Bud (see fig. 2081.) from $\frac{1}{2}$ in. to 1 in. long; and from $\frac{3}{8}$ in. to $\frac{1}{2}$ in. broad; ovate, with a long narrow point, and concave at the sides, resembling a camel-hair pencil. Scales adpressed, and incrustated with white resin. The centre bud generally surrounded by three or more small buds. Cones varying from 2 in. to 3 in. or more in length; and from $\frac{1}{2}$ in. to 1 $\frac{1}{2}$ in. in breadth. The points of the scales turned over like an under lip, and terminating in a point which has a very small prickle, often scarcely perceptible. The colour of the cone tawny, and the interior part of the scales purple. Leaves varying in length from 4 in. to 6 in. and upwards; generally two in a sheath on the side branches, but occasionally three on the leading shoots.

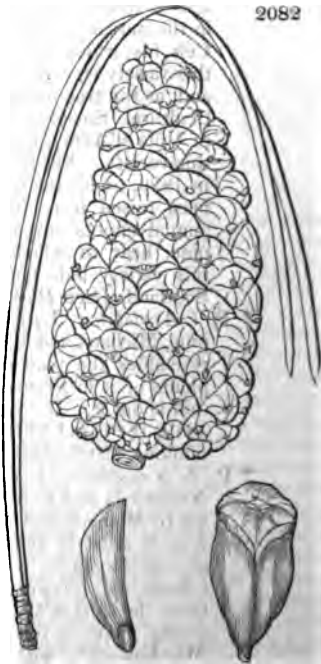

Seeds greyish or black, twice as large as those of *P. sylvêstris*. Cotyledons (see fig. 2083.) 6 to 8.

Varieties. Judging from the names in Continental catalogues, these are numerous; but, as these names are chiefly expressive of different localities, we are ignorant how far the plants are really distinct. In the *Nouveau Du Hamel*, only one variety is given, which is characterised by the cones being greenish, those of the species being described as of a tawny or fawn colour. Delamarre, in his *Traité Pratique, &c.*, enumerates five varieties, some of which, however, are considered by M. Vilmorin as being probably species; the cones not having yet been seen.

‡ *P. L. 1 corsicàna*; Laricio de l'Île de Corse, *Delamarre*.—Cones of a tawny or fallow colour.

‡ *P. L. 2 subviridis* Nouveau Du Hamel. — Cones of a greenish yellow.

‡ *P. L. 3 caramànica*; *P. caramànica Bosc*; *P. caramaniensis Bon Jard.*, ed. 1837, p. 974.; Laricio de Caramanie, ou de l'Asia Mineure, *Delamarre*; ? *P. romàna Lond. Hort. Soc. Gard.*—*P. L. caramànica* seldom grows to above half the height of *P. L. corsicàna*: it has a much rounder and more bushy head, with straight, or nearly straight, leaves, slender branches, reddish-coloured bark, and reddish buds, which are wholly, or in part, covered with white resin. The scales of the cones, which are larger than those of *P. L. corsicàna*, are tipped with a harder and more horny point. This pine was introduced into France by Olivier, the author of *Travels in the Levant*, in the year 1798; and there were trees of it, producing cones with fertile seeds, in the grounds of Malmaison, in 1836. There is also a tree in the garden of M. Pérignon, at Auteuil; one in the nursery of M. Noisette; and another in that of M. Cels, fils, which has ripened seeds. Delamarre remarks that this variety is, in the French nurseries, erroneously called *P. romàna*; and, as the tree bearing this name in the garden of the London Horticultural Society, now 20 ft. high, was received from Godefroy of Ville d'Avray, near Paris, in 1825 or before, it is most probably this variety. Seeds of this variety were sent to us from Germany in 1829, under the name of *P. resinosa*, and the plants which have been raised from them are found, at Methven Castle, to produce annual shoots surpassing in length those of the common Scotch pine, near to which they are planted. Mr. Bishop states that this variety bids fair to become available for the poorer soils of Scotland. (See *High. Soc. Trans.*, vol. xi. p. 124.)

‡ *P. L. 4 calàbrica*; Laricio de Mont Sila en Calabre, *Delamarre*.—This pine, Michaux and Vilmorin remark, in a note to Delamarre's work, resembles the pine of Caramania; but, as there are only young plants of it in France, which have not yet fruited, very little can be said about it. It was introduced into France by M. Vilmorin in 1819, 1820, and 1821; and 100 lb., of seeds, containing about three millions, distributed.

‡ *P. L. 5 austriaca*; Laricio d'Autriche, ou de la Hongrie, *Delamarre*.—Noisette is said to have found this variety in Hungary; but, according to Michaux and Vilmorin, in their notes to Delamarre's *Traité, &c.*, it scarcely differs from *P. caramànica*, which they say grows also in Romania, and in the Crimea. The *P. austriaca* of Höss (*Anleit. die Bäume und Sträucher Oesterreichs, &c.*, p. 6.), judging from the author's description, and from comparing the buds of the young plants in the Horticultural Society's Garden, received from Mr. Lawson's, with plants of the same age of *P. L. corsicàna*, appears to be a variety of that species, and is probably identical with the Laricio d'Autriche of Delamarre; but, as we have not



seen the cones, and as the plant is now being extensively distributed, through the activity of Mr. Lawson, we have considered it best, in the meantime, to give it in the form of a species.

‡ *P. L. 6 pyrenæica*; *P. hispánica* Cook; ? *P. pyrenæica* Lap.—From the buds of the young plants of this pine, in the Horticultural Society's Garden, and more especially from the cones, some of which we received from Captain Cook, we are induced to refer it also to *P. Laricio*; but, as it seems a very distinct and beautiful variety, and as it has been lately extensively distributed by Captain Cook, who introduced it, we shall also give it in the form of a species.

‡ *P. L. 7 taurica*.—There is a tree bearing this name in Loddiges's arboretum, which is not introduced into their catalogue for 1836, and which appears, from its buds, to be identical with *P. taurica* (Lodd. Cat., ed. 1836.) of the same collection; and of which name *P. Pallasiána* is a synonyme: but, as this variety of *Laricio* is very distinct, particularly in the greater length of the cones and leaves, we have given it as a species.

Other Varieties. *P. altissima* and probably some other names are applied to *P. Laricio*, or some of its varieties, but not in such a manner as to enable us to state anything satisfactory respecting them. The only truly distinct forms of this species, in our opinion, are, *P. L. corsicana*, *P. L. caramánica* (of which there is a handsome tree in the Horticultural Society's Garden, under the name of *P. romána*), *P. L. Pallasiána* (of which there are trees at White Knights and Boyton), and perhaps *P. L. pyrenæica*.

Description. A tree, attaining the height of from 80 ft. to 100 ft., with a regular pyramidal head, and the branches disposed in whorls, of five or six in a whorl; which are distinguished from the branches of *P. Pináster*, by being often twisted and turned in a lateral direction at their extremities, especially in full grown trees. In the Island of Corsica, it is said that there are trees of this species from 140 ft. to 150 ft. in height. The trunk and branches of full-grown trees have a reddish grey-coloured bark, not unlike that of *P. sylvestris*; and the bark of the trunk cracks, and partially separates in the form of large plates, as in that tree. The leaves vary much in length, according to the age of the tree, and the soil on which it grows. The shortest are generally 4 in. or 5 in., and the longest 7 in. or 8 in. long. They are slender, not sensibly rough, and much darker-coloured than those of either *P. sylvestris* or *P. Pináster*. In young plants, and on the extremities of the shoots of the lower horizontal branches of old trees, they are frequently much waved and twisted; but near the top of the tree they are straight; and on the leading shoot of young trees, three leaves are occasionally found in a sheath. The sheaths of the leaves vary from $\frac{1}{2}$ in. to 1 in. in length, and have generally 4 or 5 rings. At first, the sheath is white and membranaceous; but it becomes torn and shortened as the leaves advance in age, and ultimately becomes black. The male catkins, which are produced at the extremities of the shoots, are from 6 to 15 in number, and they are surrounded by numerous scales. They are from 1 in. to $1\frac{1}{2}$ in. in length, and from $\frac{1}{4}$ in. to $\frac{1}{2}$ in. in breadth; yellowish before the bursting of the anthers, which are terminated by a round crest, and which contain abundance of pollen, of a beautiful sulphur colour. After the male catkins drop off, the part of the young shoot which they occupied is left naked; and hence the branches of old trees, particularly at their extremities, have those tufts of leaves, alternately with naked places, which are so conspicuous

2084



in *P. Pinaster*, and all the pines which have either large and very scaly buds, or which produce a great number of male catkins. The female catkins are egg-shaped, reddish, becoming straight after flowering, and they are borne on peduncles, from $\frac{1}{2}$ in. to $\frac{3}{4}$ in. in length, surrounded at the base with scariosus scales; the fleshy scales which form the female catkin are terminated by a blunt triangular point, which is often persistent, and which, when the cone is mature, renders it very slightly prickly. The cones are commonly in pairs, but sometimes three and sometimes four occur together: they point horizontally and slightly downwards, and sometimes they are slightly curved, so as to be concave at the extremity of the side next the ground. They are from 2 in. to 3 in., or more, in length; of a ruddy yellow or tawny colour, or greenish. They attain their full size in the November of the second year, and shed their seeds in the April of the third year. The scales of the cones are remarkably distinct from those of *P. sylvestris*, and the prickly cones of *Pinops*, and *Tæda*, on the one hand, and from the hard, angular, regular-sided scales of the cones of the sections of *Pinaster* and *Halepenses*, on the other. The seeds of *P. Laricio* are greyish, and marked with black spots: deprived of their wings, they are scarcely $\frac{1}{2}$ in. in length, but with the wings they are more than 1 in. The tree is readily known from *P. sylvestris* by its more conical form, and crowded, longer, and darker foliage; and from *P. Pinaster*, from many of its branches being twisted, as it were, round the tree, and from its foliage being shorter, more slender, and much darker. The rate of growth, even in Britain, is more rapid than that of *P. sylvestris* in a similar soil and situation; being, in young trees, in the climate of London, from 2 ft. to 3 ft. in a year. A tree in the Horticultural Society's Garden (see the portrait of this tree in our last Volume), having been 12 years planted, was, in 1834, 20 ft. high; and is now (1837) 25 ft. high. A shoot of the year 1829, with part of 1828, cut from a tree 5 years old, on M. Vilmorin's estate at Barres, and sent to Mr. Lawson's museum, measured 3 ft. in length, and $3\frac{1}{2}$ in. in circumference at the thickest end. The leading annual shoot of a tree in the Horticultural Society's Garden, which was blown off on August 20. 1837, measured 2 ft. 6 in. in length, and $\frac{3}{4}$ in. in diameter at the lower end, where it had been pierced by an insect; and, though not arrived at their full growth, its leaves, which are in part in threes, were 4 in. in length; whilst those of the last year's shoot, from which it sprang, were $8\frac{1}{2}$ in. In the *Gardener's Magazine* (vol. i. p. 79.), it is stated, that, a young plant of *P. Laricio* being planted in 1817, at the same time with a young plant of *P. sylvestris*, on a sandy hill in one of the coldest counties of the eastern part of England, in 1825 the Scotch pine was only 6 ft. or 7 ft. high, while *P. Laricio* had attained a height of upwards of 12 ft. In the arboretum of Messrs. Loddiges, this pine has attained a larger size than any other species, and thrives better than any other, with the exception of *P. Pinaster* and *P. Pinæa*, there being four trees, under the names of *P. Laricio*, *P. L. taúrica*, *P. taúrica*, and *P. romana*, from 20 ft. to 30 ft. high; while the Scotch pine and its varieties are not above 12 ft. high, and the American pines not above half that height. In France, according to Thouin, *P. Laricio* grows two thirds faster than the Scotch pine, placed in a similar soil and situation. The duration of the tree in Corsica is from 70 to 80 years, and its average height about 130 ft. (40 mètres); and the diameter of the trunk from 23 in. to 27 in. (6 to 7 décimètres). The finest young trees in the neighbourhood of London are in the Horticultural Society's Garden; and the finest old tree at Kew, where it is named *P. maritima*, and of which a portrait is given in our last Volume.

Geography. The *Pinus Laricio* is a native of Corsica, and of various other parts of Europe. P. B. Webb, Esq., discovered it on Mount Ida, in Phrygia, and Mr. Hawkins found in Greece, on Cyllene, Taygetus, and the mountains of Thasos, a sort of pine which, from the description given in Walpole's *Memoirs* relative to Turkey, is considered by Mr. Lambert to be this species. According to Baudrillart, it grows equally well on mountains of the second order in the interior of Spain, on the sandy plains along the shores of the Mediterranean, and in a great part of the north of France. It is said to be

found in Hungary, in the Hartwold in Leimersbachle, in Germany; and it abounds on Caucasus, and in the south of Russia, and probably generally throughout the south of Europe, and great part of the west and north of Asia. It does not appear to grow on the very poorest soils, or at very great elevations; and to require a deeper soil than *P. sylvestris*.

History. The Corsican pine was scarcely known in France, as a distinct species, in the time of Du Hamel; and was subsequently, according to Bosc, confounded by authors with the *Pinus sylvestris*, under the name of *P. s. altissima*; and with the *Pinus maritima* (our *P. Pinaster*), under the name of *P. m. Pinaster*; from its, in fact, holding a middle place between these two species. The name of *P. Laricio* was first given to it by Poirer, in the *Dictionnaire Encyclopédique*; and it was subsequently adopted by De Candolle, in the *Flore Française*. *P. Laricio* was introduced into England under the name of *P. sylvestris* γ *maritima* in 1759; and that name was adopted by Aiton, in the first edition of the *Hortus Kewensis*; and afterwards changed, in the second edition, to *P. maritima*. The name of *P. Laricio* was first adopted in Britain in 1822, in consequence of the description, by Professor Don, of a tree in the Paris Garden, being published under that name in an Appendix to Neill's *Horticultural Tour through France and the Netherlands*. Seeds were soon after imported by Mr. Malcolm, from M. Vilmorin, and a number of plants raised, which have been distributed throughout the country, though we are not aware that they have been planted any where in large masses. In France, according to Mordant de Launay, as quoted by Delamarre, *P. Laricio* first attracted the notice of government under the ministry of Turgot, in the time of Louis XVI.; and the fine tree in the Paris Garden was planted where it now stands in the year 1774, being then several years old. The government had great difficulty in procuring seeds from its agents in Corsica: the cones being produced only in small quantities, and at the summits of the trees, it was difficult, and even dangerous, to gather them; and this circumstance tempted the dealers in these seeds to mix them with those of *P. Pinaster*, which they could procure with facility. In 1788, the Corsican pines began to be employed for masts for the French navy; and, when the trees were cut down, the cones were easily gathered. The late André Thouin was employed by the French government, about the year 1814, to draw up directions for cultivating this tree, which were printed and published, together with an account of its properties and uses in Corsica, and a strong recommendation for its culture in France. Nevertheless, the seed not having been procured in sufficient quantities, grafting was resorted to, in the year 1822; and M. Larminat (as we have seen, p. 2130.) grafted many thousands of *P. Laricio* on *P. sylvestris* in the Forest of Fontainebleau. Since that time, this pine has been strongly recommended for culture by M. Vilmorin, who has planted all the varieties of it extensively on his estate at Barres, and supplied all the principal seedsmen of Europe with seeds. It succeeds well in Scotland, even in the Highlands.

Properties and Uses. According to M. Thouin, the timber of *P. Laricio* is somewhat heavier than that of the *P. sylvestris* brought from Riga; but, being more resinous, it is less brittle and more elastic. Other authors assure us, on the contrary, says Baudrillart, that the wood of *P. Laricio* has neither the strength nor the elasticity of that of *P. sylvestris*. Previously to the year 1788, the wood was only used by the French government for the beams, the flooring, and the side planks of ships; but, in that year, the administration of the marine sent two engineers to examine the forests of Lonca and Rospa in Corsica, in which abundance of trees were found fit for masts. After this, entire vessels were built with it: only it was found necessary to give greater thickness to the masts, in order to supply its want of strength and elasticity. The thickness of the sap wood in *P. Laricio* is greater than in most other species of pine; but the heart wood is found to be of very great duration. In Corsica, it is employed for all the purposes for which it is used, when of 36 or 40 years' growth. It is easily worked, and is used both by cabinet-makers and sculptors in wood; the figures which ornament the heads of vessels being generally made of it. In Britain, the tree hitherto can only be

considered as being one of ornament; and, as such, it deserves to be planted extensively for its very regular and handsome form, and the intensely dark green of its abundant foliage. It also deserves planting on a large scale as a useful tree, on account of the great rapidity of its growth. In the low districts of Britain, it might probably be a good substitute for *P. sylvestris*.

Statistics. In the Environs of London. In the Horticultural Society's Garden, 12 years planted, it is 25 ft. high; at Muswell Hill, 8 years planted, it is 16 ft. high; in the Hackney arboretum, from 25 ft. to 30 ft. high; at Syon, 40 ft. high; at Kew, the tree figured in our last Volume, which is between 80 ft. and 90 ft. high.—North of London. In Bedfordshire, at Woburn Abbey, 7 years planted, it is 10 ft. high. In Berkshire, at White Knights, 37 years planted, it is 60 ft. high; at Droghda, 20 ft. high. In Essex, at Audley End, 7 years planted, it is 9 ft. 6 in. high. In Hertfordshire, at Cheshunt, 4 years planted, it is 8 ft. high. In Staffordshire, at Trentham, 6 years planted, it is 16 ft. high. In Suffolk, at Ampton Hall, 12 years old, it is 10 ft. high.

In Foreign Countries. In France, in the Jardin des Plantes, 55 years planted, it is 80 ft. high, the diameter of the trunk 2 ft. 6 in., and of the head 40 ft.; at Fromont, in the garden of M. le Chevalier Soulange-Bodin, it is 42 ft. high, the diameter of the trunk, at 6 ft. from the ground, 1 ft. 4 in.; in Brittany, at Barres, 12 years planted, it is 24 ft. high; at Nantes, in the nursery of M. Neerier, 15 years planted, it is 25 ft. high; in the Botanic Garden at Metz, 18 years grafted, it is 24 ft. high; at M. Brunel's, at Avranches, 20 years planted, it is 40 ft. high; in the Park at Clerveau, 42 years planted, it is 78 ft. high, the diameter of the trunk 1 ft. 6 in., and of the head 32 ft. In Hanover, at Harbecke, 10 years planted, it is 16 ft. high.

Commercial Statistics. Plants, in the London nurseries, are 1s. 6d. each; and at Bollwyller, 1 franc; but, if there were a demand for them, they would doubtless be procured at 30s. or 40s. per thousand.

‡ 8. *P. (L.) AUSTRIACA* Höss. The Austrian, or black, Pine.

Identification. Höss Anleitung, p. 6.; Lawson's Manual, p. 338.

Synonymes. *P. nigricans* Hort.; *P. nigrescens* Hort.; schwarz Föhre, Ger.

Engravings. Fig. 2085., showing the bud of a plant of two years' growth in the Horticultural Society's Garden.

Spec. Char., &c. Sheath with from 3 to 5 rings, at first of a clear ash grey, then becoming reddish, afterwards darker, and at last black. Leaves from 2 in. to 5 in. long; seldom, and but little, twisted; when young, erect; when older, standing out, and curved towards the twig; outer surface half round, dark green, glossy, and with a sharply serrated margin; inner surface nearly even, but slightly dotted along the ridge; points prickly, of a yellowish brown or fawn colour. Buds large, the leader often from 1 in. to 1½ in. long, ovate, with a long point. Scales dark brown, thinner at the margin and point, and furnished with whitish fringe; the lower ones curving back from the bud; the inner ones collapsed, and incrustated with white resin. Flowers produced about the end of May. Male catkins on short peduncles, oblong, cylindrical, round, or bluntly pointed, becoming conical after arriving at maturity, placed many together in verticillate bundles round the bottom of the young shoots. The female catkins two or three, or occasionally more, together, with rather long peduncles from the extremity of the young branches; round-oblong, erect, and dark red; becoming, in July, about ½ in. long, and ¼ in. broad; elliptical, and assuming a reddish brown colour. The cone does not arrive at maturity till October in its second year; it is conical, rounded at the base, 2 in. or 3 in. long, pointing horizontally, or nearly so; of a light yellow brown, polished, and shining. Seeds very closely resembling those of *P. Laricio*; and the cotyledons 6 or 8, as in that species. Trunk cylindrical. Bark very thick, of a blackish ash-green, marked with reddish brown spots. Scales deeply and longitudinally cleft; the fissures of a uniform reddish brick-colour, lighter than that of *Picea pectinata*. The branches are produced in regular whorls, at first inclined upwards towards the trunk, then spreading horizontally, and finally drooping at the extremity. In full-grown trees, the top becomes flat and spreading to a great extent. The bark of the shoots of the current year is of a greenish yellow, regularly and deeply raised by the insertions of the leaves, furrowed, and shining. (*Höss's Gemeinfaßliche Anleitung, &c.*, p. 8.; and *Lawson's Manual*, p. 339.)



2085

Geography and History. *P. austriaca* grows naturally in Austria, in the Breima Forest (Wienerwald), the Banate, upon the Demoglet, near Medadia; and, in the neighbourhood of the Snowy Mountains, it grows at higher altitudes than *Picea pectinata*. It prefers a deep, dry, calcareous sand;

but it will succeed in any soil, provided it is loose; and it even loves a moist soil, if not too wet. It thrives best in situations having a southern aspect. This pine was first introduced into Britain by Mr. Lawson of Edinburgh, in 1835. The seeds were sown in that year, on light sandy soil; and, at the end of the first season, the plants were twice as large as those of *P. sylvestris* sown at the same time in the same soil; and they had remarkably large deep-penetrating roots. (*Man.*, p. 339.)

Properties and Uses. The sap wood of *P. austriaca* is said by Höss to be of a whitish yellow, and the heart wood of a rusty yellow; the latter being very resinous, strong, and tough. It is much valued in Austria, when kept dry; and is said to surpass even the larch in resisting the injurious effects of water, or of alternate moisture and dryness. It is used by joiners, coopers, &c., and makes excellent fuel. When burned, the flames, on account of the resin contained in the wood, produce a very dense black smoke; and, where lampblack is the object, it is very productive of that substance. The wood is preferred to that of the beech for charcoal; and the roots afford splinters for torches. Among all the native pines of Austria, this one is said to afford the greatest quantity of turpentine.

Commercial Statistics. Price of plants, in Lawson's Nursery, Edinburgh, 10s. a thousand for one-year's seedlings, and 20s. for two-years' seedlings.

29. *P. (L.) PALLASIANA* Lamb. Pallas's, or the Tartarian, Pine.

Identification. Lamb. Pin., ed. 2, 1. t. 5; Lawson's Manual, p. 330.

Synonymes. *P. taurica* Hort.; *P. tatárca*, in the Hammersmith Nursery in 1797; *P. maritima* Pall.

Ind. Taur. (according to a specimen in Mr. Lambert's herbarium); *P. Pinca* Habl. *Taur.*, p. 97;

P. halepensis Bieb. *Fl. Taur. Cauc.*, 2. p. 408. (exclusive of the synonymes, except those of Pall.

and Habl.); *P. Laricio* Bieb. *Fl. Taur. Cauc. Suppl.*, 3. p. 623. (exclusive of the synonymes, except

those of Pall. and Habl.); *Tzaam* in the Tartar language.

Engraving. Lamb. Pin., ed. 2, 1. t. 5; our *Fig.* 2086. and 2088., of the natural size, from living specimens received from A. Lambert, Esq., taken from his

trees at Boyton; and the plate of this tree in our last Volume.

Spec. Char., &c. Leaves in pairs, very long, erect, rigid, channeled; sheaths

very short. Crest of the anthers roundish, convex repand. Cone ovate-oblong often curved. Scales slightly tuberculate, and terminated by a very small prickle. (*Lamb.*) Bud (*fig.* 2086.) $\frac{3}{4}$ in. to $1\frac{1}{2}$ in. long, and from $\frac{1}{2}$ in. to 1 in. broad; ovate, and pointed, with the sides concave, like those of *P. Laricio*, but much larger. Leaves (see *fig.*

2088.) from 4 in. to 7 in. or 8 in. in length; sheath from $\frac{1}{2}$ in. to $\frac{3}{4}$ in. in length. Cones from 4 in. to 5 in. in length, and from $1\frac{1}{2}$ in. to $1\frac{3}{4}$ in. in breadth at the widest part; ovate-oval, acuminate, horizontal in their direction, and slightly incurved at the extremities, which point downwards. Scales as in those of *P. Laricio*, but larger. (From specimens received from Mr. Lambert, White Knights, and the Glasnevin Garden, in August, 1837.)

Varieties. We can readily conceive that *P. L. Pallasiana*, like every other variety of *P. Laricio*, is liable to sport; and, accordingly, of the trees possessed by Mr. Lambert, one has the cones straight and short, and another long and crooked. In the Glasnevin Botanic Garden, there are two trees of *P. Pallasiana*, which were planted in the year 1797, and are now



about 50 ft. high. They were received from the Hammer-smith Nursery, and marked in the garden with the name of *P. uncinata*; but, in 1834, cones were produced, when they were found to be those of *P. Pallasiana*. Both these trees, Mr. Nevin informs us, are equally robust and vigorous; but the one throws out its branches in the most grotesque and luxuriant manner, with a knotty stem, while the other has an elegant cypress-like form. Mr. Niven has sent us specimens with cones of both varieties; but the cones of these specimens do not appear to differ in the least. There is a tree in the Horticultural Society's Garden, considered there as the true *P. Pallasiana*, which has borne cones, and of which *fig.* 2089. is a portrait, to our usual scale; but it is evidently not the *P. Pallasiana* of Lambert, but rather some other variety of *P. Laricio* less different from the species. There is another tree in the same garden, marked *P. taurica*, which has not borne cones; and, though it differs somewhat in habit from the tree marked there *P. Pallasiana*, being more fastigiate, we have no doubt it will be found, when it comes to produce cones, to be some other slight variation of *P. Laricio*. In rare species, of every kind, it is very natural to take advantage of slight shades of

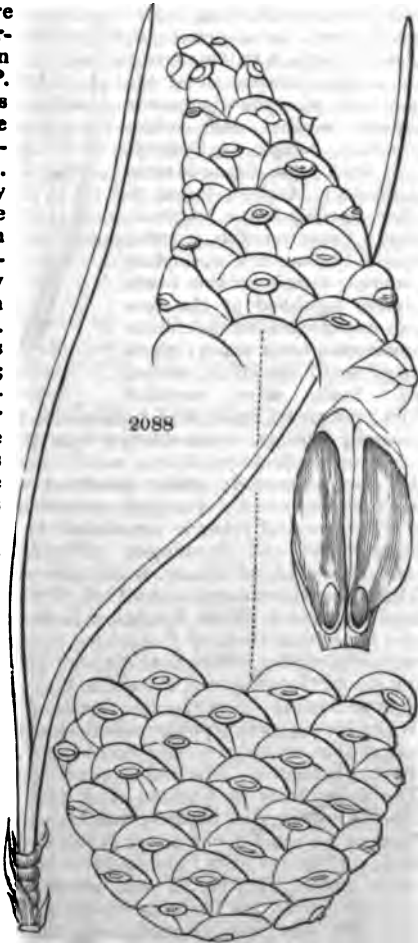

difference, and to hold them out as varieties, which, in species that are common, would be altogether neglected. For example, there might be many very distinct varieties selected from Scotch pine woods, quite as different from one another as the different varieties and subvarieties of *P. Laricio*; but, as *P. sylvestris* is a very common tree, no cultivator thinks it worth his while to bring its varieties or variations into notice.

Description. "A large tree, about the size of *P. sylvestris*, but much more spreading, sending out numerous large, declining, and horizontal branches from the summit to the base; the lower branches almost equalling the trunk itself in size. Bark cracked, rugged, brown, scaling off. Wood compact, white, brownish red in the centre, resinous, very knotty. Leaves in twos, crowded, erect, rigid, semi-cylindrical, glabrous, somewhat shining, light green; 5 in. long; roughly serrulated on the margin, canaliculate above, furnished at the apex with a sharp cartilaginous mucro; sheaths short, about $\frac{1}{2}$ in. long, round, covered externally with loose scales, membranous, and torn on the margin;

white, having at the base a lanceolate, long-pointed, persistent, indurated scale. Catkins terminal, sessile; bracteated at the base, with numerous lanceolate cuspidate scales; male catkins numerous, simple, cylindrical, $1\frac{1}{2}$ in. long, dense. Stamens monadelphous. Anthers linear, 2-celled, opening below longitudinally. Crest roundish, convex, repand. Pollen granular, sulphur-coloured; female catkins ovate, ternate, furnished at the base with numerous lanceolate, membranaceous, loose scales; green, erect, finally brownish, spreading. Scales short, roundish,

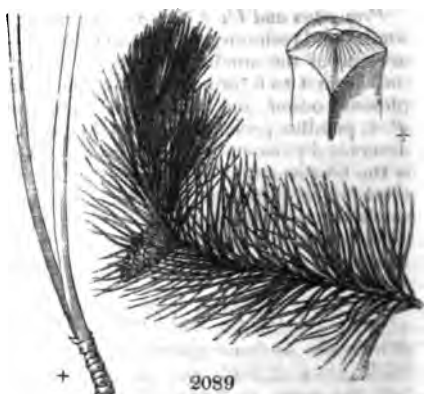

thick, marginate, imbricated backwards; keeled and convex above. Cone generally ternate, ovate-oblong; 5 in. long, sessile, 2 in. in diameter at the base, declinate-pendulous, ash-coloured, somewhat attenuated towards the apex, decurved; scales indurated, woody, dilated at the apex, trapezoidal, depressedly 4-angled; ash-coloured, elevated in the centre from a yellow conical tubercle terminated by a small spine. Seeds obovate; testa convex and crustaceous on both sides; wing slender, membranaceous, hook-shaped, oblong, acute, quite entire." (*Lamb. Pin.*, ed. 2., i. p. 14.) The chief circumstance in which *P. (L.) Pallasiana* differs from *P. Laricio*, judging from the trees at White Knights, is in the length of the cones: the leaves are also larger than those of *P. Laricio*; and, on the whole, the difference may be compared to that which exists between *Tilia europæa* and *T. e. grandifolia*, or the pin de Hageneau and the pin de Genève. At the same time, we think it right to observe that there is a tree of *P. Laricio* in the botanic garden at White Knights, which produces both straight and crooked cones, which, though longer than those generally borne by *P. Laricio*, are shorter than those of *P. (L.) Pallasiana*. The rate of growth appears to be the same as in *P. Laricio*. The finest trees in England of *P. (L.) Pallasiana* are, no doubt, those at Boyton, which, Mr. Lambert informs us, are between 60 ft. and 70 ft. high. There are a number of trees at White Knights, which are from 50 ft. to 60 ft. high, with trunks from 14 in. to 18 in. in diameter; but they are drawn up by other trees. They are in some places intermixed with trees of *P. Pinaster*, and the trunks are destitute of branches to the height of 20 ft. or 30 ft., so that the only way of recognising them from below is by observing the tortuous direction of their branches. There are trees at Dropmore, 25 ft. high. Mr. Lambert remarks, in a letter to us, dated July, 1837, that, though his trees produce plenty of cones annually, the seeds have never yet ripened.

Geography, History, &c. *P. Pallasiana* is confined to the central regions of the Crimea, forming considerable forests on the western declivity of the chain of lofty mountains which extend along the coast of the Black Sea. It was first introduced into England by Messrs. Lee and Kennedy of the Hammersmith Nursery, who raised a number of plants from seeds sent to them by Professor Pallas, from the Crimea, about 1790, and it was sold by them as *P. tatarica*. Of these plants, some were planted at Boyton, about 1793, of which a few survive, and form trees between 60 ft. and 70 ft. high, although the soil on which they grow is scarcely 2 in. thick, on a bed of solid chalk. About the same time, from 60 to 70 plants were planted at White Knights, by the Duke of Marlborough, in good loamy soil, 20 or 30 of which still exist, and are from 50 ft. to 60 ft. high; but, being crowded in a wood of indigenous and other free-growing trees, they have not assumed handsome shapes; and, indeed, there are only branches on their upper extremities.

Properties and Uses, Soil, &c. According to Professor Pallas, the wood is very knotty and resinous, and very durable, but difficult to form into good planks, on account of the number of its knots; the largest beams obtained from it being only from 4 to 6 yards in length. The resin is produced in vast quantities, has a pleasant odour, and is employed as incense in Catholic churches, like that of *P. s. pumilio*, procured from Moldavia. As an ornamental tree, *P. Pallasiana* deserves a place in every collection. "Of all pines," says Mr. Lambert, "this is the best adapted for thin chalky soils, and maritime situations." Plants, in the London nurseries, are 10s. 6d. each; but, as the tree has not yet ripened seeds in this country, they are not common. When a greater demand takes place, seeds may easily be procured through the garden established by the Russian government at Odessa.

‡ 10. *P. (L.) PYRENAÏCA* Lap. The Pyrenean Pine.

Identification. La Peyrouse Supp. Fl. Pyren.; Bon Jard., ed. 1837, p. 975; Lawson's Manual, p. 235. *Synonymes.* *P. hispánica* Cook's Sketches in Spain, 2. p. 237.; Pináster hispánica Resas di San Clemente; *P. penicillus* Lap. Hist. des Pl. des Pyrénées. *P. halepensis* major Ann. d'Hort. de Paris, 13. p. 187; Pin Nazaron, Pin pinceau, Fr. *Engravings.* Our fig. 2091., from a cone received from Captain Cook; fig. 2093., from a cone received from M. Vilmorin; fig. 2090., from a bud of the plant in the Horticultural Society's Garden; all of the natural size; and fig. 2092., to our usual scale, from a tree growing, in 1837, at Woodside, near Hatfield, the residence of John Church, Esq.

Spec. Char., &c. Leaves long, in tufts at the extremities of the shoots; branches dispersed, naked, scaly when young.



Cones conical, smooth, and a little recurved, seeds hard. (*Lap.*) The tree when young somewhat resembles *P. halepensis*, but when older it assumes a much higher stature, and a more pyramidal form. The cones are, like those of *P. halepensis*, on strong foot-stalks; but, instead of pointing downwards, they are always in a horizontal direction. The leaves are long and fine; but strong and upright, and arranged round the branches like the hairs of a camel-hair pencil, whence the name of pin pinceau. They are sometimes three in a sheath, on the young shoots. (*Ann. de la Soc. d'Hort. de Paris*, xiii. p. 186.) Captain Cook, who introduced this species in 1834, found it occupying the highest range of the extensive forests of the Sierra de Segura, in the south of Spain, where it overtops *P. halepensis*; and in a corresponding situation, in the vast forest region of the Sierra de Cuença, on the river Gabriel, in Upper Aragon, where it forms extensive forests; but La Peyrouse appears to have only found it in the Pyrenees. "This majestic pine is concentrated in the Pyrenees, between the river of Lasserre, and that of Cinca, in the valleys of Pin, de la Pez, and at Campo, where it is known by the name of pin nararon." It occupies a surface of nearly six square leagues, the greater part of which is in Aragon, and the other part in France. It is neither isolated, nor in masses; but grows mingled with other kinds of pines, in ancient woods, which are almost inaccessible from the elevation at which they grow. Before the revolution, a company bought the wood of Cinca, and had excavated a subterranean road, to facilitate the removal of the trees. The revolution put a stop to this project; but the opening of these works is still to be seen at the Port de la Pez." (*Hist. des Plantes des Pyr.*) M. La Peyrouse at first supposed this pine to be the same as *P. Laricio*, which it greatly resembles in



7 D 2

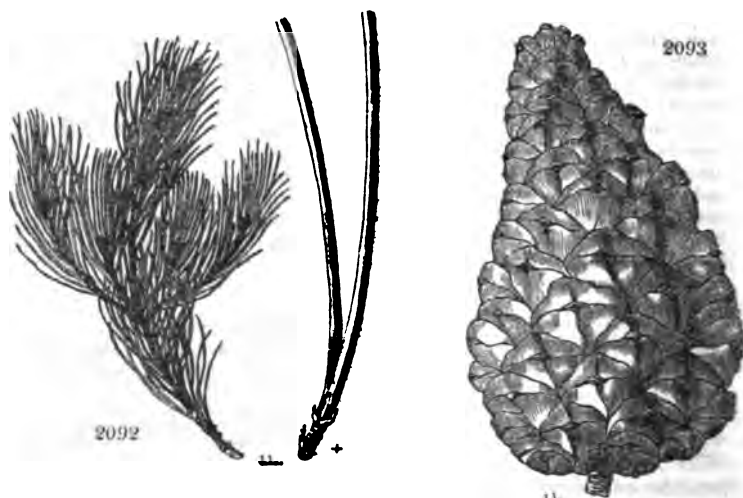

its general appearance. He afterwards called it *P. penicellus*, but, in his *Suppl.* he names it *P. pyrenæica*, which name Captain Cook proposes to change to *P. hispánica*, as the tree is chiefly found in Spain; and a French writer in *Annales d'Hort.* to *P. halepensis* major. Captain Cook states that this species is "quite hardy, of quick growth, and will, from its noble appearance, the beauty of its form, and the clear transparent colour of both the bark and foliage, be a vast acquisition to our park scenery. The timber is white and dry, being nearly without turpentine; but the cones exude a most delicious balsamic odour. The wood was formerly used by the Spanish government, in the arsenals of Carthagenæ and Cadiz, for the decks of ships; for which purpose regular depots were kept in the Sierra de Segura; and it was floated down to the respective ports by the rivers Segura and Guadalquivir. It is one of the species described in the book of Arab agriculture written by a Moor of Seville, in 1200, and translated by Banqueri." Besides the plants sent by Captain Cook to Woodside, the Horticultural Society's Garden, and Syon, there are also specimens at Newton and Belsay, in Northumberland; at Dropmore; at Carlton, near Darlington, in Durham; at Carclew, in Cornwall; and some other places.

‡ 11. *P. RESINOSA* Ait. The resinous, or red, Pine.

Identification. Ait. Hort. Kew., ed. 1., 3. p. 367., ed. 2., 5. p. 316.; Lamb. Pin., ed. 2., t. 13.; Willd. Sp. Pl., 4. p. 496.; Mart. Mill., No. 4.; Pursh Fl. Amer. Sept., 2. p. 642.; Hayne Desc., p. 173.; Lawson's Manual, p. 347.; Bon Jard., 1837, p. 975.; Lodd. Cat., ed. 1836.
Synonymy. *P. canadensis bifolia cœnis mediis ovatis Du Ham. Arb.*, 2. p. 125.; *P. rubra Michx. N. Amer. Syl.*, 3. p. 112.; Norway Pine, in Canada; Yellow Pine in Nova Scotia; le Pin rouge de Canada, Fr.
Engravings. Lamb. Pin., ed. 2., 1. t. 13.; Michx. N. Amer. Syl., 3. t. 134.; our fig. 2096., to our usual scale, with a male catkin (m) of the natural size; and figs. 2094. and 2095., of the natural size; all from Dropmore and White Knights specimens.

Spec. Char., &c. Bark red. Leaves in pairs, 4 in. or 5 in. long. Cones of a reddish brown, ovate-conical, rounded at the base, and half the length of the leaves; scales dilated in the middle, and unarmed. (*Michx.*) Buds (fig. 2094.), in the White Knights specimen, $1\frac{1}{2}$ in. long, and $\frac{2}{3}$ in. broad; ovate, acuminate, concave on the sides, with a long point, as in *P. Laricio*; but reddish brown, and very resinous. Leaves (fig. 2095.) from 5 in. to 6 in. long, straight, stiff, and yellow at the tip; sheath from $\frac{1}{2}$ in. to 1 in. long, white, lacerated, and becoming short and dark with age. Cone 2 in. long, and $1\frac{1}{2}$ in. broad, ovate-conical, brownish red, sessile, or with very



short footstalks; scales $\frac{1}{4}$ in. long, and $\frac{1}{2}$ in. broad. Seeds small; with the wings $\frac{1}{2}$ in. long. The leaves are thickly set, and inclined towards the shoot, and much lighter and more glaucous than in *P. Laricio* and its varieties, in which the foliage is of a darker green than it is in any other species of *Pinus*. The shoots are much more naked, and the whole tree is more open and lighter; and the large and small branches are straighter and more distant than in *P. Laricio*; the plant is also of much less vigorous growth in British gardens. The cones, in Michaux's figure, and also on the trees at White Knights, bear a good deal of resemblance to those of *P. Laricio*; which induced Loiseleur Deslongchamps to consider Michaux's plant as identical with that species; but, we think, if he had seen the cones and trees at White Knights, he would have been of a different opinion. We have sent him a specimen. We acknowledge, however, that both the foliage and the cones, and even the tree altogether, bear a close

general resemblance to *P. Laricio*; but the different form and colour of the scales, the lighter tinge of the foliage, and, above all, the much more delicate constitution of the tree, appear sufficient to justify us in retaining it as a distinct species. We are certain that the trees at White Knights are the true *P. rubra* of Michaux; because they were raised by Messrs. Loddiges from seeds of *P. rubra*, sent to them by Bartram of Philadelphia. We have also, since the above was written, received cones and leaves from Mr. M' Nab, jun., which were gathered by him in Upper Canada, in August, 1834, from trees which had been blown down, and which measured upwards of 70 ft. in length.

Description. A tree, according to Michaux, which, in America, rises from 70 ft. to 80 ft., with a trunk about 2 ft. in diameter, and retaining nearly the same bulk for two thirds of its height. The bark is of a clearer red than that of any other pine in the United States; and by this the tree may always readily be distinguished. The leaves are 5 in. or 6 in. long, of a dark green, two in a sheath, and collected in bunches at the extremity of the branches, like those of the pinaster; instead of being distributed regularly over them, like those of *P. inops* and *P. sylvestris*. The female catkins are of a dark blue, when they first appear;

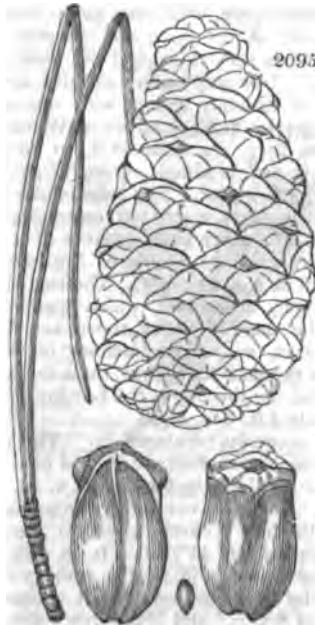

and the cones, which are quite destitute of prickles, are about 2 in. long, rounded at the base, and abruptly pointed. The concentric circles of the wood are very close; and the wood, when wrought, exhibits a fine compact grain. It is very heavy; and this, according to Michaux, arises from the quantity of resinous matter with which it is impregnated. The finest trees of this species in England are at White Knights and Dropmore; at both which places they are from 20 ft. to 25 ft. in height, and produces cones, in general, every other year. The habit of the tree, at both places, is very well represented by fig. 2097., which is the portrait of a tree at Dropmore (to a scale of 1 in. to 6 ft.), taken in August, 1637. The tree in the Hackney arboretum, which was raised at the same time as those at White Knights, and of the identity of which, from the buds and leaves, there can be no doubt, not thriving in the London smoke, is only 4 ft. 3 in. high.

Geography, History, &c. The elder Michaux first observed the red pine near Lake St. John, in Canada, in n. lat. 48°; and his son did not find it extend farther south than Wilkesborough, in Pennsylvania, in lat. 41° 30'. It is rare, the latter observes, in all the country south of the river Hudson; but it abounds in Nova Scotia; and Mackenzie states that he saw it beyond Lake Superior. It is not found in immense forests, but occupies small tracts of a few hundred acres in extent, alone or mingled with the white pine; growing only in dry sandy soils. Mr. M'Nab only found this species in the neighbourhood of Kingston, and on the banks of the Genesee in the state of New York. He was informed, however, that it was abundant in the interior of the country, at a distance from the rivers and lakes. This species is mentioned, in the *Traité des Arbres, &c.*, of Du Hamel, published in 1755, as the pin rouge de Canada; but, as he says he received the description of it from M. Gaultier, who was conseiller au conseil supérieur, et médecin du roi, at Quebec, it is probable that living specimens were not sent to France. It was introduced into Britain by Hugh Duke of Northumberland, in 1756; and Mr. Lambert, writing in 1804, mentions that the greatest number of trees in England were then at Syon House. He also found one at Pain's Hill, and mentions others at Kenwood. The whole of these trees seem to be dead, or cut down; for we could not find one at Pain's Hill, and there are none at Syon or Kenwood. About the end of the last century, Messrs. Loddiges raised nearly 100 plants of *P. resinosa*, from seeds received from Bartram of Philadelphia; and nearly the whole of these were planted by the then Marquis of Blandford (the present Duke of Marlborough) at White Knights, where a number of them still exist, though they have been much injured by other trees; and they have borne cones for several years past.

Properties and Uses. The concentric circles of the wood of this tree, Michaux observes, are small, and it consequently exhibits a fine grain; and, being rendered heavy by the resinous matter with which it is impregnated, it is highly esteemed in Canada for its strength and durability. It is employed to furnish planks for the decks of ships, which are often 40 ft. long, without a single knot; and, stripped of its sap wood, it makes excellent pumps. It has also been used for the masts of ships; and Du Hamel (*Traité des Arbres*), and after him Michaux, mention that the mainmast of the St. Law-



rence, a ship of 50 or 60 guns, built by the French at Quebec, was made of it. The timber of this pine is sent to England, from the district of Maine and the shores of Lake Champlain. As an ornamental tree, this species is well deserving of cultivation. The price of plants, at New York, is 50 cents each.

App. i. *Doubtful Species, apparently belonging to § Laricio.*

P. canadensis bifolia, foliis brevioribus et tenuioribus, Du Ham. Arb., ii. p. 126.; *P. resinosa* N. Du Ham., v. p. 237. t. 71. f. 2.; and our fig. 2098. to our usual scale, and fig. 2099. of the natural size, both from the *Novœus Du Hamel*. Leaves in pairs, or three in a sheath, slender. Cones conical, erect, in twos, threes, or four, and sometimes in clusters; not half the length of the leaves; having their scales convex on the back, scarcely angular, depressed and umbilicate at the summit. (*Lois. Deslongchamps*.) There was, in 1812, a tree of this species growing in the garden of the Veterinary School at Alfort, about two leagues from Paris, which Loiseleur Deslongchamps states that he had known for more than 30 years, and which was not then more than 12 ft. high. The trunk is divided near the base into three large limbs, which rise obliquely, and are subdivided into numerous small branches, so as to form a large round bush. The trunk and limbs are covered with a rough cracked bark of a reddish brown; while the younger branches have a greyish bark, tolerably smooth. The leaves are in pairs or threes; they are slender, from 3 in. to 6 in. long, and are disposed in tufts at the extremity of the branches, or near the clusters of cones; leaving at least half or two thirds of each branch quite bare. The tree at Alfort does not appear to have borne any



male catkins; but the female ones are numerous: they are oval, reddish, and disposed in groups or clusters, of from 2 or 3 to 6 or 10, or even more, together. The female catkins stand straight out when in flower, and retain the same direction when in fruit. They ripen the second year, but remain on the tree for 4 years or more. They are about 2 in. long, and 1½ in. in diameter at the base, terminating in a sharp point; of a bright cinnamon-red colour; the swollen part of the scales is convex, a little angular, and depressed in the centre, where it is of a greyish colour. The seeds are nearly white, and much larger than those of *P. Laricio*. The wing, which is of the same colour, is ½ in. or more in length. The only specimen of this pine which Loiseleur Deslongchamps had met with in France was that above described at Alfort, where it was under the name of *P. halænsis*, though it differed materially from that species in various points, and particularly in having its cones pointing horizontally, instead of downwards. Du Hamel, in his *Traité des Arbres*, &c., published in 1755, gives a description of this species, which he says he received from M. Gaultier of Quebec. He calls it *P. canadensis bifolia, foliis brevioribus et tenuioribus, le petit pin rouge de Canada*; in opposition to *P. canadensis bifolia, cône médius ovatis, le pin rouge de Canada*, also received from M. Gaultier, and which is evidently the same as the *P. rubra* of Michaux. *P. resinosa* Ait.; as Du Hamel expressly mentions that its timber was used for the mainmast of the St. Lawrence; a fact also stated by Michaux. (See p. 2212.) He states that this pine was said to grow near Montreal, on the banks of the St. Lawrence.

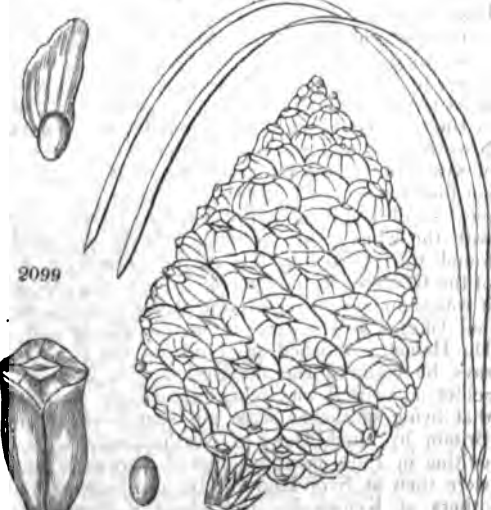

He says he received from M. Gaultier of Quebec. He calls it *P. canadensis bifolia, foliis brevioribus et tenuioribus, le petit pin rouge de Canada*; in opposition to *P. canadensis bifolia, cône médius ovatis, le pin rouge de Canada*, also received from M. Gaultier, and which is evidently the same as the *P. rubra* of Michaux. *P. resinosa* Ait.; as Du Hamel expressly mentions that its timber was used for the mainmast of the St. Lawrence; a fact also stated by Michaux. (See p. 2212.) He states that this pine was said to grow near Montreal, on the banks of the St. Lawrence.

§ iii. *Pinaster*.

Sect. Char. Leaves long, straight, and stiff, comparatively broad. Cones large, with rhomboidal, pyramidal terminations, pointed. Buds blunt-pointed, imbricated, with the scales turned back, woolly, and wholly without resin.

12. *P. PINASTER* Ait. The Pinaster, or Cluster, Pine.

Identification. Ait. Hort. Kew., ed. 1., 3. p. 367.; Lamb. Pin., 1. t. 9.; Mart. Mill., No. 2.; Lawson's Manual, p. 341.; Lodd. Cat., ed. 1836; Hayne Dend., p. 172.

Synonymes. *P. sylvêtris* *Lia. Spet. Reich.*, 4. p. 172; *P. maritima* *littora Du Ham. Arb.*, No. 4. t. 93, *Du Roi Herbik.*, ed. Pott., 2. p. 59; *P. maritima* *N. Du Ham.*, 5. p. 240; *P. sylvica* *Thore Prom. sur les Côtes de Gascogne.* p. 161.; *Pin de Bordeaux*, *Pin des Landes Engravings.* *Du Ham. Arb.*, No. 4. t. 93.; *Lamb. Pin.*, ed. 2. l. t. 9.; *N. Du Ham.*, 5. t. 72 and 72 bis t. 1.; our *fig.* 2105., to our usual scale; *figs.* 2100. and 2101., of the natural size, from Dropmore and Fain's Hill specimens; and the plates of this tree in our last Volume.

Spec. Char., &c. Leaves in pairs, rigid, very long. Cones conical, placed in whorls of 3, 4, or even as many as 8, together; rarely solitary, much shorter than the leaves; the backs of the scales forming each a rhomboidal pyramid, with two lateral angles, from which proceed ribs, terminating at the summit of the pyramid in a smaller pyramid, which has a hard point, more or less sharp, and of a grey colour. Crest of the anthers rounded. (*N. Du Ham.*, and obs.) Bud (*fig.* 2100.) from $\frac{1}{4}$ in. to $\frac{1}{2}$ in. long; and from $\frac{3}{8}$ in. to $\frac{1}{2}$ in. broad; straight-sided, cylindrical, pointed, imbricated, with the scales turned back; white and woolly, but never resinous; surrounding buds few and small. Leaves (see *fig.* 2101.) from 6 in. or 8 in. to 1 ft. in length, slightly soirated on the margins; sheaths from $\frac{1}{2}$ in. to $\frac{3}{4}$ in. in length; imbricated, scarcely rigid; pale green or whitish at first, and becoming at last black. Cones from 4 in. to 6 in. in length, and from 1 $\frac{1}{2}$ in. to 2 $\frac{1}{2}$ in. wide at the broadest part; light brown, and shining; scales from 1 in. to 1 $\frac{1}{2}$ in. in length, and from $\frac{1}{2}$ in. to $\frac{3}{4}$ in. in breadth at the widest part; terminating in a regular pyramid; rhomboidal at the base. The summit consisting of a smaller rhomboidal pyramid, of an ash-grey colour, very hard, and with a small sharp point, more particularly in the upper part of the cone. Seeds oblong, and measuring, without the wing, upwards of $\frac{3}{8}$ in. in length, and nearly $\frac{1}{2}$ in. in breadth; with the wing above 1 $\frac{1}{2}$ in. in length; wing nearly $\frac{1}{2}$ in. in breadth. Cotyledons 7 or 8. The tree flowers, near London, in the beginning of June; in the north and west of France, in May; and on the Landes of Bordeaux, in April.



Varieties. The extensive geographical range of this tree has given rise to many varieties, though we have seen but very few that can be considered truly distinct. In the *Nouveau Du Hamel*, only one is mentioned; but it is added, that, in the Landes of Bordeaux, in the sandy downs along the sea coast, where the trees send down their taproots to a great depth, some are to be found which produce clusters of cones from 30 or 40 to 80, or even 100, in a cluster. This is stated by Loiseau Dealongchamps, on the authority of Dr. Thore of Dax, who adds that this luxuriance of vegetation is not constant; for the same trees which have borne so many cones in one year, are found, in other years, with very few, or none; it cannot, therefore, be considered as a variety. The pinaster appears also to be indigenous to, or to have been introduced into, several ultra-European countries; and plants raised from seeds received from these countries have had names given to them in British gardens, though hardly, as we think, meriting that distinction. We shall, however, give all the varieties of which we have seen plants, and leave the reader to judge for himself.

2 P. 2 *escarèmus*, *P. escarèna* *Risso.* — The leaves are of a paler green than those of the species, but they are equally long and strong. The cones are shorter, and more ovate. This is the most distinct and handsome variety of pinaster that we have seen: it was first introduced into Britain by the Earl of Aberdeen, in 1825; the tree having been pointed out to His Lordship in that year, by M. Risso, at Nice, as growing, though rather sparingly, in the mountains, about 12 or 15 miles from that city. From seeds brought to England by Lord Aberdeen, plants were raised; and one presented by him to Lord Grenville bore cones in 1836, and is now (1837) 17 ft. high: one presented to the London Horticultural Society, after being 8 years planted, is now 11 ft. high, but has not yet borne cones.

‡ P. P. 3 *Lemoniana*, *P. Lemoniana* Benth Hort. Transac., vol. i., second series, p. 509. pl. 20.; and our fig. 2102. to our usual scale, and fig. 2101. to the natural size. — This is also a very distinct variety, but quite the opposite of the last; being a stunted bulky plant, with zigzag, close, and twiggy branches; and standing apparently in the same relation to *P. Pinaster* that *P. (s.) pumilio* does to *P. sylvestris*. In a very distinct account of this variety by Sir Charles Lemon, published in the *Horticultural Transactions*, as above referred to, he characterises it as follows: —“ In foliage,

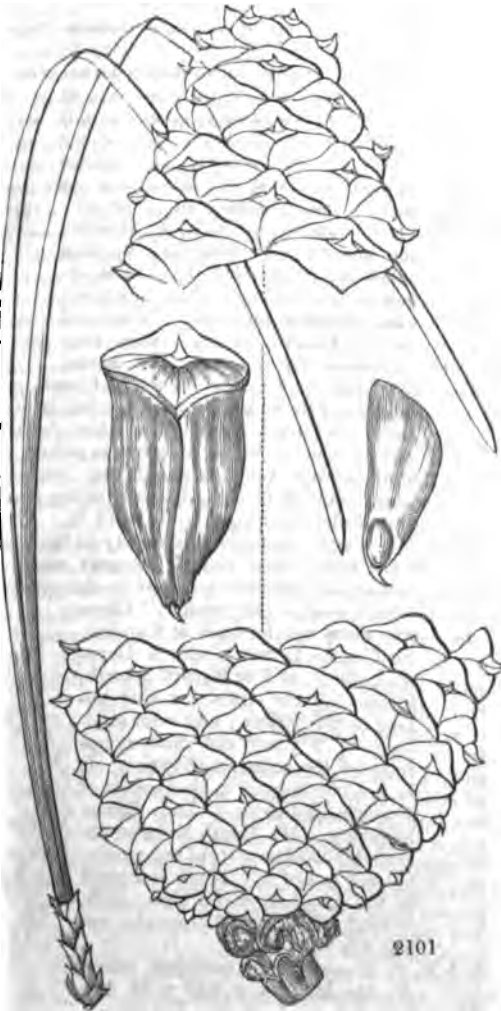

it is similar to the pinaster; but it differs in the general habit of the tree, and in the form and position of the cones. In the common pinaster, the cones, of which there are generally 3 or 4 together, are situated behind the shoots of the whorl, and, in the mature state, point backwards. In this obscure species the cone is single, and it universally occupies the place of the leading shoot, the side shoots being behind it. The necessary consequence of this mode of growth is, that the tree can have no regular leader, but each year one of the side shoots strengthens, and continues the growth for the ensuing season; the year following, the same process is repeated in another direction, giving the stem of the tree a zigzag appearance, which it never entirely loses.” The general appearance of the tree is that of a short bushy pinaster; though there is nothing dwarfish or dis-

eased in its appearance, nor does it exhibit any peculiarities of constitution, to which other pines are not subject. Occasionally, like the pinaster and Scotch pines, it kills itself by an exuberant bearing of cones; and it then assumes a very extraordinary aspect, reminding one, Sir Charles Lemon observes, of the groups of little wooden birds, or popinjays, perched on the ends of sticks, at which the people of Holland and Belgium shoot for prizes with bows and arrows. The foliage, when this takes place, drops off, and the tree is reduced to a collection of dry sticks, each terminated by a cone. The largest



tree that Sir Charles Lemon had seen, measured, in 1833, 44 in. in girth at 4 ft. from the ground, after being planted 35 years. Mr. Booth, in 1837, informed us that the two largest trees of this variety that he knew of, grew in rather an exposed situation between Carclew and Mylor Bridge, and that they were about 30 ft. high, diameter of the trunk about 15 in., and of the head from 15 ft. to 18 ft. When of this size, Mr. Booth considers this variety to be a very graceful tree "the head being round, compact and bushy, and presenting an agreeable contrast to the pyramidal head of the Scotch pine, or the pinaster." There are many smaller trees at Carclew, Sir Charles Lemon's seat in Cornwall, which, at 8 or 9 years' growth, assume all the characters that belong to the variety; and even seedlings of 3 years' old show symptoms of the same peculiarities. It is not uncommon in the woods of Carclew, and those of Lady Basset adjoining. Mr. Booth has also observed it in other parts of the county, but not out of it. There is a plant in the pinetum at Carclew which, in 1837, after being 6 years planted, was 6 ft. 6 in. high.

‡ *P. p. minor*; *P. maritima minor* *N. Du Ham.*, v. p. 242 t. 72. bis, f. 1., and our fig. 2104.; Pin Pinsot, Pin de Mans, Pin à Trochet.—

This variety, which is chiefly distinguished by the somewhat smaller size of its cones, being from 3½ in. to 4 in. long, and 1½ in. broad, is said by Bosc to be produced by a colder climate, and to abound on the west coast of France, especially on the barren sands in the neighbourhood of Mans; and to be hardier than the species.

It is found in the Landes of Bordeaux, growing along with *P. Pinaster*. There is a specimen of this variety in the Jardin des Plantes, as well as of *P. Pinaster*, known there as *P. maritima major*; and a considerable quantity of *P. maritima minor* has been sown in the Forest of Fontainebleau. Judging from the specimens with cones which have been sent us from different parts of the country, this

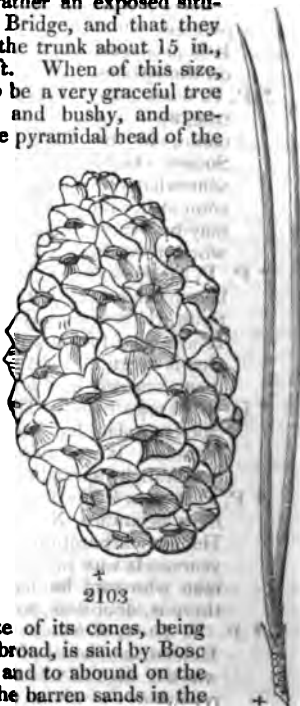

variety appears to be frequent in England. From White Knights, we have received specimens with cones not 3 in. in length. It is said in the *Nouveau Cours d'Agriculture, &c.*, that five faggots of the wood of this variety will burn as much lime as eight faggots of oak.

‡ P. P. 5 *foliis variegatis*.—This variety was discovered by Mr. Cree, the founder of the Adlestone Nursery, towards the end of the last century; and the original plant is still in the grounds occupied by his son, the author of *Hortus Adlestonensis*. There is a tree in the Horticultural Society's Garden, 12 years planted, which is 12 ft. high. It is propagated by inarching on the species.

‡ P. P. 6 *maritimus*.—There is a tree, 25 ft. high, bearing this name, in the Horticultural Society's Garden; but, though somewhat more fastigiate than some other pinasters there, it may be a mere variation, not worth recording as a variety.

‡ P. P. 7 *chinensis*.—The tree bearing this name in the Horticultural Society's Garden is 14 ft. high, after being 10 years planted. It was raised from seeds imported from China by Mr. Reeves. The tree is erect, and not so spreading as the species is in general; but it can scarcely be worth while to keep it distinct as a variety.

‡ P. P. 8 *nepalensis*.—The tree bearing this name in the Horticultural Society's Garden was, in 1837, 14 ft. high, after being 12 years planted. It was raised from seeds sent home by Dr. Wallich, and is a branchy spreading tree, with narrower cones than the species.

‡ P. P. 9 *noveus holländicus*; *P. Novæ Hollandiæ Lodd. Cat.*, ed. 1836; *P. nova zelandica*, No. 28. in the arboretum at Kew.—The tree in the Hackney arboretum is 10 ft. high, and has borne cones for several years. It was raised from seeds received, in 1816, from a gentleman who said he had them from New Zealand, though in this there is, doubtless, some mistake.

‡ P. P. 10 *st. helenicus*.—A plant with this name, imported from St. Helena, and which, in 1837, in the collection at Hendon Rectory, was 6 ft. high in a pot, had leaves full 7 in. long, and $\frac{1}{2}$ in. broad, and remarkably strong and thick, with the leaves of the preceding year pointing downwards, like those of *P. Sabiniæna*. If this variety should be the same as the St. Helena pinaster in Loddiges's arboretum, the luxuriance of its foliage will be greatly diminished when the tree grows old; for the last tree in the line of pines in the Hackney arboretum, which was imported from St. Helena in 1816, is now (1837) 25 ft. high, and not distinguishable either in leaves or cones from the common pinaster.



‡ P. P. 11. *Massoniæ*us, *P. Massoniæ*s Lamb., 2 ed., 1. t. 8., to be noticed hereafter, Professor Don considers as only *P. Pinaster*, which we think very probable.

The only varieties of pinaster which we think worth cultivating are *P. P. escarè*us; and *P. P. Lemoniæ*us, and, for those who like variegated plants, *P. P. fô*liis variegâtis.

Description. A large, handsome, pyramidal tree, varying from 40 ft. to 60 ft. in height, according to soil and situation; readily distinguished from all other pines by the large clustered masses of foliage, of a much lighter green than that of *P. Laricio*, which alternate with naked spaces, on the extremities of its branches. The trunk, even of young trees, is clothed with a deeply furrowed coarse bark, especially towards the base, where it generally inclines to one side, from the weight of the top, when the tree is quite young. The branches are in regular whorls, and invariably turn upwards. The groups of cones point outwards in star-like clusters; whence the name of pin aster, or star pine. The male catkins, which are, on dry soils, produced when the tree is only 6 or 8 years old, are of a yellow or fawn colour, sometimes slightly tinged with red; they are more numerous, generally occupying a space of from 4 in. to 6 in. or more in length, round the base of the shoot of the current year. When these male catkins drop off, the space they occupied is left bare; and hence the alternation already mentioned, of tufts of foliage and bare places, on the extremities of the branches;

and which are so much more conspicuous on this pine than on any other European species, from the greater number of catkins produced, and the greater length of the leaves. The female catkins appear in whorls on the extremities of the shoots of the current year; and are at first purple, but afterwards change to green, and, when they attain maturity, in the autumn of the second year, become of a rich shining brown. The pyramidal termination to the scales of the cones is always much larger, and more prominent, on the upper side of the cone than on the under side, and on that side of the tree which is exposed to the sun, than on that which is in the shade. There is a more decided taproot in this pine than in any other European species; and, where the soil is dry and sandy, it descends perpendicularly into it, like the root of a broad-leaved tree. In proportion as the perpendicular roots are stronger than those of other pines, the horizontal roots are weaker; and hence, in the case of transplanted trees, from the weight of the head, produced by the dense mass of long foliage, the stem is generally inclined to one side; and when, after two or three years, it begins to grow erect, a curvature appears close above the root, which remains visible even in old trees. The rate of growth is very rapid; plants, in 10 years from the seed, attaining the height of 10 ft. or 12 ft., and, in twenty years, the height of 30 ft., in the climate of London. The wood is in thick layers, soft, and not of great duration. The finest pinaster in the neighbourhood of London is



in the gardens of Fulham Palace; and the next largest are at Syon, Pain's Hill, and Whitton. The tree at Fulham is above 80 ft. high; one of those at Whitton is 80 ft. high, with a trunk 4 ft. in diameter, clear of branches to the height of 40 ft. Several at Pain's Hill, and some at Syon, are above 60 ft. high. The largest pinasters which we have heard of in England are at Westwich House, Norfolk, the seat of J. Peters, Esq. They were planted in 1702, and in 1809 several of them were measured by N. Kent, Esq., and found to be upwards of 80 ft. high, and to contain about eight loads of timber each. (See *Trans. Soc. Arts*, vol. xxviii. p. 42.)

Geography, History, &c. The pinaster is indigenous to the south of Europe, and to both shores of the Mediterranean; to Greece, the west of Asia, the Himalayas, and, as it would appear, even to China. It may be doubted, however, whether it has not been carried from Europe to the latter country. It is not indigenous to the north of France or Germany, and is, perhaps, most abundant in Spain, and on the shores of the Mediterranean. It never thrives, except in deep sand or sandy loam; and it is said to perish when planted in calcareous soil. The pinaster was introduced into England in 1596, by Gerard; and one of the oldest trees still existing is in the gardens of the episcopal palace at Fulham, where, as we have seen above and in p. 43., it was, in 1835, 80 ft. high. The pinaster has since been very extensively planted in Britain, as an ornamental tree; and, in some parts of Hampshire and Norfolk, plantations of it have been formed on a large scale for useful purposes. In Hampshire, it has generally failed, from the soil being peaty, wet at bottom, shallow, and hard, or the subsoil being chalk. In Norfolk, on the other hand, where it has been planted in deep sand, the success has been very different. At Westwich House, in that county, already mentioned, the pinaster began to be planted in 1702; and many trees, still existing there, are from 70 ft. to 80 ft. high, with trunks proportionately thick. An account of the pinaster plantations at this place, taken in 1809, is given in the *Transactions of the Society of Arts*, vol. xxviii., by which it appears that J. B. Peters, Esq., the father of the present proprietor, had raised above 200,000 plants from seeds gathered from his own trees. He had planted altogether upwards of 500 acres, through which he had formed a drive of five miles in length. The situation is bleak, and the soil sand, covered with heath, on a subsoil of coarse hard gravel, or dead yellow sand. Nevertheless, on this soil the plants grow so rapidly, that, in 8 or 9 years after planting, their trunks are from 10 in. to 20 in. round, and some have occasionally made shoots of 5 ft. in length in 2 years. They are planted at 7 ft. apart every way, and remain unthinned and unpruned till they attain a circumference of 2 ft. or 3 ft. Such is the vigour with which these trees grow, that, on the steep side of a hill, the roots have been observed to emerge from the soil, creep along its surface for 2 ft. or 3 ft., and then strike into the soil again. (*Trans. Soc. Arts*, vol. xxviii. p. 42.) In Scotland and Ireland, the pinaster has only been planted as an ornamental tree; and it thrives, in these countries, in low situations, and near the sea. In France, it cannot be cultivated with a view to profit, to the north of Paris; and, even in that latitude, it is sometimes destroyed by severe winters: for example, in 1788, when a severe frost killed some large trees on the estate of Malesherbes. It abounds in Switzerland, where its timber is said to be used in forming shingles; and it is planted as an ornamental tree in Germany, but scarcely thrives north of Hamburg.

The most remarkable fact in the history of this tree is, the great use which has been made of it in France, in covering immense tracts of barren sand. This mode of improvement was first commenced in 1789, by M. Bremonnier, of the Administration of Forests, who published a memoir on the subject in the year 1800, of which we shall make a very brief abridgement. There are very extensive downs in several countries of Europe; and the most remarkable in France are those between Dunkirk and Nieuport, between Calais and Boulogne, and between the rivers Adour and Gironde. Bremonnier con-

menced his operations in the Gulf of Gascony, in 1789. The downs there are composed of drifting sands, covering 300 square miles. Bremon-tier compares the surface of this immense tract to a sea, which, when agitated to fury by a tempest, had been suddenly fixed, and changed to sand. It offered nothing to the eye, but a monotonous repetition of white wavy mountains, perfectly destitute of vegetation. In times of violent storms of wind, the surface of these downs was entirely changed; what were hills of sand often becoming valleys, and the contrary. The sand, on these occasions, was often carried up into the interior of the country, covering cultivated fields, villages, and even entire forests. This takes place so gradually (by the sand sweeping along the surface, and thus raising it, or falling from the air in a shower of particles, so fine as to be scarcely perceptible), that nothing is destroyed. The sand gradually rises among crops, as if they were inundated with water; and the herbage and the tops of trees appear quite green and healthy, even to the moment of their being overwhelmed with the sand, which is so very fine as to resemble that used in England in hour-glasses. After three chapters of preliminary matter of intense interest, M. Bremon-tier, in his fourth chapter, gives an account of the manner in which he proceeded, not only to fix this sea of sand, but to render it productive of timber, resin, and other articles. This process is as remarkable for its simplicity as for its complete success. It consists in sowing on the surface seeds of the common broom, mixed with those of *Pinus Pinaster*; commencing on the side next the sea, or on that from which the wind generally prevails, and sowing in narrow zones, in a direction at right angles to that of the wind; the first-sown zone being protected by a line of hurdles, this zone protecting the second, the second the third, and so on, till the whole breadth of the downs in that locality is covered with plantation. From 4 lb. to 5 lb. of broom seed, and from 1 lb. to 2 lb. of pinaster seed, are sown per acre, and immediately covered with branches of pines, or of other trees, with the leaves on, brought from the nearest woods, in order to shelter and protect the seed, and, by the help of the hurdle fence, to retain the sand. These branches are laid down in a regular manner in the direction of the wind, and overlapping one another, so as to produce a sort of thatching to the surface; and, in places very much exposed, rods are laid across them, and firmly hooked down. In a word, wherever seeds are sown, the surface of the downs, as far as the sowing extends, may be said to be carefully thatched; branches of evergreen trees being used instead of straw. In six weeks or two months, the broom seeds have produced plants 6 in. in height, and which attain three or four times that height in the course of the first season. The pines do not rise above 3 in. or 4 in. the first year; and it is 7 or 8 years before they completely overtop the broom, which often attains, in these downs, from 12 ft. to 15 ft. in height. At the age of 10 or 12 years, the pines have, in a great measure, suffocated the broom, and they are then thinned, the branches cut off being used for the purpose of thatching downs not yet recovered, and the trunks and roots cut into pieces and burned, to make tar and charcoal. In about 20 years, the trees are from 20 ft. to 30 ft. in height; and they are now prepared for producing resin, which process is carried on, in the manner hereafter described, for 10 or 12 years; when the trees are cut down, and their branches applied, as before, for thatching, and their trunks and roots for making tar and charcoal; the self-sown seeds having furnished the surface with a progeny to succeed them. In 1811, a commission appointed by the French government made a report on the downs, and announced that about 12,500 acres of downs had been covered with thriving plantations, and that it was found a thatching or covering of any kind of vegetable herbage, such as straw, rushes, reeds, sea-weed, &c., might be used instead of branches, and was even preferable. Another improvement which had been tried, and found very successful, was the substitution of a fence of boards for that of wattled hurdles, as more completely excluding the wind. (See *Dict. des Eaux et Forêts*, tom. i. p. 816.) These plantations, and others in the Landes of Bordeaux, and be-

tween that city and Bayonne, which are there called *pignadas*, constitute the principal riches of the inhabitants, who are almost entirely supported by the preparation of resin and tar from the *pinaster* forests.

Properties and Uses. Though the wood of the *pinaster* is soft, and not of long duration, it is employed, in the marine arsenal at Toulon, for the outer cases of all the packages which are put on board vessels, and principally for the piles and props which are used for sustaining the frames of vessels while they are being constructed. In Bordeaux and in Provence, it is employed for the common kinds of carpentry, for packing-boxes, and for fuel; but the most valuable purposes to which the tree is applied in these countries is the production of resin, tar, and lampblack.

Mode of procuring the resinous Products of the Pinaster. These are obtained chiefly in the province of Guienne, from the trees which grow on the immense tract of sandy soil extending along the sea coast from Bayonne to Médoc in one direction, and from the sea to the borders of the river Garonne in the other. When the trees have attained the age of from 25 to 30 years, with trunks about 4 ft. in circumference, they are thought to have acquired sufficient strength to bear the extraction of their sap. The *résimier* (which is the name given to the person who collects the resin) usually tests the tree, by putting his arm round it, and if the trunk is so thick that he cannot see his fingers on the other side, he considers the tree of sufficient size for him to commence his operations. This he does by first stripping off a piece of the outer bark from a space of about 4 in. or 6 in. wide, and from 12 in. to 18 in. long. A hollow is then cut in the lower part of the trunk, with a hatchet slightly curved like a bill-hook, in such a manner as to retain the fluid resin to the extent of about half a pint; or a small trough is attached to the bottom of the channel formed by the removal of the bark. From this reservoir, in a direction upwards, and over the space from which the outer bark was removed, the wood is laid bare to the length of 6 in., and to the width of 4 in., and the resin oozes out from between the bark and the wood, and runs into the reservoir, from which it is taken with wooden or iron lades, or is conducted by the trough to a vessel proper to receive it. Every week, the person employed to perform the operation has occasion to reopen the wound, and slightly increase its height and breadth, without, however, ever exceeding 18 in. in length in the course of the season. These successive cuts are requisite, because the resinous matter flows more freely from new wounds than old ones; but, as the slightest touch is found sufficient, the operator should be careful not to injure the tree more than is necessary. This work requires activity, as one man is generally expected to be able to manage from 1500 to 2000 trees; and the operation is continued on the same tree by annually removing a portion of the bark, till the part laid bare is from 12 ft. to 15 ft. in height; which takes place, commonly, in 7 or 8 years. At that time, a fresh channel is commenced, so close to the preceding cut, as to leave only an inch or two of bark between them, and it is conducted gradually to the same height as the other. After this, other channels are successively cut, till the operator has completely encircled the tree; by which time, the first wounds are so well healed as to be ready to be cut again, if the operator has done his work properly. When the trees are to be thinned, those destined to be removed are cut into numerous channels all round the tree at once, and three times the height of those usually made, and this is continued for two or three years together; after which the trees are cut down and burned, to extract their tar. This operation is called *tailler à pin perdu*. When the wound is above the height of a man, the operator makes use of a pole cut with slanting notches to receive his feet; by the aid of which he climbs up the tree with great dexterity. When arrived at the necessary height, he twists his left leg round the pole and the tree, thus holding them firmly together, and then resting his right foot in one of the notches, he uses both his hands to cut the tree, as before

mentioned, with just as much ease as though he had a proper ladder leaning against the tree. The *résiniers* always climb with naked feet, and they are so expert, that it takes them only two or three minutes to mount a tree, enlarge the wound, and descend; the *résinier* then takes his pole on his shoulder and runs to the next tree, which he also mounts with such expedition, that a good workman will trim from 200 to 300 trees in a day. The season for cutting the pines is from May to September; and the resinous matter flows most freely in warm weather; it also flows much more freely from those trees which are exposed to the sun, than from those which grow in the shade. Besides the resin which flows from the wounds given to the tree, some drops exude from cracks in the bark, which dry, and form grains, often employed to adulterate the incense used in Catholic churches, by the persons who sell that substance. These natural drops are only produced when the tree is become very old, and when nearly all the resin which it can be made to yield by artificial means has been extracted from it. The resinous matter which exudes from the pinaster is called by several names in France, even in its raw state. That which incrusts on the sides of the wound is called *barras*. It is nearly as white as wax, and is used to mix with that substance for making tapers, to which it gives suppleness and elasticity. The *barras* is collected only once in the year, at the end of the season; and it is scraped off with a kind of iron rake. The principal substance which flows from the tree is called *galipot*, or *résine molle*. This substance, having been collected in the hollow cut in the tree, or in the trough attached to it, is put into large pits or reservoirs, capable of containing 150 or 200 barrels each, which pits are dug in the earth, and lined with planks made of the pine tree, fitted so close together as to prevent the liquid oozing through. It is afterwards melted in large copper caldrons, set in brickwork, to free it from the impurities mixed with it. It is necessary that the caldrons used for this purpose should be set in brickwork, with a proper chimney to convey away the smoke; as, should the smoke be suffered to come in contact with the resin, the whole would probably take fire. It is also necessary to keep continually stirring the resin, to prevent it from burning at the bottom of the caldron. When the resinous matter is to be made into brown resin, some of the *barras* is mixed with it; and, when the mixture is thought to be sufficiently boiled, a little of it is poured on a piece of wood; and if, when it becomes cold, it will crumble between the fingers, the resin is ready. It is then poured through a filter made of straw laid horizontally, and 4 in. or 5 in. thick, and run into barrels, where it is left to harden. In this state it is brown and brittle, and is called by the French *brés sec*, which is the brown resin of the shops.

To make yellow resin, when the resinous matter is boiling, a quantity of cold water is added, a few drops at a time: this makes the resin swell; and a trough having been previously fixed to one side of the caldron, the resinous matter flows through it to a vessel placed to receive it. From this the operator raises it by a ladleful at a time, and puts it back into the caldron; repeating the operation several times, till the resin becomes as yellow and as clear as wax. It is then filtered through straw into moulds hollowed in the sand, where it is formed into the cakes sold in the shops. To make these moulds, a circle is first traced in the sand, with a forked stick, which acts like a pair of compasses; the sand is then hollowed out with a knife, and the bottom and sides of the mould are well beaten with wooden mallets to make them perfectly hard and smooth. The cakes of resin generally weigh from 150 lb. to 200 lb. each. The straw through which the resinous matter was filtered, the pieces of wood through which it ran, and, in short, all the apparently waste materials used in preparing the resin, are carefully preserved, and burnt in a close furnace, in order to make lampblack; or in a tar furnace, to extract from them a resinous matter, which is sold cheap, and called in France *poir noir*, or black pitch.

Mode of preparing Lampblack. When the wood of the pine tree is burned

for tar, lampblack is formed on the cover of the furnace; but a superior kind is made from the straw, &c., used in straining the resin, which is burned for the sole purpose of obtaining this pigment. The apparatus employed for this purpose consists of a furnace, a chimney, and a small chamber, or box, for collecting the soot. The furnace is about 2 ft. 6 in. wide, 3 ft. or 4 ft. long, and 2 ft. 6 in. high; and it is usually set in brick. On each of the long sides, this furnace has an opening near the bottom, which can be shut at pleasure, by means of a little door attached to it. The furnace has a brick chimney, made almost horizontal, to conduct the smoke into the chamber, or box. The chimney is from 14 in. to 16 in. long, and 12 in. or 13 in. broad and high. At the place where the pipe of the chimney terminates, is constructed a chamber, or box, into which the pipe should enter some inches, so as to carry the smoke into its centre. This chamber is generally about 12 ft. square, and 9 ft. high in the roof; there is a door on one side, and in the upper part, or ceiling, there is an opening 5 ft. or 6 ft. square. The walls of the chamber are either lined with thin planks of wood, or plastered very smooth; and the door is fitted closely into a groove. Over the opening in the roof is placed a flannel bag, supported by rods of wood in the form of a pyramid, and composed of four pieces of coarse flannel sewed together. When the lampblack is to be made, a little of the straw through which the resin and tar have been strained, and some of the other refuse, are put into the furnace, and lighted, fresh straw impregnated with tar being strewed over the fire as fast as the other is consumed. The smoke passes into the chamber, and deposits its soot on the walls, and on the flannel bag, from both of which it is detached, after the whole of the straw and refuse has been burned, by striking the outside smartly with a stick. The flannel pyramid acts as a filter to the lighter part of the smoke, retaining the soot, and permitting the heated air to escape into the atmosphere. The door of the chamber is then opened, and the lampblack, being swept out, is packed in small barrels made of the wood of the spruce fir, for sale. In the Landes, the furnace and chimney are in the open air, and only the chamber is covered with a tiled roof; but in Germany the whole apparatus is constructed in a barn-like building, about 24 ft. long, by 12 ft. wide, and 10 ft. high. (See Hartig's *Lehrbuch für Forster*, as quoted by Baudrillart.) In Du Hamel's *Traite des Arbres et Arbustes*, art. Pin, he tells us that lampblack is sometimes made, in Paris and other cities, by burning the black resin in a kind of lamp, with a tin tube attached to serve as a chimney, the end of which tube is fixed in a close box, with an opening in the top, surmounted with a flannel cone, as before described.

Turpentine is rarely made from the pinaster, as it is very inferior to that produced by the silver fir. Oil of turpentine is, however, procured by distilling the galipot, or raw resin, obtained from the tree, with water. The oil ascends with the water, from which it is afterwards separated; and the residue is the colophony, or black resin, of the shops. The tar produced from the pinaster, which is very inferior to that of the Scotch pine, is called in France, *goudron des Landes*, or *goudron de Gaze*. When the trees have yielded all their resin, they are cut down, and the thickest parts of the trunk and roots cut into billets, about 2 ft. long and 2 in. square, which are piled up over an iron grating, and covered with clay at the sides, and burnt much in the same manner as has been already described (p. 2174.) for procuring tar from the *Pinus sylvestris*.

In Britain, it can hardly be considered advisable to plant the pinaster for its timber, in any situation where the Scotch pine or the larch will grow; and, even if it were profitable to employ the tree in the production of resin, our summers are probably not sufficiently warm to produce that secretion in any quantity. As an ornamental pine, the pinaster holds the first rank; and no plantation, where pines are admissible, ought to be without it.

Soil, Situation, Propagation, &c. A deep dry sand, or a sandy loam on a dry bottom, suits this tree best; and, according to Malesherbes and Rosier, and all the French authors who have written on it, it abhors chalk, and every de-

scription of calcareous soil. With respect to elevation, though it will endure the sea breeze, it will not grow, in England, much above the level of the sea. In Hampshire, at Muddiford, near Christchurch, which, in 1830, was one of the handsomest and best kept small places in England, there are some remarkably fine pinasters, growing so near the sea, that the salt water must have access to their roots. It is propagated by seeds, which may be procured in any quantity, and at a moderate price, from Bordeaux. Seeds are also ripened in several parts of England; and many trees, as we have already observed (p. 2219.), have been raised from them. The cones, which ripen in the August or September of the second year, may be gathered in October and November, and spread on a floor, under cover, to the thickness of 2 ft. or 3 ft.; and, during inclement weather in winter, women and children may be employed to take out the seeds. The first process consists in throwing the cones into boiling water for a few seconds, to soften the turpentine which glues the scales together; immediately afterwards, upon their beginning to snap or crackle, they should be taken out, otherwise the water gets to the seed and injures it. Every knob or scale is then separated with the point of a knife, and the seed is easily taken out. The time of sowing the seeds is April, and the covering from $\frac{1}{2}$ in. to $\frac{3}{4}$ in. When it is intended to plant this species on a large scale, the sooner the young plants are moved to where they are finally to remain, the better; but in nurseries, where there is only a demand for them in small quantities, they are best kept in pots.

Statistics. Pinus Pinaster in England. In the Environs of London. At Fulham Palace, 150 years old, it is 80 ft. high, the diameter of the trunk 4 ft., and of the head 30 ft.; the girth of this tree, in 1793, was 10 ft.; and in 1837, 12 ft. (See p. 43) At York House, Twickenham, it is 42 ft. high, the diameter of the trunk 2 ft. 6 in., and of the head 33 ft. At Abercorn Priory, Stanmore, it is 60 ft. high; and at Syon are several 60 ft. high.—South of London. In Cornhill, at Carlew, it is 82 ft. high, diameter of the trunk 3 ft. 6 in., and of the head 50 ft. In Hampshire, at Testwood, 70 years planted, it is 53 ft. high. In Surrey, at Oakham, 33 years planted, it is 45 ft. high; at Barwood Park, it is 50 ft. high, the diameter of the trunk 4 ft. 6 in., and of the head 60 ft.; at Deepdene, 9 years planted, it is 10 ft. high.—North of London. In Berkshire, at Bear Wood, 14 years planted, it is 26 ft. high; at White Knights, 35 years planted, it is 45 ft. high. In Durham, at Southend, 40 years planted, it is 60 ft. high, with a trunk 3 ft. in diameter. In Leicestershire, at Elvaston Castle, 33 years planted, it is 40 ft. high. In Nottinghamshire, at Clumber Park, it is 60 ft. high, the diameter of the trunk 3 ft. 6 in., and of the head 50 ft. In Pembrokeshire, at Stackpole Court, 35 years planted, it is 40 ft. high. In Radnorshire, at Maceslaugh Castle, it is 48 ft. high, with a trunk 1 ft. 10 in. in diameter. In Staffordshire, at Teddesley Park, 8 years planted, it is 16 ft. high; in the Handsworth Nursery, 6 years planted, it is 12 ft. high. In Suffolk, at Finborough Hall, 15 years planted, it is 25 ft. high; at Ampton Hall, 12 years planted, it is 22 ft. high. In Worcestershire, at Hagley, is one with a trunk 4 ft. in diameter; at Croome, 70 years planted, it is 90 ft. high, the diameter of the trunk 2 ft. 4 in., and of the head 30 ft.

Pinus Pinaster in Scotland. South of Edinburgh. In Berwickshire, at the Hired, 90 years planted, it is 25 ft. high. In Haddingtonshire, at Tynninghame, it is 46 ft. high, the diameter of the trunk 2 ft., and of the head 32 ft.—North of Edinburgh. In the Isle of Bute, at Mount Stewart, 10 years planted, it is 17 ft. high. In Ross-shire, at Brahan Castle, it is 35 ft. high, the diameter of the trunk 1 ft. 6 in., and of the head 36 ft.

Pinus Pinaster in Ireland. At Dublin, in the Glasnevin Botanic Garden, 35 years planted, it is 15 ft. high. In Kilkenny, at Woodstock, 80 years planted, it is 72 ft. high, the diameter of the trunk 2 ft. 9 in., and of the head 18 ft. In Down, at Mount Stewart, 50 years planted, it is 46 ft. high. In Galway, at Coole, it is 46 ft. high.

Pinus Pinaster in Foreign Countries. In France, in the park of Clervaux, 44 years planted, it is 82 ft. high, the diameter of the trunk 2 ft. 6 in., and of the head 52 ft. In Bavaria, in the Botanic Garden, Munich, 18 years planted, it is 15 ft. high. In Austria, at Vienna, in Rosenthal's Nursery, 25 years planted, it is 30 ft. high. At Brück on the Leytha, 40 years planted, it is 80 ft. high. In Italy, at Monza, 24 years planted, it is 45 ft. high.

Commercial Statistics. Seeds, in London, are 3s. per lb; one year's seedling plants are 10s. per thousand, and one year transplanted 25s. per thousand; and plants in pots are 1s. 6d. each. At Bollwyller, plants are 1 franc each; and at New York, 1 dollar.

‡ 13. *P. PI'NEA L.* The Stone Pine.

Identification. Lin. Sp. Pl., 1419; Mill. Dict., No. 2; Hunt. Evel. Syl., p. 266; Vill. Dauph., 3, p. 806; Lamb. Pin., ed. 2, 1. t. 10, 11.; N. Du Ham., 5, p. 2421; Alt. Hort. Kew., ed. 1, 3, p. 363; Willd. Berol. Baum., p. 209; Michx. N. Amer. Syl., 3, p. 116; Hayne Dend., p. 241; Lawson's Manual, p. 241; Bon Jard., 1837, p. 974; Lodd. Cat., ed. 1836.

Synonymes. *P. sativa* Bauh. Pin., p. 491.; *Blackw.*, t. 189.; *Du Ham. Arb.*, 2, p. 125.; *P. domestica* Math. Comm., 87.; *Tabern. Ic.*, 936.; Pin Pignon, Pin bon, Pin cultivé, Pin Pmter, Fr.; Gemeinliche Fichte, Ger.

Engrossings. Blackw., t. 189.; Du Ham. Arb., 2, t. 97.; Tabern. Ic., 936.; Lamb. Pin., 1, t. 10, 11.; N. Du Ham., 5, t. 72, f. 3.; Folt. et Turp., t. 125.; Michx. N. Amer. Syl., 3, t. 135.; our *Ag.* 2109.; to our usual scale; *Ag.* 2106. to 2108., of the natural size, from Dropsmore and White Knights; and the plate of this tree in our last Volume.

Spec. Char., &c. Leaves in pairs. Cones ovate, obtuse, nearly as long as the leaves, their scales with recurved deciduous points. Seed bony, with very short wings. Crest of the anthers jagged. (*Smith*) The buds (see *fig.* 2106.) resemble those of *Pinaster*, but are smaller in all their dimensions, much less pointed, more woolly, and wholly without resin. The surrounding buds are nearly as large as the central one. The leaves are from 5 in. to 7 in., and sometimes 8 in., long, serrated; sheaths, at first, $\frac{1}{2}$ in. long, afterwards becoming lacerated, shortened to half their length, and ringed with four or five rings. Cone from 5 in. to 6 in. in length; and from $3\frac{1}{2}$ in. to 4 in. in breadth; scales large and woody, from 2 in. to $2\frac{1}{2}$ in. in length, and from 1 in. to $1\frac{1}{2}$ in. in breadth, with the thickened part pyramidal, rhomboidal, and sometimes hexagonal in the plan, resembling those of *P. Pinaster*, but having four ribs from the four angles, instead of two from the lateral angles. The ribs meet in a small rhomboidal pyramid, of a grey colour, which terminates in a broad blunt prickle. The colour of the entire cone is much lighter than that of *P. Pinaster*, and is of a pale wainscot colour. Seeds, without the wing, $\frac{2}{3}$ in. long, and from $\frac{1}{4}$ in. to $\frac{3}{8}$ in. broad; with the wing, 1 in. long. Cotyledons 9 to 11. The tree flowers, in the climate of London, in the latter end of May or the beginning of June.



2106

Varieties.

- ‡ ? *P. P. 2 fragilis* N. Du Ham., v. p. 242., is the only variety mentioned by Continental authors; and it only differs from the species in having a tender shell to the seed. It is cultivated in the kingdom of Naples on this account, and because the kernel, like that of the species, is white, mild, sweet, and agreeable to the taste. It is a remarkable fact, that, though this variety has been known since the days of Pliny, and though its excellence is universally acknowledged, it has never been introduced into France. If the *P. Pinea* were to be cultivated in the warmer parts of England, as a fruit tree, this variety would deserve to be preferred.
- ‡ *P. P. 3 crética* Hort. — There is a plant of this variety in the Horticultural Society's Garden, which, after being seven years planted, is 5 ft. high. The leaves seem to be rather finer than those of the species.
- ‡ *P. P. 4 americana* Hort. — The plant in the Horticultural Society's Garden bearing this name is 4 ft. high, and appears not to differ from the species. The name of *americana*, sent with the plant by F. Bourne, Esq., would imply that the seed was received from America, where, however, the stone pine is known not to be indigenous.

Description. In the south of Europe, this species is a lofty tree, with a spreading head forming a kind of parasol (see *fig.* 2108.), and a trunk 50 ft. or 60 ft. high, clear of branches. The bark of the trunk is reddish, and sometimes cracked; but the general surface of the bark is smooth, except on the smaller branches, where it long retains the marks of the fallen leaves, in the shape of bristly scales. The leaves are of a deep green, but not quite so dark as those of the *pinaster*; they are semicylindrical, 6 in. or 7 in. long, and $\frac{1}{4}$ in. broad, two in a sheath, and disposed in such a manner as to form a triple spiral round the branches. The catkins of the male flowers are yellowish; and, being placed on slender shoots of the current year, near the extremity, 20 or 30 together, they form bunches, surmounted by some scarcely developed leaves. Each catkin is not more than $\frac{1}{2}$ in. long, on a very short peduncle, and with a rounded denticulated crest. The female catkins are whitish, and are situated two or three together, at the extremity of the strongest and most vigorous shoots. Each female catkin has a separate

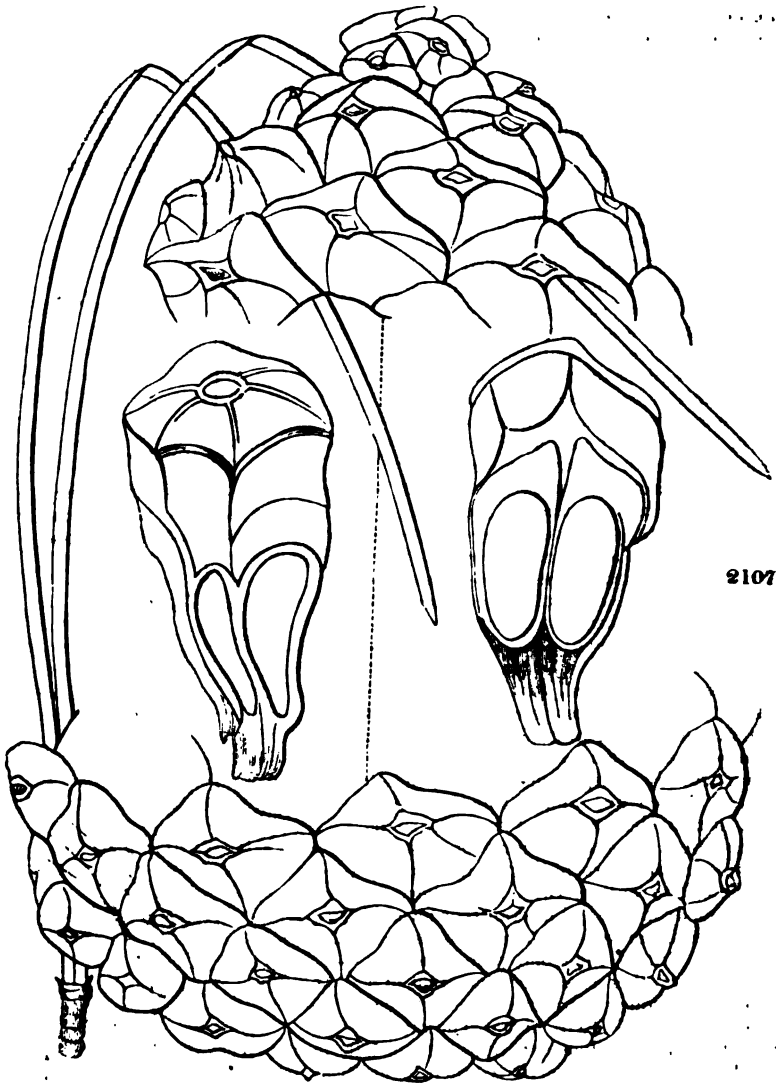

peduncle, charged with reddish, scarios, lanceolate scales, and is surrounded at its base with a double row of the same scales, which served to envelope it before it expanded; its form is perfectly oval, and its total length about $\frac{1}{2}$ in. The scales, or calyxes, which form the female catkin are of a whitish green; the bractes on the back is slightly reddish on its upper side; and the stigma, which has two points, is of a bright red. After fecundation, the calyxes augment in thickness; and, becoming firmly pressed against each other, they form by their aggregation a fruit, which is three years before it ripens. During the first year, it is scarcely larger than the female catkin; and during the second year it becomes globular, and about the size of a walnut. The third year,

the cones increase rapidly in size; the scales lose their reddish tinge, and become of a beautiful green, the point alone remaining red; and at last, about the end of the third year, they attain maturity. At this period, the cones are about 4 in. long, and 3 in. in diameter, and they have assumed a general reddish hue. The convex part of the scales forms a depressed pyramid, with rounded angles, the summit of which is umbilical. Each scale is hollow at its base; and in its interior are two cavities, each containing a seed much larger than that of any other kind of European pine, but the wing of which is, on the contrary, much shorter. The ligneous shell which envelopes the

kernel is hard and difficult to break in the common kind, but in the variety *P. P. 2 fragilis* it is tender, and easily broken by the fingers. In both, the kernel is white, sweet, and agreeable to the taste. The taproot of the stone pine is nearly as strong as that of *P. Pinaster*; and, like that species, the trees, when transplanted, generally lean to one side, from the head not being correctly balanced. Hence, in full-grown trees of the stone pine, there is often a similar curvature at the base of the trunk, to that of the *pinaster*, which has been already mentioned and accounted for, p. 2218. The palmate form of the cotyledons of the genus *Pinus* is particularly conspicuous in those of *P. Pinæa*. When one of the ripe kernels is split in two, the cotyledons separate, so as to represent roughly the form of a hand; and this, in some parts of France, the country people call *la main de Dieu*, and believe to be a remedy in cases of intermittent fever, if swallowed in uneven numbers, such as 3, 5, or 7. In Britain, the stone pine is seldom seen in any other character than that of a large bush, though there are specimens between 30 ft. and 40 ft. high. The rate of growth is slow, seldom exceeding 6 ft. or 8 ft. in ten years. The plant in the Horticultural Society's Garden, figured in our last Volume, attained the height of 11 ft. in 10 years; and one at Dropmore, 23 ft. in 22 years. The duration of the tree is much greater than that of the *pinaster*, and the timber is whiter and somewhat more durable. In the climate of London, trees of from 15 to 20 years' growth produce cones.

Geography. The stone pine is a native of Italy, Spain, Greece, the coast of Barbary, and probably some parts of Asia. Dr. Sibthorp found it abundant in the sandy plains of Elis, whence the nuts are exported for eating, and where the timber is often used for ship-building. It is also found wild in the south of France; but it appears to be rather a doubtful native there, as it never forms forests, and very rarely woods of any considerable extent; and the trees are not only either isolated or thinly scattered, but are also generally



found in the neighbourhood of habitations. It grows with the greatest luxuriance on the deep sandy banks of rivers, or the shores of the sea; and some remarkably fine specimens of it were observed by M. Desfontaines on the shores of the Mediterranean, between Marscilles and St. Tropez; and by M. Audibert, near Saintes, and in the neighbourhood of Hières. The only instance recorded of a wood of the stone pine being found in France is that mentioned by M. Malesherbes, in Lower Languedoc, on the right bank of the Rhone. (*Desf. Hist. des Arbres*, ii. p. 622.) In Italy, the stone pines of Ravenna are celebrated for their beauty; and, indeed, the stone pine forms the most ornamental tree in the landscape scenery of Italy; as well as occasionally in Britain, where its fine dark leaves, copious male blossoms, which diffuse a shower of sulphureous pollen on all the neighbouring plants, and its mossy cones, render it as striking as it is beautiful. Miller thinks the tree not a native of Europe, because it is never found growing but near dwelling-houses. It is certainly plentiful in China, he says, whence he had several times received the seeds. (*Dict.*, ed. 6., 1752.)

History. Pliny praises the stone pine for bearing fruit in three stages of its growth at the same time. He also speaks of the kernels, which, he says, were preserved in honey; and he mentions the variety with tender shells, as being then common in the vicinity of Tarentum. The kernels have been found among the domestic stores, in the pantries of Herculaneum and Pompeii. The stone pine is mentioned by nearly all the writers of travels in the south of Europe, from the beautiful effect it produces in the scenery; but the most remarkable tree recorded of this species is one in the south of France, on the Sablettes, a tongue of land which joins the peninsula of Giens to Provence. This pine is conspicuous for its great beauty and majestic shape. According to M. G. Robert, who measured it on the spot, it has a trunk 12 ft. in circumference, which is clear of branches to the height of 30 ft.; at which point the branches that form the head commence, and extend in height 30 ft. more, and horizontally so as to cover a circle of 100 ft. in diameter. This tree is placed in a most conspicuous and striking situation, it being the only tree existing in the middle of the tongue of land on which it grows, and being close to the Mediterranean. There is, indeed, little doubt but that its roots find their way into that sea, as, when a trench was opened in the immediate vicinity of the tree, it filled instantly with salt water. It is worthy of notice in the history of the stone pine of Sablettes, that, about the year 1770, during the American war, an English and an American ship being engaged in battle in the Mediterranean, an English bullet struck the trunk of this pine, and lodged in it, where it has remained ever since, without, apparently, doing the tree the slightest injury, the wound having closed over, and even the scar having disappeared.

The stone pine was introduced into England before 1548, as it is mentioned in Turner's *Names of Herbes, &c.*, published in that year; and, as the seeds are easily procured from Italy, it has been frequently planted in collections. Owing to its slow growth and comparative tenderness, it has, however, been generally choked by other trees, so that good specimens are rarely to be met with in English plantations.

Poetical Allusions. The following description of the stone pines of Ravenna is by Leigh Hunt:—

“ Various the trees and passing foliage there,
Wild pear and oak, and dusky juniper,
With briony between in trails of white,
And ivy, and the suckle's streaky light,
And moss, warm gleaming with a sudden mark,
Like flings of sunshine left upon the bark,
And still the pine, long-haired, and dark, and tall,
In lordly right, predominant o'er all.
Much they admire that old religious tree,
With shaft above the rest up-shooting free,
And shaking, when its dark locks feel the wind,
Its wealthy fruit with rough mosaic rind.”

Properties and Uses. The wood of the stone pine is whitish, moderately

resinous, and very light. It is used, in Italy and the south of France, in carpentry and joinery, and for gutters, pumps, and covering the sides of ships; and Olivier informs us that the Turks use it for masts. The kernel of the fruit has a taste which approaches to that of the hazel nut, and, in France and Italy, is much esteemed for the dessert. Sir George Staunton mentions that the kernels of the stone pine are also much relished by the Chinese. In Italy, they are put into several kinds of *ragoûts*, and they prove excellent in sugarplums, instead of almonds. In Provence, they are extensively consumed along with Corinth raisins, the dried currants of the shops. The kernels require to be kept in the cone till they are about to be used, because they become speedily rancid when taken out and exposed to the air. In the cone, they will preserve their vitality, their freshness, and their taste, five or six years. They may also be preserved in salt; but in this case they lose great part of their flavour. In Pliny's time they were preserved in honey. They were formerly much used in medicine, but this is no longer the case. They are very eagerly sought after by squirrels, rats, and dormice. The squirrels which live in pine forests are chiefly nourished by these kernels; and they contribute towards the dissemination of the seeds, by striking the cones against the rocks to make the scales open. The crossbill (*Lóxia curvirostra*) is the principal bird that lives on the kernels of the stone pine. To get out the kernel, the bird places the under part of its bill under the scale, in order to raise it up, and then separates it with the upper part of its bill. The crossbill is a solitary gloomy bird, which is chiefly found in pine forests, where it makes its nest in the middle of January, in the branches of the largest pines, fixing it there with the resin of the trees, and coating it externally with the same material, in such a manner as to prevent it from being penetrated by either rain or snow. The kernels of the stone pine are occasionally brought to the dessert in England; for which purpose the cones are regularly imported by the fruiterers.

As a tree, the stone pine may be considered very ornamental where it grows freely, or where it has grown up with an erect trunk, and attained considerable age. Gilpin speaks highly in its favour; but we cannot help thinking that he must either allude chiefly to what he has seen in prints or pictures, or to the pinaster, because we have never seen or heard of any stone pine in England of a sufficient size to justify his description: at all events, it is obvious that his ideas were not clear as to these trees; because he speaks of the pinaster, the cluster pine, and the stone pine, as three distinct kinds. From specimens and dimensions that have been sent to us from different parts of the country, we find that the pinaster is very frequently supposed to be the stone pine. Indeed, it may be considered as the stone pine of Britain; and, as Gilpin's observations are almost as applicable to it as to the stone pine, and are, besides, beautiful in themselves, we shall give them at length:—

“After the cedar, the stone pine deserves our notice. It is not indigenous to our soil, but, like the cedar, it is in some degree naturalised; though in England it is rarely more than a puny half-formed resemblance of the Italian pine. The soft clime of Italy alone gives birth to the true picturesque pine. There it always suggests ideas of broken porticos, Ionic pillars, triumphal arches, fragments of old temples, and a variety of classic ruins, which in Italian landscape it commonly adorns. The stone pine promises little, in its infancy, in point of picturesque beauty: it does not, like most of the fir species, give an early indication of its future form. In its youth, it is dwarfish and round-headed, with a short stem, and has rather the shape of a full-grown bush than of an increasing tree. As it grows older, it does not soon deposit its formal shape. It is long a bush, though somewhat more irregular, and with a longer stem; but, as it attains maturity, its picturesque form increases fast. Its lengthening stem assumes, commonly, an easy sweep. It seldom, indeed, deviates much from a straight line; but that gentle deviation is very graceful, and, above all other lines, difficult to imitate. If acci-

dentally either the stem or any of the larger branches take a larger sweep than usual, that sweep seldom fails to be graceful. It is also among the beauties of the stone pine, that, as the lateral branches decay, they leave generally stumps, which, standing out in various parts of the stem, break the continuity of its lines. The bark is smoother than that of any other tree of the pine kind, except the Weymouth; though we do not esteem this among its picturesque beauties. Its hue, however, which is warm and reddish, has a good effect; and it obtains a kind of roughness by peeling off in patches. The foliage of the stone pine is as beautiful as the stem. Its colour is a deep warm green; and its form, instead of breaking into acute angles, like many of the pine race, is moulded into a flowing line by an assemblage of small masses. As age comes on, its round clumpish head becomes more flat, spreading itself into a canopy, which is a form equally becoming; and yet I doubt whether any resinous tree ever attains that picturesque beauty in age which we admire so much in the oak. The oak continues long vigorous in his branches, though his trunk decays; but the resinous tree, I believe, decays more equally through all its parts, and, in age, oftener presents the idea of vegetable decrepitude than that of the stout remains of a vigorous constitution; and yet, in many circumstances, even in this state, it may be an object of picturesque notice. Thus, we see in the form of the stone pine what beauty may result from a tree with a round head, and without lateral branches, which requires, indeed, a good example to prove. When we look on an ash or an elm, from which the lateral branches have been stripped, as is the practice in some countries, we are apt to think that no tree with a head placed on a long stem can be beautiful; yet in Nature's hands, which can mould so many forms of beauty, it may easily be effected. Nature herself, however, does not follow the rules of picturesque beauty in the production of this kind of object. The best specimen of the stone pine I ever saw grew in the Botanical Garden at Oxford; but, for the sake of the ground it occupied (I never heard any other reason suggested), it was lately (1791) cut down." (*Gilp. For. Scen.*, i. p. 83.) Sir Thomas Dick Lauder adds to this passage, that he quite agrees with Gilpin as to the picturesque beauty of the stone pine. "We frequently find it introduced into the landscapes of Claude;" he continues, "the artist availing himself of its heavy deep-toned mass of foliage to give effect to the brilliancy of his sky and distance. It is quite associated in our minds with Italy, and her magnificent remains." (*Laud. Gilp.*, i. p. 169.)

Soil, Situation, Propagation, and Culture. The soil should be deep, sandy, and dry, and the situation sheltered, though the plants should not be crowded. The seeds are procured from foreign cones, which are generally purchased in the autumn, or at the beginning of winter, and the seeds taken out of them by throwing them into hot water, and treating them like those of pinaster. They are frequently sown in pots in the course of the winter, and preserved in a frame, and kept gently moist, till the spring; when most of the seeds will come up, though some will remain in the ground till the second year. Their tardy germination is owing to the thickness of the shell of the seed, which some cultivators break before sowing, though at the risk of injuring the seed. The plants which come up should be transplanted into small pots, after midsummer of the same year, or, at all events, not later than the following spring; and, for two or three years, they should be kept during winter in a frame, quite close to the glass. The plants are very tender for the first two or three years; but in the fourth and fifth years they will endure the open air, in the climates of London and Paris, without any protection. The leaves of this species, as well as of several others, have quite a different appearance for the first two years from what they have ever afterwards: they are very glaucous, ciliated on their margins, very short, and very sharp-pointed. During this period, they are single and without sheaths; but afterwards they come out in pairs, with sheaths, these pairs being what are considered by botanists as abortive shoots, as already mentioned, p. 2108. The nursery treatment of

the stone-pine is the same as that recommended for the pinaster; this species having also very long taproots, which render it necessary to be extremely careful in taking them up for removal: indeed, they should generally be grown in pots; and, when they are turned out of the pots to be planted where they are finally to remain, the greatest care should be taken to stretch out the roots, and to spread them carefully in every direction.

Statistics. It is remarkable that there is no record of a stone-pine in England which has attained a timber-like size. No specimens are mentioned either by Miller or Dr. Walker; and the one stated by Gilpin to have been growing in the Botanic Garden at Oxford, and another, with a straight stem, free from knots for a considerable height, with a great branching head, at Old Court, in Ireland, described by Hayen, were probably pinasters. There is no tree of this species at Whitton or Foss's Hill; the one at Kew is a mere bush; as is that at Fuser's Cross; and Mr. Lambert only mentions one in the garden of H. Cavendish, Esq., at Clapham, but does not state its age or height.

Existing Trees. In England, at Lacombe, 11 years planted, 16 ft. high. In Berkshire, in a garden on the right hand of the road on entering Reading, a handsome tree, 30 ft. high, with a clear trunk of 15 ft., and a broad spreading head upwards of 30 ft. in diameter. In Surrey, at Becht Park, 16 years planted, 18 ft. high; at Oakham, 33 years planted, 23 ft. high; at Burwood Park, 35 ft. high. In Durham, at Southend, 19 years planted, it is 8 ft. high. In Hertfordshire, at Chestnut, 8 years planted, 6 ft. 6 in. high. In Staffordshire, at Trentham, 26 years planted, it is 16 ft. high; in the Handsworth Nursery, 19 years planted, it is 8 ft. high. In Suffolk, in the Bury Botanic Garden, 8 years planted, it is 8 ft. high; at Finborough Hall, 16 years planted, 18 ft. high; at Ampton Hall, 14 years planted, 9 ft. high.—In Scotland, in Kirkeudbright, at St. Mary's Isle, 14 years planted it is 8 ft. high.—In Ireland, at Dublin, in the Glasnevin Garden, 33 years planted, 30 ft. high. In Cook, at Castle Freke, 38 ft. high. In Down, at Ballyeady, 60 years planted, 45 ft. high.—In France, at Paris, in the Jardin des Plantes, 100 years old, it is 50 ft. high, diameter of the trunk 2 ft., and of the head 42 ft.; at Toulon, in the Botanic Garden, 10 years planted, 12 ft. high; at Avanches, 99 years planted, 30 ft. high.—In the greater part of Germany, it is a green-house plant.

Commercial Statistics. Seeds, in London, are 2s. per lb. Plants, one year's seedlings, 5s. per hundred; in pots, from 1 ft. to 2 ft. high, 1s. and 1s. 6d. each; at New York, one dollar.

§ iv. *Halepenses.*

Sect. Char. Leaves slender. Cones as long as the leaves, stalked, with the terminations of the scales flattened. Buds small, roundish, imbricated, and altogether without resin.

‡ 14. *P. HALEPENSIS* Ait. The Aleppo Pine.

Identification. Ait. Hort. Kew., 3. p. 367; Lam. Pin., ed. 2., 1. t. 7.; Desf. Fl. Alt., 2. p. 322; Mill. Dict., No. 8. t. 208.; N. Du Ham., 5. p. 238.; Hayen's Dend., p. 173.; Lawson's Manual, p. 344.; Lond. Cat., ed. 1836.

Spoken. *P. hierosolymitana* Du Ham. Arb., 2. p. 126.; *P. maritima prima* Mathias; Pin. de Jérusalem, p.

Engravings. Mill. Dict., No. 8. t. 208.; Lam. Pin., ed. 2., 1. t. 7. (exclusive of the ripe cones, which is that of *P. Laricio*); our fig. 2113., to our usual scale; and figs. 2110. to 2112.; all from specimens from a tree in the Horticultural Society's Garden.

Spec. Char., &c. Leaves in pairs, very slender. Cones pyramidal, rounded at the base, turned downwards, smooth, solitary or in pairs, stalked. (*Lois.*, and obs.) Buds (see fig. 2110.) from $\frac{1}{4}$ in. to $\frac{1}{2}$ in. long; and from $\frac{1}{4}$ in. to $\frac{1}{2}$ in. broad; imbricated, roundish, somewhat pointed, wholly without resin; and altogether like those of a pinaster in miniature. Cones (fig. 2111.) from $2\frac{1}{2}$ in. to 3 in. in length; and from $1\frac{1}{2}$ in. to $1\frac{3}{4}$ in. in breadth; invariably turned downwards, so as to form an acute angle with the stem. Footstalks of the cones from $\frac{1}{2}$ in. to $\frac{3}{4}$ in. in length. Scale (fig. 2112. a) from $1\frac{1}{4}$ in. to $1\frac{1}{2}$ in. long, and $\frac{3}{4}$ in. broad. Seed, without the wing (c), from $\frac{1}{2}$ in. to $\frac{3}{4}$ in. in length, and $\frac{3}{4}$ in. in breadth; with the wing (b), from 1 in. to $1\frac{1}{2}$ in. in length. Cotyledons about 7. The tree flowers, in the climate of London, about the end of May or the beginning of June. 2110

Varieties. None of these are very distinct. *P. brütia*, judging from the young plant in the Horticultural Society's Garden, would appear to belong to *P. halepensis*, from the leaves and buds; but, as the cones in Mr. Lambert's figure are sessile, produced in clusters, and stand out horizontally, it seems rather to approach *P. Pinaster*; and we shall therefore give it as a doubtful species in a future page. Two trees of *P. halepensis* in the Horticultural Society's Garden have borne cones; and those of one tree are considerably smaller than those of the other; and this is the only variety of the existence of which we are certain from

ocular demonstration. One has been introduced from the neighbourhood of Genoa by Captain Cook, of which there is a young plant in the Horticultural Society's Garden; but it has not yet shown any character differing from that of the species; a cone, however, which we possess of this variety is smaller than that of the species; and the raised ends of the scales are more prominent, approaching in a slight degree to the form of those of the cones of *P. Pináster*. Mr. Lambert, in the second edition of his *Genus Pinus*, has figured what appears to be a variety of *P. halepensis* under the name of *P. marítima*; but, as he has given in his figure three cones, of three different shapes, and as no living plant in England is referred to, nothing can be determined definitely respecting it. We shall, however, give the name among those of other varieties, real or conjectural.

‡ *P. h. 2 minor* has the cones rather smaller than the species. There is a tree in the Horticultural Society's Garden, which, in 1837, after having been 15 years planted, was 20 ft. high, with a spreading branchy habit; but without any other marked difference from the species.

‡ *P. h. 3 marítima*, *P. marítima* Lamb. *Pin.*, ed. 2., t. 6. — According to Mr. Lambert's figure, the cones of this variety, in the different forms in which he has given it, are all larger than those of the species. The three cones given in Mr. Lambert's plate are, one from the Sherardian herbarium, which points downwards, and only differs from the species in being thicker; one collected in Greece by the Hon. W. F. Strangways, which points upwards; and one from a tree in Syon Gardens, which no longer exists, but which is stated in the text also to point upwards. A tree in the Horticultural Society's Garden, received from Sir Charles Monck, and said to be the true *P. marítima* of Lambert, is nothing more than *P. Pináster*; as is the one at Dropmore, received from Mr. Lambert himself. It is somewhat more fastigiate in habit than that tree is generally, but this appears to us nothing more than a variation. Mr. Lambert has given the following particulars respecting the uses made of this variety in Greece, from Dr. Sibthorp's papers, published in Walpole's *Memoirs*: — "*Peukos*, one of the most useful trees in Greece. It furnishes a resin (*hretine*), tar, and pitch (*pissa*); all of considerable importance for economical purposes. Throughout Attica, the wine is preserved from becoming acid by means of the resin, which is employed in the proportion of an oke and half to 20 okes of wine. The tar and pitch for ship-building are taken

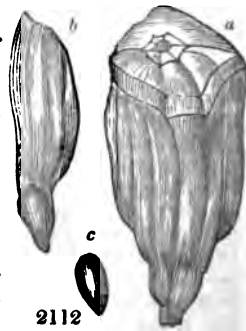

from this tree, and from the *Pitus* (*Pinus Pinea*). The resinous parts of the wood of the *Peukos* are cut into small pieces, and serve for candles, called *dadia*. The cones (*koinoi*) are sometimes put into the wine barrels. The bark is used in tanning hides. The wood is much employed by carpenters in building." (*Lamb. Pin.*, ed. 2., 1. p. 17.)

- ‡ *P. h. 4 genuensis*, *P. genuensis* Cook. — The plant in the Horticultural Society's Garden was raised from cones brought from the coast of Genoa, by Captain Cook, in 1830. It has not yet borne cones in England, and does not appear, in foliage and habit, different from the species. The cone we possess is 3 in. long, and $1\frac{1}{2}$ in. in diameter at the broadest end, and regularly pyramidal. The length of the stalk is $\frac{3}{8}$ in.

Description. A tree, rising generally to the height of 25 ft. or 30 ft., though sometimes to that of 40 ft. or 50 ft., with a trunk acquiring, at the ground, from 4 ft. to 5 ft. of circumference. When young, it has a spreading head, with more slender branches than most other pines. The bark of the trunk and branches is greyish or ash-coloured, and rather smooth, even when the tree is old. The bark of the young branches is greenish, and less scaly than is usual in species of this genus. The old trees have a round head, and are generally, in England at least, broader than they are high. The leaves are of a deep green, 2 in. or 3 in. long, most commonly 2 in a sheath, but sometimes, though rarely, 3; and they are so disposed as to form a double spiral round the branches. They never remain longer than two years on the tree; in consequence of which the branches of old trees have a naked appearance, and the head looks open, straggling, and thin. The male catkins are reddish, from $\frac{1}{2}$ in. to $\frac{3}{8}$ in. in length, on short pedicels, disposed in branches of 30 or 40 together. The crest is large, proportionably to the size of the anthers, and is rounded. The female catkins are not, as is usual, placed at the extremity of the shoot of the year, but come out at the side



of the shoot, and towards the middle of it: they point outwards during their flowering, and are of a greenish hue, slightly tinged with red. The cones have very strong peduncles of half an inch or more in length; and, as they advance in size, they take a direction almost perpendicularly downwards. The cones are of a very regular pyramidal form, somewhat rounded at the base; 2 in. or 3 in. long; of a yellowish or fawn colour, but taking a greyish tinge when mature. The extremities of the scales project very slightly: they are scarcely angular, and are somewhat convex. The seeds are oval $1\frac{1}{4}$ in. long, pointed at their lower extremities, and with the wings measuring 1 in. in length. The tree grows rapidly when young, acquiring the height of 15 ft. or 20 ft. in ten years; after which it increases more slowly, and, in England at least, loses much of its beauty, by the head becoming open and straggling. The head, from its rapid growth, generally leans to the side opposite to that from which the prevailing wind of the locality blows the branches, in young trees, generally resting on the ground; so that the trunk is seldom, if ever, erect and straight. The cones are produced at the age of 10 years, but seldom in any great quantity. The finest trees which we have seen of this species are at White Knights and Dropmore; at which places, in 1837, there were trees 17 ft. and 27 ft. high. That in the Horticultural Society's Garden, of which a portrait is given in our last Volume, was, in

1834, after being 12 years planted, 18 ft. high. *P. halepensis* is the most tender of European pines, not even excepting *P. Pinæ*.

Geography. The Aleppo pine is indigenous in Syria, in the neighbourhood of Aleppo, in Jerusalem; in Barbary, on the mountains of Atlas; on the hills of Provence, and in the neighbourhood of Toulon and Frejus, in France, where it is called the pin blanc; and throughout great part of Spain. According to Captain Cook, it forms great part of the forests of Upper Catalonia, and in the Aleborca, a district of New Castile, near the Guadaluakara, but not rising so high on the mountains as the *P. Pinaster*. It is always found in dry, sandy, warm soils, and thrives admirably among rocks, where the roots of few other trees will find subsistence.

History. The Aleppo pine was first cultivated in England in 1683, by Bishop Compton, under the name of *P. hierosolymitana*. (*Ray's Letters*, p. 171.) In 1732, cones of the tree were sent from Aleppo to Miller, who raised plants from them, most of which, however, were destroyed by the severe winter of 1740. As cones are readily procured from France, the species is not rare in British nurseries; but, though one of the most ornamental of the genus, it has not been much planted. In Scotland and Ireland, it is rarely to be met with; it is not common in the neighbourhood of Paris, being destroyed there by very severe winters, such as that of 1788, which killed all the trees in the vicinity of the French capital; and in Germany, and at New York, it is a green-house plant.

Properties and Uses. The wood is white, with a fine grain, which becomes dark in old trees. In Provence, it is much used for joinery, and also for making pumps for vessels. According to Bosc (*Ann. de l'Agr.*, Feb. 1826, as quoted by Delamarre), the Aleppo pine is very common between Marseilles and Antibes, where it rivals in height and thickness the pinaster, and its wood is considered very superior. The chief employment, however, of the tree is for extracting its resinous products, for which it is much preferred to the pinaster. The liquid resin extracted from this tree in Provence, where it is called *le pin blanc*, is often sold for Venice turpentine; and the tar produced by it in the same country is esteemed greatly superior to that of Bordeaux, which is made from the pinaster. The variety *P. h. maritima*, as we have seen, p. 2232., is used for various purposes in Greece, and, among others, the bark is employed for tanning hides. In Britain, *P. halepensis* can only be considered as ornamental; and, when planted singly on a lawn, it forms one of the handsomest species of the genus. According to Bosc, it is the most elegant of European pines.

Statistics. In England. At Fulham Palace, 17 years planted, it is 20 ft. high. In Surrey, at Oakham Park, 14 years planted, it is 13 ft. high. In Berkshire, at White Knights, 38 years planted, it is 57 ft. high. In Hertfordshire, at Cheshunt, 10 years planted, it is 16 ft. high. In Staffordshire, at Trentham, it is 30 ft. high. In Suffolk, at Ampton Hall, 12 years planted, it is 16 ft. high. In Worcestershire, at Croome, 40 years planted, it is 40 ft. high.—In Ireland. In the Glasnevin Botanic Garden, 35 years planted, it is 15 ft. high; at Terenure, 8 years planted, it is 8 ft. high. In Kilkenny, at Woodstock, it is 20 ft. high.—In France, at Paris, in the Jardin des Plantes, 40 years planted, it is 45 ft. high, diameter of the trunk 1 ft., and of the head 20 ft.

Commercial Statistics. Plants, in the London nurseries, are 2s. 6d. each; at Bollwyller, 1 franc 50 cents; and at New York, 75 cents.

‡ 15. *P. BRUTIA* Ten. The Calabrian Pine.

Identification. Ten. Fl. Nap. Prod., p. 62; Synops., ed. alt., p. 66; Syll., p. 477; Lamb. Pin., vol. 3. t. 62; Lawson's Manual, p. 336; Loud. Cat., ed. 1838.

Synonymy. *P. conglomerata* Græfer Pl. Essicæ, as quoted by Lambert.

Figurings. Lamb. Pin., vol. 3. t. 62; and our figs. 2114. and 2116., from Lambert, and from a young tree in the Horticultural Society's Garden, sent there by Mr. Lambert.

Spec. Char., &c. Leaves in pairs, very long, slender, wavy. Cones sessile, crowded, ovate, smooth. Scales truncate at the apex, flattish, umbilicate. (*Lamb.*) Buds (see fig. 2114.) $\frac{3}{4}$ in. long, and $\frac{1}{2}$ in. broad; ovate, pointed, whitish, and wholly without resin; centre bud surrounded by three smaller buds. Leaves from 3 $\frac{1}{2}$ in. to 4 in. long, on the young plant in the Horticultural Society's Garden; but above 6 in. long in Mr. Lambert's figure. Sheaths, in both, less than $\frac{1}{2}$ in. in length.

Description. "A middle-sized tree, with many large spreading branches. Bark greyish brown, smooth, not cracked, but covered with depressed tubercles. Leaves in twos, rarely in threes, very long, slender, glabrous, wavy, spreading, about 9 in. long; light green, canaliculate above, convex beneath, serrulate on the margin, terminated by a small conical callous mucro; sheaths about $\frac{1}{2}$ in. long, persistent, of an ash-brown colour, membranaceous, entire round the tops; guarded at bottom with a linear-lanceolate, revolute, bright brown, thread-like, ciliated scale (metamorphosed leaf). Cones sessile, generally in clusters, ovate, smooth, brownish, 2 in. to 3 in. long. Cones truncate at the apex, flattish, trapezoidal, umbilicate, smooth, obsoletely 4-angled; umbilicus dilated, depressed, somewhat hollow, ash-coloured. (*D. Don.*) This species is nearly related to *P. h. maritima*; but it is readily distinguished both from it and *P. halepensis* by its very long wavy leaves, and by its shorter, sessile, clustered cones, with the scales depressed and slightly concave at their apex. The leaves resemble those of *P.*



2114

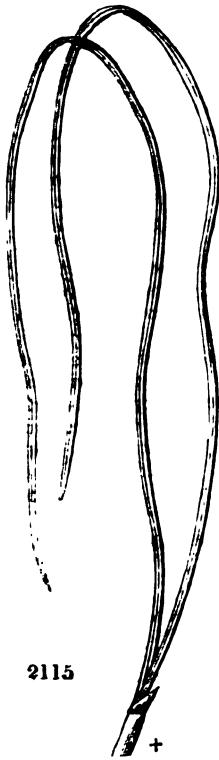

2115

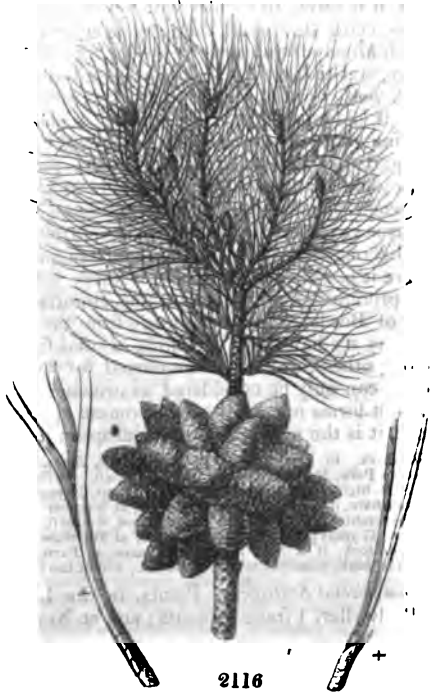

2116

Laricio; but they are more slender, and rather longer, and both species differ essentially in their cones. Sprengel has referred it to *P. Pinaster*, not even allowing it the rank of a variety; but no two species can be more distinct. The leaves in *P. Pinaster* are twice as stout, straight, and rigid, and disposed in interrupted verticels; and the cones are double the size, with the scales elevated and angular. The tree of *P. brutia* is said to attain a considerable size, and to yield timber of excellent quality." (*Lamb. Pin.*, iii, t. 82.) Mr. Lambert has raised young plants at Boyton, which he has distributed to different public and private establishments, including the Horticultural Society's Garden.

App. i. *Species of Pine having Two Leaves in a Sheath, which we cannot with certainty refer to any of the preceding Sections.*

P. Massoniana Lamb. *Pin.*, ed. 2, 1. t. 8., *N. Du Ham.*, 5. p. 243, *Willd. Sp. Pl.*, 4. p. 497., *Laws. Man.*, p. 348.; *P. nepalensis* Cels. Leaves in pairs, very long, and slender; sheaths short. Crest of the anthers dentate-lacerate. (Lamb.) Bud apparently like that of *P. sinensis*. Leaves 6 in. long, slender; sheaths $\frac{1}{2}$ in. long, white, membranaceous, with brown scales at the base. Male catkins numerous, $\frac{1}{2}$ in. long. A tree, a native of China, and probably identical with *P. sinensis*. Mr. Lambert's plate is from a specimen in the Banksian herbarium, brought by Mr. Francis Masson from the Cape of Good Hope, where it was raised from seeds which had been sent from China. Neither cones, seeds, nor living plants, have yet been introduced under the name of *P. Massoniana*; but Mr. Lawson observes, "on comparing a plant received from M. Cels, nurseryman, Paris, under the name of *P. nepalensis*, with Mr. Lambert's figure and description of *P. Massoniana*, there seems little doubt but they are the same. In habit of growth and general appearance it resembles *P. longifolia*, but differs in having only two leaves in each sheath, whereas the latter has three. The plant, however, above referred to, has not attained sufficient size to show whether its leaves will become so pendulous as those of the long-leaved East Indian pine." There is a plant of *P. nepalensis* in the pinetum at Haddo House, of which the Earl of Aberdeen has sent us a specimen, but the leaves are in threes. *P. Massoniana* Professor Don considers, as we have seen in p. 2218., nothing more than *P. Pinaster*; and, with respect to the *P. nepalensis* received from Lord Aberdeen, it is probably *P. longifolia*.

Piceus sp., from Nepal. Some cones of a pine have been kindly sent us by Mr. Paxton, which were brought home from the East Indies in 1837, by a collector sent out by His Grace the Duke of Devonshire. The cones resemble those of *P. Pinaster* in the termination of their scales, but they are much smaller; the largest is $2\frac{1}{2}$ in. long, and 2 in. broad; and the smaller ones, and the seeds and their wings, resemble *fig. 2117*. No leaves were brought home; but Mr. Paxton informs us that the general appearance of the tree, on its native hills, was like that of an old, stunted, weatherbeaten Scotch pine; it having, like that tree, dark heavy foliage, rather dense. All the trees the collector saw had that character, except one or two which were growing more freely, and had more the appearance of cedars of Lebanon; only that the branches did not spread so much at bottom; though they had the habit of that tree, the head tapering on every side, from the extremity of the bottom branches upwards to a point. The height to which the tree grows is estimated at between 30 ft. and 40 ft. As the cones bear so close a resemblance in their scales to those of *P. Pinaster* and *P. Pinea*, we have noticed them in this Appendix, rather than under any of the sections of 3 or 4-leaved pines, to which, however, the species may ultimately be found to belong. As the seeds are fresh, young plants will soon be raised; and these, in a few years, will enable us to decide at least to what section the tree belongs.



Sect. ii. *Ternâtâ*. — *Leaves 3 in a Sheath.*

A. *Cones hardly so long as the Leaves; the Scales with Prickles.*

§ v. *Tæ'da*.

Sect. Char. Leaves 3 in a sheath, longer than the cones. Cones in twos, threes, or clusters, with the scales prickly. The trunk and larger branches throw out tufts of foliage and abortive shoots, even in the thickest parts, and in every stage of the tree's growth. Natives of North America. — The kinds brought together in this section, though generally considered species, may, possibly, be only varieties. Though the pines belonging to this division are easily known by the cones, and even by the leaves and buds, when the trees are mature and seen together; yet we have found none so difficult to determine by their leaves and buds, when the plants are young. In general, the leaves of *P. Tæ'da* are longer, stronger, and of a more glaucous hue; and its buds are larger than those of any other kind in the section. *P. rigida* has shorter leaves, fewer of them, and they are less glaucous; and the buds are long, cylindrical, and blunt-pointed. *P. serótina* resembles *P. rigida* in the leaves, but these are still fewer, and the cones are egg-shaped. The *P. variabilis* of Lambert, according to his figure, is different from any of these, and in no way resembles the *P. mitis* of Michaux, of which it is said to be a synonyme. The *P. mitis* of Michaux is known with certainty at first sight, by its numerous, thickly set, and slender, short leaves; and, above all, by the

violet-coloured glaucous bloom of the shoots. (See p. 2195.) As *P. mitis* has frequently three leaves, it may possibly belong to this section, but its buds are scaly, and not resinous.

‡ 16. *P. TEXIDA* L. The Frankincense, or Loblolly, Pine.

Identification. Lin. Sp. Pl., 1419; Syst., ed. Reich., 4. p. 173; Ait. Hort. Kew., 3. p. 368; Michx. N. Amer. Syl., 3. p. 155; Lamb. Pin., 1. t. 15; Pursh Fl. Amer. Sept., 2. p. 644; N. Du Ham., 5. p. 245; Hayne Dend., p. 174; Lawson's Manual, p. 351; Bon Jard., 1837, p. 975; Lodd. Cat., ed. 1838.

Synonymes. *P. foliis ternis Gron. Virg.*, 152; *P. virginiana tenuifolia trípilis Pluk. Alm.*, 297; White Pine, at Petersburg and Richmond, in Virginia; Oldfield Pine, *Amer.*; Pin de l'Encens, *Fr. Engravings* Lamb. Pin., ed. 2., 1. t. 15; N. Du Ham., t. 75 t. 2.; Michx. N. Amer. Syl., t. 143.; our fig. 2121., to our usual scale; and figs. 2118. to 2120., of the natural size, from the Horticultural Society, Dropmore, and Syon specimens.

Spec. Char., &c. Leaves in threes, elongated. Cones often in pairs, shorter than the leaves; oblong, pyramidal, somewhat truncate at the apex; scales with sharp prickles, turned inwards. Crest of the anthers rounded. (*Lois.*) Buds, on young trees (see



2118

fig. 2118.), $\frac{3}{4}$ in. long, and $\frac{1}{4}$ in. broad; pointed, with straight sides; brownish red, and more covered with resin than any other species, except *P. Banksiana*. Buds on the full-grown tree at Syon, as in fig. 2120. Leaves (see fig. 2119.) from $5\frac{1}{2}$ in. to $5\frac{3}{4}$ in. long, rigid, bluntly pointed, channeled in the middle, with sheaths from $\frac{7}{8}$ in. to 1 in. long; brown, and faintly ringed. Cones $3\frac{1}{2}$ in. to $4\frac{1}{2}$ in. long, and from $1\frac{1}{2}$ in. to 2 in. broad; scales $1\frac{1}{2}$ in. long. Seed small; with the wing, $1\frac{3}{4}$ in. long. In the climate of London, the tree flowers in May, but in Carolina it flowers in April. The cones ripen in the August of the second year.

Variety.

‡ *P. T. 2 alopecurioides*

Ait. Hort. Kew., ed. 2., v. p. 317., the Fox-tail Frankincense Pine, is said to have the leaves spreading, and more squarrose than the species. There is a plant of this name in the Horticultural Society's Garden, which, 8 years planted, is 10 ft. high; but it does not appear different from the species. Pursh is of opinion that this variety

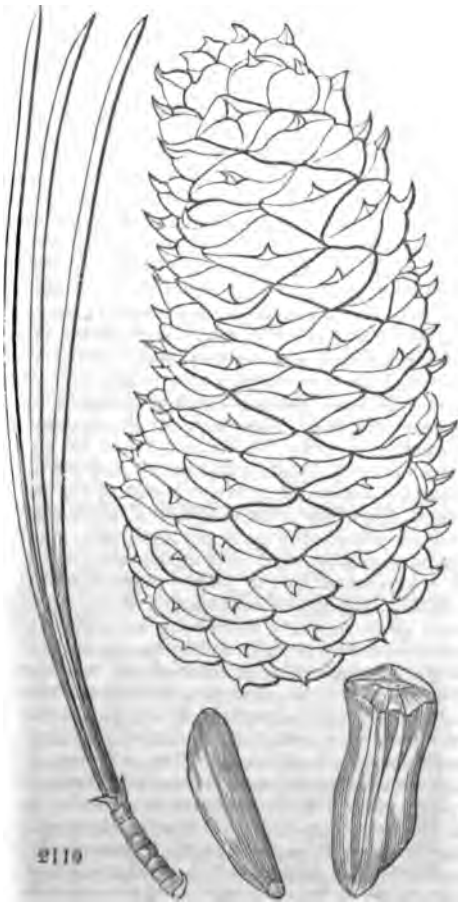

is nothing more than the *P. serotina* of Michaux, but Lambert thinks it a variety of *P. rigida*.

Description. A lofty tree, often, in America, upwards of 80 ft. high, with a trunk sometimes clear of branches to the height of 50 ft., and from 2 ft. to 3 ft. in diameter, with a wide-spreading head. The leaves are broad, pointed, flat on the upper surface, and forming a ridge below; of a fine light green, with a sheath long and whitish at first, but becoming short, thick, and brown when old. The cones are about 4 in. in length; and the scales terminate in processes which have the form of an elongated pyramid, somewhat in the manner of *P. Pinaster*; but the apex of the pyramid terminates in a thick sharp prickle, somewhat in the manner of *P. pungens*, and turned upwards. When the cone opens, the elongation of the process contracts laterally, and it then assumes the form of a regular rhomboid. The timber is said by Michaux to have a large proportion of sap wood, which arises from the rapid growth of the tree, and the consequent thickness of its annual layers. In England, in the climate of London, *P. Tæda* grows vigorously, there being large trees at Syon and at Kew, which, after being 50 years planted, produce shoots of from 9 in. to 1 ft. every year. At Dropmore, a tree, of which *fig.* 2122. is a portrait to a scale of 1 in. to 12 ft., after being 41 years planted, was, in 1837, 37 ft. high.

Geography and History. *P. Tæda*, according to Pursh, is found in barren sandy situations, from Florida to Virginia. All the woods in the southern states, he says, seem to be seeded with it; for, when any piece of clear land is neglected for any length of time, it is speedily covered with this species; and hence its name, amongst the inhabitants, of Oldfield pine. It is difficult, and in some cases almost impracticable, he adds, to recover the lands which have been overrun with young pines of this species, as the ground appears to have lost all fertile properties for any other vegetable than these trees. Michaux, whose account Pursh characterises as very correct and instructive, says that *P. Tæda* is found in the lower part of Virginia, and in the districts of North Carolina situated north-east of the river of Cape Fear, over an extent of nearly 200 miles; always growing in dry sandy soil. On spots consisting of red clay mixed with gravel, it is supplanted by the yellow pine (*P. mitis Michx.*), and by different species of oak; the two pines regularly alternating according to the varieties in the soil; and frequently vanishing and reappearing at intervals of three or four miles. "In the same parts of Virginia," he adds, "this species exclusively occupies lands that have been exhausted by cultivation; and, amid forests of oak, tracts of 100 or 200 acres are not unfrequently seen covered with thriving young pines. In the more southern states, it is the most common species after the long-leaved pine (*P. australis*); but it grows only in the brush swamps, or long narrow marshes that intersect the pine barrens, and near the creeks and rivers, where the soil is of middling fertility, and susceptible of improvement; such is the vicinity of Charleston, in South Caro-



2120



2121

line, which is covered to the distance of five or six miles with loblolly pines. (Michx.) *P. Tæda* was introduced into England before 1713, by Bishop Compton; and there are fine specimens of the tree at Syon, Kew, and more especially, at Pain's Hill. Of one of the trees at Syon, and of one of those at Pain's Hill (the latter, doubtless, the handsomest tree of the species in Europe), portraits are given in our last Volume. As seeds are easily procured from New York, the species is not uncommon in the London nurseries; and it is more frequent in collections than most other American pines. It grows freely in the neighbourhood of Paris, and ripens cones there; it also stands the open air in the south of Germany, and as far north as Berlin.

Properties and Uses. The wood, as already observed, is porous, and not very durable; though the fineness of its grain, and consequently its durability, vary according to the soil on which it is grown. In some parts of Virginia, three fourths of the houses are built with logs of this pine; and it is there even used for laying the ground floors, instead of the yellow pine (*P. mitis*). These floors are formed of boards only 4 in. wide; and, though they are strongly nailed, they soon shrink, and become uneven; a result which does not take place when the long-leaved pine (*P. australis*) is used; the concentric circles of which, Michaux observes, are twelve times as numerous in the same space as those of *P. Tæda*. On the whole, the wood of this latter tree is little esteemed in America for its timber; but it affords turpentine in abundance, though in a less fluid state than that of the long-leaved pine. Michaux suggests the idea of trying it along with the pinaster on the plains of Bordeaux, and employing it for the same purposes as that tree.

Statistics. There is a tree at Syon 75 ft. high; one at Kew between 40 ft. and 50 ft. high; some at Whitton, 60 ft. high; and a number at Pain's Hill, 60 ft. to 70 ft. high: at Dropmore, it is 38 ft. high. Price of cones, in London, 1s. per quart; and of plants, 5s. each: at Bollwyller, plants are 2 francs each.

2 17. *P. RIGIDA* Mill. The rigid, or Pitch, Pine.

Identification. Mill. Dict., No. 10; Du Roi Herbik., 2. p. 60; Wang. Beyt., p. 41; Marshall Arb. Amer., p. 101; Lamb. Pin., ed. 2., t. 16, 17; Michx. N. Amer. Syl., 3. p. 150; Pursh Fl. Amer. Sept., 2. p. 643; Hayne Dend., p. 174; Lawson's Manual, p. 662; N. Du Ham., p. 244; Bon Jard., 1837, p. 572; Lodd. Cat., ed. 1836.

Synonymes. *P. Tæda rigida* B. Alt. Hort. Kew. 3. p. 368; Willd. Berol. Baumz., p. 210; *P. canadensis trifida* Du Ham. Arb., 2. p. 126; ? *P. Tæda* s. Foir. Dict., 5. p. 340; ? three-leaved Virginian Pine, San Pine, black Pine; Pin hérisseé, Pin rude, Fr.

Encroachings. Lamb. Pin., ed. 2., t. 16, 17; N. Du Ham., 5. t. 74; Michx. N. Amer. Syl., vol. 3. t. 144; our fig. 2123, to our usual scale; and figs. 2123. to 2125., of the natural size, from Dropmore specimens.

Spec. Char., &c. Leaves in threes. Cones ovate-oblong, in threes or four, much shorter than the leaves; their scales terminated by a rough thorny point. Male catkins elongated, with the crest of the anthers dilated, and roundish. (Lam.) Buds, on young trees (see fig. 2123.), from $\frac{1}{4}$ in. to $\frac{1}{2}$ in. long, $\frac{1}{8}$ in. broad, pointed, brown, and covered with resin; on the full-grown trees at Dropmore as in fig. 2125. Leaves (see fig. 2124.) from 3 $\frac{1}{2}$ in. to 4 $\frac{1}{2}$ in. long; sheath $\frac{1}{2}$ in. long, white at first, and afterwards becoming darker, but scarcely black. Cones from 2 $\frac{1}{2}$ in. to 3 in. long, and from 1 $\frac{1}{2}$ in. to 1 $\frac{3}{4}$ in. broad; scales 1 $\frac{1}{2}$ in. long, terminating in depressed quadrilateral pyramids, ending in a prickle, pointing outwards. Seed little more than $\frac{1}{4}$ in. long; but, with the wing, from $\frac{1}{2}$ in. to $\frac{3}{4}$ in. long. Cotyledons, ?

Variety. According to Mr. Lambert, *P. T. alopecuróidea* Ait. is a variety of *P. rigida*, characterised by its much shorter and stouter leaves, and its ovate-oblong, much narrower, and aggregated cones. (Lamb. Pin., ed. 2., no. 17.)

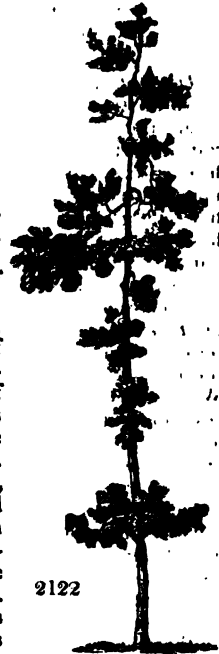

2122

2123

Description. The pitch pine, in America, Michaux informs us, varies, according to soil and situation, from 12 ft. or 15 ft. to 70 ft. or 80 ft. in height. "The buds are always resinous; and its triple leaves vary in length from $1\frac{1}{2}$ in. to 7 in., according to the degree of moisture in the soil. The male catkins are 1 in. long, straight, and winged, like those of the pond pine (*P. serotina*). The size of the cones depends on the nature of the soil, and varies from less than 1 in. to more than 3 in. in length; they are of a pyramidal shape, and each scale is pointed with an acute prickle of about $\frac{1}{2}$ in. long. Whenever these trees grow in masses, the cones are dispersed singly over the branches; and they shed their seeds the first autumn after they are mature; but, on solitary trees, the cones are collected in groups of four, five, or even a larger number, and will remain on the trees closed for several years." (*Mitch.*) This species has a thick, blackish, deeply furrowed bark. It is remarkable for the number of its branches, which occupy two thirds of its trunk, and render its wood extremely knotty. The concentric circles are widely distant; and three fourths of the wood

of the larger trees consists of sap wood. On mountains and gravelly lands, the wood is compact, heavy, and surcharged with resin; whence is derived the name of pitch pine. In swamps, on the contrary, it is light, soft, and composed almost wholly of sap wood; whence it is called the sap pine. In British gardens, the tree is of as rapid growth as *P. Theda* and *P. pungens*; the specimen at Dropmore, after being 41 years planted, being upwards of 31 ft. high.

Geography and History. According to Pursh, *P. rigida* is found on the plains from New England to Virginia, growing, in favourable situations, to a very large tree, and either in dry soil, or in very wet low ground. Michaux states that it is found throughout the whole of the United States, with the exception of the maritime part of the Atlantic districts, and the fertile regions west of the Alleghany Mountains; but most abundantly where the soil is meagre. The most northern points at which Michaux observed it were, the vicinity of Brunswick, in the district of Maine; and Bur-

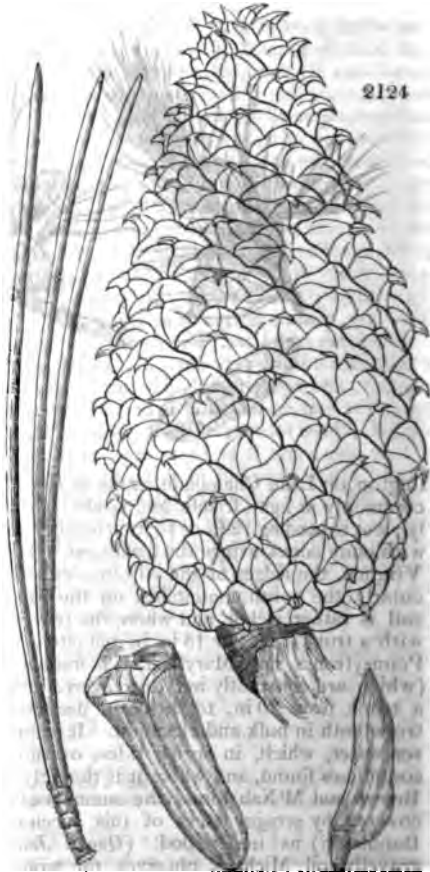

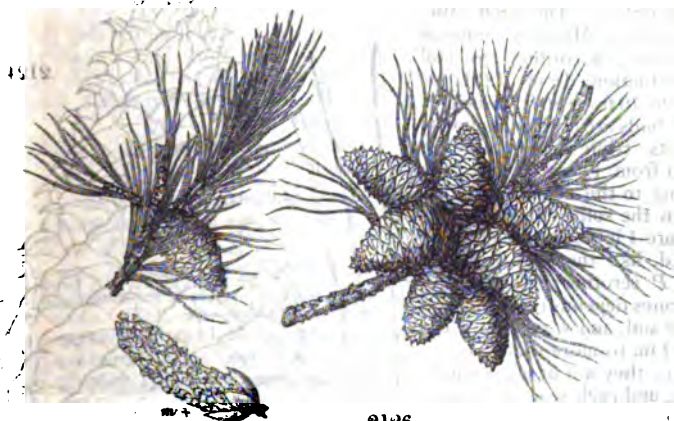

2126

lington, on Lake Champlain, in the state of Vermont. In these places, it grows commonly in light, friable, and sandy soils, which it occupies almost exclusively; not exceeding 12 ft. or 15 ft. in height; and where its slender branches, laden with puny cones, evince the feebleness of its vegetation. In Pennsylvania and Virginia, the ridges of the Alleghanies are sometimes covered with it; particularly the south mountains, on the ridge called Saddle Hill, where the soil is rather richer, and where the tree attains the height of 35 ft. or 40 ft., with a trunk 12 in. or 15 in. in diameter. In the lower parts of New Jersey, Pennsylvania, and Maryland, it is frequently seen, in the large cedar swamps (which are constantly miry, or covered with water), 70 ft. or 80 ft. high, with a trunk from 20 in. to 28 in. in diameter, and exceeding the surrounding trees both in bulk and elevation. It supports a long time the presence of sea water, which, in spring tides, overflows the salt meadows, where it is sometimes found, and where it is the only species of the pine tribe. Messrs. Brown and M'Nab found the summits of the Alleghany Mountains entirely covered by scraggy trees of this species, with dwarf scrub oak (*Quercus Bannisteri*) as underwood. (*Quart. Journ. of Agri.*, v. p. 604.) On dry gravelly soil, Michaux observes, the wood of *P. rigida* is knotty; and, in humid situations, it is of so poor a quality, as to be unfit for works which require strength or durability. This species seems to have formerly abounded in Connecticut, Massachusetts, and New Hampshire; for, from the beginning of the eighteenth century, till 1776, these states furnished Britain with a considerable quantity of tar. About the year 1705, a misunderstanding having taken place between Great Britain and Sweden, from which latter country the British government had principally drawn its supply of tar, Great Britain encouraged this branch of industry in the northern part of America, by a premium of 1*l.* sterling for every barrel of tar made from dead wood, and 2*l.* for every barrel made from green wood; in consequence of which, and of this tree furnishing tar abundantly, its destruction has been so rapid, that it is now rarely found in the northern states. *P. rigida* was cultivated in England by the Duke of Bedford, previously to 1759; and, as the cones are frequently imported, it is not uncommon in collections of the genus. There are old trees at Syon and Pain's Hill, from 40 ft. to 50 ft. high; and one at Dropmore, 40 years planted, which, in 1837, was 31 ft. high. The specimen in the arboretum at Hackney is 10 ft. 6 in. high; and one in the Horticultural Society's Garden, after being 6 years planted, is 5 ft. high.

Properties and Uses. In some parts of the Alleghanies, where this tree abounds, houses are built of it; and the wood, if it is not covered with paint, is readily recognised by its numerous knots. It is thought better than the

yellow pine for floors that are frequently washed; as the resin with which it is impregnated renders it finer and more durable. It is used for ship pumps, and as fuel by the bakers and brick-makers of New York and Philadelphia; and from the roots is procured lampblack. The principal use of this tree is, however, to furnish tar and turpentine. The essence of turpentine, used in most parts of America for painting, is prepared from this tree.

Commercial Statistics. Price of cones, in London, 2s. per quart. Plants, at Bollwyller, are 1 franc 50 cents each; and at New York, 50 cents.

‡ 18. *P. (R.) SEROTINA Michx.* The late, or Pond, Pine.

Identification. Michx. Fl. Amer. Bor., 2. p. 205; Michx. Arb., 1. p. 86; N. Amer. Syl., 2. p. 162; Pursh Fl. Amer. Sept., 2. p. 643; N. Du Ham., 5. p. 246; Lamb. Pin., ed. 2., 1. t. 18; Lawson's Manual, p. 353.

Synonymy. ? *P. Tæda alopecuroides* Ait. Hort. Kew., ed. 2., 5. p. 317.

Engravings. Michx. Arb., 1. t. 7; N. Amer. Syl., 3. t. 142; N. Du Ham., 5. t. 75. f. 1; Lamb. Pin., ed. 2., 1. t. 18; our figs. 2130, to our usual scale; and figs. 2127, to 2129, of the natural size, from the Horticultural Society and Dropmore specimens, and from Michaux.

Spec. Char., &c. Leaves in threes, very long. Male catkins erect, incumbent. Cones ovate; scales having very small mucros. (*Michx.*) Buds, on young trees (see fig. 2128.), from $\frac{3}{16}$ in. to $\frac{1}{4}$ in. in length, and from $\frac{1}{16}$ in. to $\frac{1}{8}$ in. in breadth; conical, dark brown, and very resinous; buds on old trees as in fig. 2127. Leaves (see fig. 2129.), in the Dropmore specimens, from 4 in. to 6 in. long; in Michaux's figure, upwards of 8 in. long. Cones $2\frac{1}{2}$ in. or 3 in. long, and $1\frac{1}{2}$ in. or 2 in. broad; egg-shaped; scales $\frac{7}{8}$ in. long, and $\frac{3}{4}$ in. broad, with the apex depressed, and terminating in a slender prickle. Seed very small; with the wing, from $\frac{3}{4}$ in. to $\frac{7}{8}$ in. in length. Cotyledons, ? The cones and leaves of the trees of this name at Dropmore, and the circumstance of there being trees at Pain's Hill with cones of different sizes and shapes, but all on three-leaved pines, and all evidently of the *Tæda* family, induce us to believe that *P. rigida* and *P. serotina* are only different forms of the same species.

Description, &c. The pond pine, according to Michaux, rarely exceeds 35 ft. or 40 ft. in height, with a branchy trunk from 15 in. to 18 in. in diameter. The leaves are generally 5 in. or 6 in. long, and sometimes more. The male catkins are straight, and about $\frac{1}{2}$ in. long. The cones are commonly in pairs, and opposite to each other; they are about $2\frac{1}{2}$ in. long, nearly 2 in. in diameter, and egg-shaped; the scales are rounded at their extremities, and armed with fine short prickles, which are easily broken off, so that in some cases no vestiges are left of their existence. The cones arrive at maturity the second year; but they do not shed their seeds till the third or fourth



2137



2128

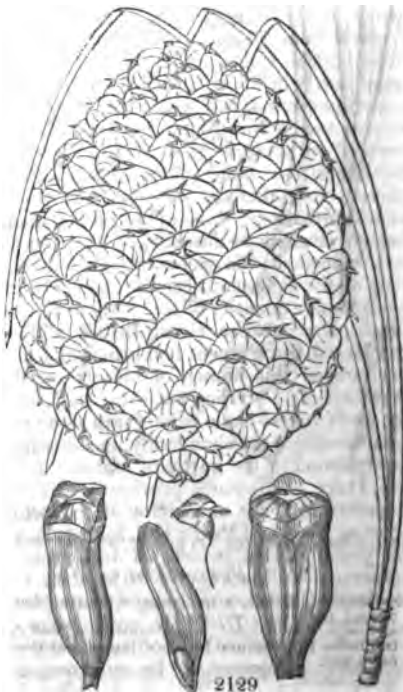

2129

year; whence the specific name. Pursh, who suspects this species to be only a variety of *P. rigida*, says that it grows on the edges of ponds and swamps from New Jersey to Carolina. Michaux observes that it is generally found in the maritime parts of the southern districts; but that "it grows occasionally in other parts of the United States, on the borders of ponds, and in the black and miry soil of the small swamps which form the habitat of the loblolly bay (*Gordonia lasianthus*), the tupelo (*Nýssa bicolor*), and the small magnolia (*Magnolia glauca*). This species is sometimes found, also, in abandoned fields near the swamps; but the dryness of the soil occasions no difference in its form. This observation, Michaux adds, is of importance, as *P. serótina* is frequently confounded with *P. rigida*, which it strikingly resembles. The timber is found to consist of more than one half of sap wood; and for this reason it is useless at home, and deservedly neglected abroad." (*Michx.*) In England, it forms, like the other



kinds of *P. Tæda*, an interesting addition to the pinetum, growing as freely at Syon, Pain's Hill, and Dropmore, as *P. rigida* (or *P. Tæda*. The tree at Dropmore (of which a portrait is given in our last Volume) was, in 1837, 32 ft. high, that at Syon was 25 ft. high, and one at Kenwood was 30 ft. high.

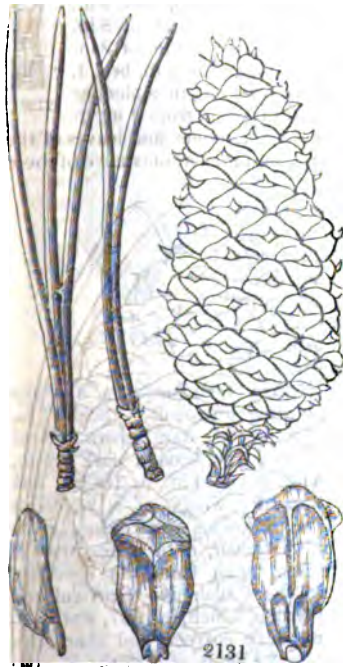

P. variabilis Lamh. Pin., ed. 2, 1. t. 14., and our fig. 2131., of the natural size, from Lambert's plate. Mr. Lambert describes this pine as having the leaves in twos and threes, 2 in. long, channeled, the margins and nerves rough, and the apexes sub-keelshaped; the sheaths short, straight, and but little wrinkled. The cones solitary, recurved, pendulous, narrow-ovate, muricate; spines subincurved, with the scales dilated in the middle. He has only seen two trees of this species in England; one at Pain's Hill, and the other at Kew. (*Lamb.*) The one at Kew no longer exists; and the only trees at Pain's Hill, that we could see, with cones resembling those in Mr. Lambert's plate, had three leaves, and appeared to us to belong to *P. Tæda*. The buds in Mr. Lambert's figure appear to be resinous, but those of *P. variabilis* at Dropmore, which we feel confident is the *P. mitis* of Michaux (which Mr. Lambert makes a synonyme of his plant), are scaly, with the scales reflexed, as in fig. 2073, in p. 2195. The young shoots in Mr. Lambert's plate are green, but in the Dropmore plant they are of the same violet glaucous hue as those of *P. Inops*; a character so remarkable that it cannot be mistaken, and which, Michaux says, belongs to no other pine of the United States but *P. Inops* and *P. mitis*. (*N. Amer. Syl.*, 3. p. 150.) It is found also in *P. Sabina* and *P. Coditeri*; but with these species Michaux was not acquainted.

§ vi. *Ponderosa*.

Sect. Char. Leaves very long, strong, somewhat flexuose.

♀ 19. *P. PONDEROSA* Dougl. The heavy-wooded Pine.

Identification. Douglas's specimens in the Horticultural Society's herbarium; *Lawsol's Manual*, p. 324; *Lodd. Cat.*, ed. 1836. *Engraving.* Our fig. 2135., to our usual scale; and figs. 2132. to 2134., of the natural size; from the tree in the Horticultural Society's Garden, and Douglas's specimens in the Horticultural Society's herbarium.

Spec. Char., &c. Leaves three in a sheath, much longer than the cones, flexible, tortuous, with short sheaths; crest of the anthers rounded, entire.



2132

Cones ovate, reflexed, with the apices of the scales flattened, with a raised process in the middle, terminating in a conical, minute, recurved spine, slightly quadrangular. Buds, in Douglas's specimen, $\frac{7}{8}$ in. long and $\frac{3}{4}$ in. broad; cylindrical, with straight sides, rounded like a dome at the extremity, but with a prominent blunt point; dark brown, and covered with resin. Buds, on the living tree in the Horticultural Society's Garden (see fig. 2132.), from 1 in. to $1\frac{1}{2}$ in. long, and from $\frac{3}{4}$ in. to $1\frac{1}{2}$ in. broad; smooth, cylindrical, with a long point; reddish brown, and covered with a fine white bloom, consisting of fine particles of resin, surrounded by two or more smaller buds. Leaves disposed in parallel spirals; in Douglas's specimen (see fig. 2133.), from 9 in. to 11 in. long; 3 in a sheath, which is from $\frac{3}{4}$ in. to 1 in. in length, with numerous fine rings; scales of the leaves persistent on the wood, even of two years' or three years' growth. Leaves, on the living plant, from 7 in. to 9 in. long. The cone (see fig. 2134.), in Douglas's specimen, is deformed, and



2134

very imperfectly developed; it is only 3 in. long, and $\frac{3}{4}$ in. broad. The scales are terminated in flattened processes, scarcely ribbed in any direction. In the centre of the process is a protuberance, large in proportion to the scale, which terminates in a sharp prickle, pointing outwards. Scale 1 in. long, and $\frac{3}{4}$ in. broad; dark brown. Seed $\frac{5}{16}$ in. long, and $\frac{3}{8}$ in. broad; dark brown, with the wing nearly 1 in. in length, and $\frac{3}{8}$ in. in breadth; wings of a yellowish brown. The following description, given in Lawson's *Manual*, of a young tree of *P. ponderosa*, taken from the specimen growing in the Caledonian Horticultural Society's Garden, which, in 1837, was 15 ft. high, is at once correct and characteristic:—"In its habit of growth, *P. ponderosa* seems to surpass all others of the genus for strength and luxuriance. The branches are few, regularly verticillated, horizontal, and seem inclined to assume a pendulous or drooping habit as the tree becomes old; central or top shoot often more than an inch in diameter, and of proportionable length. Buds large, and free from resin. Leaves thickly set, 9 in. to 1 ft. or 1 ft. 2 in. in length; thick, rigid, and nearly straight; rounded on the exterior, and having a longitudinal prominent rib, together with minute channels, on the in-

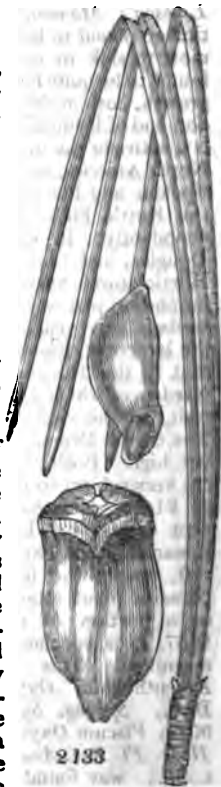

2133

terior side; smooth, with very indistinctly serrated margins; sheaths short, of a dull blackish colour, and lacerated or torn at their extremities." (Lamson's Manual, p. 355.)

The timber is said to be so heavy as almost to sink in water. The tree is found to be quite hardy, and of rapid growth, both in the climate of London and of Edinburgh. *P. ponderosa* is a native of the north-west coast of North America, on the banks of the Spokan and Flathead rivers, and on the Kettle Falls of the Columbia, abundantly. It was discovered by Douglas, and sent by him to the Horticultural Society in 1826. A number of plants were raised from seeds in that year, and distributed: the largest of these we believe to be that in the Horticultural Society's Garden, of which fig. 2136. is a portrait, to the scale of 1 in. to 4 ft. The tree at Dropmore was, in 1837,

9 ft. high. Both this tree, and that in the Horticultural Society's Garden, are very subject to the attacks of the *Hylurgus piniperda*, already described, p. 2141.; and the specimen

sent home by Douglas is remarkable for having a large tuft, among the leaves, of a parasitic plant attached to it; of a portion of which fig. 2137. is a specimen slightly magnified. This plant, the *Areuthobium Oxycedri* of Bieb., *Spreng. Syst.*, iii. p. 901.; *Fiscum Oxycedri Dec.*, *Hook. Fl. Bor. Amer.*, p. 271. t. 99.; was found by Douglas on *Pinus ponderosa*, on the west side of the Rocky Mountains; and both by Douglas and Drummond "on *P. Banksiana*, from the Spokan river on the west side of the Rocky Mountains, in lat. 47° to the Rocky Mountains, and thence to Hudson's Bay on the east, in lat. 57°. Mr. Douglas entertained an idea that the specimens in his herbarium of this curious parasite, found on *P. ponderosa*, were different from those found on *P. Banksiana*; but the only

difference consists in the latter being loaded with female, the former with male, flowers, which certainly gives a very different appearance to the extremities of the numerous branches. It is remarkable too, that all Mr. Drummond's specimens (and they were all found upon *P. Banksiana*)

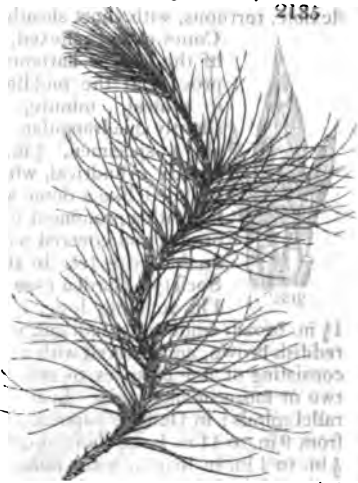

are male plants. These and the plants of Mr. Douglas have been carefully compared with European ones found growing on the *Juniperus Oxycedrus*, some from the south of France (in Languedoc, gathered by M. Bory de Saint-Vincent), and others from Mt. Caucasus, communicated to me by Mr. Prescott, and I must confess, I cannot perceive any specific difference in them whatever. In general, but not always, those from the old world are either greener or blacker when dry; and the American more yellow." (*Hook. Fl. Bor. Amer.*, i. p. 278.) *Pinus ponderosa*, which is, perhaps, more hardy than the *pinaster*, and is of equally rapid growth, has a noble appearance, even when a young tree; and, together with *P. Sabiniana* and *P. Coulteri*, equally noble trees, and apparently as hardy and of as rapid growth, well deserves a place in every pinetum. Price of the plants, in the London nurseries, 2s. each.



B. Cones having the Scales hooked.

§ vii. *Sabinianæ*.

Sect. Char. Cones large, with the apex of the scales elongated and hooked.

† 20. *P. SABINIANA* Douglas. Sabine's, or the great prickly-coned, Pine.

Identification. Lamb. Pin., ed. 2, t. 80.; Lawson's Manual, p. 353.; Lodd. Cat., ed. 1836.
Engravings. Lamb. Pin., ed. 2, t. 80.; our fig. 2142, to our usual scale; and fig. 2137, to the natural size, from the tree in the Horticultural Society's Garden, and Lambert.

Spec. Char., &c. Leaves in threes, very long. Cones ovate, echinate, very large. Scales long, awl-shaped, incurved, and spiny at the apex. (*Lamb. Pin.*) Buds,

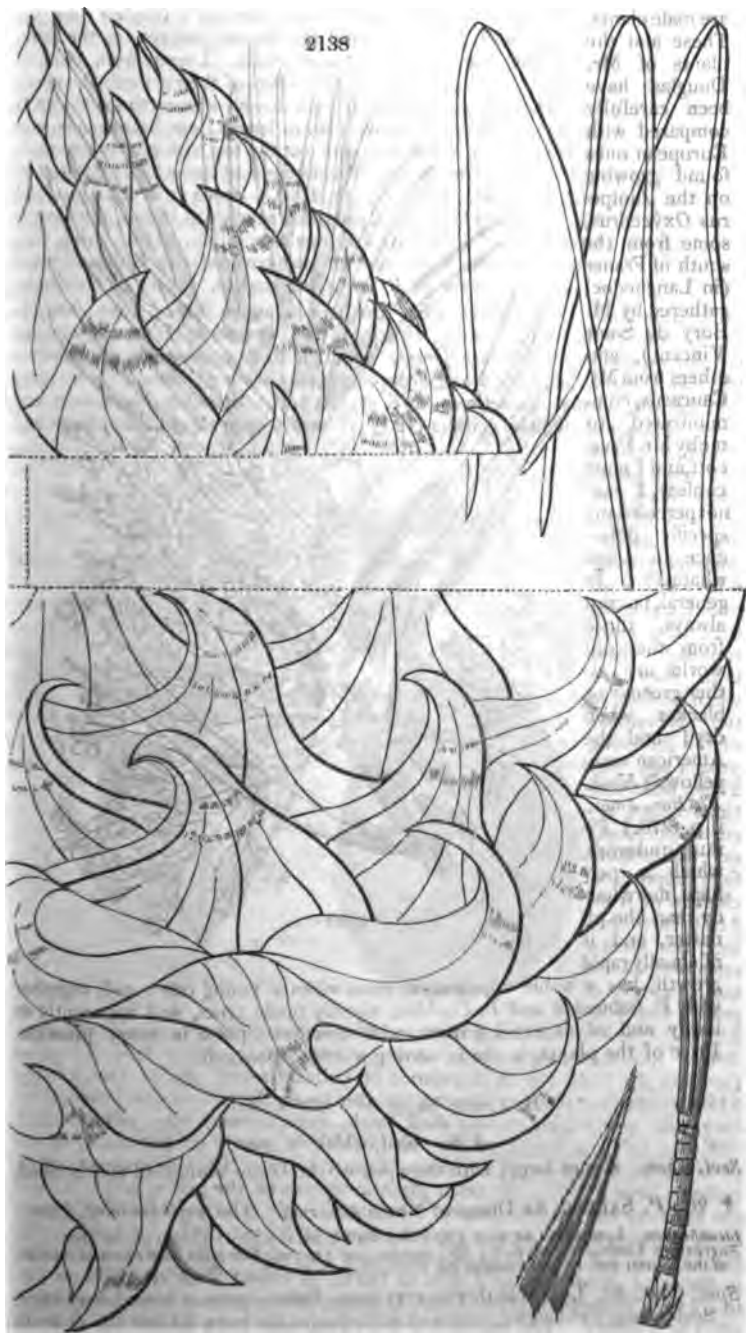



2139

on the tree in the Horticultural Society's Garden (see fig. 2139.), nearly 1 in. long, and $\frac{3}{4}$ in. broad; convex on the sides, imbricated, but not covered with resin. Leaves from 10 in. to 1 ft. in length; glaucous in every stage of their growth, flexuose; and, when full-grown, partly bent downwards, as those shown in fig. 2142. Sheaths above 1 in. in length, membranaceous, ash-brown, shining, and nearly entire at the top, with numerous ribs; scales of the cones, in the specimens sent home by Douglas, 2 in. long and $1\frac{1}{2}$ in. broad (see fig. 2140.). Seeds (*a* in fig. 2140., and *b* in fig. 2141) above 1 in. long, and nearly $\frac{1}{2}$ in. broad, much larger than those of *P. Coulteri* shown at *a* in fig. 2141.; wing very short. Shoots of the current year covered with violet-coloured bloom, like those of *P. inops*, but darker. Native of California.

Description. Douglas describes the leaves as in threes, very rarely in fours, from 11 in. to 14 in. long, sharp, round, and smooth on the outside, angular on the inside, serrated, more widely and conspicuously so towards the point, erect, but flaccid and drooping during winter; sheath $1\frac{1}{2}$ in. long, light brown, chaffy, sometimes torn at the top. Stipules lanceolate and rigid. Male and female catkins erect. Flowers appearing in February and March.

Cones of a bright green when young; at the end of the first season, measuring from 6 in. to 8 in. round, and being then of a more rounded form than they are when perfect, in the November of the following year (see fig. 2138.: when mature, ovate, recurved, pressing on the shoots for support, in clusters of from 3 to 9, surrounding the stem; remaining on the tree for a series of years; and from

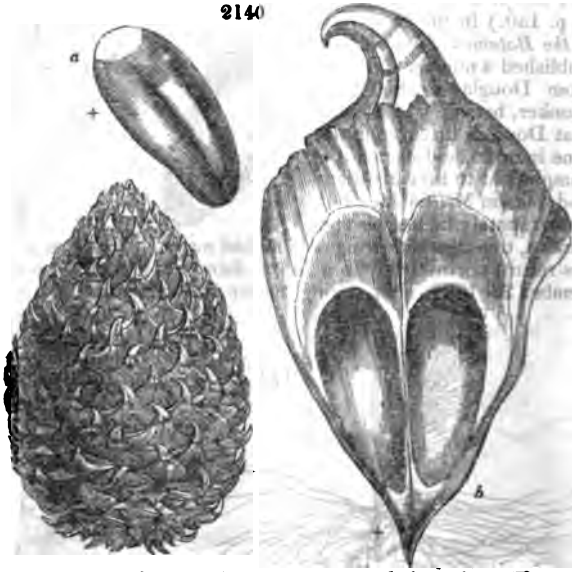

2140

9 in. to 11 in. long, and from 16 in. to 18 in. round; some, however, are larger. Scales spatulate, $2\frac{1}{2}$ in. long, having a very strong, sharp, incurved point (see *b* in fig. 2140.) with abundance of pellucid resin. Seeds (see *a* in fig. 2140.) somewhat oblong, tapering to the base; flattish on the inside, 1 in. long, and nearly $\frac{1}{2}$ in. broad; shell thick, hard, brown; wing yellow, short, stiff, and half the length of the seed, which it nearly encompasses; kernel pleasant to the taste. Cotyledons from 7 to 12. The tree does not attain quite so large a size as the other gigantic species of the genus, which inhabit the northern and western parts of North America. The trees are of a tapering form, straight, and of regular growth; from 40 ft. to 120 ft. in height, with trunks from 2 ft. to 12 ft. in circumference (or, as Douglas states in his letter to Sir W. J. Hooker, from 110 ft. to 140 ft. in height, with trunks from 3 ft. to 12 ft. in diameter), clothed with branches to the ground when standing far apart or solitary. The largest and most handsome trees inhabit the aqueous

vegetable deposits on the western flank of the Cordilleras of New Albion, at a great elevation above the level of the sea, and 1600 ft. below the verge of perpetual snow, in the parallel of 40° n. lat. On the less elevated mountains near the coast, where the temperature is higher, but more uniform, in the parallel of 31° north, in decomposed granite schistus, or gravelly soils, the trees are smaller and few, inhabiting the summits of the mountains only. The wood is white, soft, even-grained, and perhaps not very durable. (*Lamb. Pin.*, t. 80.; and *Comp. to the Bot. Mag.*, ii. p. 150.) In the *Companion to the Botanical Magazine* are published a number of letters from Douglas to Sir W. J. Hooker, by which it appears that Douglas discovered this pine in 1826, and named it in compliment to his early friend and patron Mr. Sabine; but, unfortunately, he lost his specimens, together with the notes he had made, in crossing a rapid stream, on his return northward. In a letter dated Monterey, Upper California, November 23. 1831, after stating that he had found another tree of this species,

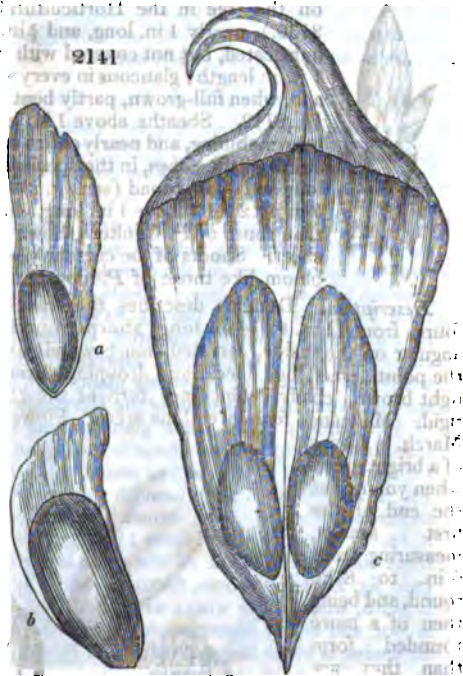

he says, "I sent to London a detailed account of this most beautiful tree, to be published in the *Horticultural Transactions*." This account never arrived; but the cones and spe-

cimens were received in 1832; and plants were raised from the seeds, in the Horticultural Society's Garden, that year. Of one of these, which, in 1837,

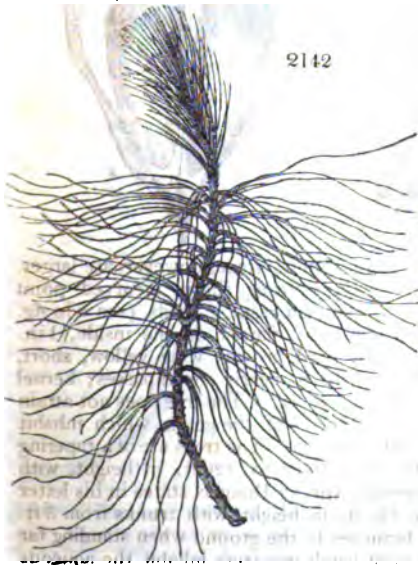

cimens were received in 1832; and plants were raised from the seeds, in the Horticultural Society's Garden, that year. Of one of these, which, in 1837,

was 4 ft. 6 in. high, *fig. 2143.* is a portrait, to a scale of 1 in. to 4 ft. There is a plant at Dropmore, which, in 1837, was 5 ft. 6 in. high. The species appears to be as hardy as the pinaster.

‡ 21. *P. (S.) COULTERI* D. Don. Coulter's, or the great hooked, Pine.

Identification. Don in Lin. Trans., 17. p. 440.; Lamb. Pin., 3. t. 83.

Synonymes. *P. Sabiniæna* var. *Hort.*; *P. macrocarpa* Lindl. MS.

Engravings. Lamb. Pin., 3. t. 83.; our *fig. 2146.* from Lambert, *fig. 2141.* from the dried cone in the Horticultural Society's herbarium, and *figs. 2144.* and *2145.* from the young plants in the Horticultural Society's Garden.

Spec. Char., &c. Leaves in threes, very long, compressed; sheaths ragged. Cones oblong, solitary, very large; scales wedge-shaped, with the apex elongated, thickened, lanceolate, mucronate, compressed, hooked. (*D. Don.*) Buds, on the tree in the Horticultural Society's Garden (see *fig. 2144.*), 1 in. long, and from $\frac{3}{4}$ in. to $\frac{5}{8}$ in. broad; conical, pointed, convex on the sides, imbricated; the scales of the buds adpressed, brown, and not covered with resin. Leaves of the young plants 9 in. long, and of the dried specimens in the herbarium of the Horticultural Society, upwards of 10 in. long; of the same glaucous hue as those of *P. Sabiniæna*, but not turned downwards at any stage of their growth. Cones (see *fig. 2146.*, to our usual scale) sent home by Douglas 1 ft. in length, and 6 in. in breadth; scales of the cones 3 in. long, and from $1\frac{1}{4}$ in. to $1\frac{1}{2}$ in. broad. Scales (see *fig. 2141. c*) from $3\frac{3}{4}$ in. to 4 in. long, and from $1\frac{1}{2}$ in. to $1\frac{3}{4}$ in. broad; in *fig. 2146.*, at *a*, a front view of the hook of the scale is given, of the natural size. Seed (see *fig. 2141. a*) brown, flattish, from $\frac{1}{2}$ in. to $\frac{3}{4}$ in. in length, and $\frac{3}{4}$ in. in breadth, without the wing; with the wing, 1 in. in length; wing stiff, light brown, and nearly encompassing the seed. Cotyledons,? The seed of *P. Sabiniæna* is much larger than that of *P. Coulteri*, as shown at *a* in the same figure. Shoots of the current year covered with a violet-coloured glaucous bloom, like those of *P. inops*, but darker. Native of California, on mountains.

Description. A large strong-growing tree, from 80 ft. to 100 ft. high. Bark brownish. Branches large; top spreading. Branchlets knotted, and tubercled from the callous bases of the stipular scales; about 1 in. in thickness. Leaves in threes, rarely in fours or fives, about 9 in. long, incurved, somewhat compressed, mucronate; 2-furrowed above, flattish beneath, slightly serrated on the margin, and on the elevated line along the middle; sheaths $1\frac{1}{2}$ in. long, about the thickness of a crow-quill, swelling at the tips. Scales of the stipules ovate-lanceolate, acuminate, cartilaginous, bright brown, shining, adpressed; margin scarious, white, thread-like, and torn; with the lower ones shorter, and keel-shaped. Stipules larger, much acuminate, hooded at the base, callous, indurated, and persistent. All the cones large, conical-oblong, 1 ft. and more in length, 6 in. in diameter near the middle, and weighing about 4 lb. Scales wedge-shaped, elongated at the apex, lanceolate, mucronate, compressed on both sides, obsoletely quadrangular, incurved and hooked, very thick, indurated, smooth, shining, brownish, acute at the margin, $\frac{1}{2}$ in. to $\frac{3}{4}$ in. long; the lower ones longer, deflexed, and spreading (*Lamb.*)



2144



2145



This tree was discovered by Dr. Coulter, in what year is not stated; but, if we are correct (and Professor Don thinks we are) in considering it the same as *P. Sabiniæna* var., seeds and specimens were sent home by Douglas in 1832, though unaccompanied by any description or historical particulars; his papers, which he had despatched by another ship, having been lost. Dr. Coulter found it on the mountains of Santa Lucia, near the mission of San Antonio, in lat. 36°, within sight of the sea, and at an elevation of from 3000 ft. to 4000 ft. above its level. It was growing intermixed with *P. Lambertiana*, and rising to the height of from 80 ft. to 100 ft., with large, permanent, spreading branches, and a trunk 3 ft. or 4 ft. in diameter. Its leaves are broader than those of any other pine; and the cones, which grow singly, are the largest of all, being often more than 1 ft. long, and 6 in. in diameter, and weighing about 4 lb. The spinous processes of the scales of the cone are very strong, hooked, and compressed, 3 in. or 4 in. in length, and about the thickness of one's finger; characters which essentially distinguish it from *P. Sabiniæna*. (*Non* in Linn. *Trans.*) At the suggestion of Mr. Lambert, Professor Don named this species after Dr. Coulter (who appears to have discovered it about the same time as Douglas), "who is no less distinguished for his scientific acquirements, than for the excellent qualities of his mind." Cones and specimens were sent home by Douglas in 1832, and plants were raised from the seed in the following year; one of these in the Horticultural Society's Garden, of which fig. 2147. is a portrait, was, in September, 1837,

7 ft. high. In its general appearance, it resembles *P. Sabina*; but it is readily distinguished from that species by the upright character of its foliage. Both species have the buds of the same form and colour; the leaves of the same beautiful glaucous hue in every stage of their growth; the young shoots covered with a violet glaucous bloom, like those of *P. inops* and *P. mitis*; and both retain their leaves till the summer of the third year. The colour and form of the seeds in the two kinds are exactly the same; but the larger cone has the smaller seeds. To us, it appears that they are only varieties of one species; but, if they are so, they are as well worth keeping distinct as any species whatever. They may, indeed, be described as of surpassing beauty; and, what adds greatly to their value, they appear to be quite hardy.



† 22. *P. LONGIFOLIA* Roxb. The long-leaved Indian Pine.

Identification. Lamb. Pin., ed. 2, l. t. 26, 27.; Royle Illust.; Lawson's Manual, p. 355.; Bon Jard., ed. 1837, p. 976.

Engravings. Lamb. Pin., ed. 2, l. t. 26, 27.; Royle Illust., t. 85. f. 2.; our fig. 2151, to our natural scale, and figs. 2148. to 2150., of the natural size, from Royle and Lambert, and from Dropmore specimens.

Spec. Char., &c. Leaves in threes, very long and slender, pendulous; sheaths long. Cones ovate-oblong. Scales elevated at the apex, very thick, recurved. (*Lamb. Pin.*) Buds, in the Dropmore specimens (see fig. 2148.), from 1 in. to 1½ in. long, and nearly ½ in. broad; covered with dry scales at the lower part, and abortive leaves; swelling towards the upper part, and concavely acuminate; white, woolly, and entirely without resin. Leaves (see fig. 2150.) 1 ft. in length; sheaths ¾ in. long, white, chaffy, and lacerated. Cone (see fig. 2150.) from 5 in. to 5½ in. long, and 2½ in. to 2¾ in. broad; scale, according to Mr. Lambert's plate (see fig. 2149.), from 1½ in. to 2 in. in length. Seed, without the wing, ¼ in. long; with the wing, 1¾ in. Cotyledons, according to Lawson, about 12. Native of Nepal, and requiring protection in England.



Description, &c. A tree, growing, in Nepal, to the height of 100 ft. or upwards, with few, short, and remotely verticillate



branches. The leaves are of a vivid green, disposed in spiral rows round the young wood; and they vary in length from 9 in. to 18 in.; they are very slender, generally pendulous, and channeled so as to appear triangular in the section. They are serrated on the margins, and imperfectly scabrous throughout. Sheaths less than 1 in. in length, delicate, and lacerated at their margins. Male catkins crowded round the base of the young shoots, pointing upwards; cylindrical, and about 1 in. in length. Young cones globose, with stalks, and erect; mature cones less than one half the length of the leaves; oblong-ovate, and dark brown; outer

surface of the scales very prominent, irregularly four-sided, and recurved. Seed oval-ovate, somewhat pointed below, light-coloured, with a broad wing, also light-coloured, and nearly three times the length of the seed. *P. longifolia* is a native of Nepal, on the mountains; and also of the lower and warmer parts of India, where the tree is cultivated on account of its beautiful foliage and graceful habit of growth, but where it never attains the same magnitude as on the Himalayan Mountains. It was introduced into Britain in 1801, and for a long time was treated as a green-house plant: it is now found to stand the open air, but not without protection during winter. The largest tree in England is believed to be that at Dropmore, of which fig. 2152 is a portrait, to a scale of 1 in. to 8 ft. It was, in 1837, nearly 12 ft. high; but it is

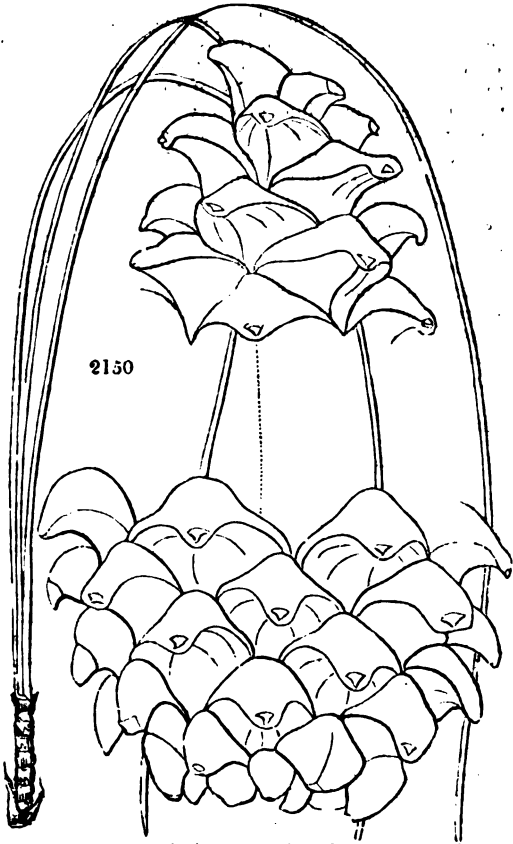

covered every winter with a portable roof of fern, enclosed in mats, and supported by a wooden frame; the sides being closed in with the same materials, but with two doors opposite each other, to open on fine days, to promote ventilation. Mr. Lawson

2152

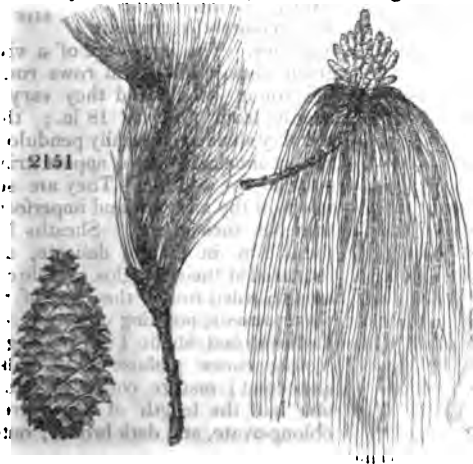

suggests that the tenderness which is apparent in some individuals of this

species may possibly arise from the seed from which they were raised having been produced by trees growing in the warm valleys of Nepal; and that, "by procuring seed from trees at the highest elevation at which they are found to exist, plants might be raised sufficiently hardy to stand the climate of Britain." (*Man., &c.*, p. 356.) Price of plants, in Lawson's Nursery, 25s. each.

§ viii. *Gerardiænae*.

Sect. Char. Leaves rather short, straight, stiff, with the sheaths caducous.

‡ 23. *P. GERARDIA'NA* Wall. Gerard's, or the short-leaved Nepal, Pine.

Identification. Lamb. Pin., ed. 2, t. 78; Lawson's Manual, p. 366; Lodd. Cat., ed. 1836.
Synonymæ. *P. Néosa* Gouan; estate-seeded Pine of the East Indies; ? *Chingdonia Elphinstoni*, no the authority of *Royle Illust.*, p. 32.
Engravings. Lamb. Pin., ed. 2, t. 78; Royle Illust., t. 85, f. 2; and our fig. 2153, from Royle, to our usual scale; and figs. 2154 and 2155, (the cone from Lambert, and the leaves from Royle, both of the natural size).

Spec. Char., &c. Leaves in threes, short; sheaths deciduous. Cones ovate-oblong; scales thick, blunt, and recurved at the apex. (*Lamb. Pin.*) Leaves, in Royle's figure, from 3½ in. to 5 in. in length; sheaths imbricate, ¾ in. in length. Cone 8 in. long, and nearly 5 in. broad. Seed ¼ in. long, and ¾ in. broad; cylindrical, pointed at both ends, and of a dark brown.

Description. A large tree, conical in form, and compact in habit; readily known from all other 3-leaved pines by the sheaths from which the leaves proceed being scaly, and falling off, like the sheaths of the division of pines having five leaves. The appearance of the leaves, with the scales, has been given by Dr. Royle, from which our fig. 2155 *b.* is copied; and the leaves may be seen without the sheaths, as they appear on the branches when full grown, in fig. 2155 *a.*, also from Royle. The cones, which bear a general resemblance to those of *P. longifolia*, are from 8 in. to 10 in. in length, and from 5 in. to 6 in. in breadth, with thick, broad, wedge-shaped scales, not woody, like those of *P. Sabiniæna*, but rather corky. The apexes are elevated, and dilated laterally, forming a semi-circular line above, and two convex segments, meeting in a blunt corky point, below, and turned downwards, as in fig. 2154. The leaves are straight, of a glaucous green, with two channels above, and convex beneath; obsolete crenulated along the centre and margins. Nothing is said respecting the timber of this tree; but the seeds are eaten by the inhabitants of the lower parts of India, in the southern countries. This species was discovered by Capt. P. Gerard, of the Bengal Native Infantry; and named in commemoration of him by Dr. Wallich. Cones have been sent to England, by Dr. Wallich and others, at different times; though they are often confounded with those of *P. longifolia*. The plant named *P. Gerardiæna* in the Horticultural Society's Garden has persistent sheaths, and long slender leaves, and is, doubtless, *P. longifolia*; and the same may be said of a number of plants at Messrs. Loddiges's. A plant at Sir Oswald Moseley's, said to be raised from seeds sent home by the Marquess of Hastings as those of *P. Gerardiæna*, is a 2-leaved pine; and evidently, from the specimen kindly sent to us by its proprietor, who is an excellent botanist, and of the same opinion, nothing more than *P. Pineæ*. A young plant at Dropmore, named there *P. Néosa*, may possibly be true. Mr. Lawson has received cones and seeds from the East Indies, and has plants of the true *P. Gerardiæna* for sale at 35s. each. There are also plants of the true *P. Gerardiæna* in the Clapton Nursery, under its synonyme of *P. Néosa*.



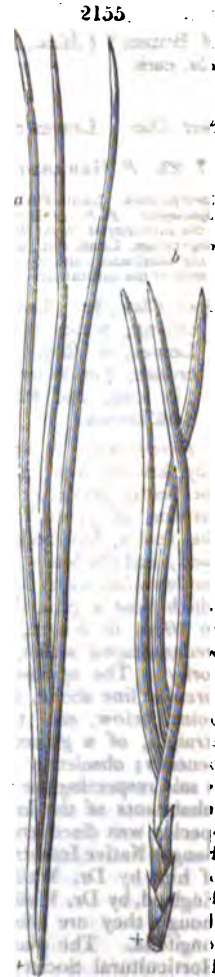
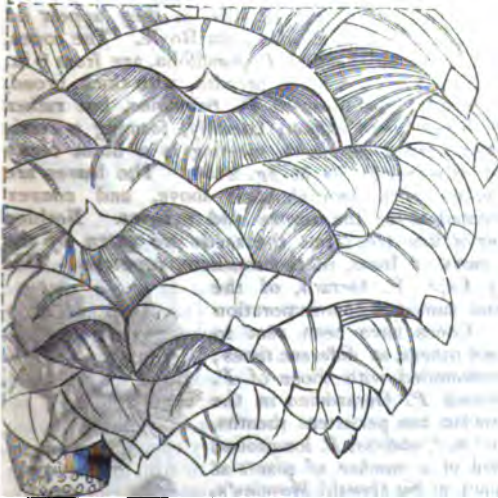

C. Cones long, slightly tubercled.

§ IX. *Australis.*

Sec. Char. Leaves and cones very long; the latter nearly as long as the leaves; scales of the cones slightly tubercled, nearly flat, with very small, caducous prickles.

‡ 24. *P. AUSTRALIS* Michx. The southern Pine.

Identification. Michx. Arb., 1. p. 62; N. Amer. Syl., 3. p. 133; N. Du Ham., 5. p. 246; Dict. des Eaux et Forêts, 2. p. 592; Lawson's Manual, p. 664

Synonymes. *P. palustris* Willd. *Sp. Pl.*, 4. p. 499. *Müll. Dict.*, 14. *At. Hort. Kew.*, 3. p. 368. *Parab. Fl. Amer. Sept.*, 2. p. 644. *Lamb. Pin.*, ed. 2., 1. t. 24, 25; *P. americana palustris*, &c. *Hort. Angl.*, p. 88. *Du Ham. Arb.*, 2. p. 126; *P. serotina* Hort., see *Bon Jard.*, ed. 1837, p. 976. In America, long-leaved Pine, yellow Pine, Pitch Pine, and Broom Pine, in the southern states; southern Pine and red Pine in the northern states; and yellow Pine and Pitch Pine in the middle states. In England and the West Indies, by the timber merchants, Georgia Pitch Pine.

Engravings. *Michx. Arb.*, 1. t. 6.; *N. Amer. Syl.*, 3. t. 141.; *Abb. Ins.*, 1. t. 42.; *Lamb. Pin.*, ed. 2., 1. t. 24, 25.; our *fig.* 2156., to our usual scale from Abbott; and *figs.* 2156, to 2158., of the natural size, from Michaux and from Dropmore specimens.

Spec. Char., &c. Leaves in threes, very long. Male catkins long, cylindrical, of a tawny blue, divergent. Cones very long, tessellated with tumid tubercles, terminated by very small mucros. (*Michx.*) Buds, in the Dropmore specimen (see *fig.* 2156.), rather small in proportion to the termination of the shoot, and buried in leaves. When the leaves are removed, the bud is found



2156

to be from $\frac{3}{8}$ to $\frac{5}{8}$ in. long, and from $\frac{1}{8}$ in. to $\frac{1}{4}$ in. broad, with numerous, far-projecting, white, fringed scales; general form conical, and wholly without resin. Leaves (see *fig.* 2158.) from 8 in. to 9 in. in length; sheath from $1\frac{1}{2}$ in. to 2 in. long, white, membranaceous, and lacerated. The cones, in Michaux's figure, 8 in.

long, and $2\frac{1}{2}$ in. broad in the widest part. Scale (*fig.* 2157.) from $1\frac{1}{2}$ in. to $1\frac{3}{4}$ in. long, and $1\frac{1}{8}$ in. broad. Seeds oval, from $\frac{3}{8}$ in. to $\frac{1}{2}$ in. in length, $\frac{1}{8}$ in. broad; whitish, with the wing $2\frac{3}{8}$ in. in length, and $\frac{1}{2}$ in. in breadth, and, as well as the cone, of a rich chestnut, brown; in Lambert's figure, the scales and seeds are much smaller. Cotyledons, ?



2157

Variety.

† *P. a. 2 excelsa*, *P. palustris excelsa* Booth, was raised in the Floetbeck Nurseries, in 1830, from seeds procured from the north-west coast of North America. The plant, in 1837, was 4 ft. high, with leaves as long as those of *P. australis*; and was quite hardy, even in that climate. Possibly a distinct species.

Description. A tree, according to Michaux, from 60 ft. to 70 ft. high, and with a trunk from 1 ft. 3 in. to 1 ft. 6 in. diameter for two thirds of its height. Some specimens, in favourable situations, attain much larger dimensions, particularly in East Florida. The bark is somewhat furrowed, and the epidermis detaches itself in thin transparent sheets. The leaves are about 1 ft. long, of a beautiful brilliant green, collected in bunches at the extremities of the branches: they are longer and more numerous on young trees. The buds are said by Michaux to be very large, white, fringed, and not resinous. The male catkins are produced in masses; they are violet-coloured, and about 2 in. long; in drying, they shed great quantities of yellowish pollen, which is diffused by the wind, and forms a momentary covering on the adjacent land and water. The cones are large, being 7 in. or 8 in. long, and 4 in. thick when open; and they are armed with very small retorted prickles. The tree flowers in April, and the cones ripen about October in the second year, and shed their seeds the same month. The kernel is of an agreeable taste, and is contained in a thin whitish shell, instead of being black, as is the case with every other species of American pine, and it is surmounted by a wing, which is often more than 2 in. in length. The seeds, in some years, are very abundant; but, in others, a forest of 100 miles in extent may be ransacked without finding a single cone; which was probably the occasion, Michaux observes, of the statement made by the French, who, in 1567, attempted to effect a settlement in Florida; viz. "that the woods were filled with superb pines, that never yielded seed." The timber is said to contain but little sap wood. Trunks 1 ft. 3 in.

in diameter, often having 10 in. of perfect wood. The concentric circles, in a trunk fully developed, are close, and at equal distances; and the resinous matter, which is abundant, is more uniformly distributed than in the other species. Hence the wood is stronger, more compact, and more durable: it is, besides, fine-grained, and susceptible of a high polish. These advantages give it a preference, as a timber tree, over every other American pine; but its quality is modified by the nature of the soil in which it grows. In the neighbourhood of the sea, where only a thin layer of mould reposes on the sand, it is more resinous than where the mould is 4 in. or 5 in. thick; and the trees which grow upon the first-mentioned soil are called pitch pines, as if they were distinct species. In certain soils, its wood contracts a reddish hue; and it is, for that reason, known in the dock-

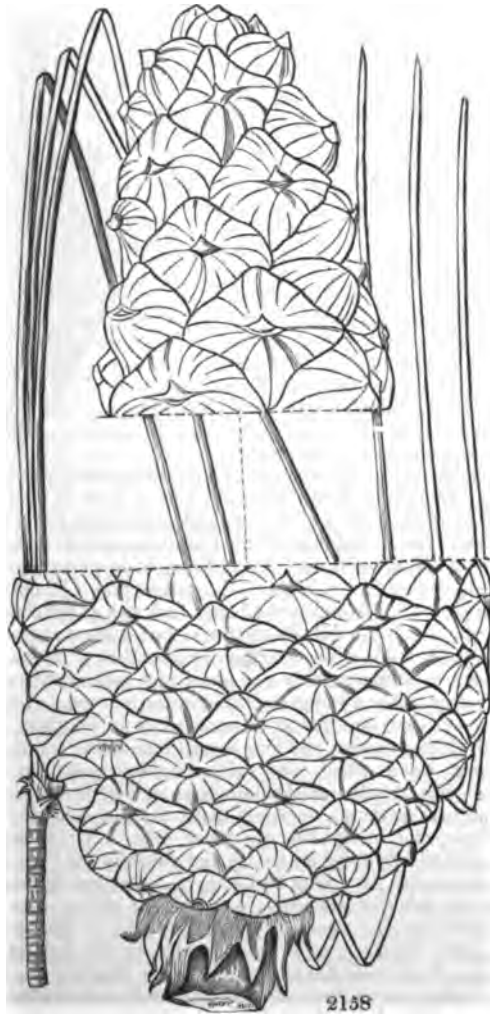

yards of the northern states by the name of the red pine. Wood of this tint is considered the best; and, in the opinion of some shipwrights, it is more durable on the sides of vessels, and less liable to injury from worms, than the oak. In the climate of London, *P. australis* is rather tender. The largest plant that we know of is at Farnham Castle, which, in 1834, after being 35 years planted, was 20 ft. high. There is one at Dropmore, of which *fig. 2160.* is a portrait, to the scale of 1 in. to 8 ft. This tree was planted where it now stands, in September, 1824, when only 4 in. high; and it is now (September, 1837) 16 ft. high, without having, during that period, received the slightest protection. M. Vilmorin states, in the *Bon Jardinier* for 1837, that, in the neighbourhood of Paris, this pine is generally grown in boxes, and taken into

the conservatories during winter. He had seen one 16 ft. high, without a single lateral branch; but, notwithstanding this, its trunk threw out numerous shoots or tufts of leaves, from adventitious or dormant buds. Some plants having stood out during the severe winter of 1829-30, M. Vilmorin is in hopes that it may be acclimatised in the neighbourhood of Paris.

Geography and History. A native of the United States, from North Carolina to Florida, abounding in extensive forests near the sea coast. "Towards the north, the long-leaved pine first makes its appearance near Norfolk in Virginia, where the pine barrens begin. It seems to be especially assigned to dry sandy soils; and it is found, almost without interruption, in the lower part of the Carolinas, Georgia, and the Floridas, over a tract of more than 600 miles long from north-east to south-west, and more than 100 miles broad from the sea towards the mountains of the Carolinas and Georgia. Where it begins to show itself towards the river Nuse, it is united with the loblolly pine (*Pinus Tæda*), the yellow pine (*P. mitis*), the pond pine (*P. serótina*), the black Jack oak (*Quercus nigra*), and the scrub oak (*Q. Bannisteri*): but, immediately beyond Raleigh, it holds almost exclusive possession of the soil, and is seen in company with the pines just mentioned, only on the edges of the swamps enclosed in the barrens; even there, not more than one tree in a hundred is of another species. With this exception, the long-leaved pine forms the unbroken mass of woods which covers this extensive country; but, between Fayetteville and Wilmington, in North Carolina, the scrub oak is found, in some districts, mixed with it in the barrens; and, except this species of pine, it is the only tree capable of subsisting on so dry and sterile a soil." (*Michx.*) Wangenheim, according to Lambert, says that dry land does not suit this pine, but only low marshy spots; whence Solander's specific name of *palústris*; which, Michaux very properly observes, gives a false idea of the habitat of the plant. *P. australis* has been cultivated in England since 1730; but being (as we have already observed) rather tender, though it will stand the climate of London in the open air without protection, it is not common in collections. M. Michaux recommends it for the south of France, and particularly for the neighbourhood of Bordeaux, in soils and situations where the pinaster flourishes.

Properties and Uses. The timber of the long-leaved pine is applied to a great variety of purposes in the Carolinas, Georgia, and the Floridas. Four fifths of the houses are built of it, except the roof, which is covered with shingles of cypress; though sometimes the shingles also are made of pine, in which case they require to be renewed after 15 or 18 years, owing to the warmth and humidity of the climate. It is generally used for the enclosure of cultivated fields; and, in the southern states, it is preferred before all other pines in naval architecture. No other species is exported from the southern states to the West Indies; and it is also sent in large quantities to Liver-

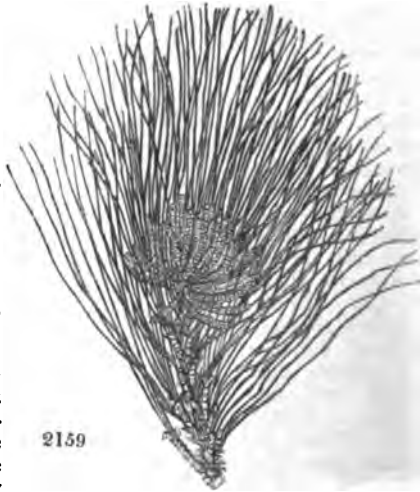

pool; where, according to Michaux, it is called the Georgia pitch pine, and is sold at 25 per cent or 30 per cent higher than any other pine imported from the United States. The young trees, which have larger and more numerous leaves than the old ones, are sometimes cut by the negroes for brooms; and hence the name of broom pine. *P. australis* supplies nearly all the resinous matter used in the United States in ship-building. Formerly, tar was made in all the lower parts of the Carolinas and Georgia; but at present this manufacture is confined to the lower districts of North Carolina. The resinous products of this pine are, turpentine, scrapings, spirit of turpentine, resin, tar, and pitch. Of these, turpentine is the raw sap of the tree obtained by making incisions in the trunk. It begins to distil about the middle of March, when the circulation commences, and it flows with increasing abundance as the weather becomes warmer; so that July and August are the most productive months. The sap is collected in what are in America termed boxes: these are incisions, notches, or cavities, cut in the tree, about 3 in. or 4 in. from the ground, generally of a sufficient size to hold about three pints of sap, but proportioned to the size of the tree; the rule being that the cavity shall not exceed one fourth of the diameter of the tree. These cavities are made in January or February, commencing with the south side, which is thought the best, and going round the tree. The next operation is the raking or clearing the ground from leaves and herbage. About the middle of March, a notch is made in the tree, with two oblique gutters, to conduct the sap that flows from the wood into the box, or cavity, below. In about a fortnight, the box becomes full, and a wooden shovel is used to transfer its contents to a pail, by means of which it is conveyed to a large cask placed at a convenient distance. The edges of the wound are chipped every week, and the boxes, after the first, generally fill in about three weeks. The sap thus procured is used as turpentine, without any preparation, and is called pure dripping. The scrapings are the crusts of resin that are formed on the sides of the wounds; and these are often mixed with the turpentine, which, in this state, is used in the manufacture of yellow soap, and is called Boston turpentine. Long-continued rains check the flow of the sap, and even cause the wounds to close; and, for this reason, very little turpentine is procured in cold damp seasons. In five or six years, the tree is abandoned; and the bark never becomes sufficiently healed to allow of the same place being wounded twice.

Spirits of turpentine are made principally in North Carolina; and are obtained by distilling the turpentine in large copper retorts. Six barrels of turpentine are said to afford one cask, or 122 quarts, of the spirit. The residuum, after the distillation, is resin, which is sold at one third of the price of the turpentine.

All the tar of the southern states is made from the dead wood of *P. australis*, consisting of trees prostrated by time, or by the fires annually kindled in the forests; of the summits of those that are felled for timber; and of limbs broken off by the ice that sometimes overloads the trees. (See p. 2137.) It has been already observed (p. 2108.), that, as soon as vegetation ceases in any part of a pine tree, its consistence changes: the sap wood decays, and the heart wood becomes surcharged with resinous juice, to such a degree as to double its weight in a year; and that this accumulation increases for several years. Dead wood is thus productive of tar for several years after it has fallen from the tree.

To procure the tar, a kiln is formed in a part of the forest abounding in dead wood: this is first collected, stripped of the sap wood, and cut into billets 2 ft. or 3 ft. long, and about 3 in. thick; a task which is rendered tedious and difficult by the numerous knots with which the wood abounds. The next step is to prepare a place for piling the billets; and for this purpose a circular mound is raised, slightly declining from the circumference to the centre, and surrounded by a shallow ditch. The diameter of the pile is proportioned to the quantity of wood which it is to receive: to obtain 100 barrels of tar, it should be 18 ft. or 20 ft. wide. In the middle is a hole, with a conduit

leading to the ditch; in which is formed a receptacle for the tar as it flows out. Upon the surface of the mound, after it has been beaten hard, and coated with clay, the wood is laid round in a circle, like rays. The pile, when finished, may be compared to a cone truncated at two thirds of its height, and reversed; being 20 ft. in diameter below, 25 ft. or 30 ft. above, and 10 ft. or 12 ft. high. It is then strewed over with pine leaves, covered with earth, and held together at the sides with a slight cincture of wood. This covering is necessary, in order that the fire kindled at the top may penetrate downwards towards the bottom, with a slow and gradual combustion; for, if the whole mass were rapidly inflamed, the operation would fail, and the tar would be consumed instead of being distilled: in fine, the same precautions are exacted in this process as are observed in Europe in making charcoal. A kiln, which is to afford 100 or 130 barrels of tar, is eight or nine days in burning. As the tar flows off into the ditch, it is emptied into casks containing 30 gallons each, which are always made of pine wood. Pitch is tar reduced by evaporation: it should not be diminished more than half its bulk to be of good quality. (*Michx.*)

Accidents, Diseases, &c. Forests of the long-leaved pine are particularly liable to be consumed by fire, on account of the abundance of resin which the trees contain, and the great length of their leaves, which easily take fire, and spread it rapidly. Immense swarms of small insects, Michaux observes, insinuate themselves under the bark of this pine, penetrate into the body of the tree, and cause it to perish in the course of a year. This has been noticed also by Dwight, in his *Travels in New England*; and it appears that this insect is not peculiar to the long-leaved pine, for extensive tracts, according both to Michaux and Dwight, are seen, both in the northern and southern states, covered solely with dead pines. In Abbott and Smith's *Insects of Georgia*, i. t. 42., is the figure of a moth which attacks this pine (*Sphinx coniferarum*), of which our *fig.* 2161. is a copy. "The larva was taken feeding on

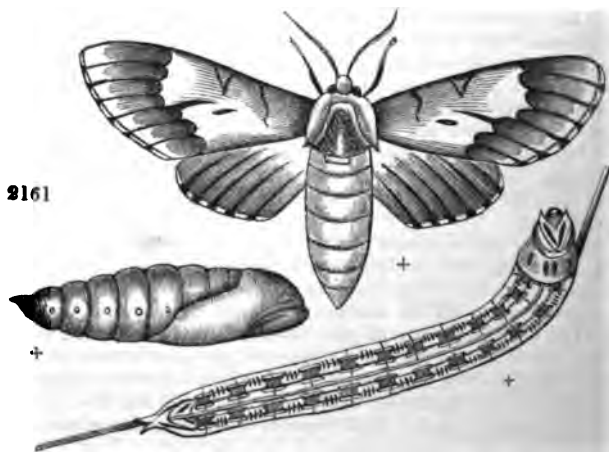

the long-leaved pine in August, on the 27th of which month it went into the ground. Another buried itself so late as the 10th of November. The moth was produced on April 8. It is not very common; but may be found occasionally, throughout the summer, in Georgia, sitting on the trunks of pines. It feeds also on the cypress, and is found in Virginia. This species is distinct from the European *S. Pináster*." (*Sm. and Abb.*)

Statistics. In the neighbourhood of London, at Muswell Hill, 10 years planted, it is 8 ft. high. In Devonshire, at Luscombe, 10 years planted, it is 14 ft. high. In Surrey, at Farnham Castle, 35 years planted, it is 20 ft. high; at Oakham Park, 9 years planted, it is 5 ft. high. In Cheshire, at

Eaton Hall, 6 years planted, it is 6 ft. 6 in. high. In France, at Nantes, in the nursery of M. Nerrières, 10 years planted, it is 18 ft. high.

Commercial Statistics. Plants, in the London nurseries, are 5s. each; and at Bollwyller, 5 francs.

§ x. *Canarienses.*

Sect. Char. Leaves long, slender. Cones shorter than the leaves, more or less tubercled; the tubercles terminating in blunt points, without spines or hooks.

‡ 25. *P. CANARIENSIS* C. Smith. The Canary Pine.

Identification. C. Smith in Buch Fl. Can., p. 32. and 34.; Dec. Pl. Rar. Jard. Gen., 1. p. 1.; Lamb. Pin., ed. 2., 1. t. 28.; Lawson's Manual, p. 357.; Bon Jard., 1837, p. 976.

Synonymæ. † *P. addūca* Bosc, according to Sprengel.

Engravings. Dec. Pl. Rar. Jard. Gen., 1. t. 1, 2.; Lamb. Pin., ed. 2., 1. t. 28.; our *fig.* 2165., to our usual scale; and *Figs.* 2162. to 2164., of the natural size.

Spec. Char., &c. Leaves in threes, very long and spreading, rough. Crest of the anthers round, entire. Cones oblong, tuberculate. (*Lamb. Pin.*) Buds, in the Dropmore specimen (see *fig.* 2162.), from $\frac{3}{8}$ in. to $\frac{1}{2}$ in. long, and from $\frac{1}{8}$ in. to $\frac{1}{4}$ in. broad; dry and scaly, white, and without resin. Leaves (see *fig.* 2164.) from 7 in. to 7½ in. long, and slender; sheaths from $\frac{1}{2}$ in. to $\frac{3}{4}$ in. long, whitish, membranous, torn at the margin, and brownish at the base. Cone, in Lambert's figure, 5½ in. long, and 2½ in. broad; scale 2 in. long and 1½ in. broad, terminating in an irregular pyramidal process, at the apex of which is a blunt point, like that of *P. Pinaster*. Scales (see *fig.* 2163.) 2 in. long, and 1½ in. broad. Seeds $\frac{1}{2}$ in. long, and $\frac{1}{4}$ in. broad; flat, pointed at both extremities, with the wing $1\frac{1}{8}$ in. long, and $\frac{1}{8}$ in. broad at the widest part: colour a whitish brown. Cotyledons,? The tree throws out abundance of shoots and tufts of leaves from the dormant buds in the trunk and larger branches; more especially at places where any branches have been cut off.



Description. A tree, from 60 ft. to 70 ft. high. Branchlets squarrose, with stipular, crowded, lanceolate, acuminate, threadlike, and ciliated, revolute scales; callous and rigid at the base. Leaves in threes, recurved and spreading, generally pendulous, very long, slender, wavy, a little tortuous, compressed; callous and mucronate at the apex, bicanaliculate above, serrulated on the margins and on the intermediate elevated angle, scabrous, convex beneath, very smooth, shining, marked with dotted parallel lines; grass green; 7 in. to 1 ft. in length; sheaths cylindrical, loose at the apex, torn, $\frac{1}{2}$ in. long. Male catkins many, clustered, verticillate, cylindrical, obtuse, 1 in. long. Crest of the anthers roundish, membranaceous, entire. Cones ovate-oblong, tubercled, 4 in. to 6 in. long, 2 in. in diameter at the base; scales thick, woody, dilated at the apex, depressed-quadrangular, truncate. Seeds oblong, dark brown; wing membranaceous, striated, obliquely truncated, brownish. (*Lamb.*) This species, *P. longifolia*, and *P. leiophylla* bear a close general resemblance, and are all rather tender; but, when the leaves and buds are examined closely, their specific difference becomes obvious. Lambert states that this species differs from *P. longifolia* chiefly in the much more depressed and straight-pointed tubercles of its cones; those of *P. longifolia* being hooked. The largest specimen of this pine that we know of is at Dropmore, of which *fig.* 2166. is a portrait, and where, after having been 14 years planted, it was, in 1837, 17 ft. high. It is protected during winter in the same manner as *P. longifolia*, and *P. leiophylla*. "A plant in the Trinity College Botanic Garden, Dublin, raised there about 1815, from seeds collected by the late Dr. Smith of

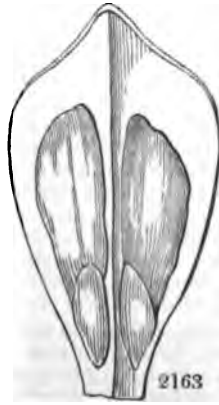

2164

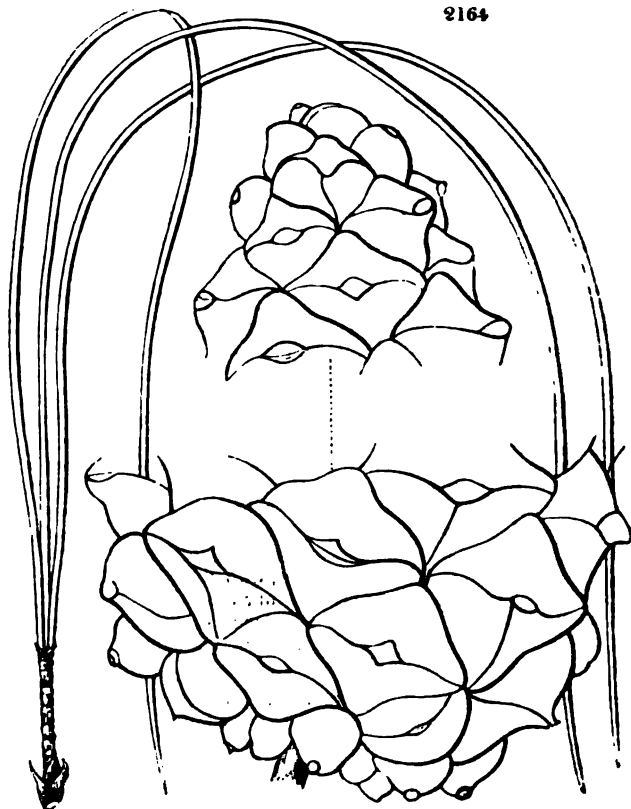

Christiana, at Teneriffe, attained the height of 15 ft. without any protection, and remained uninjured till the severe spring of 1830, when the top was completely destroyed. In the early part of the summer of that year, however, the trunk threw out two or three shoots, a few inches above the collar, and, the dead part above it being cut off, these shoots have grown vigorously ever since; and one of them, having taken the lead, promises to make a handsome plant. A tree of the same age in Dr. Percival's garden at Annfield, near Dublin, met with a similar fate at the same time; but has now become as handsome a plant as it was before the accident. — *J. T. M. August, 1837.*"

Geography, History, &c. *P. canariensis* is a native of the islands of Teneriffe and Grand Canary; where it forms extensive forests, from the sea shore to an altitude on the mountains of 6700 ft.; though it is most abundant between 4080 ft. and 5900 ft. above the level of the sea, which may be considered as the pine region of these islands. This pine has been long noticed by travellers who visited Teneriffe; but it was confounded with *P. maritima*, *P. Tæ'da*, and even *Larix europæ'a*, till the name of the species was settled by Professor Smith of Christiana. In its general appearance, Messrs. Webb and Berthollet observe, *P. canariensis* resembles the European species; and the first view of a pine forest in the Canaries is very similar to that of a pine forest on the Alps. Under these gigantic trees, the soil is dry and poor; and very few plants grow beneath their shade. The pines grow on the margins of the valleys, and on the steep slopes and rugged precipices which form the sides of the mountains, but not on their summits. (*Hist. Nat. de*

Iles Canaries, Geog. Bot., p. 21.) The forests of pines, in Grand Canary Island, extend from Oratava, near Doma jito, 3198 ft. above the level of the sea, to Portillo de la Villa, at an altitude of nearly 6000 ft. The volcanic nature of the soil, the broken rocks, evidently torn asunder by some tremendous convulsion of nature, the terrific precipices, the yawning chasms, and immense masses of lava, which are found in different directions through this region, convey a most appalling image of desolation; and trees of *P. canariensis*, which appear in some cases merely spreading their roots over the loose rocks, are the only signs of life or vegetation that can be perceived.

The island is exposed to fearful storms, particularly one from the south-east, called there the wind of Africa, which tears up the pines by the roots. In the *Voyage aux Iles Canaries*, by Father Feuillée, made in 1724, it is stated that the mountain was then entirely covered with pines; and one tree is particularly mentioned, which was called the Pino de la Caravela. This pine, which had been previously seen and described by J. Edens (*Phil. Trans. Soc. Roy. Lond.*, 1714-16), received its name from the extension of its branches, which, at a distance, gave it the appearance of a ship. The same traveller mentions another remarkable tree, Pino de la Merienda, which is still standing, though most of the other pine trees described by these travellers have disappeared. "The Pino de la Caravela no longer exists, but it has bequeathed its name to the rock which served as its base. The Pin du Domajito has shared the same fate: the storm of 1826 having torn it up by the roots. The trunk of this tree, which was covered with a species of *U'snea*, had acquired an enormous thickness, and was seen from every part of the valley. Viera, in his *Noticias*, mentions another enormous pine which grew in the Canaries, in the district of Teror, at an altitude of about 1600 ft. The trunk of this tree was nearly 30 ft. French (32 ft. 6 in. English) in circumference at the base; closely united to it was the chapel of Neustra Señora del Pino, and one of its arms served as a buttress to support the belfry; but repeated earthquakes in time destroyed this singular chapel and, on April the 3d, 1684, the *pino santo* fell, and crushed the chapel, of which it had so long formed part. Viera adds that the reason of the chapel being placed so near this tree was, that, in 1483, an extraordinary light was perceived to hover round, or rather issue from, the pine. Don Juan de Frios, who was both a bishop and a warrior, alone ventured to ascend the tree, and there found, reposing in a sort of cradle formed by the interlacement of the branches, and lined with the softest and purest moss, an image of the Holy Virgin, in honour of whom the chapel was afterwards built. The fruit of this holy tree is said to have been useful

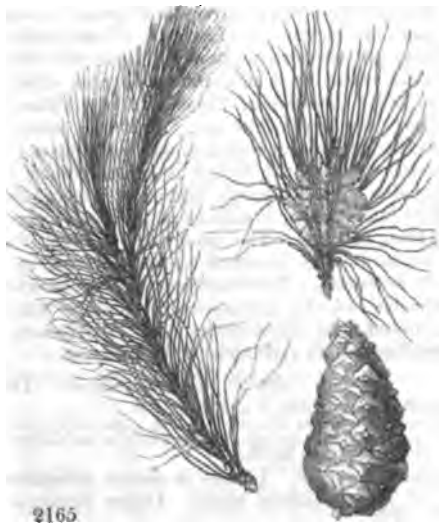

in medicine; and a miraculous spring is supposed to have flowed from its root, which cured all diseases, till an avaricious priest put it under lock and key, not allowing any one to taste the water, unless they first gave ample alms, when, as a punishment for his cupidity, the stream dried up. (*Ibid.*, p. 152.) The Isle of Palma has also a *pino santo* which grows about 2727 ft. above the level of the sea. This tree, which is said to have been in existence at the time of the conquest of the Canaries (1483), shows no signs of age. A small statue of the Virgin is placed among its branches, beside which is suspended a kind of lamp; and every evening the woodcutters of the forest light this lamp, which is seen to a great distance glimmering through the trees. (*Ibid.*, p. 154.) The timber of *P. canariensis* is said to be very resinous, not liable to be attacked by insects, and, in favourable situations, to endure for centuries. The inhabitants of the Canaries use the wood for torches. The species may be propagated by making cuttings of the young shoots which proceed from the dormant buds (see *Description* above, and p. 2128.), or by grafting on *P. sylvéstris* or *P. Pináster*.

‡ 26. *P. SINE'NSIS* Lamb. The Chinese Pine.

Identification. Lamb. Pin., ed. 2. l. t. 29.

Engravings. Lamb. Pin., ed. 2., l. t. 29.; and our *fig.* 2168., to our usual scale, from a specimen of a tree at Redleaf; and *figs.* 2169. and 2170., of the natural size, the cone and leaves from Lambert, and the bud from Redleaf.

Spec. Char., &c. Leaves in threes, sometimes in twos, very slender. Male catkins short. Cones ovate; scales truncate at the apex, without any point. (*Lamb.*, and *obs.*) A large tree. Branches tubercled. Leaves squarrose, with stipular scales; twin, or in threes, slender, spreading, semicylindrical, mucronated, serrulated; grass green, 5 in. long: sheaths cylindrical, $\frac{1}{2}$ in. long. Male catkins numerous, somewhat verticillate, $\frac{3}{4}$ in. long. Cones with very short footstalks, ovate, brownish, 2 in. long; scales thick, woody, tetragonal at the apex, flattened, truncate, mutic. (*Lamb.*) Buds, in the Redleaf specimen (see *fig.* 2167.), from $\frac{1}{8}$ in. to $\frac{1}{4}$ in. in length, and about the same breadth; bluntly pointed, with numerous fine scales, of a brownish colour, and wholly without resin. Leaves from 5 in. to 5 $\frac{1}{2}$ in. in length; three-sided, slender, straight, and about the same colour as those of *P. Pinea*; sheaths from $\frac{3}{8}$ in. to $\frac{1}{2}$ in.



2167



2168

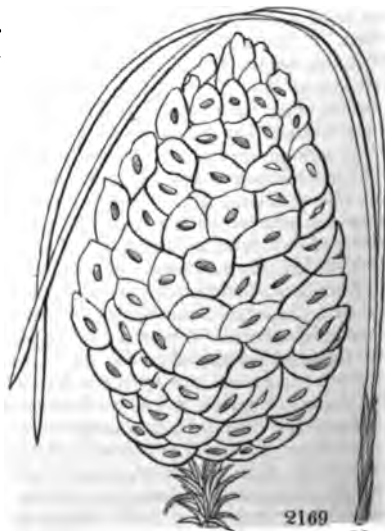

2169

long; brownish, slightly membranaceous, and rigid. A native of China. There is a tree at Redleaf, raised by William Wells, Esq., from seeds

received from China in 1829, which is now 16 ft. high, tolerably hardy, and a very handsome plant. Mr. Lambert's figure is taken from a Chinese drawing in the possession of the Horticultural Society, which may be the reason why in his specific character he has described the leaves as two in a sheath: in Mr. Wells's plant, the number in a sheath is for the most part three.

‡ 27. *P. INSIGNIS* Doug. The remarkable Pine.

Identification. Douglas's specimens in the Horticultural Society's herbarium. *Engravings.* Our *fig.* 2172, to our usual scale, and *fig.* 2171, of the natural size, both from Douglas's specimens in the Horticultural Society's herbarium; and *fig.* 2170, from the side shoot of a young tree in the Horticultural Society's Garden.

Spec. Char., &c. Leaves three, and occasionally four, in a sheath; much twisted, varying greatly in length, longer than the cones, of a deep grass green, and very numerous. Cones ovate, pointed, with the scales tuberculate. Buds (see *fig.* 2170.), of the side shoots of young plants, from $\frac{1}{4}$ in. to $\frac{1}{2}$ in. long, and from $\frac{1}{4}$ in. to $\frac{1}{2}$ in. broad, brown, and apparently without resin; on the leading shoots a

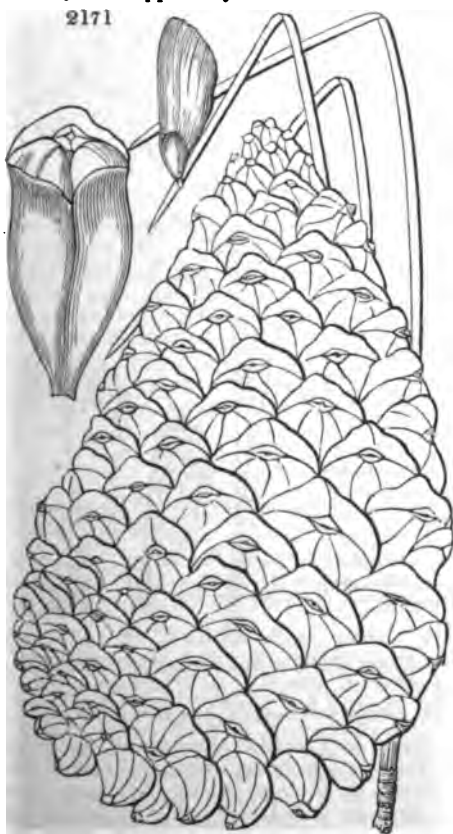

great deal larger, and resembling in form, and almost in size, those of *P. Sabina*. Leaves, in Douglas's specimen, from 3 in. to 4½ in. long; on the plant in the



Horticultural Society's Garden, from 5 in. to 7 in. long. This pine is well named *insignis*; its general appearance being indeed remarkable, and totally different

from that of every other species that has yet been introduced. The leaves are of a deep grass green, thickly set on the branches, twisted in every direction, and of different lengths. The plant seems of vigorous growth, and as hardy as any of the Californian pines. It was sent home by Douglas in 1833; and the plants in the Horticultural Society's Garden,

and in the Duke of Devonshire's villa at Chiswick, are from 3 ft. to 5 ft. in height. It is needless to say that such a pine ought to be in every collection. Plants, in the London nurseries, are 5*l.* each.

‡ 28. *P. TEOCO' TE* Schiede et Deppe. The Teocote, or twisted-leaved, Pine.

Identification. Schiede et Deppe in Schlecht. *Linnaea*, 5. p. 76.; *Lamb. Pin.*, ed. 2, 1. t. 90.

Engravings. *Lamb. Pin.*, ed. 2, 1. t. 20., from specimens furnished by MM. Schiede and Deppe, the discoverers; and our *Figs.* 2173. and 2174., from Lambert's figures, and from a specimen of a living plant at Boyton.

Spec. Char., &c. Leaves in threes, compressed, flexuose, scabrous; sheaths about $\frac{1}{2}$ in. long. Cones ovate, smoothish. (*Lamb. Pin.*) A native of Mount Orizaba, near Vera Cruz, in Mexico. Introduced by A. B. Lambert, Esq., in 1826, or before.

Description. Branchlets very leafy, with a persistent epidermis. Buds imbricated with lanceolate, acuminate, ciliate, and torn scales. Leaves

in threes, erect, rigid, compressed, acute, tortuous; light green, bicanalicate above, slightly convex beneath, very smooth; the intermediate slightly prominent angle, and the margins, crenulated, scabrous; sheaths cylindrical, about

1 in. in length, persistent, torn on the margin. Cones ovate-oblong, drooping, smoothish, scarcely 3 in. long; scales dilated at the apex, somewhat trapezoidal, much depressed; in the young cones always mutic. (*Lamb.*) This is a very rare species; there being no plants of it either at Dropmore or in the Horticultural Society's Garden. Indeed, so far as we are aware, it exists in no other collection in Britain, than that of Mr. Lambert at Boyton.

‡ 29. *P. PA'TULA* Schiede et Deppe MSS. The spreading-leaved Pine.

Identification. *Lamb. Pin.*, ed. 1, t. 19.

Engravings. *Lamb. Pin.*, ed. 2, 1. t. 19.; and *Figs.* 2175. and 2176., from Mr. Lambert's figure.

Spec. Char., &c. Leaves in threes, very slender, 2-channelled, spreading; sheaths about 1 in. long. Cones ovate-oblong, polished. (*Lamb. Pin.*)

A native of Mexico, at Malpayo de la Joya, in the cold region, where it was discovered by MM. Schiede and Deppe, and introduced into England by Mr. Lambert.

Description. Branchlets covered with a smooth, ash-lead-coloured, and persistent epidermis. Scales of the bud lanceolate, acuminate, carinate, rigid, thread-like, and ciliate. Leaves in threes, slender, recurved and spreading; soft, light green; deeply bicanalicate above, convex beneath.

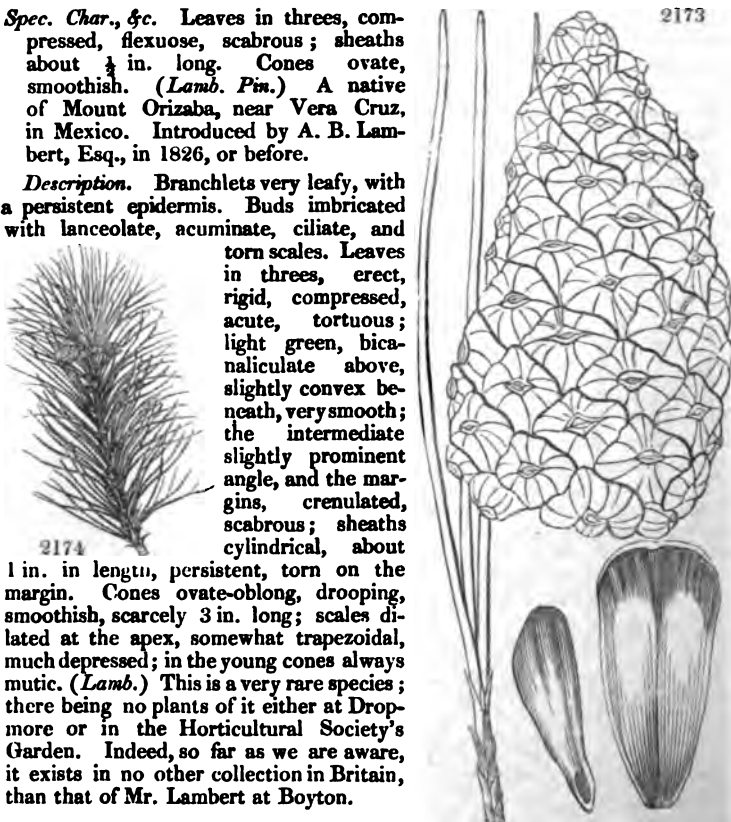

marked with many dotted lines; 6 in. to 9 in. long; the intermediate somewhat prominent angle, and the margins, sharply serrated, scabrous; sheaths cylindrical, 1 in. to 1½ in. long; apex and margin of the scales thread-like and ciliated. Cones ovate-oblong, smooth, about 4 in. long; scales dilated at the apex, much depressed, flattish, somewhat trapezoidal; in the



young cone, mucronulate. (Lamb.) Mr. Lambert states that he has figured this species from specimens received from MM. Schiede and Deppe, and that he could add nothing more than that it is abundantly different from every other species of the genus. He has a plant at Boyton, which, in 1837, was 6 ft. high.

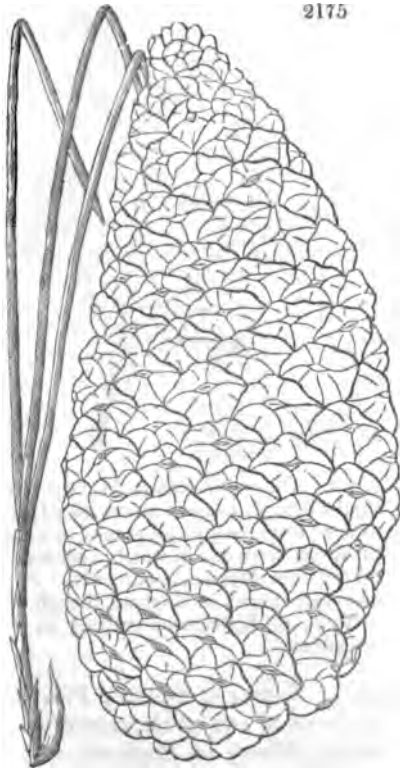

§ xi. *Llaveana*.

Sect. Char. Sheaths of the leaves caducous. Cones slightly tubercled, without prickles.

‡ 30. *P. LLAVEANA* Otto. La Llave's Pine.

Identification. The name affixed to the plant sent by M. Otto to the Horticultural Society.
Engravings. Our figs. 2180. and 2181., from specimens of the tree in the London Horticultural Society's Garden.

Spec. Char., &c. Leaves short, narrow, triquetrous, slightly twisted, in thickly set tufts on the branches, of a glaucous green. Branches in regular whorls, smooth, of an ash grey, declining towards the stem. Buds exceedingly small, in form, and in every other respect, like those of *P. halepensis*; the buds are scarcely ¼ in. long, and from ¼ in. to ½ in. broad; roundish, with two or three smaller buds. (See fig. 2177.) Leaves generally in threes, often in twos, and sometimes in fours, varying from 1½ in. to 2½ in. in length; flat on the upper surface, and cylindrical, with a rib below; sheaths short, and caducous. Cones conical, pointed, 2½ in. long, and 1½ in. broad (see fig. 2179); scale ¾ in. long, and ¾ in. broad; slightly tubercled, and without prickles. Seed, ? A very handsome species, a native of 2177 Mexico. The plant in the Horticultural Society's Garden was received from M. Otto of Berlin, about 1830; and, in 1837, was about 4 ft. 6 in. high. It seems quite hardy, and likely to form one of the most elegant species of the

Description. A straight middle-sized tree, about 40 ft. high. Cones in clusters (2 or 3), unequally-sided, ovate, about 3 in. long; scales wedge-shaped, very thick; dilated at the apex, obsoletely 4-angled, mucronated with an elevated umbilicus; elongated at the external base, compressed on both sides, callous, rigid, smooth, shining, recurved, and spreading. (*D. Don.*) A native of California, at San Luis, where it is called Obispo (the bishop), growing at the height of 3000 ft. above the level of the sea. Professor Don informs us that the cones grow 2 or 3 together; and adds, that he had not seen the leaves of this, or of *P. tuberculata* and *P. radiata*, but that he thinks it is probable that, like the greater part of the American pines, they grow in threes." (*Lin. Trans. and Lamb. Pin.*)

‡ 33. *P. TUBERCULATA* *D. Don.* The tuberculated Pine.

Identification. *Lin. Trans.*, 17. p. 442.; *Lamb. Pin.*, 3. *Engravings.* *Lamb. Pin.*, 3. t. 85.; and our *fig.* 2181.

Spec. Char., &c. ? Leaves in threes. Cones oblong, with unequal sides, crowded. Scales quadrangular, and truncate at the apex, with a depressed umbilicus; those at the exterior base larger, elevated, and conical. (*D. Don.*) Cones, in Lambert's figure, $4\frac{1}{2}$ in. long, and 2 in. broad. A native of California, at Monte-Rey, on the sea shore.

Description. A tree about 100 ft. high. Cones oblong, 3 in a cluster, of a tawny grey, 4 in. long, $2\frac{1}{2}$ in. broad; scales wedge-shaped, dilated at the apex, quadrangular, truncate, with a depressed umbilicus; larger at the external base, conical with an elevated apex. (*D. Don.*) Found by Dr. Coulter, along with *P. radiata*, which it resembles in size and habit, but is essentially distinguished by the form of its cones. (*Don in Linn. Trans. and Lamb. Pin.*)



2181



‡ 34. *P. RADIATA* *D. Don.* The radiated-scaled Pine.

Identification. *Lin. Trans.*, 17. p. 442.; *Lamb. Pin.*, 3. *Engravings.* *Lamb. Pin.*, 3. t. 85.; and our *fig.* 2182.

Spec. Char., &c. ? Leaves in threes. Cones ovate, with unequal sides. Scales radiately cleft, truncate, with a depressed umbilicus; somewhat recurved, and three times as large at their external base. (*D. Don.*) Cones, in Lambert's figure, $5\frac{1}{2}$ in. long, and $3\frac{1}{2}$ in. broad.

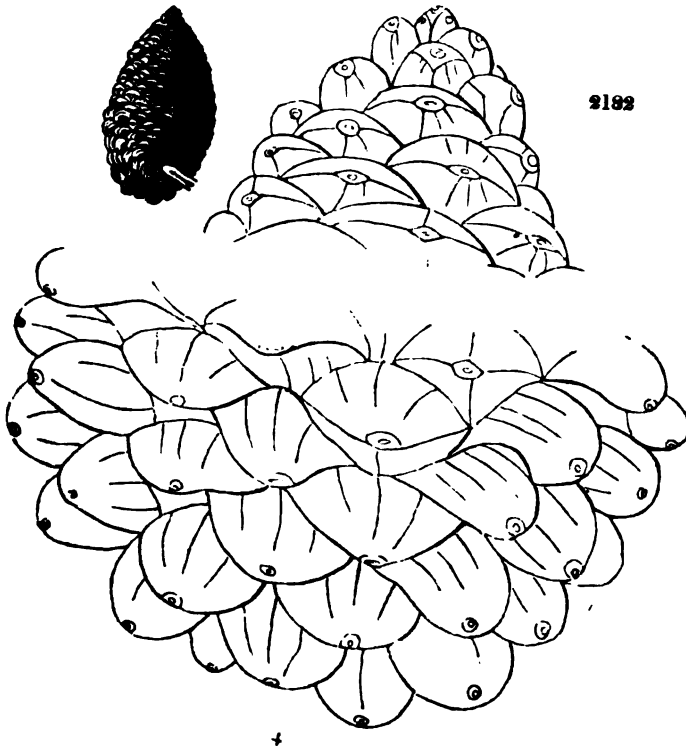

Description, &c. An erect tree, attaining the height of about 100 ft., with copious spreading branches, reaching almost to the ground. Cones in clusters, ovate, about 6 in. long, ventricose at the external base; scales wedge-shaped, thick, bright brown, shining, dilated at the apex, depressed, quadrangular, radiately-cleft; umbilicus depressed; three times larger at the external base; apex elevated, gibbous, somewhat recurved. "Found by Dr. Coulter about Monte-Rey, in lat. 36°, near the level of the sea, and growing almost close to the beech. The trees grow singly, and reach the height of 100 ft., with a straight trunk, feathered with branches almost to the ground. This species affords excellent timber, which is very tough, and admirably adapted for building boats, for which purpose it is much used."

Sect. iii. *Quinæ*. — *Leaves 5 in a Sheath.*

§ xii. *Occidentales.*

Sect. Char. Leaves long; sheaths persistent. Cones tubercled.

† 35. *P. OCCIDENTALIS* Swartz. The West-Indian Pine.

Identification. Swartz Prod., 103; Fl. Ind. Occid., 2. 1830; N. Du Ham., 5. p. 260; Lamb. Pin., ed. 2., 1. t. 23; Mart. Mill., No. 10; Bon Jard., 1837, p. 977.
Synonymes. *P. foliis quinæ*, &c., Plum. Cat., 17.; *Plant. Amer.*, 154.; *Willd. Sp. Pl.*, 4. p. 501.; *Poir. Dict. Encyc.*, 5. p. 342.; *Larix americana* Tournef. Inst., 586.
Engravings. Lamb. Pin., ed. 2., 1. t. 23.; N. Du Ham., 5. t. 72. f. 2.; Plum. Plant. Amer., t. 161.; and our fig. 2182., from the Nouveau Du Hamel.

Spec. Char., &c. Leaves in fives, slender; sheaths persistent. Cones conical, half the length of the leaves; scales thickened at the apex, with very small mucron. (*100*). The following character of this pine is given by M. Lousleur Deslogramps in the *Nouveau Du Hamel*, from a specimen with perfect cones, preserved in the herbarium of M. Poiteau, who gathered it himself in its native country. The leaves of this pine are very slender, from 6 in. to 8 in. long, in fives; sheath about $\frac{1}{2}$ in. long, not caducous, as in *P. Ströbus* and *P. Cembra*. At the base of the leaves is a lanceolate scale, a few lines long. The cones are about 3 in. long; the scales are swelled at their upper extremity, and angular; having an umbilicus on the summit, terminated by a small, straight, very slender point. This pine is a native of the mountains of St. Domingo. There is reason to believe that it may be acclimatised in the south of France, as snow occasionally falls on the mountains where it is indigenous. In the *Bos Jardnier*, M. Poiteau observes that he met with this pine in abundance in St. Domingo, in the quarter of Saint Suzanne, where it grows to the height of from 25 ft. to 30 ft., with leaves 6 in. long, of a fine green, and cones somewhat larger than those of *P. sylvestris*.

† 36. *P. MONTEZUMÆ* Lamb. Montezuma's, or the rough-branched Mexican, Pine.

Identification. Lamb. Pin., 1. t. 22.
Synonymy. *P. occidentalis* Kunth in Humb. et Bonp. *Nov. Gen. et Sp. Pl.*, 2 p. 4., Deppé in Schlecht. *Linnæa*, 5 p. 76.
Engravings. Lamb. Pin., ed. 2., 1. t. 22; and our figs. 2184. and 2185., from Lambert.

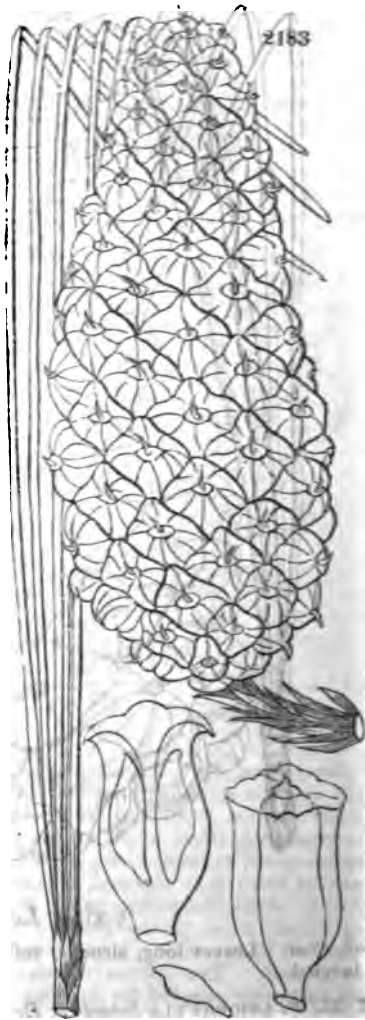
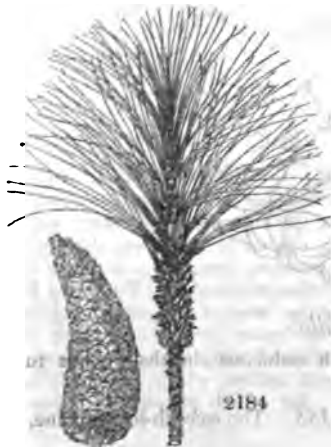

Spec. Char., &c. Leaves in fives, erect, triquetrous; sheaths about 1 in. long, persistent. Cones oblong, about 9 in. long, tuberculate. (*Lamb. Pin.*) A native of Orizaba, and other mountains of Mexico.

Description. A tall tree. Branchlets covered with a thick scabrous bark. Leaves generally in fives, rarely in threes or fours, stipular, persistent, lanceolate, much pointed, with ciliated and torn apices, serrate, somewhat rigid, triquetrous, callose and mucronate, glaucous green, marked with many parallel dotted lines; slightly bicannaliculate above, flattish beneath, 6 in. long; angles annulate, scabrous; sheaths 1 in. to $1\frac{1}{2}$ in. long, persistent; scales amentaceous, ciliate and torn on the margin, bright brown. Male catkins cylindrical, 1 in. long, with many imbricated, oval, ciliated scales at the base. Appendage to the anthers roundish, convex, coriaceous, membranaceous on the margin, torn, and crenulated. Cones oblong, tubercled, bright brown, thicker at the base, a little attenuated towards the apex, about 6 in. long; scales elevated at the apex, bluntly tetragonal, truncate, very thick. (*Lamb.*) Mr. Lambert says: "Baron Humboldt has referred this species to *P. occidentalis* Swartz; but I have ventured to separate it, as the size of the cones, which may, in general, be relied on, as indicating a specific distinction in this genus, differs so much." Those described by Swartz are only 8 in. long, whereas those of *P. Montezumæ* are more than double that length.



§ xiii. *Leiophyllæ*.

Sect. Char. Leaves long, slender, soft, with caducous sheaths; cones tubercled.

‡ 37. *P. LEIOPHYLLA* Schiede et Deppe MSS. The smooth-leaved Pine.

Identification. Lamb. Pin., ed. 2., 1. t. 21.

Engravings. Lamb. Pin., ed. 2., 1. t. 21.; and our *fig.* 2186., from Lambert's figure.

Spec. Char., &c. Leaves in fives, very slender; sheaths deciduous. Cones ovate, stalked. Scales depressed, truncate. (*Lamb. Pin.*) Bud closely resembling that of *P. canariensis*. (*fig.* 2162. in p. 2261.) Leaves, in the Dropmore and Boyton specimens, from 5 in. to 6 in. in length, very slender, and pendent, closely set on the branches, and forming large tufts at the extremities of the shoots. The stem and old wood readily emit leaves and shoots from adventitious buds. A native of Mexico, between Cruzhlanca and Jalacinga, in the cold region.

Description. Branchlets covered with a deciduous epidermis. Buds imbricated with lanceolate, acuminate, brown scales, scarious, white, and torn at the margin. Leaves in fives, very slender, triquetrous, mucronate; bicanali-

culate above, flattish beneath, smooth; angles slightly serrated, furnished with conspicuous dotted lines, wavy, not flexuose; light green, 4 in. long; sheaths composed of many ligulate, ciliated, and torn, bright brown, loosely obvolute, caducous scales. Cones ovate, pendulous, 2 in. long, on a very short, thick, peduncle; scales dilated at the apex, trapezoidal, truncate, depressed, a little hollowed; in the young cone, elongated and mucronate. Seeds small; wing oblong, brown. (*Lamb.*) This species was discovered by MM. Schiede and Deppe; and Mr. Lambert's figure was taken from specimens communicated by them. The leaves, Mr. Lambert says, are precisely those of the *Strobilus* tribe, with which this species also agrees in having a caducous sheath. Mr. Lambert sent seeds to Dropmore; where there are three plants raised from them; one



2187

of which was, in 1837, 6 ft. high, and had stood out six years without any protection; and two others, 12 ft. and 14 ft. high, which are covered every winter in the same manner as *P. longifolia*, and which have been more injured than those which were left without protection. Fig. 2187. is a portrait of one of the Dropmore trees, which, in 1837, was 14 ft. high.



2186

§ xiv. Cémbraë.

Sect. Char. Leaves short, nearly straight, with longitudinal silvery channels. Cone, with the scales not thickened at the apex, globose, about as long as the leaves.

‡ 38. *P. CÉMBRA* L. The *Cembran* Pine.

Identification. Lin. Sp. Pl., 1419, Syst. ed. Reich., 4. p. 173.; M.H. Dict., No. 6.; Pall. Fl. Ross., 1. p. 3.; Vill. Dauph., 3. p. 806.; Ait. Hort. Kew., 3. p. 369.; Willd. Berol. Baumz., p. 212.; Lamb. Pin., ed. 3., 1. t. 30, 31.; N. Du Ham., 5. p. 248.; Hayne Dend., p. 174.; Höss Anleit., p. 11.; Lawson's Manual, p. 358.; Bon Jard., 1837, p. 977.; Loud. Cat., ed. 1836.

Synonymes. *P. fallis quinis*, &c., *Gmel. 8b.*, 1. p. 179.; *Du Ham. Arb.*, 2. p. 197.; *Haub. Helt.*, No. 1659.; *Du Roi Herb.*, ed. Bott., 4. p. 29.; *P. sativa Annon. Rus.*, p. 178.; *P. sylvestris*, &c., *Bauh. Pin.*, 491.; *P. sylvestris Cémbra*, *Can. Epit.*, p. 42.; *Larix sempervirens*, &c., *Breyer*, in *Act. Nat. Cur. Göt.*, 7. 8.; *Pinkster Aelsh*, &c., *Reil. Conifer.*, p. 20. b. 21.; *Turda arbor*, *Cémbra Italbrun*, *Dalc. Hist.*, 1. p. 47.; *Aphernousli Pine*, five-leaved Pine, the Siberian Stone Pine, the Swiss Stone Pine; *Arolos*, in Savoy; *Alvics*, in Switzerland; *Cembra*, in Dauphiné; *Ceinbrot*, *Esouve*, *Tinier*, *Fr.*; *Zürbelkiefer*, *Ger.*; *Kedr*, *Rus.* (see *Pall. Fl. Ross.*)

Engravings. *Pall. Ross.*, 1. t. 2.; *Gmel. 8b.*, 1. t. 39.; *Du Ham. Arb.*, 2. t. 32.; *Breyer*, *Obs.*, 2. t. 1. f. 3, 4, 5.; *Lamb. Pin.*, ed. 2., 1. t. 30, 31.; *N. Du Ham.*, 5. t. 77. f. 1.; our fig. 2191., to our usual scale; *Fig. 2186.* to 2190., of the natural size; all from Dropmore specimens; and the plate of this tree in our last Volume.

Spec. Char., &c. Leaves in fives; sheaths deciduous. Cones ovate-erect, about as long as the leaves, and having, when young, the scales pubescent; the wings of the seed obliterated; anthers having a kidney-shaped crest. (*Louis.*) Buds, in the Dropmore specimens, from $\frac{1}{4}$ in. to $\frac{3}{8}$ in. broad; globose, with a long narrow point; white, and without resin; not surrounded by smaller buds (see fig. 2188.) Cones about 3 in. long, and $2\frac{1}{2}$ in. broad. Scales 1 in. long, and about the same width in the widest part. Seed larger than that of any other species of *Pinus*, except *P. Pinea*, $\frac{1}{4}$ in. long, and $\frac{1}{4}$ in. broad in the widest part, somewhat triangular, and wedge-shaped; 2189

without wings, and having, probably from abortion, a very hard shell, containing an eatable, oily, white kernel, agreeable to the taste. Cotyledons 11 to 13 (see fig. 2189.). A native of Switzerland and Siberia; flowering in May, and ripening its cones in the November of the following year. Introduced in 1746.

Varieties.

‡ *P. C. 1 sibirica*; *P. Cembra* Lodd. Cat., ed. 1837; *Kedr*, *Pall.*; *Cedar* of some authors; the *Siberian Stone Pine*, or *Siberian Cedar*, *Hort.*—The cones are said to be longer, and the scales larger, than in the Swiss variety; the leaves are, also, rather shorter; and the plant is of much slower growth in England. According to Pallas, this is a lofty tree, and not found beyond the Lena. In general appearance, it resembles *P. sylvestris*, but is more tufted, from the branches being thinner, and from the number and length of the persistent leaves. Trunk straight, often 120 ft. high, and 3 ft. in diameter near the base; in old trees, naked till near the top. Bark smoother, greyer, and

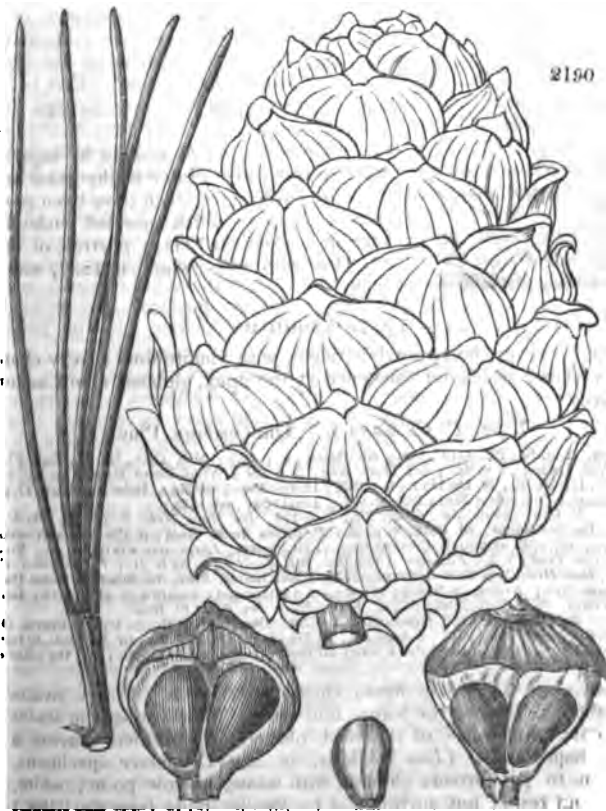

more resinous than in *P. sylvestris*. Branches commonly disposed 3 or 4 in a whorl, sometimes scattered, more slender and spreading than in the Scotch pine; covered with a greyish ash-coloured furrowed bark, marked by the cicatrices of the fallen leaves. Leaves

in fives, rarely in fours or threes; at first sheathed, afterwards naked, very long, sharply triquetrous; the 2 angles rough, capillate, sharp at the point. The wood of the cembra is light, soft, white, resinous, loose in the fibres, not tough. The resin, which may be collected in quantities, is somewhat of the odour of citron, and is pellucid, yellowish, and hard. (*Pall.*)

- ‡ P. C. 2 *pygmaea*; *P. C. pumila* *Pall. Ross.*; *Slanez, Russ.*—According to Pallas, the trunk of this variety does not exceed 2 in. in thickness, and it is rarely above 6 ft. in height; the branches being not more than 1 in. in diameter. Some specimens are much lower in height, prostrate, and shrubby. The branches of this variety are more slender, the bark rougher and yellower, and the leaves more crowded, and shorter, than those of the species. The cones are scarcely larger than those of *P. sylvestris*; and the scales and seeds less than those of *P. C. sibirica*. In the east of Siberia, this variety is found covering rocky mountains, which are so barren, that herbage of no kind will grow on them; and also in valleys, where, however, it never attains the size of a tree. Those found on the mountains are much more resinous and balsamic. The young shoots are reckoned an excellent antiscorbutic, and are much more agreeable in taste than those of the *Abies*. Pallas had a specimen from Montanvert, in Savoy, which resembled the Siberian variety in the number and closeness of the leaves, only they were much thicker. (*Pall.*) There is a plant at Dropmore which has been twenty years planted, and, in 1837, was not more than 6 in. high, which we presume to be this variety. The same may be said of a tree in Hopetoun Gardens, near Edinburgh, said to be upwards of 100 years old, and which, in 1836, only measured 5 ft. 6 in. high.

- ‡ P. C. 3 *helvetica* *Lodd. Cat.*, ed. 1836; the Swiss, Cembra, or Stone Pine; has the cones short and roundish, with close scales; and the plants are of more vigorous growth than the Siberian variety; the wood, also, is said to be more fragrant. This is much the commonest form of *P. Cembra* in British gardens; and it has been treated as a species by Du Hamel and Haller. In the Briançonnais, this variety is called *Alviès*; and in Savoy, *Aroles*. In Dauphiné, it has a different name in almost every village. (See Villars's *Plantes du Dauphiné*, iv. p. 807.) In Kasthofer's *Voyage dans les petits Cantons, et dans les Alpes Rhétiennes*, it appears that this variety grows at the elevation of 6825 ft. above the level of the sea; and it vegetates there so slowly, that it does not increase more than a span (9 in.) in height in six years. A tree, the trunk of which was 19 in. in diameter, when cut down, was found to have 353 concentric circles. The wood is very fragrant, and retains its odour for centuries. In the ruins of the ancient Château of Tarasp, Kasthofer found the greater number of the chambers ornamented with this wood, which, after having remained there for centuries, still continued to exhale its delicious perfume. (*Voy.*, &c., p. 196.) This odoriferous property in the wood, while it is agreeable to man, is so offensive to bugs and moths, as to deter them from establishing themselves in rooms where it is used, either as wainscoting, or as furniture. When this variety of *P. Cembra* was introduced into British gardens is uncertain, but it is now common in the nurseries.

Description. In England, *P. Cembra* is an erect tree, with a straight trunk, and a smooth bark. When standing singly, it is regularly furnished to the summit with whorls of branches, which are more persistent than the branches of most other species of *Abiétinæ*. The leaves are from 8 to 5 in. a sheath, three-ribbed; the ribs serrated, one of them green and shining, and the other two white and opaque. In most species of pine,

It has been observed that the leaves incline more towards the shoots which produce them during winter than in summer, as if to prevent the snow from lodging on them; and this is said to be much more conspicuously the case with the leaves of *P. Cembra* than with those of any other species. The male catkins are red, and appear at the base of the young shoots. According to Lambert, the flowers have a more beautiful appearance than in any other species of pine, being of a bright purple; and the unripe full-grown cones, he says, have a bloom upon them like that of a ripe Orleans plum. The tree is of remarkably slow growth in every stage of its progress, more especially when young; seldom advancing more, even in rich soils, than 1 ft. in a year (though, in the neighbourhood of Edinburgh, as will be hereafter noticed, it grows much faster); but it grows quicker when it becomes older. It is readily known from all the other species of pines by its narrow, conical, compact form, and the shortness of its silvery leaves, which form tufts at the extremities of the branches. In England, it is a formal, and we do not think it can be considered a handsome, tree: it presents to the eye a multiplicity of tufts of leaves, piled up one above another, of the same size, and equidistant; and every where of rather a dull green colour. The uniformity of shape is nowhere broken, except at the summit, where alone the cones are produced; and hence, as a mass, it may be characterised as formal and monotonous, without being grand. In proof of this, we may refer to a plate of this tree in our last Volume. In Siberia and Switzerland, trees such as those mentioned by Pallas as being 120 ft. in height, have a much more grand and picturesque appearance; and *fig.* 2192. is a portrait of one of these trees. The largest tree that we know of in England is the original plant at Whitton, which, in 1837, after being 91 years planted, was only 50 ft. high, with a trunk 1 ft. 6 in. in diameter.

This tree bears cones and ripens seeds every year; and, though it appears to have suffered from the soil round it having been raised above a foot in height, yet it still continues to grow with vigour.



2192

retaining its branches from the ground upwards. The tree at Dropmore is nearly as high, though not planted above forty years.

Geography, History, &c. *P. Cembra* is indigenous to the alps of Siberia, to Tartary, Switzerland, Italy, and to Dauphiné and other parts of France. According to Kasthofer, it is found to a greater height on the Swiss mountains, than any other species of pine or fir. (*Voy., &c.*, p. 150.) Vallars found it, in Dauphiné, on high mountains, growing with different varieties of *P. sylvestris*, but rare. According to Hoes, it grows on the alps of Hungary and Austria; and, according to Pallas, as we have seen above, it has a very extensive geographical range in Siberia. It was introduced into England by Archibald Duke of Argyll, in 1746; but whether from Siberia or Switzerland is uncertain, though, in all probability, from the former country; as the cones of the original tree, still existing at Whitton, answer better to the description of those of *P. C. helvética* than to those of *P. C. sibirica*. The Swiss variety was strongly recommended by the Rev. J. Harte, in his *Essays on Husbandry*, published in 1746; and it is not improbable that it was he who communicated the seeds to the Duke of Argyll, though we have no positive evidence on the subject. Mr. Lambert states that a great many seeds were brought from Switzerland about the end of the last century; and that more than 2000 plants, raised from part of them, were planted at Walcot Hall, the residence of Lord Clive, in Shropshire. These plantations are still in a healthy state, many of the trees having attained the height of 40 ft. or 50 ft., and producing cones. Several trees were also planted, at the same time, at Gledhow, near Leeds, where some of them still exist, and whence arose the name of Gledhow pine, which is often applied to this tree. In 1828, Mr. Lawson of Edinburgh imported a quantity of seeds of *P. Cembra* from Switzerland; and dispersed them throughout Scotland for experiment; raising, also, a great many plants in his own nursery. (*Quart. Journ. of Agric.*, i. p. 813.) In 1836, the plants sown in 1828 had, in several places in the neighbourhood of Edinburgh, attained the height of from 8 ft. to 12 ft. From this, Mr. Lawson very properly concludes that, though some varieties of *P. Cembra* grow remarkably slowly, yet *P. C. helvética*, after three or four years' growth, will make annual shoots from 1 ft. to 18 in., or even 2 ft., annually in length. There can therefore be no doubt, he says, but that this variety, from the high altitude at which it naturally grows, is well adapted to clothe the tops of many hitherto almost barren mountains in Scotland, not only with fresh and luxuriant vegetation, but with valuable timber. (*Man.*, p. 359.) The finest trees in the neighbourhood of London are at Whitton, Kew, Dropmore, and Mill Hill, at all which places they bear cones. The Gledhow pines were examined for us, in October, 1837, by Mr. Murray, nurseryman, Leeds. He found in the plantations at Gledhow several trees, most of which were of small dimensions, and going fast to decay; particularly those in exposed situations. The largest and best tree which he found was 35 ft. high, with a trunk 3 ft. 2 in. in circumference, at 3 ft. from the ground, after being planted from 45 to 50 years. It stands on a lawn sheltered from the north, east, and west, and exposed to the south. The tree is now abundant in the nurseries, and, being remarkably hardy, is likely to be soon generally distributed; but, owing to its very slow growth, it will be liable to be choked by the trees among which it is planted, unless greater attention be paid to thinning and pruning than is generally the case in ornamental plantations.

Properties and Uses. The wood of *P. Cembra* is very soft; and its grain is so fine, that it is scarcely perceptible. According to the *Nonness De Hamel*, it is very resinous, which is the cause of its agreeable fragrance. It is not commonly large enough to be used in carpentry; but in joinery it is of great value, as it is remarkably easy to be worked, and is of great durability. In Switzerland, it is very much used by turners; and the shepherds of the Swiss Cantons, and of the Tyrol, occupy their leisure hours

in carving; out of it numerous curious little figures of men and animals, which they sell in the towns, and which have found their way all over Europe. The wood is much used for wainscoting; having not only an agreeable light brown appearance, but retaining its odour, according to Kasthofer, for centuries. The kernel of the seed, in Dauphiné, *Vinars informis* /us, is eagerly sought after by a species of crow (*Corvus Caryocactes* L.), which shows an almost incredible degree of skill in breaking the hardest shells. In Switzerland, the seeds are used in some places as food, and in others as an article of luxury; and the shell being very hard, and requiring some time and skill to separate it from the kernel, the doing so forms an amusement for young persons in the long winter evenings; who, Kasthofer observes, show a degree of skill in it that might vie with that of the squirrel. In some places in the Tyrol, the seeds are bruised, and an oil obtained from them by expression. So abundant is this oil in comparison with that produced by other seeds, that, while a pound of flax seed yields only 2½ oz., 1 lb. of cembra seed yields 5 oz. Cembra oil is used both as food, and for burning in lamps; but, as the breaking of the seeds requires a long time, it is generally dearer than most other oils: it has a very agreeable flavour when newly made, but very soon becomes rancid. The shells of the kernels, steeped in any kind of spirits, yield a fine red colour. In Siberia, the seeds of the cembra are sometimes produced in immense quantities; but in other seasons there is scarcely any crop. In abundant years, they form, according to Gmelin, almost the sole winter food of the peasantry. The seeds, both in Siberia and Switzerland, are employed medicinally; and Gmelin relates a story of two captains of vessels, who were suffering dreadfully from the scurvy, and whose crews had almost all died of the same disease, being cured in a few days by eating abundantly of these seeds. In Britain, *P. Cembra* can only be considered as an ornamental tree; and, though we hold it to be scarcely possible for a pine to be otherwise than ornamental (if it were for no other reason than its being an evergreen), yet we cannot help, as we have already observed, considering the Cembran pine, when compared with other species, as rather monotonous, both in form and colour. The summit of the tree, however, and its purple cones, we acknowledge to be truly beautiful. That we may not run the slightest risk of injuring this tree, we may mention that Mr. Lambert, so far from entertaining the same opinions as we do respecting it, looks upon it as "one of the handsomest trees of the whole genus." (*Pine*, ed. 2., i. p. 49.)

Soil, Situation, &c. Though the Cembran pine, as we have seen, will grow in the poorest soils, and in the most elevated and exposed situations, where no other pine or fir will exist, yet it will not grow rapidly, except in a free soil, somewhat deep, and with a dry subsoil. This is rendered evident from the trees at Dropmore, which, though they cannot have been planted above half the time of the trees at Whitton and at Kew, are above 40 ft. high, with trunks from 1 ft. to 14 in. in diameter. The tree at Whitton is on very moist soil, and that at Kew on very dry poor soil. The soil at Dropmore is also dry, but it is not so much exhausted by the roots of other trees as the soil in the arboretum at Kew. All the varieties are propagated from imported seeds, which may be sown in the same autumn in which they are received; or, perhaps, kept in a rot heap for a year, as they lie two winters and one summer in the ground before germinating. The plants grow exceedingly slowly for 4 or 5 years, seldom attaining in that period a greater height than from 1 ft. to 2 ft. When they are to be removed to any distance, they are best kept in pots; but, the roots being small and numerous, large plants of *P. Cembra* transplant better (when they are not to be carried to too great a distance) than most other species of *Pinus*.

Statistics. *Pinus Cembra* in England. At Syon, it is 50 ft. high; in the White Elm Nursery, it is 14 ft. high; at Walton on Thames, it is 36 ft. high. In Surrey, at Framham Castle, 35 years planted,

it is 20 ft. high; at Claremont, it is 34 ft. high, the diameter of the trunk 1 ft. 6 in., and of the head 27 ft. In Bedfordshire, at Woburn Abbey, 25 years planted, it is 22 ft. high. In Berkshire, at Ditch Park, 35 years planted, it is 30 ft. high. In Buckinghamshire, at Temple House, 40 years planted, it is 20 ft. high. In Cheshire, at Eaton Hall, 8 years planted, it is 6 ft. high. In Hertfordshire, at Cashobury, 30 years planted, it is 20 ft. high; at Cheshunt, 10 years planted, it is 14 ft. high. In Oxfordshire, in the Oxford Botanic Garden, 30 years planted, it is 18 ft. high. In Staffordshire, at Trentham, 26 years planted, it is 23 ft. high. In Worcestershire, at Croose, 30 years planted, it is 45 ft. high. In Yorkshire, at Gledhow, 35 ft. high.

Pinus Cembra in Scotland. In Berwickshire, at the Hinsel, 5 years planted, it is 3 ft. 6 in. high. In Fifeshire, at Balcarra, it is 30 ft. high, and ripened seed in 1833, from which young plants have been raised.

Pinus Cembra in Ireland. At Dublin, in the Glasnevin Botanic Garden, 35 years planted, it is 16 ft. high; at Terenure, 15 years planted, it is 9 ft. high. In Antrim, at Craigmoe, it is 24 ft. high. In Louth, at Oriel Temple, 30 years planted, it is 34 ft. high.

Pinus Cembra in Foreign Countries. In France, near Paris, at Sceaux, 10 years planted, it is 18 ft. high. In Hanover, at Schwäbber, it is 60 ft. high; in the Göttingen Botanic Garden, 10 years planted, it is 10 ft. high. In Saxony, at Wörlitz, 50 years planted, it is 50 ft. high. In Cassel, at Wilhelmshoe, 60 years old, it has a trunk 1 ft. 6 in. in diameter. In Prussia, at Berlin, at Sans Souci, 30 years planted, it is 20 ft. high.

Commercial Statistics. Plants, in the London nurseries, are 2s. 6d. each; at Bollwyler, 2 francs each; and at New York, 2 dollars.

§ xv. *Strobi.*

Sect. Char. Leaves rather longer than in *Cembra*. Cones with the scales not thickened at the apex, pendulous, and much longer than the leaves.

‡ 39. *P. STROBUS* L. The Strobos, or Weymouth, Pine.

Identification. Lin. Sp. Pl., 1419, Syst., ed. Reich., 4. p. 174; Mill. Dict., No. 13; Hunt. Evol. Syl., p. 293; Wang. Beyt., 1. t. 1.; Alt. Hort. Kew., 3. p. 309; Du Roi Harbk., ed. Post., 2. p. 78; Mart. Arb. Amer., p. 101; Forst. Dict., 5. p. 361; Lamb. Pin., ed. 2., 1. t. 32; N. Du Ham., 5. p. 249; Pursh Fl. Amer. Sept., 2. p. 694; Hayne Dend., p. 176; Lawson's Manual, p. 360; Bon Jard., p. 77; Lodd. Cat., ed. 1836.

Synonymes. *P. foliis quinis*, &c., *Gron. Virg.*, 2. p. 159; *P. canadensis quinquefolia* Du Ham. Arb., 2. p. 127; *P. virginiana Pluk. Alm.*, p. 597; *Larix canadensis Tourm. Inst.*, p. 586; New England Pine, white Pine, Pumpkin Pine, Apple Pine, Sepling Pine, *Amer.*; Pin du Lord, Pin du Lord Weymouth, *Fr.*

Engravings. Wang. Beyt., 1. t. 1. f. 1.; Lam. Illust., t. 786. f. 3.; Lamb. Pin., ed. 2., 1. t. 32; Michx. N. Amer. Syl., 3. t. 145; N. Du Ham., 5. t. 76; our figs. 2193. to 2195., from specimens from Whitton, and the plate of the tree in our last Volume.

Spec. Char., &c. Leaves slender, without sheaths. Male catkins small.

Cone cylindrical, long, and pendulous. (*Michx.*) Buds from $\frac{1}{8}$ in.

to $\frac{1}{4}$ in. long, and from $\frac{1}{8}$ in. to $\frac{3}{8}$ in. broad; ovate, pointed, and

slightly resinous; surrounded by one or two small buds. (See fig. 2193.)

Leaves from 3 in. to 3 $\frac{1}{4}$ in. long. Cone (see fig. 2195.) from

5 in. to 6 in. long, and from 1 $\frac{1}{2}$ in. to 1 $\frac{3}{4}$ in. broad, on a peduncle

$\frac{3}{4}$ in. long; scales (see fig. 2194.) 1 $\frac{1}{2}$ in. long, and from $\frac{1}{2}$ in. to $\frac{3}{4}$ in.

broad. Seed $\frac{3}{4}$ in. long, and $\frac{1}{8}$ in. broad; obovate, pointed below,

with a wing which, including the seed, is about 1 in. long, and $\frac{1}{2}$ in.

broad, in the widest part. Cotyledons 6 to 10. A native of North

America. Introduced in 1705; and flowering in April.

Varieties.

‡ *P. S.* 2 *alba* Hort. has the leaves and bark much whiter than the species. There is a plant in the Horticultural Society's Garden, which, in 1837, after being 12 years planted, was 20 ft. high.

‡ *P. S.* 3 *brevifolia* Hort. has shorter leaves.

‡ *P. S.* 4 *compressa* Booth; *P. S. nova* Lodd. *Cat.*, ed. 1836; Floetbeck Weymouth Pine. — Also much shorter in the leaf, and probably the same as *P. S. brevifolia*.

Description. A tall tree, which, in America, according to Michaux, varies in height from 100 ft. to 180 ft., with a straight trunk, from about 4 ft. to 6 ft. or 7 ft. in diameter. The trunk is generally free from branches for two thirds or three fourths of its height; the branches are short, and in whorls, or disposed in stages one above another, nearly to the top, which consists of three or four upright branches, forming a small conical head. In rich strong loams, the tree does not grow so high, and assumes a more spreading shape; but it is still taller and more vigorous than most of the trees by which it is surrounded. The bark, on young trees, is smooth, and even polished; but,



2193

as the tree advances in age, it splits, and becomes rugged and grey, but does not fall off in scales like that of the other pines.

The leaves are from 3 in. to 4 in. long, straight, upright, slender, soft, triquetrous, of a fine light bluish green, marked with silvery longitudinal channels; scabrous and inconspicuously serrated on the margin; spreading in summer, but in winter contracted, and lying close to the branches. Sheaths and stipules none, or deciduous. Male catkins short, elliptic; pale purple, mixed with yellow, turning red before they fall; on long foot-

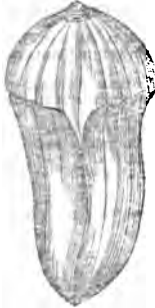

2194

stalks, and arranged like those of *P. australis*. Crest of the anthers very small, and composed of two erect very short bristles. Female catkins ovate-cylindrical; erect, on short peduncles when young, but when full grown pendulous, and from 4 in. to 6 in. long, slightly curved, and composed of thin smooth scales, rounded at the base, and partly covered with white resin, particularly on the tips of the scales; apex of the scales thickened. Seeds ovate, of a dull grey. The cone opens, to shed the seeds, in October of the second year; and in America, according to Michaux, part of the seeds are generally left adhering to the turpentine which exudes from the scales. The wood is soft, light, free from knots, and easily wrought; it is also durable, and not very liable to split when exposed to the sun: but it has little strength, gives a feeble hold to nails,

and sometimes swells from the humidity of the atmosphere; while, from the very great diminution of the trunk from the base to the summit, it is difficult to procure planks of great length and uniform diameter. The proportion of sap wood is very small; and, according to Michaux, a trunk 12 in. in diameter generally contains 11 in. of perfect wood. The wood of this tree is remarkably white when newly sawn into planks; whence the common American name for it of white pine. The rate of growth of this tree in Britain is, except in very favourable situations, slower than that of most European pines. Nevertheless, in the climate of London, it will attain the height of 12 ft. or 13 ft. in 10 years from the seed. When planted singly, like most other pines, it forms a branchy head; but, when drawn up among other trees of the same species, it has as clear a trunk in Britain as in America. The general appearance of the tree, when standing singly in English parks and pleasure-grounds, is well represented by fig. 2196., which is the portrait, to a scale of 24 ft. to 1 in., of a Weymouth pine in Studley Park, which, in 1836, was 60 ft. 6 in. high, with a trunk about 8 ft. in circumference, at 1 ft. from the ground.

Geography. According to Pursh, the white, or Weymouth, pine grows in fertile soil, on the sides of hills, from Canada to Virginia; attaining the largest size in the state of Vermont. Michaux informs us that the tree is diffused,

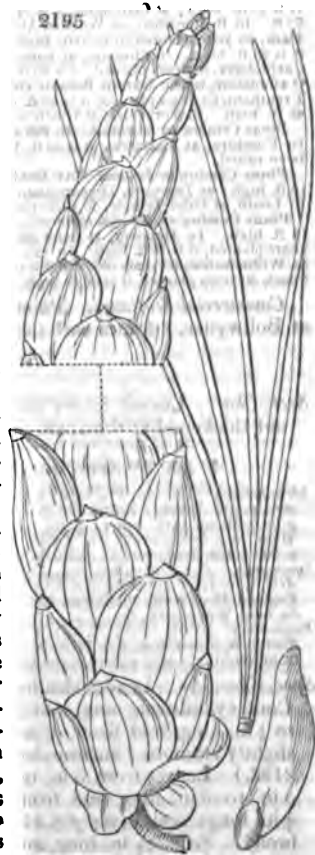

2195

though not uniformly, over a vast extent of country; but that it is incapable of supporting either intense heat or intense cold. The elder Michaux, after traversing 300 miles, on his return from Hudson's Bay, without perceiving a vestige of it, first observed it about 40 leagues from the mouth of the Mistassin, which discharges itself into the Lake St. John, in Canada, in N. lat. $48^{\circ} 50'$. Two degrees farther south, he found it common. It is, however, most abundant between N. lat. 48° and N. lat. 47° : farther south, it is found in the valleys and declivities of the Alleghanies, but will not grow at any distance from the mountains on either side, on account of the warmth of the climate. In New Hampshire, in the state of Vermont, and near the commencement of the river St. Lawrence, it attains its largest dimensions. "In these countries," says the younger Michaux, "I have seen it in very different situations; and it seems to accommodate itself to all varieties of soil, except such as consist wholly of sand, and such as are almost constantly submerged; but I have seen the largest specimens in the bottom of soft, friable, and fertile valleys, on the banks of rivers composed of deep, cool, black sand; and in swamps filled with the white cedar (*Cupressus thyoides*), and covered with a thick and constantly humid carpet of *Sphagnum*. Near Norridgewock, on the river Kennebeck, in one of these swamps which is accessible only in the middle of summer, I measured two trunks felled for canoes, of which one was 154 ft. long, and 54 in. in diameter; and the other 143 ft. long, and 44 in. in diameter, at 3 ft. from the ground. Mention is made, in Belknap's *History of New Hampshire*, of a white pine felled near the river Merrimac, 7 ft. 8 in. in diameter; and near Hollowell, I saw a stump exceeding 6 ft. in diameter. These enormous trees had probably reached the greatest height attained by the species, which is about 180 ft. I have been assured, by persons worthy of belief, that, in a few instances, they had felled individual trees of nearly this stature." (*Michx. North Amer. Syst.*, iii. p. 161.) Michaux adds that he has "always observed the influence of soil to be greater on resinous than on broad-leaved trees." The qualities of the white pine, in particular, are strikingly affected by it. In loose, deep, humid soils, it unites in the highest degree all the valuable properties by which it is characterised, especially lightness and fineness of texture, so that it may be smoothly cut in every direction; and hence, perhaps, is derived the name of pumpkin pine. On dry elevated lands, its wood is firmer and more resinous, with a coarser grain and more distant concentric circles, and it is then called sapling pine. In the district of Maine, and the province of Nova Scotia, the white pine has been observed to be the first to take possession of barren deserted lands, and the most hardy in resisting the impetuous gales from the ocean.

History. *Pinus Strobus* received its name from Linnæus, and was first cultivated in England by the Duchess of Beaufort, at Badmington, in 1705. Great quantities were soon afterwards planted at Longleat, in Wiltshire, the seat of Lord Weymouth, where the trees prospered amazingly, and whence the species received the name of the Weymouth pine. Several were also planted at Mersham Hatch, in Kent; and a number at Whitton, by the Duke of Argyll. These plants began to bear cones with perfect seeds about 1720; and the species has been since extensively raised by nurserymen, from the seeds produced at these places; and the plants have been thus distributed:



throughout the island. Miller says that the seeds were first brought to London for sale from Mersham Hatch, Sir Wyndham Knatchbull's seat, near Ashford, in Kent, in 1726. There were also cones, he says, produced at Longleat; "but it has been chiefly from the seeds of Sir Wyndham Knatchbull that the much greater number of these trees now in England have been raised; for, although there has annually been some of the seed brought from America, yet those have been few in comparison to the produce of the trees in Kent; and many of the trees which have been raised from the seeds of those trees now produce plenty of good seed, particularly those in the garden of His Grace the Duke of Argyll, at Whitton, which annually produces large quantities of cones, which His Grace most generously distributes to all the curious." (*Dict.*, ed. 7., 1759.) Many of the trees in these places are still in existence, and are from 70 ft. to 80 ft. high. There are also some remarkably fine specimens at Strathfieldsaye; some of them, according to Mitchell, had, in 1827, trunks 100 ft. high, and 10 ft. in circumference. The largest tree at Whitton was, in 1835, 81 ft. 6 in. high, with a trunk 11 ft. 8 in. in circumference at 2 ft. from the ground. This tree stands singly, and divides into a great many large woody limbs, so as to form a very irregular head. In Scotland, the Weymouth pine is considered rather tender; and, as it requires a better soil than most other species, it is not much planted for its timber. Sang observes that it is a plant of too delicate a habit ever to become a large or valuable tree in Scotland, in exposed situations; but that, where it is sheltered and properly treated, it forms a fine-looking single tree. In Ireland, according to Hayes, it was not introduced till about 1770; but there are trees of it in various places above 50 ft. high. The Weymouth pine is not very common in France; but there are trees at the Trianon, which, in 1834, were between 40 ft. and 50 ft. high, after being about the same number of years planted.

Properties and Uses. The wood of this species is more employed in America than that of any other pine. Throughout the northern states, at the time the younger Michaux published his *North American Sylva* (1819), seven tenths of the houses, except in the larger capitals, were of wood; and about three quarters of these were built almost entirely of white pine; and, even in the cities, the beams and principal woodwork of the houses were of this wood. "The ornamental work of the outer doors, the cornices and friezes of apartments, and the mouldings of fireplaces, all of which, in America, are elegantly wrought, are of this wood. It receives gilding well, and is, therefore, selected for looking-glass and picture frames. Sculptors employ it exclusively for the images that adorn the bows of vessels, for which they prefer the kind called the pumpkin pine. At Boston, and in other towns of the northern states, the inside of mahogany furniture and of trunks, the bottoms of Windsor chairs of an inferior quality, water pails, a great part of the boxes used for packing goods, the shelves of shops, and an endless variety of other objects, are made of white pine. In the district of Maine, it is employed for barrels to contain salted fish, especially the kind called the sapling pine, which is of a stronger consistence. For the magnificent wooden bridges over the Schuylkill at Philadelphia, and the Delaware at Trenton; and for those which unite Cambridge and Charleston with Boston, of which the first is 1500 ft., and the second 3000 ft., in length; the white pine has been chosen for its durability. It serves exclusively for the masts of the numerous vessels constructed in the northern and middle states; and for this purpose it would be difficult to replace it in North America. The principal superiority of white pine masts over those brought from Riga is their lightness; but they have less strength, and are said to decay more rapidly between decks, and at the point of intersection of the yards. This renders the long-leaved pine (*P. australis*) superior to the white pine, in the opinion of the greater part of the American shipbuilders; but some of them assert that the white pine would be equally durable, if the top were carefully protected from the weather. With this view, an experiment has been suggested, of a hole, several feet deep,

made in the top of the mast, filled with oil, and hermetically sealed; the oil is said to be absorbed in a few months. The bowsprits and yards of ships of war are of this species. The wood is not resinous enough to furnish turpentine for commerce." (*Michx.*) Before the American war, England is said to have furnished herself with masts from the United States; and she still completes from America the demand which cannot be supplied from the north of Europe. The finest timber of this species is brought from Maine, and particularly from the river Kennebeck. Soon after the establishment of the American colonies, England became sensible of the value of this resource, and solicitous for its preservation. In 1711 and 1721, severe ordinances were enacted, prohibiting the cutting of any trees proper for masts on the possessions of the crown. The order had reference to the vast countries bounded on the south by New Jersey, and on the north by the upper limit of Nova Scotia. "I am unable to say," adds Michaux, "with what degree of rigour it was enforced before the American revolution; but, for a space of 600 miles, from Philadelphia to a distance beyond Boston, I did not observe a single tree of the white pine large enough for the mast of a vessel of 600 tons." (*Michx.*) The white pine is also used extensively in America for clap-boards and shingles. The clap-boards are of an indeterminate length, 6 in wide, $\frac{1}{2}$ in. thick at one edge, and much thinner at the other; they form the exterior covering of the walls of the wooden houses, and are placed horizontally, lapping one over the other, so that the thinner edge is covered. The shingles are commonly 18 in. long, from 3 in. to 6 in. wide, $\frac{1}{2}$ in. thick at one end, and 1 line thick at the other: they should be free from knots, and made only of the perfect wood. These shingles are used instead of tiles to almost all the houses east of the river Hudson; but they only last 12 or 15 years. They are exported in great quantities to the West Indies. The timber of the Weymouth pine continues to be imported into Britain in immense quantities; but it is considered as very inferior to some of the other American pines, and to the pine timber of the north of Europe. In M'Culloch's *Dictionary of Commerce*, speaking of the white pine of America, as compared with the Baltic pine, an extract is given from the evidence of Mr. Copland, an extensive builder and timber-merchant, when examined before parliament as to the comparative value of European and American Timber. "The American pine is much inferior in quality, much softer in its nature, not so durable, and very liable to dry rot: indeed, it is not allowed by any professional man under government to be used; nor is it ever employed in the best buildings in London: it is only speculators that are induced to use it, from the price of it being much lower (in consequence of its exemption from duty) than the Baltic timber. If you were to lay two planks of American timber upon each other, in the course of a twelvemonth they would have the dry rot, almost invariably, to a certain extent." M'Culloch adds that "many passages to the same effect might be produced from the evidence of persons of the greatest experience in ship-building." (*M'Culloch's Com. Dict.*, art. Timber Trade.) The wood of Weymouth pines grown in England has been used for floors, and by cabinet-makers; but, as the species is generally valued as an ornamental tree, it is seldom cut down for timber. Its picturesque beauty, according to Gilpin, is not great. "It is admired," he says, "for its polished bark, though the painter's eye pays little attention to so trivial a circumstance, even when the tree is considered as a single object: nay, its polished bark rather depreciates its value, for the picturesque eye dwells with more pleasure on rough surfaces than on smooth: it sees more richness in them and more variety. But we object chiefly to the Weymouth pine on account of the regularity of its stem and the meagreness of its foliage. Its stem rises with perpendicular exactness; it rarely varies; and its branches issue with equal formality from its sides. Its foliage, too, is thin, and wants both richness and effect. If I were speaking, indeed, of this tree in composition, I might add that it may often appear to great advantage in a plantation. Contrast, we know, produces beauty, even from deformity itself. Opposed, therefore, to the wildness of other trees, the regularity of the Wey-

mouth pipe may have its beauty: its formality may be concealed. A few of its branches, hanging from a mass of heavier foliage, may appear light and feathery, while its spry head may often form an agreeable apex to a clump." (*For. Scen.*, i. p. 87.)

Soil, Situation, &c. We have already observed that the soil and situation for this tree ought to be better than for most other species of pines. Seeds are procured in abundance; and the plants, when sown in spring, come up the first year, and may be treated like those of the Scotch pine.

Statistics. In the Environs of London. At Whittan Place, there are many trees, the tallest of which is 81 ft. 6 in. high, and the diameter of the trunk 4 ft.; at York House, Twickenham, it is 48 ft. high, the diameter of the trunk 1 ft. 6 in., and of the head 18 ft.; at Chiswick Villa, there are various trees, from 50 ft. to 60 ft. high; at Abercorn Priory, near Stannore, it is 53 ft. high, diameter of the trunk 1 ft. 9 in., and of the head 30 ft. — South of London. In Dorsetshire, at Melbury Park, 40 years old, it is 36 ft. high; at Compton House, 60 years old, it is 80 ft. high, with a trunk 3 ft. in diameter. In Hampshire, at Alresford, 41 years planted, it is 53 ft. high; at Strathfieldsaye, it is 95 ft. high, with a trunk 4 ft. 6 in. in diameter. In Somersetshire, at Kingston, it is 95 ft. high, with a trunk 3 ft. in diameter. In Surrey, at Claremont, it is 60 ft. high, the diameter of the trunk 2 ft., and of the head 36 ft.; at Deepdene, 10 years planted, it is 32 ft. high. In Wiltshire, at Wardour Castle, 50 years planted, it is 60 ft. high, the diameter of the trunk 3 ft. 9 in., and of the head 57 ft. — North of London. In Bedfordshire, at Southhill, it is 45 ft. high, with a trunk 2 ft. 6 in. in diameter. In Berkshire, at Bear Wood, 14 years planted, it is 30 ft. high. In Buckinghamshire, at Temple House, 40 years planted, it is 50 ft. high. In Durham, at Southend, 40 years planted, it is 60 ft. high; at Stanwick Park is one with a trunk 2 ft. in diameter. In Leicestershire, at Elvaston Castle, 33 years planted, it is 42 ft. high. In Nottinghamshire, at Clumber Park, it is 54 ft. high, the diameter of the trunk 2 ft. 6 in., and of the head 44 ft.; at Walsfield Lodge, 12 years planted, it is 25 ft. high. In Shropshire, at Willey Park, 18 years planted, it is 28 ft. high. In Staffordshire, at Trentham, it is 50 ft. high. In Suffolk, at Elmborough Hall, 70 years planted, it is 70 ft. high, the diameter of the trunk 2 ft. 6 in., and of the head 50 ft. In Warwickshire, at Coombe Abbey, 60 years planted, it is 60 ft. high; the diameter of the trunk 3 ft., and of the head 33 ft. In Yorkshire, at Grimston, 12 years planted, it is 39 ft. high.

Pinus Scrobus in Scotland. In the Environs of Edinburgh. At Hopetoun House, it is 50 ft. high, the diameter of the trunk 2 ft. 10 in., and of the head 40 ft. — South of Edinburgh. In Ayrshire, at Dalquharran, 55 years planted, it is 68 ft. high, the diameter of the trunk 2 ft. In Berwickshire, at the Hirst, 20 years planted, it is 20 ft. high. In Renfrewshire, at Erskine House, it is 55 ft. high, with a trunk 2 ft. 4 in. in diameter. — North of Edinburgh. In Argyllshire, at Toward Castle, 15 years planted, it is 20 ft. high. In Banffshire, at Gordon Castle, it is 48 ft. high, the diameter of the trunk 2 ft. 6 in., and of the head 36 ft. In Clackmannanshire, in the garden of the Dollar Institution, 12 years planted, it is 20 ft. high. In Forfarshire, at Kinnaird Castle, 45 years planted, it is 45 ft. high, the diameter of the trunk 1 ft. 6 in.; at Courtachy Castle, 14 years planted, it is 15 ft. high. In Invernessshire, at Cowan, 30 years planted, it is 35 ft. high, the diameter of the trunk 1 ft., and of the head 25 ft. In Stirlingshire, at Blair Drummond, 120 years old, it is 73 ft. high, the diameter of the trunk 2 ft. 6 in., and of the head 42 ft.; at Brucefield, it is 60 ft. high, the diameter of the trunk 1 ft. 6 in., and of the head 30 ft.; at Callendar Park, 39 years planted, it is 45 ft. high.

Pinus Scrobus in Ireland. In Down, at Ballylandy, 60 years planted, it is 46 ft. high. In Fermagh, at Florence Court, 30 years planted, it is 55 ft. high. In Galway, at Coole, it is 40 ft. high, the diameter of the trunk 2 ft.

Pinus Scrobus in Foreign Countries. In France, near Paris, at Beauvais, 30 years planted, it is 40 ft. high, the diameter of the trunk 3 ft., and of the head 30 ft.; at Colombey, near Metz, 70 years planted, it is 60 ft. high, the diameter of the trunk 2 ft.; at M. Angot's, 29 years planted, it is 40 ft. high; in the Park at Clerveaux, 32 years planted, it is 71 ft. high. In Hanover, at Harbke, 10 years planted, it is 16 ft. high; at Schwöber, 80 years planted, it is 100 ft. high, the diameter of the trunk 3 ft. In Saxony, at Wörlitz, 60 years planted, it is 80 ft. high, the diameter of the trunk 4 ft. 6 in., and of the head 40 ft. In Cassel, at Wilhelmshoe, 60 years old, it has a trunk 4 ft. in diameter. In Bavaria, in the Botanic Garden at Munich, 18 years planted, it is 20 ft. high; in the English Garden, 25 years planted, it is 30 ft. high. In Austria, at Vienna, at Luxemburg, 30 years planted, it is 25 ft. high; in Rosenthal's Nursery, 60 years planted, it is 40 ft. high; at Hadersdorf, 50 years planted, it is 40 ft. high; at Brück on the Leytha, 30 years planted, it is 40 ft. high. In Prussia, at Berlin, at Sans Souci, 45 years planted, it is 40 ft. high; in the Pfauen Insel, 40 years planted, it is 50 ft. high. In Italy, at Deslo, near Monza, it is 70 ft. high, the diameter of the trunk 2 ft. 6 in., and of the head 30 ft.

Commercial Statistics. Plants, in the London nurseries, are, per thousand, 1 year's seedlings, 8s.; 2 years' seedlings, 12s.; 1 year's transplanted, 20s.; and transplanted plants from 9 in. to 12 in. high, 50s. At Bollwyller, plants are from 1 franc to 2 francs each; or, per hundred, 4 years old and transplanted, 30s. At New York, plants are from 50 cents to 75 cents, and as high as 1 dollar each, according to their size.

‡ 40. *P. (S.) EXCELSA Wallich.* The lofty, or *Bhotan*, Pine.

Identification. Wall. Pl. As. Rat., t. 201.; Lamb. Pin., 1. t. 33.; Royle Illust.; Lawson's Manual, p. 363. *Synonymes* *P. Dicksonii* Hort.; Chilla, or Chylla, *Himalayas*; Kuel, *Sirmone and Gurwal*; Lem-ching, *Blatas*; *Racstila*, or King of the Firs, *Hindustan*. *Engmanns.* Wall. Pl. As. Rat., t. 201.; Lamb. Pin., 1. t. 33.; our fig. 2199., to our usual scale; and figs. 2197. and 2198., of the natural size, from Wallich, Lambert, and from living specimens.

Spec. Char., &c. Leaves in fives, very long, and slender, loose. Crest of the anthers roundish, truncate; simple, lacerated. Cones cylindrical, smooth, pendulous, longer than the leaves. (*Wall.*) Buds, on the tree in the Hor-



ticultural Society's Garden, $\frac{1}{4}$ in. long and $\frac{1}{8}$ in. broad; conical, with straight sides, and pointed. (Fig. 2197.) Leaves rather more than 6 in. long. Cone 9 in. long, and 2 in. broad, with a footstalk 1 in. long; scale $1\frac{1}{2}$ in. long, and $1\frac{1}{4}$ in. broad. Seeds $\frac{1}{8}$ in. long, and $\frac{3}{8}$ in. broad; with the wing, $1\frac{1}{2}$ in. long, and $\frac{3}{8}$ in. broad. A native of Nepal, on mountains. Introduced in 1823.

2197 *Description.* A tall, handsome, pyramidal tree, attaining the height of from 90 ft. to 120 ft. Branches numerous, ascending, divided, disposed in whorls. Bark entire, smooth, soft, pale grey. Wood white, abounding in a liquid resin. Leaves in fives, very long, slender, triquetrous, loose; glaucous green, pliable; 5 in. to 7 in. long, roughish on the angles from small teeth; furnished at the apex with a small callous mucro, crowded on the branches, particularly towards the apex; bicanaliculate above, flat beneath; sheaths about $\frac{1}{4}$ in. long, caducous, imbricated with numerous, linear-oblong, brown, membranaceous scales. Catkins terminal, with numerous membranaceous brown scales at the base; male ovate, short, obtuse, sessile, dense, collected into a head about 3 lines long, and 1 in. thick. Stamens monadelphous. Anthers very short roundish, opening below longitudinally, filled with sulphur-coloured pollen; crest small, roundish, simple, membranaceous; dark-brown, fringed and torn on the margin; female oblong, cylindrical, in threes or fours, erect, when young pedunculate; scales broad, roundish, imbricated inwards, coriaceous, thick, margined, smooth. Cones 3 or 4 together, cylindrical, pedunculate, naked, smooth; $6\frac{1}{4}$ in. long, pendulous when ripe, 2 in. in diameter, somewhat attenuated towards the apex; scales broad, wedge-shaped, coriaceous, thick, closely imbricated, smooth; light brown; apiculate above, with a short, thick, obtuse, dark brown mucro. Seeds ovate, compressed on both sides; testa bony, black, marked with grey spots; wing oblong-obtuse, membranaceous, ferruginous, somewhat cimeter-shaped, reticulate. (*Lamb.*) *P. excelsa*, Mr. Lambert observes, approaches so near in habit, and in the shape of its cones, to *P. Strabus*, that, were it not for the simple, round, membranaceous crest of the anthers, it would be almost impossible to distinguish them specifically. The leaves are longer than in *P. Strabus*, and the cones are thicker. Dr.

2198

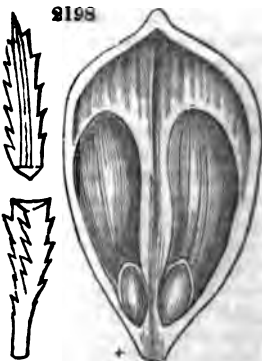

Royle makes a similar remark as to the resemblance of this tree to *P. Strôbus*, and adds "that it is remarkable for its drooping branches, whence it is frequently called the "weeping fir," by travellers in the Himalayas. It is found in company with the deodar cedar at Narainhetty, in Nepal, and at Simla, Theog, &c., and in the Bhootea Pergunnahs of Kamaon. Dr. Wallich mentions a variety, if not a species, still nearer to *P. Strôbus*, at Bainpa and Toka, in Nepal. (*Royle Illust.*) The rate of growth of this tree, in the climate of London, appears to be nearly the same as that of *P. Strôbus*. A plant in the Horticultural Society's Garden, of which *fig. 2202.* is a portrait, 8 years planted, was, in 1837, 12 ft. high; one at Dropmore, of which *fig. 2201.* is a portrait, the same age and 10 ft. high, has produced a cone; and one in the Kinnoul Nursery, in the neighbourhood of Perth, was, in 1836, 15 ft. high. *P. excelsa* is frequent both in Upper Nepal and Bothsam. In the latter country, its timber is preferred by the inhabitants to that of every other pine. It yields in great quantities a

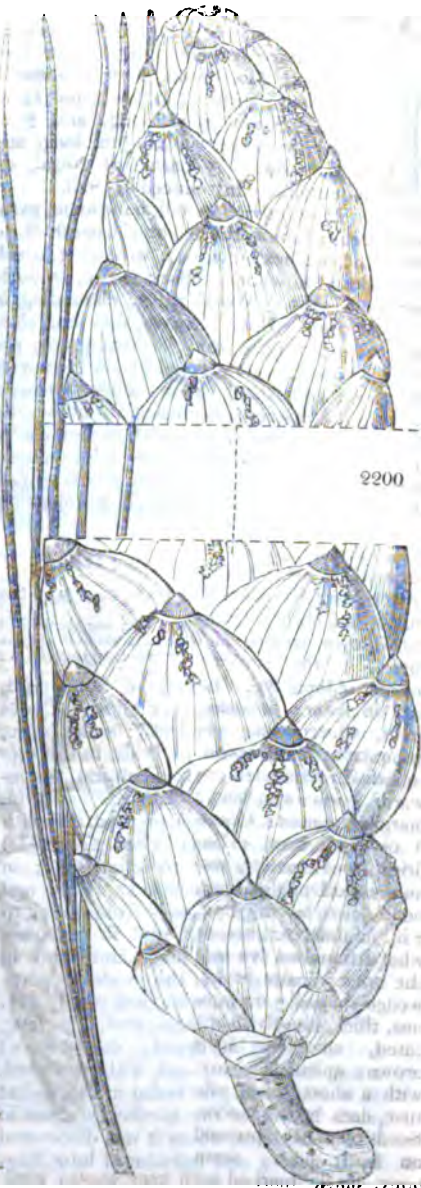
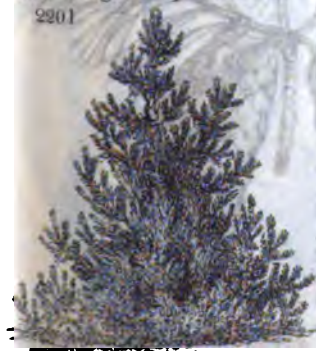

pure and limpid turpentine, by the slightest incision. The scales of the cone also exhibit turpentine, see *fig. 2200.* to the natural size. The species was introduced into England by Dr. Wallich about 1827; and several plants were raised by Mr. Lambert at Boyton, and in the Horticultural Society's Garden, in that year. Some appear, according to Mr. Lawson, to have been raised, also, in the Glasgow Botanic Garden. Plants, which are rather rare in the London nurseries, are 21s. each.



♀ 41. *P. (S.) LAMBERTIANA* Dougl. *The gigantic, or Lambert's, Pine.*

Identification. Dougl. in Lin. Trans., 15. p. 500.; Lamb. Pin., ed. 2., 1. t. 34.; Lawson's Manual, p. 361.; Lodd. Cat., ed. 1836.

Engravings. Lamb. Pin., ed. 2., t. 34.; our fig. 2206., to our usual scale; and figs. 2203. to 2205., of the natural size; the cone and scale from Douglas's specimens in the Horticultural Society's herbarium, and the buds and leaves from the tree in the Horticultural Society's Garden.

Spec. Char., &c. Leaves in fives, rigid, roughish; sheaths very short. Cones thick, very long, cylindrical; scales loose, roundish. (*Douglas.*) Buds, in the specimen from the Horticultural Society's Garden, $\frac{1}{2}$ in. long, and $\frac{1}{2}$ in. broad; roundish, pointed, and with 3 smaller buds. (See fig. 2203.) Leaves $2\frac{1}{2}$ in. to 3 in. long; in Douglas's specimens, $4\frac{1}{2}$ in. and 5 in. long. Cones from 14 in. to 16 in. long, and said to be sometimes 18 in. long, and 4 in. in diameter in the widest part; scales $1\frac{1}{2}$ in. wide, and nearly 2 in. long. Seed large, oval, $\frac{1}{2}$ in. long, and nearly $\frac{3}{4}$ in. broad; dark brown: wing dark brown, and, with the seed, $1\frac{1}{2}$ in. long, and $\frac{1}{2}$ in. broad in the widest part. Native of the north-west coast of North America, where it was discovered by Douglas; and introduced into England in 1827.



Description. According to Douglas, "the trunk of *P. Lambertiana* grows from 150 ft. to above 200 ft. in height, varying from 20 ft. to near 60 ft. in circumference. One specimen, which had been blown down by the wind, and which was certainly not the largest, was of the following dimensions:— Its entire length was 215 ft.; its circumference, at 3 ft. from the ground, was 57 ft. 9 in., and at 134 ft. from the ground, 17 ft. 5 in. The trunk is unusually straight, and

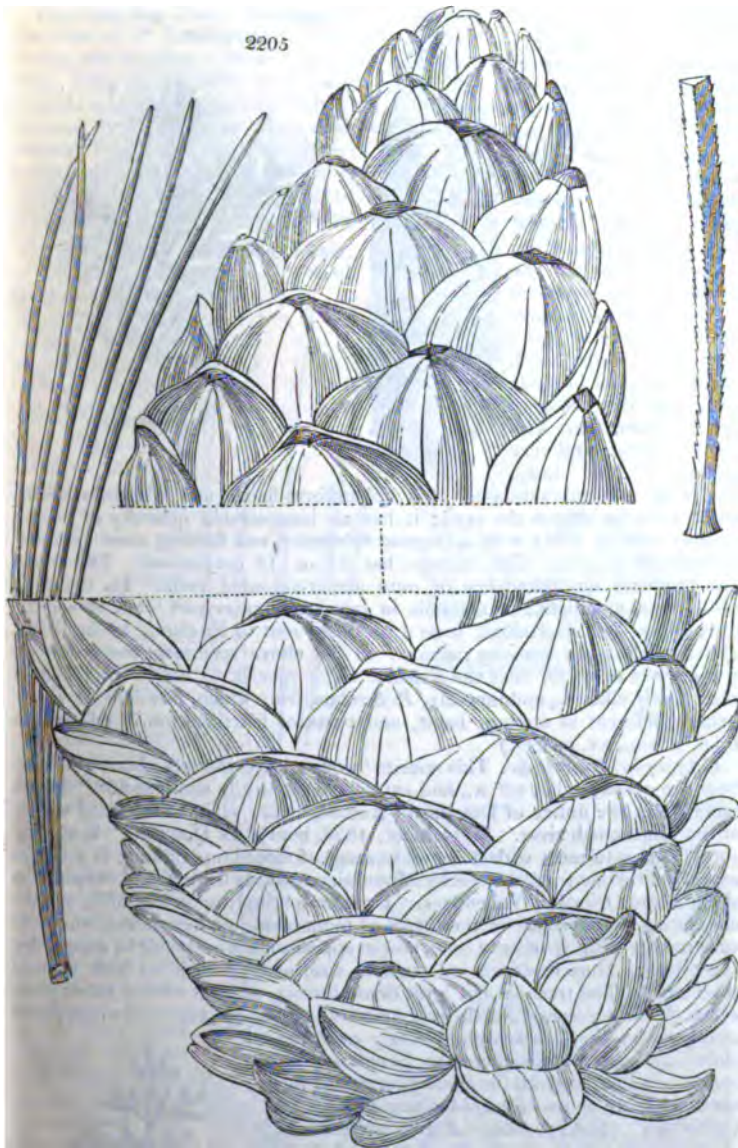

destitute of branches about two thirds of its height. The bark is uncommonly smooth for such large timber, of a light brown colour on the south, and bleached on the north, side. The branches are pendulous, and form an open pyramidal head, with that appearance which is peculiar to the *A'bies* tribe. The leaves are between 4 in. and 5 in. long, and grow in fives, with short deciduous sheaths, like those of *P. Stròbus*: they are rigid, of a bright green colour, but not glossy, and, from minute denticulations of the margin, are scabrous to the touch. The cones are pendulous from the extremities of the branches: they

are two years in acquiring their full growth; they are at first upright, and do not begin to droop till the second year. When young, they have a very taper figure. When ripe, they are about 11 in. in circumference at the thickest part, and vary from 12 in. to 16 in. in length. The scales are lax, rounded at the apex, and perfectly destitute of prickles: the seeds large, 8 lines long, and 4 broad; oval; and, like those of the *P. Pinea*, their kernels are sweet, and very pleasant to the taste.



2206



The wing is membranaceous, of a dolabriform figure, and fuliginous colour, about twice as long as the seed; it has an innumerable quantity of minute sinuous vessels, filled with a crimson substance, and forming most beautiful microscopic objects. The embryo has 12 or 13 cotyledons. The whole tree produces an abundance of pure amber-coloured resin. Its timber is white, soft, and light; it abounds in turpentine reservoirs; and its specific gravity has been ascertained, from a specimen sent to England, to be 0.463. The annual layers are very narrow: in the above specimen, there were 56 in the space of 4½ in. next the outside. The species to which this pine is most nearly allied is, undoubtedly, *P. Stròbus*, from which, however, it is extremely different in station, habit, and parts of fructification." (*Dougl. in Linn. Trans.*, xv. p. 499.)

Geography, History, &c. This species "covers large districts about 100 miles from the ocean, in lat. 43° N., and extends as far to the south as 40°." It first came under the notice of Douglas in August, 1825, while at the head waters of the Multnomah river. In October, 1826, continues Douglas, "it was my good fortune to meet with it beyond a range of mountains running in a south-western direction from the Rocky Mountains towards the sea, and terminating at the Cape Orford of Vancouver. It grows sparingly upon low hills, and the undulating country east of the range of mountains just mentioned, where the soil consists entirely of pure sand, and in appearance is incapable of supporting vegetation. Here it attains its greatest size, and perfects its fruit in most abundance. The trees do not form dense forests, as most of the other pines which clothe the face of North-west America; but, like *P. resinosa*, which grows among them, they are scattered singly over the plains, and may be considered to form a sort of connecting link between the gloomy forests of the north and the more tropical-looking verdure of California." (*Ibid.*, p. 498.) Plants were raised of this species in the Horticultural Society's Garden in 1827, and distributed in the following year; but it is remarkable that the greater part of them have since died, generally when they were about 4 ft. or 5 ft. in height. Notwithstanding this, the species does not appear to be much more tender than *P. Stròbus*. The largest existing plant that we know of is in the garden of William Wells, Esq., at Redleaf, where, having been sown in 1829, it is 10 ft. 2 in. high. One in the Chiswick Garden, sown the same year, and of which *fig.* 2207. is a portrait, is only 6 ft. 6 in. high.



Properties and Uses. The resin, Douglas observes, "which exudes from the trees of *P. Lambertiana*, when they are partly burned, loses its usual flavour, and acquires a sweet taste; in which state it is used by the natives as sugar, being mixed with their food. The seeds are eaten roasted, or are pounded into coarse cakes for their winter store. I have, since my return, been informed by Mr. Menzies, that, when he was on the coast of California with Captain Vancouver, in 1793, seeds of a large pine, resembling those of the stone pine, were served at the dessert by the Spanish priests resident there. These were, no doubt, the produce of the species now noticed. The vernacular name of it in the language of the Umptqua Indians, is *nât-cleh*." (*Ibid.*, p. 499.)

‡ 42. *P. (S.) MONTICOLA* Dougl. The Mountain, or short-leaved Weymouth, Pine.

Identification. Lamb. Pin. ed. 2., vol. 2., after *P. Sabiniæna*, 3. t. 87.

Engraving. Lamb. Pin., 3. t. 87., and our figs. 2208. and 2209., from Douglas's specimens in the herbarium of the Horticultural Society.

Spec. Charac., &c.

Leaves in fives, short, smoothish, obtuse. Cones cylindrical, and smooth; scales loose, pointed. (*D. Don.*) Buds, in the plant in the London Horticultural Society's Garden, small, resembling those of *P. Lambertiana*. Leaves from $3\frac{1}{2}$ in. to 4 in. long, without the sheaths. Cone, from Douglas's specimen, 7 in. long, and $1\frac{1}{2}$ in. broad; rather obtuse at the point; scales $\frac{1}{2}$ in. broad at the widest part, and from $1\frac{1}{2}$ in. to 2 in. long, and covered with resin. Seed small, $\frac{1}{8}$ in. long, and $\frac{1}{16}$ in. broad; with the wing, $1\frac{1}{2}$ in. long, and $\frac{1}{4}$ in. broad. Cotyledons? A native of the high mountains, at the Grand Rapids of the Columbia; and in California, on the

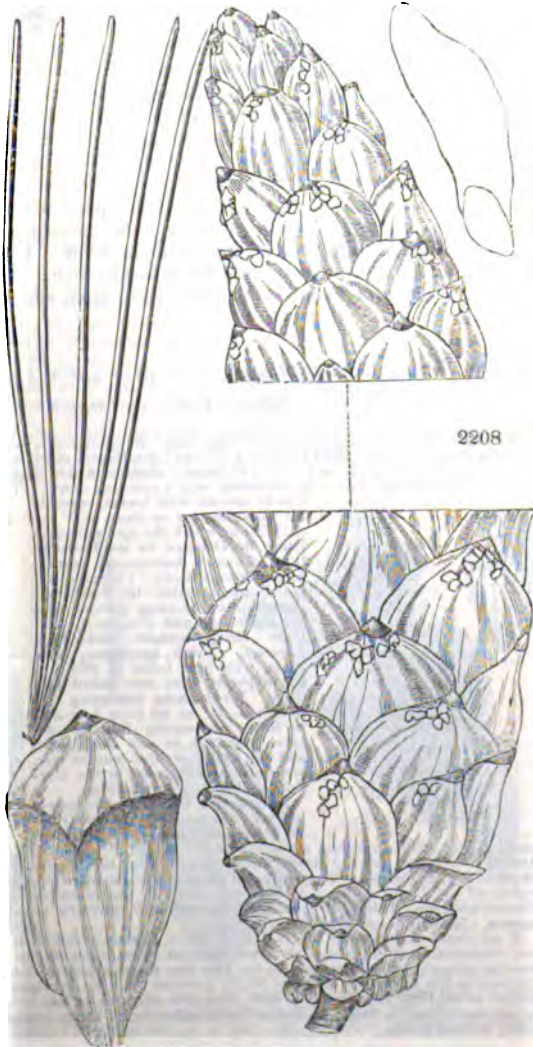

rocky banks of the Spokane river. Discovered by Douglas, and introduced in 1831.

Description, &c. A resinous tree, with brownish-coloured bark. Leaves in fives, triquetrous, obtuse; bicanaliculate above, carinate below, with a blunt elevated line; obsolete crenulated on the margin; smoothish, glaucous green; $1\frac{1}{4}$ in. to 3 in. long. Sheaths imbricated with elliptic-oblong, obtuse, thinly membranaceous, loose, bright brown scales, quickly falling off. Cones cylindrical, smooth, 6 in. to 8 in. long, generally in whorls; scales spatulate, apiculate; slightly convex beneath, dark ash-yellow. Seeds oval, with a crustaceous testa; wing hatchet-shaped, obtuse, striated, dull yellow, shining. (*Lamb.*) Except in its much shorter and smoother leaves, this species differs but little from *P. Ströbus*, of which it may prove to be only a variety; but, until an opportunity occurs of examining the male catkins, and ascertaining other particulars, it is considered best to keep it distinct. Judging from the appearance of the specimens sent home by Douglas, the tree must abound in resin. The plant in the Horticultural Society's Garden is only a few inches high. Among Douglas's specimens, there is a variety with red cones, from which no plants have yet been raised.



App. i. *Species of Pine which are not yet introduced, and of which little is known.*

P. contorta Douglas. *The twisted-branched Pine.* Buds roundish, with a blunt point, covered with resin, and brown. Leaves 2 in a sheath, 2 in. long; sheath very short, imbricated, black. Cones from 2 in. to 2½ in. long; and from ½ in. to 1 in. broad; scales with the apices having a depressed lateral rib, terminating in a blunt point, furnished with a caducous mucro. The shoots are regularly and



closely covered with leaves, much in the same manner as those of *P. (a.) pumilio*, to which the specimen sent home by Douglas, in the Horticultural Society's herbarium, bears a general resemblance. This pine was found by Douglas in North-west America, on swampy ground near the sea coast; and, abundantly, near Cape Disappointment and Cape Lookout. Dried specimens, with cones, were sent home in 1825.6-7; but no plants, have been raised from them. No remarks respecting this species, as far as we have been able to learn, are among Douglas's papers. *Fig. 2210.*, to our usual scale, and *fig. 2211.*, of the natural size, are from the specimens in the Horticultural Society's herbarium.

P. squamösa Bosc does not appear to have been noticed by any other botanist. Leaves 2 in a sheath, less glaucous, shorter, stiffer, and less numerous, than those of *P. sylvestris*. The buds are large, obtuse, and very resinous; and the cones, which are of a clear brown colour, are shorter and smaller than those of *P. a. genevensis*. The pyramidal points of the scales are long, and bent backwards. It is a native of the Lower Alps; and there are plants in the Jardin des Plantes, and in some of the French nurseries. It is, in all probability, a variety of *P. sylvestris*, though Bosc considers it a distinct species. (*Nouv. Cours d'Agriç.*, art. Pin.)

P. turbinata Bosc has the leaves 2 in a sheath, slightly glaucous, scarcely 1 in. long. The buds are very small, reddish, fringed, and not resinous. The cones are in whorls from 2 to 5 together, sharply pointed, longer than the leaves, with the scales almost square, and not pyramidal. Bosc thinks that it is probably a native of North America; but his description is taken from a tree in the garden of the Petit Trianon, about 40 ft. high, the only one he had seen. He adds that its general appearance resembles that of *P. mitis*; but it differs in its leaves being much shorter, and its cones being without spines.

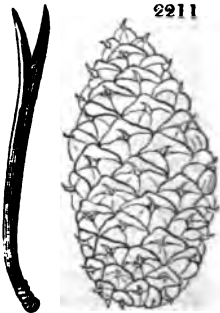

GENUS II.



ABIES D. DON. THE SPRUCE FIR. *Lin. Syst. Monœ'cia Monadélphia.*

Identification. D. Don in Lamb. Pin., vol. iii.

Synonymes. Pinus of Lin. and others, in part; Picea Link in Abhand. König. Akad. Wissens. Berlin, p. 179, for 1827; Abies of Tourn., Mill., and others, in part; Picea of the Ancients; Sapin Epicea, Fr.; Fichtenbaum, Ger.; Abiete, Ital.; Abieto, Span.

Derivation. From abeo, to rise; alluding to the aspiring habit of growth of the tree; or, according to some, from epios, a pear tree; in allusion to the form of the fruit.

Description. Evergreen trees; natives of Europe, Asia, and America; remarkable for their tall, erect, pyramidal forms, and profusion of foliage. One or more species are useful, and the rest ornamental. In Britain, they flower in May and June, and ripen their cones in the spring of the following year. All the species bear seeds at a comparatively early age; and all of them may be readily propagated by cuttings taken off in the spring, according to Dumont De Courset; or in autumn, according to the practice of British gardeners. All the species hitherto introduced are quite hardy in British gardens. The genus, taking it altogether, is so truly natural, that, without any great violence, all the different kinds of which it is composed might be reduced to three or four species.

Sect. i. *Leaves tetragonal, awl-shaped, scattered in Insertion.*
(D. Don.)

‡ 1. *A. EXCÉLSA* Dec. The lofty, or Norway, Spruce Fir.

Identification. Dec. Fl. Fr., 3; Potr. Dict. Encyc., 6 p. 518; N. Du'Ham., 6 p. 269.

Synonymes. A. communis Hort.; Abies Picea Mill. Dict., No. 2, Michx. N. Amer. Syl., 3 p. 179; A. foliis solitariis, &c., Lin. Hort. Cliff., 449, Fl. Succ., ed. 1., p. 879, Fl. Lapp., ed. 1., No. 347., Genl. Sib., 1. p. 175; Pinus Abies Lin. Sp. Pl., 1421., Syst., ed. Reich., 4. p. 177., Fl. Succ., No. 875., Lapp., No. 347., Huds. Angl., 424., Humt. Evet. Syl., p. 266., Fl. Dan., t. 193., Pall. Fl. Ross., 1. p. 6., Alton. Fl. Ped., 2. p. 180., Vill. Dauph., 3. p. 810., Att. Hort. Kew., 3. p. 371., Willd. Berol. Beaux., p. 221., Smith in Beech's Cyc., No. 20., Lamb. Pin., ed. 2., 1. t. 35., How Analt., p. 51.; P. Picea Du Roi Harbk., ed. Pott., 2. p. 156.; P. foliis solitariis, &c., Hall. Helv., No. 1656.; P. excelsa Lam. Fl. Fr., ed. 1., 2. p. 202.; common Spruce, Prussian Fir; faux Sapin, Epicea, Sapin-Pesse, Serente, Sapin gentil, Pinesse, Fr.; Laffe, in the Voages; gemeine rothe Tanne, Ger.



Engravings. Nov. Act. Ac. N. Cur., 3, App., t. 14. f. 5. 10., and t. 16. f. 1. 10.; Blackw., t. 198.; Fl. Dan., t. 193.; Pall. Fl. Ross., 1. t. 3. f. G.; Wood. Med. Bot., t. 208.; Lamb. Pin., ed. 2., 1. t. 35.; N. Du'Ham., 6. t. 80.; Michx. N. Amer. Syl., 3. t. 146.; our fig. 2212.; and the plates of this tree in our last Volume.

Spec. Char., &c. Leaves scattered, quadrangular. Cones cylindrical, terminal, pendent; scales naked, truncate at the summit, flat. Crest of the anthers rounded. (*Lois.*) Cone from 5 in. to 7 in. long, and from 1½ in. to 2 in. broad; scale from 1 in. to 1½ in. long, and from ½ in. to ¾ in. broad. Seed very small, scarcely ¼ in. long, and ⅛ in. broad; with the wing, ¾ in. long, and ¼ in. broad. Cotyledons 7 to 9. Indigenous to the north of Europe, more particularly to Norway; and in cultivation in Britain since 1548.

Varieties.

- † *A. e. 1 communis.* *The common Spruce, or White Fir of Norway.*—The foliage is shorter, more slender, and lighter-coloured, than in the following form; though the difference may be in part owing to soil and situation. In Norway, as we are informed by Mr. White, the inhabitants make a distinction between the white and the red spruce: the former grows on light poor soils, and in elevated situations, and has a lighter foliage, and white wood; the latter grows in more substantial soils, in the valleys, and has a darker stronger foliage, and red wood, which is more resinous, and of much greater strength and durability.
- ‡ *A. e. 2 nigra.* *The black-leaved Spruce, or Red Fir of Norway.*—There is a tree in Studley Park, known there as the black spruce, of which a portrait is given in our last Volume. In the foliage, it answers to the description given of the red fir of Norway; its leaves being very thick, strong, and dark-coloured; its bark red; and its cones longer than those of the common spruce. The leaves, in the specimen sent to us, are 1½ in. in length; and the cones from 5½ in. to 6 in. long, and from 1½ in. to 1¾ in. broad. The scales (see *fig. 2213.*) are much more pointed than those of the common spruce, and longer. The tree at Studley is 121 ft. high; and, from its dense mass of dark foliage, it is considered a much finer tree than the common spruce.
- ‡ *A. e. 3 carpatica; A. carpatica Hort. and Loud Hort. Brit. The Carpathian Spruce.*—This variet has vigorous shoots, and foliage as dense and long as that of the preceding, but lighter. There is a tree at Dropmore, which in 1837, after being five or six years planted, was nearly 6 ft. high.
- ‡ *A. e. 4 pendula; A. communis pendula Booth; Pinus Abies pendula Lodd. Cat., ed. 1836. The pendulous, or weeping, branched Norway Spruce.*—This is distinguished from the species by the drooping habit of its branches; and also by the darker glossy green colour, and greater length, of its leaves. There is a plant in the Hackney arboretum 5 ft. high, the shoots of which are somewhat pendulous.
- ‡ *A. e. 5 foliis variegatis, P. A. foliis variegatis Lodd. Cat.,* has the leaves blotched with yellow, and forms a more compact dwarf-growing tree than the species. There is a plant in the Horticultural Society's Garden, 8 years planted, which is 7 ft. high.
- *A. e. 6 Clanbrasiliana; P. Clanbrasiliana Lodd. Cat., ed. 1837; is a low, compact, round bush, seldom seen higher than 3 ft. or 4 ft., and never, that we have heard of, producing either male or female blossoms. The annual shoots are from 1 in. to 3 in. or 4 in. in length; the leaves from ½ in. to ¾ in. long; and their colour is lighter than that of the species. The original plant is said to have been found on the estate of Moira, near Belfast, probably about the end of the last century; and to have been first introduced into Great Britain by Lord Clanbrasil; whence the specific name. The largest plant that we know of in the neighbourhood of London is at Cashibury, near Watford; where, in 1837, it was 3 ft. 6 in. high, having been 30 years*



221

planted; at Kenwood, Hampstead, it is 3 ft. high, after being 8 years planted; at Dropmore, it is 2 ft. 6 in. high; and in the Horticultural Society's Garden, after being 10 years planted, it is 3 ft. high. At Cranmore, near Belfast, it is 3 ft. high; diameter of the stem 2 in., and of the head 3 ft. It appears to us very doubtful whether such a stunted variety as this was ever found in a bed of seedlings: we think it much more probable that it is a continuation by cuttings of one of those bird-nest-like monstrosities that are occasionally found on all trees, and which are to be met with on several trees of the common spruce at Pain's Hill, and various other places. *A. e. Clanbrasiliana*, like the other varieties of the spruce fir, is readily propagated by cuttings, and makes a beautiful little fir for growing in a pot.

- *A. e. 7 Clanbrasiliana stricta*.—This variety was found in the park at Florence Court, by Mr. Young, gardener there, who sent us a drawing of the bush, and a specimen, in 1834. The bush has a clear stem of about 1 ft. in height; the head is of a narrow ovate conical form; and the shoots are of upright rapid growth; forming, Mr. Young observes, a very beautiful shrub for a lawn. Plants of it have been sent, by Mr. Young, to Mr. Knight of the Exotic Nursery, King's Road, and to Messrs. Smith, nurserymen, Ayr.
- *A. e. 8 pygmaea*, *A. nana* in the Horticultural Society's Garden, *A. elegans Smith of Ayr*, is said to be a dwarfer plant than *A. e. Clanbrasiliana*. A specimen in the Horticultural Society's Garden, 2 years planted, was, in 1837, 6 in. high.
- *A. e. 9 tenuifolia*, *A. tenuifolia Smith of Ayr*, has very slender leaves and shoots. A plant in the Hackney arboretum is 1 ft. high.
- *A. e. 10 gigantea*, *A. gigantea Smith of Ayr*.—There is a plant at Messrs. Loddiges's 1 ft. high, with leaves rather larger and stronger than those of the species.
- *A. e. 11 monstrosa*, *A. monstrosa Hort.*, has the shoots and leaves thicker than those of the species, and is said never to make any lateral branches. The plant in the Horticultural Society's Garden, after having been 12 years planted, consists of a single, upright, unnatural-looking, thickened shoot, 3 ft. in length, and densely covered with leaves.

Other Varieties. Bosc mentions a variety which was cultivated in the royal nurseries at Paris, and had been sent thither from the Vosges. It had the leaves flatter and more pointed than the common spruce, and different cones. Bosc says that this kind might, perhaps, form a distinct species; but that the plant was torn up when the royal nursery in which it grew was destroyed, and he had neglected previously to describe it. Hayes speaks of a seminal variety of the spruce, which has been denominated the long-coned Cornish fir, the cones being frequently nearly 1 ft. long; and of which, in the year 1790, there was a fine tree in the park of Avondale, in the county of Wicklow. (*Pract. Treat.*, p. 165.) Linnæus has five varieties in his *Flora Suecica*; but, as we are not aware of their having been propagated in British nurseries, we have not enumerated them. According to Gærtner, the species is exhibited in two forms, called the white and the red Norway spruce; one with pale, and the other with deep-coloured, cones; but the timber of both is white. Although these distinctions are not known in British gardens, we have thought it right to direct attention to them.

Description. The Norway spruce fir is the loftiest of European trees, attaining the height of from 125 ft. to 150 ft., or even, in some cases, 180 ft.; with a very straight upright trunk, from 2 ft. to 6 ft. in diameter; and widely extending branches, which spread out regularly on every side, so as to form a cone-like, or pyramidal shape, terminating in a straight arrow-

like leading shoot. The branches, in young trees, are disposed in regular whorls from the base to the summit; but in old trees the lower branches drop off, and the tree terminates in a pyramid of open angular branches, so that the regular whorls only occupy the middle portion of the tree. In young trees, the branches are nearly horizontal; but in old trees they droop gracefully at their extremities; and this pendulous disposition of the branches, joined to the dark sombre green of the leaves, gives to the whole tree somewhat of a gloomy or melancholy aspect. (See *fig. 2214.*, to a scale of 24 ft. to 1 in.) Between the regular whorls of branches, a few small abortive shoots appear occasionally. The bark of the trunk is rather thin, warty, and of a reddish brown, becoming wrinkled and scaly on old trees.

The roots are spreading, without a taproot, and with numerous fibres. The leaves are solitary, of a dark grassy green, generally under 1 in. in length, curved or bent, sharp-pointed, very straight and stiff, and more crowded together laterally than on the upper and under sides of the branchlets. The male catkins are numerous, solitary, in pairs, or a few together; from $\frac{1}{2}$ in. to 1 in. in length, on long peduncles; cylindrical, generally curved, of a yellowish colour, tipped with red; resembling at first a half-ripe strawberry, but gradually lengthening and becoming looser; and, when ripe, discharging a great quantity of yellow pollen from the anthers. The female catkins are produced at the extremities of the branches; and the cones, as they ripen, become pendent.

When in flower, the catkins are red or purplish, and pointed; but they soon take the form of a cone, or, rather, pointed cylinder; their colour then becomes greenish, and this changes, as they ripen, into a rich reddish brown. In different soils and situations, the colour of the female catkins, when in flower, varies from a dark red or purple to a pale red or yellow, or even to a greenish hue. The ripe cones are from 5 in. to 7 in. in length, and from $1\frac{1}{2}$ in. to 2 in. broad. The scales are rhomboidal, slightly incurved, and rugged or toothed at the tip, with two seeds in each scale. The seeds are very small, and resemble those of *P. sylvestris*; but are sharper-pointed, of a deep reddish brown, and rougher to the touch. In Germany, according to Hartig, they are frequently used for adulterating those of *P. sylvestris*, as they are obtained from their cones with scarcely any trouble; while those of *P. sylvestris* require considerable time and labour, and very frequently the employment of a



kiln, to extricate them. The wings of the seeds are oval, and pale brown; forming at the base a kind of spoon, in which one of the sides of the seed is enclosed, while the other is exposed to view. The seed does not escape immediately that the cone is ripe, but requires heat and drying winds to open the scales. This generally takes place between the months of February and May of the second year. The cones have each eight rows of scales in a spiral direction from the base to the summit; each row has from 20 to 23 scales, in each of which there are two seeds; and, consequently, an ordinary-sized cone contains from 320 to 368 seeds. The rate of growth in the spruce is nearly as great as that of the Scotch pine. For three or four years, at first, it does not average a growth of more than from 6 in. to 8 in. a year; but, after the plants are 3 ft. high, and till they attain the height of 50 ft., the rate of growth is from 2 ft. to 3 ft. a year, in favourable soils. In 10 years from the seed, the plants will attain the height of 12 ft. or 15 ft. in the climate of London; and, in 50 years, the height of from 90 ft. to 100 ft. The tallest specimens that we know of in the neighbourhood of London are at Syon, where it is drawn up among other trees, with a slender trunk, to nearly 100 ft. in height; but the most vigorous specimens are at Whitton, and they are from 85 ft. to 90 ft. high, with trunks from 2 ft. to 2 ft. 6 in. in diameter. The largest in England, that we have had any account of, is a tree at Studley, of which a portrait by H. W. Jukes, Esq., is given in our last Volume, and which is 132 ft. high, with a trunk 6 ft. 5 in. in diameter, regularly clothed with branches from the base to the summit. This tree is said to have been planted by Eugene Aram, who was steward of the Studley estate, about the middle of the last century. This spruce stands in the pleasure-grounds, near one of the cascades. We remarked its great height and fine appearance when we visited Studley, in 1806; and Mr. Jukes informs us that it is still in a state of vigorous growth, and adding to its height yearly. The lower branches form an ample canopy, beneath which a person may stand, and look up close to the bole of the tree to its very summit; the insertions of the branches being naked, the trunk perfectly straight, and the remainder of the branches being densely clothed with leaves, and forming a thick casing which excludes the light, and acts on the vision of a spectator below like the tube of a telescope. The duration of the tree in its native habitats is considered to be from 100 to 150 years. The trunk seldom, if ever, attains so great a thickness as that of *P. sylvestris*; but it is uniformly straighter; and the wood is whiter, more elastic, less resinous, and consequently lighter, than the timber of that tree.

From the pendent habit of the lower branches of the spruce, some curious anomalies are occasionally found in its habit of growth. The shoots next the ground, when they have attained a considerable length, naturally rest on the soil at their extremities; and the soil being kept moist by the shade of the branches, these often root into it; and the points of their shoots taking a vertical direction, a series of new trees are formed in a circle round the old tree. Some of the most remarkable examples of this kind that we are aware of are to be found at the Whim, an estate formerly belonging to the Duke of Argyll whose name, as an arboriculturist, has been so frequently mentioned in this work. An account of these spruces has been given in the *Gardener's Magazine*, by Mr. James M'Nab, of the Experimental Garden, Edinburgh, from which the following is an extract:—"The Whim is situated on the high grounds bordering the Pentland range of hills, 14 miles south-west of Edinburgh. The soil is chiefly composed of brown moss or bog earth, which is deep and spongy; the subsoil is various, but is chiefly a retentive whitish clay. A large proportion of this property was planted with the Norway spruce and a few black spruces, by the Duke of Argyll, soon after 1730. Nearly all the fine old specimens of spruces and other trees on this estate were cut down about 1810; but there are still some spruce firs, about 60 ft. high.

The girth of the largest common spruce on the estate is 5 ft. 10 in. at the surface of the ground; and that of the largest black spruce is 5 ft. 1 in. The peculiarities of growth which we have mentioned are shown in several specimens in different parts of the property; the most fantastic of which is one growing in the centre of a piece of elevated mossy ground, about an acre in extent, and within the boundary of the kitchen-garden wall, called the Wilderness. This tree has received the appellation of the Travelling Fir, on account of its branches having taken root wherever they have



come in contact with the soil. In this specimen (*fig. 2215.*, to a scale of 1 in. to 12 ft.), many natural layers from the trunk, and from the primary substems, have taken root, so as to form a double series of young trees, in two concentric circles round the parent trunk. The depth of the peat soil where this remarkable spruce grows is about 14 ft. That portion of the branch which is between the trunk of the original tree and the part where it roots into the ground, and which is sometimes several feet in length, rarely increases in diameter after its extremity has rooted (as shown in *fig. 2216.*, to a scale of 2 in. to 4 ft.). If these horizontal branches do increase in diameter, it is in a very slight degree; as some branches proceeding both from the main trunk and from primary substems, in the first concentric circle of young trees formed by them, vary from 2 ft. to 6 ft. in length, and are only from 1½ in. to 2 in. in diameter; while their extremities, which have rooted in the ground, and assumed the appearance of stems, vary from 6 in. to 2 ft. in circumference. The branches proceeding from the primary substems have also branches, equally healthy with themselves, proceeding from them, and with every appearance of their producing others; which, if allowed room, may, in course of time, cover the whole Wilderness. That portion of the main stem, or trunk of the parent tree, which remains above the surface of the soil, is little more than 4 ft. high before upright branches are produced; and it is 7 ft. in its greatest circumference. These upright branches, or rather limbs, are from 30 ft. to 35 ft. in height. The primary substems, which constitute the inner concentric circle of young trees, vary from 8 ft. to 25 ft. in height; and the secondary substems, which form the trees of the outer circle, are from 4 ft. to 10 ft. high. There are upwards of thirty rooted stems surrounding the mother tree; and 30 ft. is the greatest diameter of the space covered by stoloniferous branches; though in one case a secondary layer has reached as far as 18 ft. from the main trunk. The other specimens of this kind of tree were far inferior in size to the one now described; perhaps owing to the cattle browsing the side shoots, and destroying the tops of the young offspring;

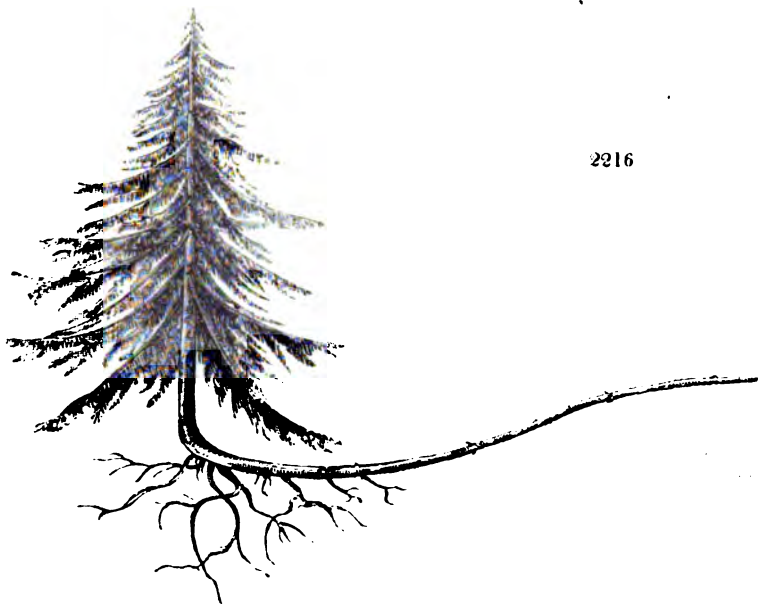

2216

whereas no cattle could enter the Wilderness to injure the spruce growing there. Besides the tree mentioned, other anomalies, equally interesting,

occur in two specimens, also of Norway spruce, which were blown down a great many years ago. The gardener, Mr. Young, has been at the Whim 15 years; and, during that period, no difference, he says, has been observable on the horizontal portions; but he knows considerable alteration in the upright stems, both as regards their circumference and height. One of these is called the Man-of-War Spruce. (*Fig. 2217.*, to a scale of 1 in. to 12 ft.) It has four stems, differing in height and distance from each other, as represented in the figure; the tallest being 34 ft. in height from the ground. At first sight, this tree seems to derive its principal nourishment from the lower portion of the root, at the extremity of the fallen stem: such, however, is not the case; for, on digging beside the horizontal trunk, several strong roots were found to have proceeded from the under portion of it, and these roots spread out many feet, at a few inches under the surface. In the other specimens (*fig. 2218.*, to a scale of 1 in. to 12 ft.), roots were seen protruding above ground, from the side of the horizontal stem; and, when examined by digging, the under surface was also found to have produced

2217



roots. In both examples, the original tops had decayed close to the uppermost arborescent branch; no doubt, in consequence of their not being able to turn upright: notwithstanding, however, the extremities of both have a tendency towards the upright position." (*Gard. Mag.*, vol. xiii. p. 249.)

Geography. The common spruce is indigenous to the hills and mountains of Europe and Asia, in places where the surface of the soil is moist, and the atmosphere cold and humid. It is most common in Norway, Sweden, Lapland, Denmark, and throughout the north of Germany. It is found on mountains in France, on the Alps, the Pyrenees, in the Vosges, in Burgundy, on the Jura, in Switzerland, and in Belgium. According to Pallas, it abounds in the north of Russia, and in Siberia; occupying cold, marshy, and springy places, and the valleys between mountains. Beyond the Lena, and in Kamtschatka, it is wanting; but it frequently occurs in the Kurile Isles. In the north of Russia and Siberia, it reaches to the arctic circle, and in some places beyond it; and in the north of Sweden and Lapland, as far as N. lat. 69°. It grows on the Swedish mountains at the elevation of 2000 ft., where *P. sylvestris*, according to Dr. Agardh (*Gard. Mag.*, vol. xii. p. 63.), is found principally in the plains. On the Lapland mountains, it grows at the height of 1000 ft. The spruce, in Norway, according to Schouw, extends to N. lat. 70°, and there grows at an elevation of 750 ft. In the south of Norway, it grows at the height of 3000 ft. The order of hardiness of the Scandinavian trees, according to Schouw, is: 1. the birch, which grows nearest the summits of the mountains; 2. the spruce fir; and, 3. the Scotch pine. The superior hardiness of the spruce to any other trees of the pine and fir tribe is thus established beyond a doubt. (See *Gard. Mag.*, vol. xii. p. 60.) The soil in which the spruce fir is generally found differs from that in which the Scotch pine abounds, in being softer and moister on the surface. Among dry rocks and stones, where the Scotch pine would flourish, the spruce fir will scarcely grow. The spruce fir, on the Alps of Switzerland, is frequently found above 150 ft. in height, with trunks from 4 ft. to 5 ft. in diameter, growing in moist soil in mountain valleys; and the timber of these trees is hard, tough, and very durable. The finest forests of this tree which we have seen are on the southern shores of the Baltic, between Memel and Königsberg, where the surface consists of a thin stratum of black peaty soil, incumbent on a bed of sand, and the whole of which is under water a great part of every winter. We have also seen the tree making a fine appearance on rocky banks in different parts of Sweden; but scarcely anywhere in that country is it to be found in situations so grand and picturesque as it is in Norway.

In the year 1817, and subsequently, a great many views in Norway were taken by James White, Esq., all of which he has kindly lent to us; and, from these we have made a selection to show the effect of the spruce fir, the Scotch pine, and, as connected with them, the common birch, in landscape scenery.

Fig. 2219. is a view of the Pass of Kroglevin, on the road to Ringerike,





near the Lake of Tiri Fiord, showing the effect of the spruce fir and the Scotch pine, on rocky precipices. The lake seen in the middle distance is Tiri Fiord.

Fig. 2220. is a view of a lake, and the surrounding hills and mountains, near Wasbotten, between the towns of Porsgrund and Laurwig, showing the spruce fir, together with some groups and masses of Scotch pine on mountain scenery.

Fig. 2221. is a view on the road from Porsgrund to Laurwig, not far from the town of Porsgrund, which shows the effect of the spruce fir on low hills and in bottoms.

Fig. 2222. is a view of Illoe Fors, near Schion, showing an extensive forest of Scotch pine on an extent of table land, with groups of the spruce, as contrasted with those of the birch; and showing the fine effect of the latter tree when standing singly, or in small loose groups. In this respect, indeed, the birch differs from most other trees, at no period of its growth having a picturesque effect in masses.

History. Pliny frequently mentions the spruce fir, which he calls picea (whence the French names *E'picea* and *Sapin-Pesse*), and which, he says, produced tears of resin that could scarcely be distinguished from incense. He also mentions its use in funeral ceremonies, on which occasions a branch was placed at door of the house of the deceased; and informs us that it was used when green for the funeral pile.

Though the spruce fir is generally allowed not to be a native of Britain, it appears to have been introduced at a very early period, as Turner includes it in his *Names of Herbes*, published in 1548; and both Gerard and Parkinson not only give very good engravings of it, but speak of its being found in great quantities in different parts of the island. The early British writers on trees, however, appear to have often confounded the Scotch pine with the spruce fir; and it is remarkable, that neither of the above-mentioned writers mentions the Scotch pine at all, though it is probably the tree Parkinson means, when he speaks of the "firre tree" growing wild in Scotland. The name of the fir tree, according to Gerard, was originally fire tree, in allusion to the use of the wood for torches and fuel; and it was also called the mast tree, and the deale tree. The spruce fir has always been considered, in Britain, as an ornamental tree; and, from the time of Miller, it has been introduced as such in parks and pleasure-ground scenery. About the end of the last century, and in the beginning of the present one, it was recommended by Adam, Sang, and others, in Scotland, and by Pontey in England, as well adapted for sheltering other trees; but it has never been planted in immense masses in Britain, as a timber tree, like the Scotch pine, though it has been so in Germany; and, from the various uses to which it may be applied even in a young state, it well deserves to be so in every country where it will thrive. The timber, which is called, in Norway, spruce pine, has been for an unknown period imported from that country into Britain, chiefly in the form of entire trunks, which are used for scaffolding-poles, spars, oars, and masts for small craft; but partly, also, sawn into planks or deals, known in commerce as white deal, white Baltic deal, and white Christiania deal; the red deal being, for the most part, the timber of *P. syl-*



2220



2221



vétris; though, as before stated, p. 2294., the wood of the spruce is red, when the tree is grown in certain soils and situations. The poles, spars, and oars are the thinnings of the Norwegian woods; and the deals and planks are made from the larger trees, which are left. The slenderest poles are taken from the largest and oldest woods, and are called seedlings: they are always found where the wood is most dense, and very often close by the side of a large tree. They grow very tall and slender, wholly without branches, except at the summit, and, though often only a few inches in diameter, are of great age. Some curious information on this subject, communicated by a Norwegian woodman, will be found in Montearth's *Forester's Guide*, from p. 226. to p. 232.

Poetical Allusions. According to some, the spruce fir was dedicated to Diana. Virgil speaks of it as being used in the funeral ceremonies of Misenus:—

“ Procumbunt piceæ.” *Æn.*, vi. 180.

He also says:—

“ Lucus in arce fuit summa, . . .
Nigranti picea, trabibusque obscurus acernis.” *Æn.*, ix. 87.

A grove waved on the summit of the hill,
Dark with black picea, and the lofty maple.

In the *Georgics* (lib. ii. 257.), Virgil speaks of the spruce fir as one of the indications of a cold soil.

The British poets so often mention the Scotch pine under the name of fir, which name they also apply to the spruce fir, that it is sometimes difficult to know which of these trees is meant; the following quotations, however, appear to belong to the spruce:—

“ Here spiry firs extend their lengthen'd ranks,
There violets blossom on the sunny banks.”

FAWKES'S *Bramham Park*.

Spenser speaks of it as “the fir that weepeth still;” and Fairfax terms it “the weeping fir;” both evidently alluding to the pendulous disposition of the branches. Prior, also, says:—

“ There towering firs in conic forms arise,
And with a pointed spear divide the skies.”

Properties and Uses. The wood of the spruce fir is light, elastic, and varying in durability according to the soil on which it has grown. Its colour is either a reddish or a yellowish white, and it is much less resinous than the wood of *P. sylvestris*. According to Hartig, it weighs 64 lb. 11 oz. per cubic foot when green, 49 lb. 5 oz. when half-dry, and 35 lb. 2 oz. when quite dry; and it shrinks in bulk one seventieth part in drying. The value of the wood for fuel is to that of the beech as 1079 is to 1540; and its charcoal is to that of the beech as 1176 is to 1500. Both as fuel and charcoal, the spruce fir is superior to the silver fir. As fuel, it is to the silver fir as 1211 to 1079; and as charcoal, as 1176 to 1127. The ashes furnish potash; and the trunk produces an immense quantity of resin, from which Burgundy pitch is made. The resin is obtained by incisions made in the bark, when it oozes out between that and the soft wood; and the mode of procuring and manufacturing it will be detailed hereafter. The bark may be used for tanning; and the buds and young shoots for making spruce beer, the details respecting which will be given under the head of *A. nigra*. The cones, boiled in whey, are considered good in cases of scurvy. The principal use to which the wood is applied is, for scaffolding-poles, ladders, spars, oars, and masts to small vessels; for which purposes, the greater proportion of the importations of spruce fir timber from Norway are in the form of entire trunks, often with the bark on, from 30 ft. to 60 ft. in length, and not more than 6 in. or 8 in. in diameter at the thickest end. The planks and deals are used for flooring rooms, and by musical instrument makers and carvers; they are also used by cabinet-makers for lining furniture, and for packing-boxes, and many similar purposes. The wood, being fine-grained, takes a high polish, and does well for gilding on; and it will take a black stain as well as the wood of the pear tree. In carving, the grain is remarkably easy to work, taking the tool every way. No wood glues better; and hence its great use for lining furniture, and making musical instruments. The young trees, especially when the bark is kept on, are found to be more durable than young trees of any other species of pine or fir, with the single exception of the larch; and for this reason they are admirably adapted for fencing, for forming roofs to agricultural buildings, and for a variety of country purposes. The durability of young trees of the spruce fir was first pointed out by Pontey in his *Profitable Planter*; and the circumstance which led him to discover it was, the sound state in which he found the dead branches in spruce fir plantations, which, though probably some of them had been dead more than twenty years, he uniformly found not only undecayed, but tough. This agrees with an observation of Mitchell, that the lateral branches of both the silver fir and the spruce fir are so full of turpentine, as to be as red as brick, and 4 lb. per foot heavier than oak. On further examination, Pontey discovered that young trees, which had been employed as beams in buildings, were perfectly sound at the end of 24 years; the bark, which had been left on, being also perfectly sound. There are but few spruce fir trees in Britain old enough to produce timber of large dimensions; but some of the older trees cut down at Blair, on the estate of the Duke of Athol, have been used as spars and topmasts, and found equal in quality to those imported from Norway. The value of the bark for tanning is nearly equal to that of the birch and the larch, quite equal to that of the silver fir; and much stronger than that of the Scotch pine. In Sweden, and also (according to Kaesthofer) in Switzerland, the young shoots form a winter food for cattle and sheep. The inhabitants of Finmark mix the points of the shoots with the oats given to their horses; and the Laplanders eat an excrescence about the size of a strawberry, which they collect from the extremity of the branches, where it is produced by the puncture of insects. The floors of rooms in Norway and Sweden, we are informed by Mary Wolstonecroft, and also by Samuel Laing, Esq., (the author of *Journal of a Residence in Norway during the Years 1834-35-36*), are, at least once a week, strewed over with the green tops of the fir or juniper; which, on a white well-scoured deal floor, have a lively and pretty effect, and prevent the mud on the shoes from adhering to and soiling the wood, giving out at the same time,

when trodden on, a refreshing odour; the more necessary in countries where the rooms being heated by stoves, for the sake of saving fuel, are badly ventilated. At funerals, the road into the churchyard and to the grave is strewed with these green sprigs; the gathering and selling of which is a sort of trade for poor old people about the town. In both Sweden and Norway, the inner bark is made into baskets; and the canoes, which are made of the timber of the large trees, and which are so light, as Acerbi informs us, as to be carried on a man's shoulders when a rapid or cascade interrupts the navigation, have their planks fastened together with strings or cords made of the roots, so that not a single nail is used in their construction. The long and slender roots are made use of to form this kind of strings; and they are rendered flexible by splitting them down the middle, and by boiling them for two or three hours in water mixed with alkali and sea salt. After this, they are dried and twisted into cordage, which is used as a substitute for hemp, both for naval and agricultural purposes. In Britain, the frond-like branches form an excellent protection to the blossoms of fruit trees on walls; being tucked in among the shoots of the fruit trees, when the blossom buds of the latter are beginning to expand, and left in that position till they have shed their leaves; by which time the fruit is set, and requires no farther protection. Spruce fir branches are also used for sticking early peas, to which they form a secure protection from spring frosts; and they might be used with excellent effect for protecting half-hardy plants, whether against walls or in the open garden.

The Spruce Fir is one of the best Nurses for other trees, not only from its dense mass of foliage, which may be considered as a reservoir of heat, but because, from its conical form, and its being abundantly furnished with branches on the surface of the ground, it acts as a non-conductor, and keeps the soil from cold and drought; and, while it protects the plant to be sheltered from high winds, it admits the top of that plant to the free enjoyment of light and air. From the great abundance of resin in the leaves and bark, the tree is considered a powerful non-conductor; and it is said that the snow that falls on its branches melts much faster than that which falls on any other tree, which is another argument in its favour as a nurse plant. William Adam, Esq., of Blair, in Kinross-shire, a planter of great experience, gave the following opinion as to the comparative merits of the larch, the spruce, and the silver fir, in 1794: — "The larch being deciduous, is not a good nurse; and, from its quick growth, it is probable that it is a great robber of the nourishment of other trees. From my own experience, I have no hesitation in saying that the spruce is to be preferred beyond all the other trees as a nurse. I have thousands of instances of oaks and elms growing up uninjured in the bosom of spruces. The fact is most important, and reason at the same time supports it. Deciduous trees send their roots downwards, particularly the oak: the spruce spreads its roots close under the surface; and their nourishment is drawn from different sources. The larger the oak grows, the more it derives its nourishment from the subsoil, and, consequently, the less its roots interpose with those of the spruce. This last rises, in a regular and very pointed cone, so that it leaves full space for the spreading top of the oak. The spruce is thickly clothed with leaves, and its branches are of a strong unpliant nature; consequently, it gives much protection, and does little injury to its neighbour; and, as it is very much feathered and bushy at the root, it protects the forest tree from being wind-waved. The larch, on the contrary, is naked of leaves during the worst of the season; and, from its boughs being thin and pliant, it lashes the neighbouring trees unmercifully, and it is in a condition, from its nakedness, to make every lash be felt just at the time when its neighbours begin to spring. It has also no peculiar thickness at the bottom, to protect the others from wind-waving. It might be supposed that the silver fir would make as good a nurse as the spruce; but, in point of fact, I have not observed that the forest tree grows so kindly with this fir as with the spruce; and it may be observed that the silver fir is not so thoroughly leaved as the spruce: the sides of the bough only are covered with leaves; and the tree itself is

not so well clothed, especially near the surface of the earth." (*Gen. Rep. Scot.*, vol. iv. p. 477.)

No tree is better adapted than the spruce fir for planting in narrow strips for *shelter or seclusion*; because, though the trees in the interior of the strip may become naked below, yet those on the outside will retain their branches from the ground upwards, and effectually prevent the eye from seeing through the screen. The tendency of the tree to preserve its lower branches renders it an excellent protection to game; and for this purpose, and also for the sake of its verdure during winter, when planted among deciduous trees, and cut down to within 5 ft. or 6 ft. of the ground, it affords a very good and very beautiful undergrowth. The tree bears the shears; and, as it is of rapid growth, it makes excellent hedges for shelter in nursery gardens. Such hedges are not unfrequent in Switzerland, and also in Carpathia, and in some parts of Baden and Bavaria. In 1814, there were spruce fir hedges in some gentlemen's grounds in the neighbourhood of Moscow, between 30 ft. and 40 ft. high. At the Whim, already mentioned, p. 2297., a spruce fir hedge (*fig. 2223.*)

was planted, in 1823, with plants 10 ft. high, put in 3 ft. apart; and, with the exception of three left to shoot up, for the purpose of being clipped into ornamental figures, the whole were cut down to 5 ft., and afterwards trimmed to the shape represented in the figure. The hedge was first cut on January 25., the year after planting; and, as the plants were found to sustain no injury, about the end of that month has been chosen for cutting it every year since. Every portion

of this hedge, Mr. M'Nab observes, "is beautiful and green; and the annual growths are very short, giving the surface of the hedge a fine healthy appearance." (*Gard. Mag.*, vol. xiii. p. 254.)

As an ornamental tree, all admirers of regularity and symmetry are partial to the spruce, unless we except the author of the *Planter's Kalendar*, who says that, next to the Lombardy poplar and the Scotch pine, it is the least ornamental of common trees; the meaning of the writer probably being, that it has less variety in itself. Gilpin is evidently no great admirer of the tree; but still he allows it to have its peculiar beauties. "The spruce fir," he says, "is generally esteemed a more elegant tree than the Scotch pine; and the reason, I suppose, is, because it often feathers to the ground, and grows in a more exact and regular shape: but this is a principal objection to it. It often wants both form and variety. We admire its floating foliage, in which it sometimes exceeds all other trees; but it is rather disagreeable to see a repetition of these feathery strata, beautiful as they are, reared tier above tier, in regular order, from the bottom of a tree to the top. Its perpendicular stem, also, which has seldom any lineal variety, makes the appearance of the tree still more formal. It is not always, however, that the spruce fir grows with so much regularity. Sometimes a lateral branch, here and there, taking the lead beyond the rest, breaks somewhat through

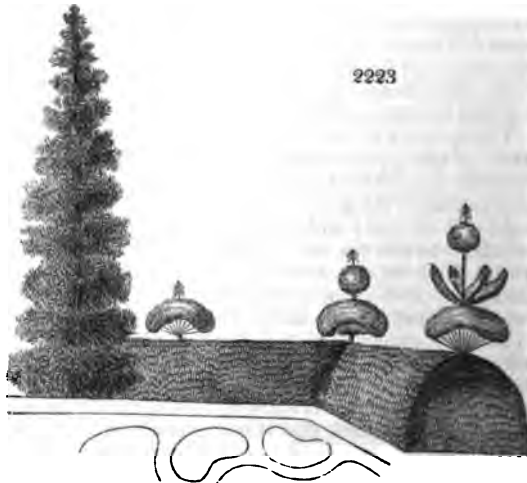

the order commonly observed, and forms a few chasms, which have a good effect. When this is the case, the spruce fir ranks among picturesque trees. Sometimes it has as good an effect, and in many circumstances a better, when the contrast appears still stronger; when the tree is shattered by some accident, has lost many of its branches, and is scathed and ragged. A feathery branch, here and there, among broken stumps has often an admirable effect; but it must arise from some particular situation. In all circumstances, however, the spruce fir appears best either as a single tree, or unmixed with any of its fellows; for neither it, nor any of the spear-headed race, will ever form a beautiful clump without the assistance of other trees." (*For. Scen.*, i. p. 93.) "Luxuriantly as the spruce fir grows with us in Britain," says Sir Thomas Dick Lauder, "we must crave for it the same justice we have demanded for the Scotch pine, and deprecate any rash judgment being formed, either on its external appearance, or on its timber, from any other than the specimens exhibited in its native forests; where individuals are to be found 150 ft. high, and with trunks 5 ft. in diameter. The spruce fir is the great tree of the Alps; and, so far as our opinion of its effect in landscape may go, we can only say that, with us, it is so mentally associated with the grandeur of Swiss scenery, that the sight of it never fails to touch chords in our bosom which awaken the most pleasing recollections. What can be more truly sublime than to behold, opposed to the intensely blue ether, the glazed white summits of Mont Blanc, or the Jungfrau, rising over the interminable forests of spruce firs which clothe the bases of the mountains; whilst some such gigantic specimens as those we have been noticing rise in groups among the rocks before us, many of them shivered, broken, and maimed by tempests, their dark forms opposed to all the brilliant prismatic hues of some immense gorgeous glacier, which nourishes in its vast bosom a mighty river, that is doomed to fertilise and to enrich whole kingdoms." (*Lauder's Gilpin*, i. p. 178.) Sir James Edward Smith observes that the long, sweeping, fan-like branches of the spruce, after broken down by loads of snow, and boisterous winds, have a grand effect in alpine landscapes, and have been well employed in the sublime compositions of Salvator Rosa and the German engravers.

The resinous Products of the Spruce Fir are of a different kind from those of most of the trees of the genus *Pinus*. The sap does not flow from the tree in the form of turpentine, but slowly oozes out from between the bark and the soft wood, hardening by exposure to the air. The principal product of this tree is the Burgundy pitch of the shops, which is the congealed sap melted, and clarified by boiling it in water. To collect it, the operator, in spring, before the sap is in motion, cuts out a strip of bark 3 ft. long, and 1 in. or 1½ in. wide, vertically from the south side of the tree, as deep as the soft wood, but without wounding it. This is done with an instrument made on purpose, resembling a knife, with a crooked blade at one end, and a flat blunt piece of iron at the other. The lower part of the incision, which is brought down to within 20 in. of the ground, is cut sloping, so as to prevent the rain water from lodging in the groove. As soon as the sap is in motion, the sides of this groove begin to fill with resinous matter, which, however, accumulates very slowly; and it is not till the month of July or August in the following year that the groove will be full; when the resin is scraped out with the hooked-bladed knife before mentioned, and put into a conical basket, or scuttle, made of bark, till wanted for manufacturing. In the spring of the next year, a thin slice of bark is cut off each side of the groove; and in the August of the year following, a second crop of resin is obtained; but this is much inferior to the first. As the process may be carried so far as to destroy the tree, the following rules have been laid down by Hartig for procuring the resin:— 1st, To choose the trees only from forests destined to furnish wood for fuel. 2dly, Not to begin to extract resin till within 10 or 12 years of the period when the trees are destined to be cut down; and

not to collect resin more than five or six times from each tree. 3dly, Not to scrape off the resin before the month of July or August of the year after that in which the groove has been made, or its edges fresh-pared, in order to give the resin time to harden, and the bark under it to heal sufficiently to prevent the rain from rotting the wood; and, 4thly, Not to make more than one groove at a time upon a tree if it be small, or two if it be large; and never to make the grooves more than 4 ft. in length or, more than 1 in. or $1\frac{1}{2}$ in. in width. Attempts have been made to show that resin may be procured from trees artificially, without seriously injuring them; and one author (M. Burgsdorf) asserts that, if the spruce fir has attained its full growth, all its resin may be extracted from it without injuring the quality of the wood for fuel or charcoal; while another (M. Malus) assures us that the timber of the tree may still be used even for the purposes of construction. Du Hamel, Hartig, and most other authors, however, are of a very different opinion; Hartig having found that carrying the process of extracting the resin to an extreme degree, not only renders the wood unfit for the purposes of construction, but even makes it almost useless for fuel. In Sweden, and on the southern shores of the Baltic, a similar opinion prevails; and the resin is there only collected from those trees which have been pruned; in which case it generally oozes out from the wound.

Mode of preparing the Burgundy Pitch. This pitch, or rather resin, is principally made in the Vosges. The slightest scar in the bark of the tree will be sufficient to make the resin ooze out; but it must be observed that it never flows to the ground like turpentine, but congeals as soon as it issues from the wound, and remains attached to the bark in tears or crystals, something like the gum of cherry trees. To procure the sap in abundance, it is necessary, as we have already observed, to take off a narrow strip of bark, which is done with the broad end of the instrument before mentioned, or with a small hatchet; great care being taken not to wound the wood. The resin from young trees is softer than that from old ones; but it is always dry enough to be put into bags, in which it is kept till a sufficient quantity is collected. To prepare the pitch, it is first necessary to melt the resin; and, for this purpose, caldrons are set in masonry, in such a manner that the fire only touches the bottom of the caldron; and the chimney is carried to such a height, or to such a distance, as to prevent all danger of the flame issuing from it being driven by the wind or other causes on the resin. A quantity of water is then put into the caldron so as to fill it 4 in. or 5 in. high; and into this the resin is put a little at a time, till the caldron is about four fifths full. A gentle fire is then lighted below, which is gradually augmented, till the water boils, and the resin is all melted. It must now be gently stirred; after which, the fire is withdrawn, and the resin is in a state for being purified. This is done by pouring the liquid from the caldron into a bag made of coarse linen, which has been previously wetted; filling it not more than two thirds, and afterwards putting it under a light press. The resin flows pure and clear into small casks made of fir wood; and in this state it is the yellow Burgundy pitch of commerce. The refuse left in the sack, being pressed a second time, yields a blacker resin, which is used for the same purposes as the colophony of the pine; and what remains, after this has been pressed out, is burned in order to make lampblack. In general, 100 lb. of resin, as collected from the tree, yields 50 lb. of Burgundy pitch, and 2 lb. of colophony. Trees grown on fertile soils are said to yield a greater proportion of resin than those grown on poor soils; and the pitch is said to be better when the resin has been collected in a hot dry summer, than in a cold and humid one. An essential oil is produced from the Burgundy pitch, by distillation; but it is very inferior to spirit of turpentine. A strong and vigorous spruce fir will yield, every second year, from 40 lb. to 50 lb. of congealed resin; and this may be collected for from 20 to 25 years, if no other value is set on the tree; but, if the collection of the sap be continued for this length of time, the tree becomes

rotten and decays, giving birth to myriads of insects, which seriously injure the surrounding trees. It is therefore better to cut the trees down after extracting the sap for 10 or 12 years, as before advised; because the wood may then probably be used for packing-boxes, &c., and, at any rate, will be good for fuel and charcoal.

Soil, Situation, Propagation, and Culture. All agree that the spruce fir requires a soil somewhat moist. Like all other firs, Sang observes, it will grow and thrive in soils of very different qualities; but it never attains large dimensions in shallow soils and exposed places. On dry soils, it invariably becomes stunted, produces a great number of cones at an early age, and soon dies. The check given to large trees by transplanting also throws them into bearing; by which means, even in the most suitable soils, the progress of the tree in making wood is much impeded. Hence, in the case of the spruce, as in all the other *Abiétinæ*, the great advantage of transplanting the tree when young. The spruce fir grows most luxuriantly in deep loams and low situations; or on acclivities with a north-east aspect, and a moist sandy soil; in which last situation, at Blair and other places in Scotland, it is found to produce timber as strong and durable as that imported from Norway. The mature cones may be gathered any time between November and April: they should be chosen from healthy vigorous trees, and exposed to the heat of the sun, placed in a warm room, or slightly dried on a kiln; after which, the seeds will drop out by merely shaking the cones, or gently thrashing them. Fifteen gallons of cones will produce 2 lb. of seeds with their wings, or 1 lb. 4 oz. without them. After being collected, the seeds may be kept three or four years, and will still preserve their vitality; but it is always safest to sow them immediately after taking them from the cones, or in the course of the following March or April. The seeds of the spruce fir, being nearly of the same size as those of the Scotch pine, may be treated in the nursery in a similar manner (see p. 2179.); but, as the plants, when they come up, are more prolific in fibrous roots, and less so in shoots and leaves, they may be kept in the nursery, by frequent transplanting, till they attain a much larger size. The most convenient time for planting them where they are finally to remain is after they have been two years in the seed-bed, and one year transplanted; and the operation should never be performed but in mild weather, and when the air is somewhat moist. Where the seeds are to be sown to grow up at once into a plantation, without transplanting, the same quantity may be used as in the case of the Scotch pine (see p. 2178.). In Germany, and in some parts of France, according to Baudrillart, the seeds of the common spruce are sown along with those of oats, rye, or barley, at the rate of from 2 quarts to 4 or 5 quarts per acre; and, after the crop of corn is removed, the ground is enclosed, and left to become a spruce fir wood. The same thing is practised with the Scotch pine, and various other forest trees. The first year from the seed, young plants of the spruce fir make very little progress, not producing more than eight or nine leaves, and not rising higher than from 1 in. to 2 in. The second year, they push from 2 in. to 4 in.; and the third year they put out lateral branches. The fourth and fifth years, the plants begin to grow fast, showing whorls of branches in the same manner as full-grown trees. The period of growth for the annual shoots, from this year, and ever afterwards, is from two to two and a half months; but the roots continue growing the whole summer. The eighth year, the length of the leading shoot will be from 2 ft. to 3 ft. Where the tree is grown principally for its branches, either as undergrowth for hedges, or as strips for shelter or seclusion, the plants ought to be placed 5 ft. or 6 ft. apart, and thinned out as soon as they touch each other; but, where they are planted in masses for the purpose of producing rods for stakes, or poles for hops, fencing, or spars, they may be planted from 3 ft. to 6 ft. apart every way, and not thinned till they are of such a length as to be sufficient for some useful purpose. Full-grown plantations of spruce firs should be thinned either by cutting out the smallest, where the

main object is to produce timber trees; or by cutting out the largest when fit for poles, if this be the main object. Very little pruning is required for the spruce fir, except in the case of large trees; when the lower branches may be cut off close to the stem, to the height of a fourth, or from that to a third, part of the height of the whole tree. When pruned, the branches ought to be cut off close to the stem, in order that the wound may heal over as speedily as possible. Hayes mentions a practice adopted by a gentleman in Ireland, of cutting off every other tier of branches, for the purpose of strengthening those which were left; and, by allowing the branches to hang down more freely, thus to increase the picturesque appearance of the tree. (*Pract. Treat.*, p. 166.) At whatever age the trees are cut down, the roots ought to be grubbed up, as they furnish a valuable material for fuel or charcoal. The season of felling, where the bark is to be kept on, should be mid-winter, when the sap is in its most dormant state: but, where the bark is wanted for tanning, May is preferable; because then the sap is in motion, and the bark easily separates from the wood.

Statistics. In the Environs of London. At Mount Grove, Hampstead, 18 years planted, it is 29 ft. high; at Syon, it is between 90 ft. and 100 ft. high; at Chiswick Villa, it is 60 ft. high; at Whitton, between 80 ft. and 90 ft. high.—South of London. In Somersetshire, at Kingsweston, it is 95 ft. high, with a trunk 3 ft. in diameter. In Surrey, at Bagshot Park, 16 years planted, it is 36 ft. high; at Claremont, it is 95 ft. high, the diameter of the trunk 2 ft., and of the head 36 ft. In Essex, at Cowdrey, it is 80 ft. high, with a trunk 3 ft. 9 in. in diameter. In Wiltshire, at Longest, 80 years planted, it is 99 ft. high, the diameter of the trunk 4 ft., and of the head 44 ft.—North of London. In Buckinghamshire, at Temple House, 40 years planted, it is 50 ft. high. In Essex, at Audley End, 61 years planted, it is 60 ft. high, the diameter of the trunk 2 ft. 6 in., and of the head 30 ft. In Hertfordshire, at Hatfield, 105 years old, it is 71 ft. high, the diameter of the trunk 2 ft. 6 in., and of the head 15 ft. In Hertfordshire, at Aldenham Abbey, 34 years planted, it is 65 ft. high. In Leicestershire, at Donnington, 38 years planted, it is 52 ft. high. In Norfolk, at Marton Hall, it is 87 ft. high, with a trunk 3 ft. 6 in. in diameter. In Shropshire, at Hardwicke Orange, 10 years planted, it is 22 ft. high; at Willey Park, 18 years planted, it is 40 ft. high, the diameter of the trunk 1 ft., and of the head 20 ft. In Staffordshire, at Trentham, it is 90 ft. high, the diameter of the trunk 3 ft. 4 in., and of the head 30 ft. In Suffolk, at Finborough Hall, 60 years planted, it is 100 ft. high, the diameter of the trunk 3 ft., and of the head 50 ft. In Worcestershire, at Hadzor House, 10 years planted, it is 20 ft. high. In Yorkshire, in Studley Park, the tree of which a figure is given in our last Volume, 132 ft. high.—In Scotland. In Ayrshire, at Kilkerran, 55 years planted, it is 95 ft. high, with a trunk 3 ft. 6 in. in diameter, and that of the head 30 ft. In Aberdeenshire, at Thainston, 54 years planted, it is 67 ft. high. In Argyllshire, at Toward Castle, 15 years planted, it is 30 ft. high. In Forfarshire, at Monboddoo, 28 years planted, it is 30 ft. high; at Courteachy Castle, 14 years planted, it is 27 ft. high; another, 50 years planted, is 55 ft. high. In Inverness-shire, at Coussa, 40 years planted, it is 60 ft. high. In Perthshire, at Invermay, it is 84 ft. high, the diameter of the trunk 5 ft. 9 in., and of the head 64 ft.; at Taymouth, it is 100 ft. high, the diameter of the trunk 4 ft., and of the head 51 ft. In Stirlingshire, at Sauchie, it is 96 ft. high, diameter of the trunk 2 ft. 6 in., and of the head 30 ft.; at Blair Drummond, 150 years old, it is 98 ft. high, the diameter of the trunk 2 ft. 6 in., and of the head 20 ft.—In Ireland. In Fermanagh, at Florence Court, 55 years planted, it is 70 ft. high, the diameter of the trunk 1 ft. 6 in., and of the head 60 ft.; at Castle Coole, it is 62 ft. high, the diameter of the trunk 2 ft. In Sligo, at Mackree Castle, it is 96 ft. high, the diameter of the trunk 2 ft. 8 in. In Tyrone, at Baron's Court, 60 years planted, it is 100 ft. high, the diameter of the trunk 2 ft. 6 in., and of the head 50 ft.—In Saxony, at Wörlitz, 60 years planted, it is 80 ft. high, the diameter of the trunk 4 ft., and of the head 40 ft.—In Cassel, at Wilhelmschnee, it is 60 years old, with a trunk 4 ft. in diameter.—In Bavaria, in the Botanic Garden at Munich, 24 years planted, it is 40 ft. high.—In Austria, at Vienna, in the University Botanic Garden, 30 years planted, it is 50 ft. high; at Brünn on the Leytha, 60 years planted, it is 100 ft. high.—In Prussia, near Berlin, at Sans Souci, 40 years planted, it is 60 ft. high.

Commercial Statistics. Price of seeds, in London, 3s. per lb.; and of plants, one year's seedlings, 1s. 6d. per thousand; three years' seedlings, 8s. per thousand; and transplanted plants, from 12 in. to 18 in. high, 25s. per thousand. At Bollwyller, single plants are 8 cents each; and at New York, from 50 cents to 1½ dollar, according to the size.

‡ 2. *A. ALBA Michx.* The white Spruce Fir.

Identification. Michx. Fl. Bor. Amer., 2. p. 207.; Arb., 1. p. 133.; N. Amer. Syl., 3. p. 182.; Poir. Dict. Encyc., 6. p. 521.; N. Du Ham., 6. p. 291.

Synonymes. *Pinus alba* *Mit. Hort. Kew.*, 3. p. 371., *Willd. Berol. Baumz.*, p. 221., *Lamb. Pin.*, ed. 2., 1. t. 36.; *P. laxa* *Ehrh. Beitr.*, 3. p. 24.; *P. canadensis* *Du Roi Herb. p. 124.*, *Wangh. Beyt.*, 5. t. 1.; *Abies Picea foliis*, &c., *Hort. Angl.*, 2. t. 1., *N. Du Ham. Arb.*, 1. p. 3.; *A. curvifolia* *Hort.*; single Spruce, *Amer.*; *Epinette blanche*, *Comeds*; *Sapinette blanche*, *Fr.*; *Engravings.* *Lamb. Pin.*, ed. 2., 1. t. 36.; *Wangh. Beyt.*, 5. t. 1. f. 2.; *Hort. Angl.*, 2. t. 1.; *N. Du Ham.*, t. 81. f. 2.; *Michx. N. Amer. Syl.*, 3. t. 148.; our *fig.* 2294.; and the plate of this tree in our last Volume.

Spec. Char., &c. Leaves somewhat glaucous, scattered round the branches, erect, quadrangular. Cones oblong-cylindrical, pendulous, lax; scales with entire margins. (*Michx.*) Cones from 1½ in. to 2½ in. long, and from ½ in. to ¾ in. broad; on the tree at Dropmore, 4 in. long. Seed very small;



with the wing, $\frac{3}{8}$ in. long, $\frac{2}{8}$ in. broad. Leaves $\frac{3}{8}$ in. long; on the tree at Dropmore, twice the length of those of *A. nigra*, very glaucous when they first come out. A tree, from 40 ft. to 50 ft. high, a native of North America. Introduced in 1700; flowering in May and June.

Variety.

† *A. a. 2 nana* Dickson of the Chester Nursery is a low-growing plant, apparently somewhat distinct. The specimen in the Horticultural Society's Garden, 10 years planted, is 3 ft. high.

Other Varieties. Loiseleur Deslongchamps states that, according to the specimens of *A. orientalis* which Tournefort brought from the Levant, this alleged species cannot be separated from *A. álba*. He therefore introduces *A. orientalis* *Tourn., Poir. Dict.*, vi. p. 508., and *Lamb. Pin.*, ed. 1., ii. t. 39., as a variety of *A. álba*. We have placed it at the end of this section, in small type, as not having been seen by us in a living state.

Description, &c. The general aspect of the white spruce is much lighter than that of any other species of the genus. It has a tapering trunk, which, according to Michaux, in America, rarely exceeds 50 ft. in height, and 1 ft. or 1 ft. 4 in. in diameter; and its branches form a regular pyramid. The bark is considerably lighter in colour than that of any other spruce; the leaves are also less numerous, longer, more pointed, at a more open angle with the branches, and of a pale bluish green. The male catkins are pendulous, on long footstalks, and of a brownish yellow. The female catkins are ovate and pendulous. When ripe, the cones are small, of a lengthened oval in shape, and a light brown colour; the scales are loose and thin, round or bluntly pointed, with entire edges. The seeds are minute, with a very small wing, and ripen a month earlier than those of the black spruce. When the tree is agitated with the wind, or when the cones are gently struck with a stick, the seeds drop out, and fall slowly to the ground with a tremulous fluttering motion, resembling a cloud of small pale brown moths. The wood is inferior in quality to that of any of the other spruces; and it "snaps more frequently in burning." The white spruce is a native of Canada, New Brunswick, and the district of Maine. It extends from the Lake St. John, in 48° or 49°, to about 70° n. lat.; but is much less common than the black spruce is in the same districts. Dr. Richardson, in his *Appendix to Captain Franklin's Tour to the North Pole*, mentions *A. álba* as the most northerly tree that came under his observation; and states that, on the Coppermine River, within 20 miles of the Arctic Sea, he found trees of it 20 ft. high. The wood is considered of little value; but the fibres of the roots, macerated in water, are very flexible and tough when deprived of their pellicle, split, and cleaned; and they are used, in Canada, to stitch together the canoes of birch bark (see p. 1709.), the seams of which are afterwards smeared over with a resin, improperly called gum, that distils from the tree. (*Michx.*, and *Gard. Mag.*, vol. vi. p. 406.) Mr. Lambert states that the bark is used in tanning, and the young sprigs for

spruce beer; but both these appear to be mistakes. Michaux and Pursh, indeed, both expressly assert that the branches are quite unfit for making beer; and Michaux adds that the leaves, when bruised, diffuse an unpleasant odour. It was introduced into England by Bishop Compton, in 1700. The rate of growth, in the climate of London, in sandy soil somewhat moist, is from 12 ft. to 15 ft. in 10 years. In 30 years, the tree will attain the height of from 30 ft. to 40 ft.; but in dry soils it seldom reaches either this age or height: indeed, all the American spruces may be considered, in England, as short-lived trees. The largest specimen that we know of in England is one at White Knights, where, in 1837, after being 40 years planted, it was 50 ft. high; one at Dropmore is 47 ft. high; and a plant in the Horticultural Society's Garden, 12 years planted, is 14 ft. high. The tree is very ornamental when its summit is richly laden with cones.

Statistics. In England. In Surrey, at Farnham Castle, 50 years old, it is 40 ft. high; at Bagshot Park, 16 years planted, it is 35 ft. high; at Deepdene, 9 years planted, it is 20 ft. high. In Oxfordshire, in the Oxford Botanic Garden, 40 years planted, it is 20 ft. high. In Staffordshire, at Trentham, it is 20 ft. high. — In Scotland. In Forfarshire, at Courtachy Castle, 14 years planted, it is 18 ft. high. In Berwickshire, at the Hirsell, 18 years planted, it is 23 ft. high. — In Ireland. At Dublin, in the Glasnevin Botanic Garden, 35 years planted, it is 20 ft. high. In Down, at Ballyleady, 60 years planted, it is 55 ft. high. In Galway, at Cool, it is 56 ft. high, the diameter of the trunk 2 ft. 6 in., and of the head 37 ft. — In France, near Paris, at Scéaux, 10 years planted, it is 24 ft. high. — In Hanover, at Harbecke, 10 years planted, it is 16 ft. high. — In Austria, near Vienna, at Brück on the Leytha, 50 years planted, it is 40 ft. high. — In Bavaria, at Munich, in the English Garden, 20 years planted, it is 18 ft. high. — In Prussia, at Sans Souci, near Berlin, 30 years planted, it is 40 ft. high.

Commercial Statistics. Price of seeds, in London, 4s. per lb.; of plants, two-years' seedlings, 10s. per thousand. At Bollwyller, plants are 1 franc each; and at New York, 50 cents.

‡ 3. *A. NIGRA* Ait. The black Spruce Fir.

Identification. Poir. Dict. Encyc., 6 p. 220; Michx. Arb., 1. p. 123; N. Amer. Syl., 3. p. 176; N. Du Ham., 6. p. 222.

Synonymes. Pinus nigra Ait. Hort. Kew., 3. p. 570. Willd. Berol. Botanz., p. 220. Lamb. Pin., ed. 2., 1. t. 37. De Bot. Harbk., ed. Pott., 2. p. 182; P. maritima Ehrh. Beyt., 3. p. 23; Abies maritima Wagh. Beyt., p. 75; double Spruce.

Engravings. Lamb. Pin., ed. 2., 1. t. 37.; Michx. N. Amer. Syl. 3., t. 147.; our fig. 2225; and the plate of this tree in our last Volume.

Spec. Char., &c. Leaves solitary, regularly disposed all round the branches; erect, very short, somewhat quadrangular. Cones ovate, pendulous; scales somewhat undulated; the apex of the scale crenulated or divided. (*Michx.*) Cones from 1½ in. to 1¾ in. long, and from ¾ in. to nearly 1 in. broad. Seed rather larger than that of *A. álba*, but the wing smaller. Leaves from ¼ in. to ⅝ in. long. A large tree, a native of North America. Introduced in 1700; flowering in May or June.

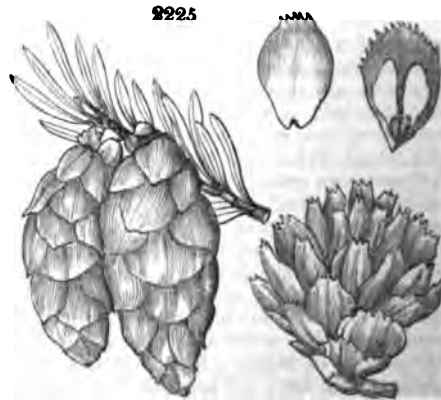

Varieties. The kind generally designated as *A. rubra*, *P. rubra* Lamb., is asserted by Michaux to be only a variety, or rather variation, of *A. nigra*, produced by the influence of the soil on the wood. "The inhabitants of the country, and mechanics who work in the woods," says Michaux, "take notice only of certain striking appearances in forest trees, such as the quality of the wood, its colour, and that of the bark; and, from ignorance of botanical characters, they give different names to the same tree, according to certain variations in these respects arising from local circumstances. To this cause must be attributed the popular distinction of red and black

spruce." (*N. Amer. Syl.*, iii. p. 178.) As the variety appears tolerably distinct in British gardens, as far as respects the colour of the cones, we have, for convenience' sake, given it as a species; though we entirely agree with Michaux in thinking it only a variety.

Description. A tall tree, attaining in America the height of 70 ft. or 80 ft. in the woods, though the trunk is seldom more than from 1 ft. 3 in. to 1 ft. 8 in. in diameter. The branches spread more in a horizontal than in a drooping direction, like those of the Norway spruce; and, consequently, the black spruce (notwithstanding the darkness of its foliage) has not the gloomy aspect of the European tree. The trunk is smooth, remarkably straight, and diminishes regularly from the base to the summit, which is terminated by an annual lance-like shoot, 1 ft. or 1 ft. 3 in. long. The bark is smooth and blackish. The leaves are of a dark sombre green: they are short, being scarcely $\frac{1}{2}$ in. long, thickly set, stiff, and are attached singly to the branches, which they cover all round. The male catkins are cylindrical, erect, and on peduncles; about 1 in. long; yellowish, with red-tipped anthers. The female catkins are oval, and at first erect, but soon become pendulous: they are purplish, and almost black, when young; but become, when ripe, of a dusky reddish brown. When full-grown, they are about $1\frac{1}{2}$ in. long, and $\frac{3}{4}$ in. in diameter at the middle. The scales are blunt, rounded, very thin, and, when ripe, rugged and torn on the margin, and sometimes half through the scale. The seeds are small, scarcely more than a line in length, with rather a small rigid wing. The rate of growth of *A. nigra* is more rapid than that of *A. álba* under similar circumstances. The finest specimens that we have seen in the neighbourhood of London are at Pain's Hill, near the Temple of Bacchus; where, in 1837, there were several trees between 60 ft. and 70 ft. high, laden with cones. The tree in the Horticultural Society's Garden, after being 12 years planted, was 20 ft. high. One at Dropmore, lately planted, was, in 1837, 10 ft. high, bearing abundance of cones. *A. nigra*, like *A. excélsa*, is liable to take root at the extremity of the branches, and form circles of trees round the parent plant. There is a remarkable specimen of this kind at Syon, of which *fig.* 2226. is a portrait to the scale of 1 in. to 12 ft. The entire mass, which consists of a centre tree, with a double circle of young trees, is 30 ft. high, and 30 ft. in diameter; and the trees of which it is composed bear abundance of cones. One is described by Mr. Gorrie, in the *Magazine of Natural History*, vol. ii. p. 173., as standing in the woods of Braco Castle, Perthshire; of which *fig.* 2227. is a portrait by Mr. Gorrie. This tree, in 1828, was about 40 years old, and its height about 40 ft. Mr. Gorrie adds that a natural seedling, which had sprung up not far from the mother tree, and was apparently about 12 years of age, was also, in its turn, already surrounded by a numerous and healthy progeny of young trees, proceeding from the extreme points of the branches.

Geography and History. According to Michaux, this tree is a native of the coldest regions of North America; but is most abundant in the countries



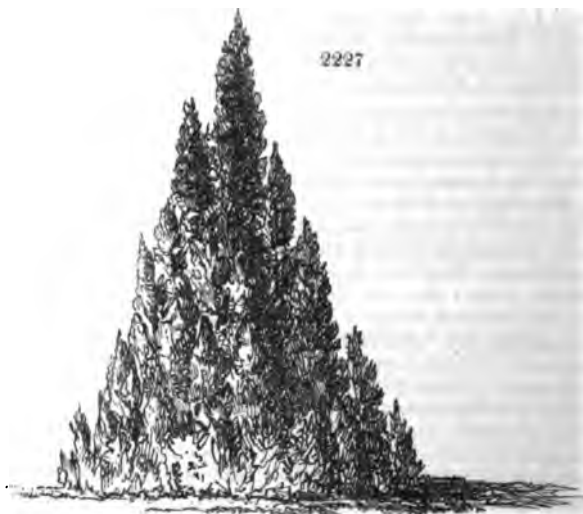

lying between 44° and 53° N. lat., and between 55° and 75° W. long.; viz. in Lower Canada, Newfoundland, New Brunswick, Nova Scotia, the district of Maine, Vermont, and the upper parts of New Hampshire, where it is so abundant, as to constitute a third part of the native forests. Farther south it is rarely seen, except in cold and humid situations on the top of the Alleghanies. "It is particularly remarked in a large swamp not far from Wilkesburg in Pennsylvania, and on the Black Mountain in South Carolina; which is one of the loftiest summits in the southern states, and is probably thus named from the melancholy aspect occasioned by the dusky foliage of this tree. It is sometimes met with, also, in the white cedar swamps near Philadelphia and New York; but in these places, which are always miry, and sometimes submerged, its vegetation is feeble." (*Michx.*) The regions in which the black spruce is most abundant are often diversified by hills; and the finest forests are found in valleys, where the soil is black, humid, deep, and covered with a thick bed of moss; and where the trees, though crowded so as to leave an interval of only 3 ft., or at the most 5 ft., between the trunks, attain their greatest height. It is found in the same countries on the declivities of the mountains, where the soil is strong, dry, and covered only with a thin bed of peat, and on what are called in America the poor black lands; but in these situations it does not exceed 50 ft. in height, with short thick leaves, of a blackish green, and cones scarcely more than half their usual size. This tree is called *épinette noire*, and *épinette à la bière*, in Canada; *double spruce* in the district of Maine; and *black spruce* in Nova Scotia. It has been long known in Europe; and Josselyn, in his *History of New England*, published in London, in 1672, informs us that it was considered, at that period, to furnish the best yards and topmasts in the world. It was introduced into England by Bishop Compton, before 1700. Cones being frequently imported, the tree is abundant in British nurseries, and has been generally distributed as an ornamental tree; which it richly merits, not only on account of the colour of its cones when young, but of the dense habit of growth of the tree.

Properties and Uses. The black spruce, according to Pursh, is of "great mechanical use" in America, besides being "the tree of which that wholesome beverage called spruce beer is made." Michaux says "the distinguishing properties of the black spruce are, strength, lightness, and elasticity. In the dockyards of the United States, the spars are usually of black spruce,

from the district of Maine; and it is exported in great quantities, for the same purpose, to the West Indies and Liverpool. The knees of vessels, at Boston and in the district of Maine, are sometimes made of the base of this tree, and one of the principal roots; and it is substituted for oak in many places, where the timber of that tree is becoming scarce. In Maine and Boston, it is often employed for the rafters of houses, and is more esteemed for that purpose than even the hemlock spruce. It is sometimes used for floors; for which purpose it is found tougher than the white pine (*P. Strôbus*), but is more liable to crack. In all these regions, but particularly in Maine and New Brunswick, the black spruce is sawn into boards of considerable width, which are sold a fourth cheaper than those of white pine, and are exported in great quantities to the West Indies and to England; being used in the latter country, principally at Birmingham and Manchester, for packing-cases. This species is not resinous enough to afford turpentine as an article of commerce; and the wood snaps when burning, like that of the chestnut.

Mode of making Spruce Beer. The following is the method given by Du Hamel: —“To make a cask of spruce beer, a boiler is necessary, which will contain one fourth part more than the quantity of liquor which is to be put into it. It is then filled three parts full of water, and the fire lighted. As soon as the water begins to get hot, a quantity of spruce twigs is put into it, broken into pieces, but tied together into a faggot or bundle, and large enough to measure about 2 ft. in circumference at the ligature. The water is kept boiling, till the bark separates from the twigs. While this is doing, a bushel of oats must be roasted, a few at a time, on a large iron stove or hot plate; and about fifteen *galettes*, or as many sea biscuits, or if neither of these are to be had, fifteen pounds of bread cut into slices and toasted. As these articles are prepared, they are put into the boiler, where they remain till the spruce fir twigs are well boiled. The spruce branches are then taken out, and the fire extinguished. The oats and the bread fall to the bottom, and the leaves, &c., rise to the top, where they are skimmed off with the scum. Six pints of molasses, or 12 lb. or 15 lb. of coarse brown sugar, are then added; and the liquor is immediately tunned off into a cask which has contained red wine; or, if it is wished that the spruce beer should have a fine red colour, five or six pints of wine may be left in the cask. Before the liquor becomes cold, half a pint of yeast is mixed with it, and well stirred, to incorporate it thoroughly with the liquor. The barrel is then filled up to the bung-hole, which is left open to allow it to ferment; a portion of the liquor being kept back to supply what may be thrown off by the fermentation. If the cask is stopped before the liquor has fermented 24 hours, the spruce beer becomes sharp, like cider; but, if it is suffered to ferment properly, and filled up twice a day, it becomes mild, and agreeable to the palate. It is esteemed very wholesome, and is exceedingly refreshing, especially during summer.” (*Du Ham. Arb.*, i. p. 17.) According to Michaux, “the twigs are boiled in water, a certain quantity of molasses or maple sugar is added, and the mixture is left to ferment.” The essence of spruce (which is what spruce beer is made from in this country) is obtained “by evaporating to the consistence of an extract the water in which the ends of the young branches of black spruce have been boiled.” Michaux adds that he cannot give the details of the process for making the extract, as he has never seen it performed; but that he has often observed the process of making the beer, in the country about Halifax and the Maine, and that he can affirm with confidence that the white spruce is never used for that purpose. He also states that spruce beer is considered very salutary, and, in long voyages, is found efficacious in preventing attacks of the scurvy.

Statistics. In England. At Kenwood, Hampstead, 40 years planted, it is 28 ft. high, the diameter of the trunk 1 ft. 6 in., and of the head 20 ft. In Surrey, at Deepdene, 9 years planted, it is 20 ft. high. In Sussex, at KJdbrooke, it is 60 ft. high, the diameter of the trunk 3 ft., and of the head 45 ft. In Wiltshire, at Longest, 80 years planted, it is 53 ft. high. In Buckinghamshire, at Temple House, 40 years planted, it is 30 ft. high. In Radnorshire, at Maeslaugh Castle, 50 years planted, it is 70 ft.

high, the diameter of the trunk 2 ft. 10 in., and of the head 36 ft. In Suffolk, at Finborough Hall, 60 years planted, it is 90 ft. high, the diameter of the trunk 2 ft. 9 in., and of the head 50 ft. In Worcestershire, at Croome, 40 years planted, it is 35 ft. high. — In Scotland. In Banffshire, at Gordon Castle, it is 25 ft. high, with a trunk 9 in. in diameter; at Cullen House, 80 years old, it is 77 ft. high, the diameter of the trunk 3 ft. 6 in., and of the head 50 ft. In Clackmannanshire, in the garden of the Dollar Institution, 10 years planted, it is 12 ft. high. In Forfarshire, at Courtachy Castle, 14 years planted, it is 19 ft. high. — In Ireland. At Dublin, in the Glasnevin Botanic Garden, 35 years planted, it is 35 ft. high. In Fermanagh, at Florence Court, 40 years planted, it is 45 ft. high; at Castle Coole, 40 years planted, it is 50 ft. high. In Louth, at Oriel Temple, 56 years planted, it is 56 ft. high.

Commercial Statistics. Plants, in the London nurseries, two-years' seedlings, are 20s. per thousand; transplanted plants, 2 ft. high, 25s. per thousand.

‡ 4. *A. (N.) RUBRA* Poir. The red Spruce Fir, or Newfoundland red Pine.

Identification. Poir. Dict. Encyc. ; Du Roi Harbk., ed. Pott., 2. p. 182.

Synonymes. *P. americana rubra* Wang. Beyt., p. 75. ; *Pinus rubra* Lamb. Pin., 1. t. 38.

Engravings. Lamb. Pin., ed. 2., 1. t. 38. ; Wang. Beyt., t. 16. f. 54. ; and our fig. 2226.

Spec. Char., &c. Leaves solitary, awl-shaped, acuminate. Cones oblong, blunt; scales round, somewhat 2-lobed, entire. (*Lamb. Pin.*) Leaves little more than $\frac{1}{2}$ in. long; slightly tetragonal. Cones about 1 in. long, and $\frac{1}{2}$ in. broad; scales notched. Seeds very small. A large tree, cultivated in England before 1755; flowering in May.

Variety. *A. (n.) r. 2 cærulea*, *A. cærulea* Booth, is a variety or subvariety of which there are young plants in the Flötbeck Nurseries, which were received from M. Reichenberg of Leipsic, in 1832. It has glaucous leaves, and appears to us to differ from *A. (n.) rubra* only in the colour of the cones.

Description, &c. The red spruce, although it is treated as a species by Mr. Lambert, and by Pursh, Wangenheim, and others, is considered by Michaux to be merely a variety of *A. nigra*. (See p. 2312.) According to Mr. Lambert, Wangenheim describes it as a tree not exceeding 30 ft. in height, with short, awl-shaped, acute leaves, and a reddish brown bark. The cones are rather longer and redder than those of *A. nigra*, and covered with resin. Mr. Lambert states that, on examining two parcels of cones obtained from America, he found those of *A. rubra* "longer, larger, more obtuse, of a shining reddish brown colour; the scales semicircular, each divided by a notch in the middle, and with their margins entire." Michaux says that the red spruce is in no way inferior to the black spruce in the quality of its timber, which "unites in the highest degree all the good qualities that characterise the species." He also states that, instead of being a low tree, it is superior in size to the black spruce, as it generally grows in richer soil; and that the wood is reddish, instead of being white. In Lawson's *Manual*, it is stated that *A. rubra* differs essentially both from *A. nigra* and *A. sibirica* in all its parts; and particularly in its leaves, which are more slender and sharper-pointed than in either of these species. (*Man.*, p. 369.) According to Wangenheim, it is a native of Nova Scotia and Newfoundland, and the more northern parts of North America. It was cultivated in England, by Miller, before 1755. The rate of growth is the same as that of *A. nigra*, from which the trees in the Horticultural Society's Garden, and at Dropmore, seem scarcely to differ, except in the colour of the cones.

Statistics. In England: in Berkshire, at Bearwood, 14 years planted, it is 30 ft. high; in Yorkshire, at Hackness, 40 years planted, it is 60 ft. high, the diameter of the trunk 1 ft. 8 in., and of the head



23 ft.; at Grimston, 13 years planted, it is 40 ft. high. In Ireland, at Dublin, in the Glasnevin Botanic Garden, 35 years planted, it is 35 ft. high. In France, in the Park of Clerveaux, 28 years planted, it is 39 ft. high. In Bavaria, in the English Garden at Munich, 18 years planted, it is 14 ft. high.

25. *A. SMITHIANA* Wall. Smith's, or the Himalayan, Spruce Fir.

Synonymes. *Pinus Smithiana* Wall. Pl. Asiat. Rar., 3. p. 24. t. 346. Cat., No. 6063., Lamb. Pin., 3. t. 88.; *P. Khasrow* Royle III., t. 84. f. 1.; *A. Morinda* Hort.; Raga, or Raggioe, in the Parbutee language. *Engelmannia*, Wall. Pl. As. Rar., t. 246.; Royle III., t. 84. f. 4.; Lamb. Pin., 3. t. 88.; and our fig. 2229. from Royle.

Spec. Char., &c. Leaves compressed, tetragonal, straight, awl-shaped, sharp-pointed. Cones ovate-oblong; scales obovate-roundish, coriaceous, rigid, smooth on the margin. Crest of the anthers roundish, irregularly crenated. (*D. Don.* in *Lamb. Pin.*) Leaves, in Royle's specimen, and in the Horticultural Society's Garden, from 1 in. to 1½ in. in length. Cone, in Royle's figure, 6 in. long, and 2½ in. broad; scale 1½ in. in length, and the same in breadth at the widest part. Seeds about the size of those of the common spruce; with the wing, ½ in. long, and ¾ in. broad. A pyramidal drooping-branched tree; growing, in the Himalayas, to the height of 50 ft. Introduced in 1818.

Varieties. Dr. Royle observes that the leaves of *A. Smithiana*, in Wallich's figure, are much broader than those in his figure; and that they may probably be different species or varieties. Judging from the leaves, the tree in the Horticultural Society's Garden appears to be Dr. Royle's variety.

Description, &c. A pyramidal tree, 50 ft. or more in height, with a light grey bark. Branchlets remotely verticillate, spreading, somewhat pendulous. Unexpanded buds copper-coloured. Leaves turned in every direction; from 1 in. to 1½ in. long; erect and spreading, fine, compressed-tetragonal, straight, awl-shaped, stiff and mucronate, rigid; pale green, and somewhat glaucous, arising from a very faintly marked silvery line in the grooves between the angles. Male catkins solitary, thick, oval-oblong, obtuse; scarcely 1 in. long; yellow, with numerous oblong-obtuse, revolute, brown scales, torn on the margin. Anthers linear-wedge-shaped; 2-celled, opening beneath longitudinally by two fissures; 3 lines long; crowned with a roundish, slightly crenulated, cartilaginous, rather rigid, convex crest. Cones terminal, solitary, pendulous, ovate-oblong, cylindrical, 4—7 in. long, swelled in the middle; scales obovate-roundish, coriaceous, rigid, quite entire, rarely cracked; brown, convex, smooth, loosely imbricated. Seeds wedge-shaped, angled; brown, with a crustaceous testa; wing unequally sided, obovate, thinly membranaceous, dark yellow, truncate at the apex, obsoletely crenulated. (*Lamb., Laws., and obs.*) According to Royle, a very fine resin is secreted on the cones, which would yield a superior kind of turpentine. The rate of growth of this tree in British gardens is almost as rapid as that of the common spruce, perhaps equally so. A tree at Hopetoun House, raised from seed in 1818, was, in June, 1837, 17 ft. 6 in. high; though the early growth of the plant had been checked by its having been kept for two years in a pot. The tree in the Horticultural Society's Garden has been 8 years planted, and is 12 ft. high. The Himalaya spruce is a native of Kamaon and Sirmore; and, according to Professor Don, it is chiefly

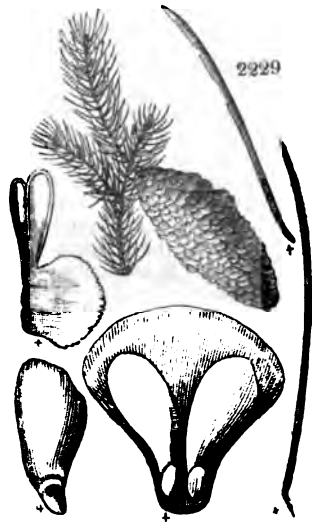

distinguished from *A. orientalis* Tourn, *P. orientalis* Lamb. Pin., t. 39., a nearly related species from Armenia and the western parts of Georgia, by its more compressed and slenderer leaves, and by its larger cones with broader scales. Cones of this species were first sent to the Earl of Hoptoun, by Dr. Govan of Cupar, in 1818; who had received them from his son in the East Indies, under the name of khutrow; and from these seeds six plants were raised the same year. After having been kept in pots for two years, two of them were planted in the arboretum at Hoptoun House, one was sent to the Horticultural Society of London, and the remainder to the Botanic and Experimental Gardens at Edinburgh. We have already mentioned that the larger of the two at Hoptoun House was 17 ft. 6 in. in June, 1837; the diameter of the trunk, at 1 ft. from the ground, 2 ft. 2 in.; and of the space covered by the branches, 11 ft. The branches, Mr. Smith informs us, are a little pendulous; and the leading shoot, in 1836, was about 18 in. long. Some scions from the side branches of this tree have been grafted, in the herbaceous manner, on the common spruce, at the height of 4 ft. or 5 ft. from the ground, allowing three or four tiers of branches of the spruce to remain; and the contrast between these branches and those of the Himalayan spruce is very striking. Several plants have been raised from the trees at Hoptoun House by cuttings, which form as handsome young trees as those raised from seed. Cones and seeds have since been received by different persons; and there are several in Lawson's museum, Edinburgh. These cones, it is observed, are in size and shape somewhat resembling those of *A. excelsa*, but differ in their scales, which are almost round and entire on the margin; while those of the Norway spruce are of a rhomboidal shape, and rugged or notched on the outer extremity. The seeds and wings are also very similar. (*Lawson's Manual*, p. 370.) There can be little or no doubt, but that this tree is as hardy in the climate of Britain as the common spruce; and, as it is unquestionably more ornamental, it well deserves a place in every collection. It is readily propagated by cuttings; and, as the trees in this country will probably in a short time produce cones, plants, if there should be an extensive demand for them, will soon be nearly as cheap as those of the common spruce fir. In the mean time, the price, in the London nurseries, is 21s. each. A great many plants of this species have been raised in Knight's Exotic Nursery, from seeds received from the Malayas, and extensively distributed under the name of *P. Pindrow*. Some confusion in the description of this species, in the *Penny Cyclopædia* and in *Lawson's Manual*, has resulted from the cones in Dr. Wallich's figure being placed upright, which, if they had been actually so, would have constituted it a *Picea*; and, accordingly, Dr. Lindley calls it the Indian silver fir. (See Professor Don, in Lambert's third volume, t. 88.)

‡ 6. *A. (?) E.* ORIENTALIS Tourn. The Oriental Spruce Fir.

Identification. Tourn. Cor., 41.; Du Ham. Arb., 1 p. 4.

Synonymæ. *Pinus orientalis* Lamb. Pin., ed. 2, 1. t. 39., *Lia Sp. Pl.*, 1421., *Syst.*, ed. Reich., 4. p. 176., *Vitman. Sp. Pl.*, 5 p. 346.

Engraving. Lamb. Pin., ed. 2, 1. t. 39.

Spec. Char., &c. Leaves solitary, tetragonal. Cones ovate-cylindrical; scales rhomboid. (*Lamb. Pin.*) Mr. Lambert states that he inserts this species on the authority of Tournefort, who says (*Voy. du Levant*, p. 288.) that he found it growing in the vicinity of Trebisonde, where it is known by the name of elate. Its trunk and branches he states to be about the size of those of *Picea pectinata*. The leaves are 4 or 5 lines in length, and not more than half a line in breadth; their colour is a shining greenish brown. The cones are described as being nearly cylindrical, about 2½ in. long, and 8 or 9 lines in diameter; pointed, and composed of soft, thin, rounded scales, which cover very minute and resinous seeds. The above description was written in 1804, before Mr. Lambert had seen a specimen of *A. orientalis*, either recent or dried, from a drawing made of the plant in the time of Tournefort. Previously to the publication of his second edition, Mr. Lambert received a specimen from Sir Gort Ouseley, collected by that gentleman in the vicinity of Teflis; from examining which, he states the specific distinctions of *A. orientalis* to be: "short quadrangular leaves, closely and imbricatedly arranged on the branches; and oblong elliptical cones, four times shorter than those of *A. excelsa*, with rhomboidal entire scales. The leaves are twice or thrice shorter than those of *A. excelsa*, and are distinctly mucronate, not pointless, as represented in Mr. Lambert's figures. The scales of the cone finally become emarginate, or slightly crenulate. Mr. Lambert's figure being, according to his own account, very imperfect, we have not copied it. We have already mentioned, under *A. alba*, the opinion of Loloiseur Deaulchamps (formed, as he states, after comparing the drawings made for Tournefort with the specimens of *A. alba* brought from America by Michaux), that *A. orientalis* is only a variety of that species. (See *N. Du Ham.*, v. p. 291.) We think it only a variety of *A. excelsa*.

Sect. ii. *Leaves flat, generally glaucous beneath, imperfectly 2-rowed.*

† 7. *A. DOUGLASSII* Lindl. The *trident-bracted*, or Douglas's, Spruce Fir.

Identification. Lindl in Penn. Cyc., 1. p. 32.

Synonymes. *P. taxifolia* Lamb. *Pin.*, ed. 2, 2. t. 47.; *Pursh Fl. Amer. Sept.*, 2. p. 640.; *A. callifolia Hort.*; *Pinus Douglasii* Sabine MSS., Lamb. *Pin.*, vol. 3. t. 90.; the Nootka Fir, *Smith in Rees's Cyc.*, No. 29.

Engravings. Lamb. *Pin.* ed. 2, 2. t. 47., and vol. 3. t. 90.; our *fig.* 2230., from a specimen and sketch sent to us by Mr. M'Nab, jun., of the Caledonian Horticultural Society's Garden; and the plate of this species in our last Volume, taken from the young tree in the London Horticultural Society's Garden, and from a drawing in the possession of the Horticultural Society.

Spec. Char., &c. Leaves flat, blunt, entire, pectinate, silvery beneath. Cones ovate-oblong. Bractees elongated, linear, 3-pointed. (*D. Don in Lamb. Pin.*) Leaves from 1 in. to 1½ in. long. Cones from 3¼ in. to 4 in. long, and 1½ in. to 1¾ in. broad; scales, without the bractea, 1½ in. long, and the same broad; with the bractea, 1¾ in. in length. Seed, with the wing, ¾ in. long, and ⅜ in. broad; without the wing, ½ in. long, and ¼ in. broad. The seeds are about the same size as those of *Picea pectinata*, but more oblong. Cotyledons, ?. A native of the north-west coast of North America, where it was discovered by Menzies about 1797, and afterwards by Douglas, who introduced it in 1826. It flowers at Dropmore in May.

Varieties. Pursh states that he has among his specimens two varieties, or probably distinct species, which, for want of the fructification, he can not decide upon. One has acute leaves, green on both sides; and the other emarginate leaves, glaucous beneath. The seedling plants of *A. Douglasii*, raised in England, exhibit some difference in the length and width of their foliage; but, as far as we have observed, none worthy of being propagated by extension as a distinct variety. Mr. M'Nab, jun., and Mr. Lawson, however, inform us that there is a very distinct variety in several gardens in the neighbourhood of Edinburgh, which was raised from seeds sent home by Drummond. The largest specimen is in the collection at Lahill, near Largo, in Fife, where it is 14 ft. high; and there is one in the Caledonian Horticultural Society's Garden, under the name of *A. taxifolia*, which, in 1837, was 5 ft. high. From what Mr. M'Nab, jun., told us, it may be described as follows:—

† *A. D. 2 taxifolia.* — Stem and side branches straight; while in *A. Douglasii* they are always, when young, more or less in a zigzag direction, though they become eventually straight. Leaves twice the length of those of *A. Douglasii*, and of a much deeper green. *Fig.* 2230., is from a specimen and a sketch received from Mr. M'Nab, showing the foliage and manner of branching of *A. Douglasii* in the Caledonian Horticultural Society's Garden, and which corresponds exactly with the trees of this name in the London Horticultural Society's Garden, and at Dropmore. *Fig.* 2231. is from a sketch of the mode of ramification and of the foliage of a tree named *A. taxifolia* in the Edinburgh Botanic Garden, and which was raised from seeds received from the late Mr. Thomas Drummond, after the arctic expedition. It is, Mr. M'Nab observes, an upright-growing tree; and, with its long and dark leaves, very distinct from all the specimens of *A. Douglasii* that he had seen elsewhere. The tree

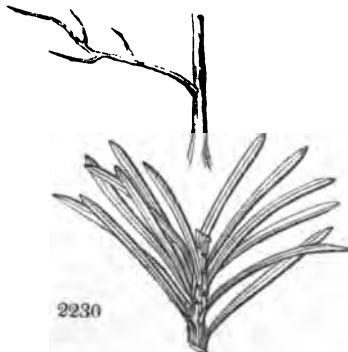

2231

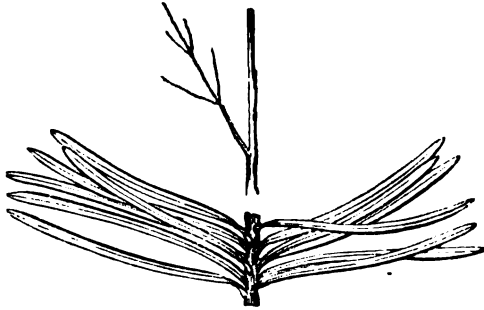

of *A. D. taxifolia* in the Edinburgh Botanic Garden is 8 ft. high, diameter of the head 4 ft. 6 in., and of the trunk 3 in. The tree of *A. Douglasii* in the Caledonian Horticultural Society's Garden Mr. M'Nab describes as a large bush, with a very weak leading shoot, 8 ft. high, diameter of the head 10 ft., and of the trunk 4 in.

Description, &c. A large conical tree, with a rugged greyish brown bark, from 6 in. to 9 in. thick, and abounding in balsamic resin. Leaves somewhat pectinate and spreading, narrow-linear, obtuse on the margin and apex, quite entire, flat; dark green above, marked on the middle with a depressed line, and silvery beneath; 1 in. long. Male catkins short, dense, obtuse, scarcely $\frac{1}{2}$ in. long. Bractees scarious, concave, very obtuse, ciliate and torn on the margin. Anthers obcordate, very short, 2-celled; crest very short, obtuse, thick, tubercle-like. Cones terminal on the apex of the branches, solitary, pendulous, ovate-oblong, bright brown, with many linear acuminate bractees at the base; scales roundish, concave, coriaceous, quite entire, persistent, smooth. Bracteoles linear, tricuspidate, cartilaginous and membranaceous, twice as long as the scales; teeth acuminate, middle one by much the longest. Seeds oval; testa crustaceous; wing elliptic, obtuse, chestnut brown, slightly convex on the exterior margin. (*Lamb., Penn. Cyc.*, and obs.) According to Douglas, the trunks of this species, in the forests of the north-west of America, vary from 2 ft. to 10 ft. in diameter, and from 100 ft. to 180 ft. in height. Occasionally, the tree arrives at still greater dimensions; as a proof of which, Douglas mentions a stump which still exists near Fort George, on the Columbia river, which, exclusive of the bark, and at 3 ft. from the ground, measured 48 ft. in circumference. The bark in young trees has its receptacles filled with a clear yellow resin, in the same manner as that of the balsam of Gilead; and the bark of old trees is said to make excellent fuel. The timber is heavy, firm, with few knots, about the same yellow colour as that of the yew, and not in the least liable to warp. The rate of growth of this tree, in the climate of London, appears to be nearly as great as that of the common spruce; but, as it has a tendency to send out a profusion of side branches, it does not increase in height so much as it does in width and bushiness. It often protrudes two growths in a season, but often, also, sends up contending leading shoots. When this is not the case, the terminal shoot of the season, under favourable circumstances, in a tree 6 ft. high, is from 1 ft. 3 in. to 1 ft. 8 in. in a year. The tallest specimen in the immediate neighbourhood of London is in the Horticultural Society's Garden; where, in 1837, 10 years from the seed, it was 10 ft. high. A plant at Dropmore, of the same age, was, in August, 1837, 19 ft. high, and bearing several cones.

Geography, History, &c. *Abies Douglasii* is found in immense forests in north-west America, from 43° to 52° n. lat. It was originally discovered by Mr. Menzies, at Nootka Sound, when he touched at that coast during his voyage round the world with Captain Vancouver, in 1797; and, from a specimen without flowers or cones, a figure was published by Mr. Lambert, under

the name of *Pinus taxifolia*, in 1826. It was also gathered on the banks of the Columbia by Mr. Lewis, and specimens of it were seen in his herbarium by Pursh. In 1825, the tree was re-discovered by Douglas, and cones were sent home by him, from which plants were raised by the London Horticultural Society, in 1826, and distributed throughout the country. The trees appear to be as hardy in England as the silver fir; and in Scotland, in Perthshire, at Methven Castle, they produce shoots of from 1 ft. 4 in. to 1 ft. 6 in. long every year. The tree bore cones, for the first time in England, at Dropmore, in 1835, when the plant there already mentioned produced one cone. This year (1837) it has above a dozen; so that, in all probability, there will soon be abundance of seeds of this species, from which extensive plantations may be raised, and the value of the species as a timber tree proved. In the mean time, the plant is readily propagated by cuttings, which appear to make as good trees as seedling plants.

Statistics. In the neighbourhood of London, at Muswell Hill, it is 9 ft. high; at the Duke of Devonshire's Villa, at Chiswick, and at Hendon Rectory, 9 ft. high. In Kent, at Cobham Hall, it is 8 ft. high. In Bedfordshire, at Flitwick House, it is 6 ft. high. In Berkshire, at Highclere, it is 8 ft. high; at Englefield House, 13 ft. high. In Hertfordshire, at Danesbury, it is 6 ft. high; at Chesnut, it is 9 ft. high. In Yorkshire, at Scoresby, in the garden of J. Wood, Esq., it is 19 ft. 4 in. high. In Staffordshire, at Rolleston Hall, it is 8 ft. high. — In Scotland, at Edinburgh, in the Experimental Garden, Inverleith, it is 6 ft. 6 in. high. In Cromarty, at Cool, it is 6 ft. high. In Dumfriesshire, at Jardine Hall, it is 13 ft. 2 in. high. In Fifeshire, at Lahill, the variety is 14 ft. high. In Renfrewshire, at Caldcleuch, near Glasgow, the species is 7 ft. 6 in. high.

† 8. *A. MENZIE'SII* Douglas. Menzies's, or the warted-branched, Spruce Fir.

Identification. Doug. MS., Lindl. in Penn. Cyc., 1. p. 32.

Synonymy. *Pinus Menziesii* Lamb. Pin., 3.

Engraving. Lamb. Pin., 3. t. 89; and our fig. 2232, from Lambert, and the seeds from specimens in the Horticultural Society's herbarium sent home by Douglas.

Spec. Char., &c. Leaves acute, flat; silvery beneath, turned in every direc-

tion. Cones cylindrical; scales scarios, gnawed on the margin. (*D. Don in Lamb. Pin.*) Leaves $\frac{3}{4}$ in. long. Cones from $2\frac{1}{2}$ in. to 3 in. long, and from 1 in. to $1\frac{1}{2}$ in. broad; scales $\frac{3}{4}$ in. long, and $\frac{3}{8}$ in. broad. Seed very small, scarcely $\frac{1}{8}$ in. long; with the wing, $\frac{5}{8}$ in. long. A native of the north of California, where it was discovered by Douglas, and introduced by him in 1831.

Description, &c. A tree with the general appearance of *A. Douglasii*. Branches and branchlets tubercled. Buds ovate,

acute, covered with resin. Leaves turned in every direction, resupinate from being twisted at the base, linear, mucronulate, incurved; silvery beneath,

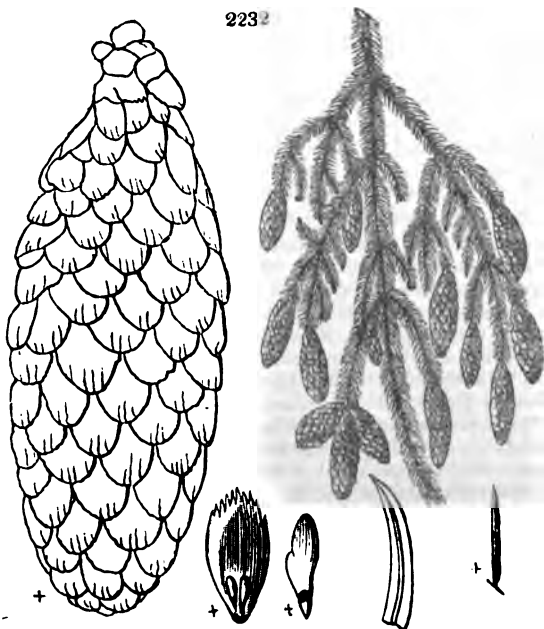

articulated with an elevated tubercle, very short, not more than 2 in. long, rigid, rather sharp-pointed, and very soon falling off the dried specimens. Cones pendulous, cylindrical, 3 in. long; scales elliptic, obtuse, loose, somewhat wavy, cartilaginous and scarios; bright brown; ragged, when mature, on the upper margin; persistent after the seeds have dropped. Bracteoles lanceolate, acute, rather rigid, irregularly crenulated on the margin; half the length of the scales. Seeds small, brown, first convex, and then flat; wing somewhat elliptic, slightly and irregularly crenulated at the apex; the other margin straight, thick, and revolute. (*Lamb., Penn. Cyc.*, and observations.) Douglas describes the wood of this species as being of excellent quality; but little is known respecting the habit of the tree. It was found on the north-west coast of America, in North California; and named by its discoverer in honour of our much esteemed friend, Archibald Menzies, Esq.; a botanist who has introduced many valuable species; and who, having discovered many others, of which he was unable to procure seeds, nearly 40 years ago, has had the pleasure of seeing them at length introduced, and brought into general cultivation. Only a very few plants of *A. Menziesii* were raised in the Horticultural Society's Garden in the year 1832; so that the species is at present extremely rare in this country; it is, however, as we are informed by Mr. Lawson and Mr. M'Nab, jun., much more plentiful in Scotland. The plant in the Horticultural Society's Garden is nearly 3 ft. high; and there are plants about the same height at Highclere and Hendon Rectory. It is readily propagated by cuttings; and plants may be procured in the nurseries at 3 guineas each.

† 9. *A. CANADENSIS* L. The Canada Pine, or Hemlock Spruce Fir.

Identification. Michx. N. Amer. Syl., 3. p. 185.

Synonymes. *P. canadensis* Lin. Sp., 21, 1421; *P. americana* Du Roi Herb., ed. Pott., 2. p. 151., *Atl. Hort. Kew.*, 3. p. 370., *Lamb. Pin.*, ed. 2., 1. t. 45., *Smith in Rees's Cyc.*, No. 22.; *P. Abies americana* Marsh. *Arb. Amer.*, p. 103.; *Perusse*, by the French in Canada; *Sapin du Canada*, Fr.; *Schierlings Fichte*, Ger.

Engravings. *Lamb. Pin.*, ed. 2., 1. t. 45.; *Michx. N. Amer. Syl.*, 3. t. 149.; *N. Du Ham.*, 5. t. 82. f. 1.; and the plates of this tree in our last Volume.

Spec. Char., &c. Leaves solitary, flat, slightly denticulate, obtuse, two-ranked. Cones oval, terminal, pendent, naked, scarcely longer than the leaves. (*Lois.*) Leaves from $\frac{2}{3}$ in. to $\frac{3}{4}$ in. long, and $\frac{1}{10}$ in. broad. Cones from $\frac{4}{5}$ in. to $\frac{7}{8}$ in. long, and $\frac{3}{4}$ in. broad; scales round-oblong, $\frac{1}{2}$ in. long, and $\frac{1}{4}$ in. broad. Seed very small, scarcely $\frac{1}{4}$ in. long; and with the wing, $\frac{3}{4}$ in. long. Native of North America. Introduced in 1736.

Description. The hemlock spruce, in Europe, is a most elegant tree, from the symmetrical disposition of its branches, which droop gracefully at their extremities, and its light, and yet tufted, foliage. In America, while the tree is young and under 30 ft. high, it is as beautiful as in England; but, when it attains its full growth, Michaux informs us, the large limbs are usually broken off 4 ft. or 5 ft. from the trunk, and the withered extremities are seen "staring out" through the little twigs which have sprung out around them. "In this mutilated state, by which it is easily recognised, it has a disagreeable aspect, and presents, while in full vigour, an image of decrepitude." This breaking of the limbs is attributed to the snow lodging upon the close, tufted, horizontal branches; and it never happens to young trees, the wood of which is more elastic. (See p. 2137.) Michaux adds that the woods in the northern states are filled with dead trees of the hemlock spruce; but he is unable to say whether they have been killed by an insect, or by some other cause. The dead moss-grown trees of this species, he adds, "which stand mouldering for 20 or 30 years, deform the forests of this part of the United States; and give them a gloomy and desolate appearance." This species has the peculiarity of sometimes ceasing to grow at the height of 2 ft. or 2 ft. 6 in. In this state, says Michaux, it has a pyramidal shape, and its compact tufted branches adhere to the ground. The trunk of the hemlock spruce is straight, and of uniform size for two thirds of its height. The branches are numerous and

spreading, but slender in proportion to their extent. The bark is light-coloured and smooth, except on very old trees. The leaves are from $\frac{1}{2}$ in. to 8 lines long, flat, mucronous, and disposed, though irregularly, in two ranks; and downy when young, and serrated, or rough, at their margins; they are of a very vivid light green, with two silvery stripes underneath. The male flowers are few together, forming a small head on a long footstalk. The cones are only a little longer than the leaves; pendulous on the extremities of the branches; green when young, but becoming brownish when ripe; the scales are few, roundish, smooth, and entire on the margins. The seeds are very small, and of a light brown, with the wings nearly white. (*Michx.*) The full-grown trees of the hemlock spruce, in England, have a rounder head, and a more pendulous habit of growth, than is the case with any other fir, either of America or Europe. Most of the largest specimens, also, such as the original tree at Mill Hill, a large tree at Woburn Farm, one at Claremont, and that at Strathfieldsaye, have forked trunks. When the tree is young, the branches are quite pendulous, and remarkably elegant. The rate of growth, in the climate of London, is rather slow; but plants, in 10 years, will attain the height of 6 ft. or 8 ft.; and in 20 years, of 15 ft. or 20 ft. The finest specimens in the neighbourhood of London are those alluded to above, which are from 50 ft. to 60 ft. in height; and some trees at Whitton (of one of which a portrait will be found in our last Volume), which are from 30 ft. to 50 ft. in height, with trunks from 1 ft. 6 in. to 2 ft. in diameter.

Geography and History. According to Pursh, the hemlock spruce is found in the most northern regions of Canada, and on the highest mountains, as far south as Carolina. Michaux says that it is a native of the coldest regions of the New World, and that it begins to appear about Hudson's Bay. Near the Lake St. John, and in the neighbourhood of Quebec, it fills the forests; and in Nova Scotia, New Brunswick, the district of Maine, the state of Vermont, and the upper parts of New Hampshire, it forms three quarters of the ever-green woods, of which the remainder consists of the black spruce. Farther south, it is less common; and, in the middle and southern states, is seen only on the Alleghanies; and, even there, it is often confined to the sides of torrents, and to the more humid and gloomy exposures. In the country east and north of Massachusetts, which, without embracing Canada, is more than 750 miles long, by about 250 miles broad, these trees are constantly found at the foot of the hills, and constitute nearly half the unbroken forests which cover that extensive region. In this district moist soils appear unfavourable to its growth; but it attains a large size on soils proper for growing corn. The hemlock spruce was introduced into England by Peter Collinson, about the year 1736; and the original tree is probably that still standing in the grounds at Mill Hill, where it has two trunks, each about 1 ft. in diameter, and 50 ft. high. (See p. 57.) The tree is occasionally found, both in France and Germany, of considerable size, and ripening its seeds. As seeds are annually imported, and even produced by the old trees in this country, the plant is not scarce in the nurseries.

Properties and Uses. The wood of the hemlock spruce, according to Michaux, is less valuable than that of any other of the large resinous trees of North America; but the bark is inestimable, in that country, for the purposes of the tanner. It is esteemed an excellence in wood to split in a straight line, which it does when the fibre is vertical: but that of the hemlock spruce is so oblique, that it makes the circuit of trunks 1 ft. 3 in. or 1 ft. 8 in. in diameter, in ascending 5 ft. or 6 ft. Besides this defect, which is general, and which renders it unfit for rural fences, the old trees frequently have their concentric circles separated at intervals, or, in the language of the country, are shaly, which greatly impairs their strength. This effect is produced by the winds, which have a powerful hold upon the large compact summit formed by the head of the hemlock spruce, exposed, as it generally is, above the heads of the surrounding trees. The wood is found to decay rapidly when exposed to the atmosphere, and is therefore improper for the external covering of

houses; which is another important defect in a country where nearly all the houses are of wood; but when covered it is of great duration; and as the white pine (*P. Ströbus*) becomes rarer, the hemlock spruce is substituted for it as extensively as possible. It is firmer, though coarser grained; affords a tighter hold to nails; and offers more resistance to the impression of other bodies. For this reason, it is employed, in the district of Maine, in the form of 2-inch planks, for threshing-floors. But the most common use, in which great quantities are consumed in the northern states, is for the first sheathing of wooden houses, which are afterwards covered with clap-boards (see p. 2284.) of white pine. For economy, the interior frame is sometimes made of hemlock spruce; and it is found, when guarded from humidity, to be as durable as any other species. It is always chosen for the laths of the interior walls, and is exported in this form to England. In the district of Maine, it is usually taken for the posts of rural fences, which last about 15 years, and are preferable to those of the grey and red oaks (*Quercus ambigua* and *Q. rubra*). It contains little resin, and the trunk is but slightly coated with turpentine, even where large pieces of bark have been a long time removed. The bark, when used for tanning, is taken from the tree in the month of June; and half the epidermis is shaved off with a plane before it is thrown into the mill. From the district of Maine, it is exported to Boston, Providence, &c., and is almost exclusively employed in the yards at those places. It is brought to New York from the upper parts of the Hudson, and is sometimes carried to Baltimore. Its deep red colour is imparted to the leather; and, though it is inferior to the bark of the oak, the American tanners think the bark of the two kinds united are better than either of them alone. Hemlock spruce bark was once exported to England, but the commerce has ceased with the demand. The Indians are said to use it in dyeing their light baskets made of red maple. (*Michx.*) The young twigs and ends of the shoots are used by the settlers as a substitute for tea; the essence of spruce is also extracted from the shoots. In England, the hemlock spruce forms one of the most ornamental of the fir family; being among needle-leaved evergreen trees what the weeping willow is among the willows. As it bears the knife, and is extremely hardy, it might be employed as hedges; for which purpose it is used in the American nurseries, along with the *Thuja occidentalis*.

Statistics. In the environs of London, at Kenwood, Hampstead, 60 years planted, it is 25 ft. high, the diameter of the trunk 2 ft. 6 in., and of the head 40 ft.; at York House, Twickenham, it is 30 ft. high, with a trunk 1 ft. 2 in. in diameter; at Muswell Hill, it is 30 ft. high; at Abercorn Priory, at Stanmore, it is 30 ft. high, diameter of the trunk 1 ft. 6 in., and of the head 33 ft. — South of London. In Devonshire, at Bystock Park, 21 years planted, it is 50 ft. high. In Dorsetshire, at Melbury Park, 15 years planted, it is 23 ft. high. In Hampshire, at Alresford, 41 years planted, it is 59 ft. high; at Strathfieldsaye, it is 45 ft. high, the diameter of the trunk 2 ft., and of the head 42 ft. In Somersetshire, at Kingweston, 12 years planted, it is 18 ft. high. In Surrey, at St. Ann's Hill, 34 years planted, it is 38 ft. high; at Claremont, it is 45 ft. high, the diameter of the trunk 2 ft. 9 in., and of the head 55 ft.; at Ockham, 35 years planted, it is 18 ft. high. In Sussex, at Westdean, 10 years planted, it is 19 ft. high. In Wiltshire, at Wardour Castle, 50 years planted, it is 30 ft. high, the diameter of the trunk 3 ft. 6 in., and of the head 43 ft. — North of London. In Bedfordshire, at Southill, it is 22 ft. high, with a trunk 1 ft. in diameter. In Berkshire, at Bearwood, 10 years planted, it is 15 ft. high; at Ditton Park, 34 years planted, it is 30 ft. high. In Herefordshire, at Stoke Edith Park, 50 years old, it is 30 ft. high, the diameter of the trunk 1 ft. 8 in., and of the head 36 ft. In Hertfordshire, at Cashobury, 30 years planted, it is 28 ft. high; at Cheshunt, 10 years planted, it is 17 ft. high. In Leicestershire, at Elvaston Castle, 16 years planted, it is 12 ft. high; at Belvoir Castle, 18 years planted, it is 15 ft. high. In Nottinghamshire, at Clumber Park, it is 25 ft. high. In Staffordshire, at Trentham, it is 16 ft. high. In Warwickshire, at Combe Abbey, 60 years planted, it is 41 ft. high, the diameter of the trunk 2 ft. 3 in., and of the head 36 ft. In Worcestershire, at Croome, 40 years planted, it is 35 ft. high. In Yorkshire, at Grimston, 12 years planted, it is 18 ft. high. — In Scotland, at Hopetoun House, it is 35 ft. high, the diameter of the trunk nearly 2 ft., and of the head 21 ft. In Roxburghshire, at Minto, 50 years planted, it is 35 ft. high. In Perthshire, at Taymouth, it is 20 ft. high, the diameter of the trunk 1 ft. 6 in., and of the head 18 ft.; another, 50 years planted, is 26 ft. high, the diameter of the trunk 2 ft. 6 in., and of the head 18 ft. In Ross-shire, at Brahan Castle, it is 20 ft. high, the diameter of the trunk 14 in. — In Ireland, in Louth, at Oriel Temple, 35 years planted, it is 32 ft. high. — In France, at Colomby, near Metz, 67 years planted, it is 40 ft. high, the diameter of the trunk 1 ft. 6 in. — In Hanover, in the Botanic Garden, Göttingen, 20 years planted, it is 20 ft. high. — In Saxony, at Würbitz, 60 years planted, it is 60 ft. high, the diameter of the trunk 3 ft., and of the head 40 ft. — In Austria, at Vienna, at Brick on the Leytha, 36 years planted, it is 36 ft. high. — In Bavaria, in the English Garden at Munich, 10 years planted, it is 10 ft. high. — In Prussia, near Berlin, at Sans Souci, 50 years planted, it is 40 ft. high.

Commercial Statistics. Plants, in London, are 25s. per hundred; and 2 ft. high, 50s. per hundred: at Bollwyller, from 3 francs to 5 francs each; and at New York, 50 cents.

‡ 10. *A. DUMOSA* Lamb. The bushy alpine Spruce Fir.

Synonymes. *Pinus dumosa* Lamb. *Pin.*, ed. 2, 1. t. 46; *Abies Brunoniána* Lindl. in Penn. Cyc., No. 9; *P. decídua* Wall. *MS.*; *P. Brunoniána* Wall. *Plant. As. Rar.*, 3. p. 24. t. 247.

Engravings. Lamb. *Pin.*, ed. 2., 1. t. 46; Wall. *Plant. As. Rar.* 3. t. 247.; and our *Figs.* 2233. and 2234.

Spec. Char., &c. Leaves solitary, linear, obtuse, mostly on one side of the branches; glaucous beneath, denticulated. Cones ovate, terminal, solitary: bracteoles wedge-shaped, plicate, emarginate, glabrous (*Lamb. Pin.*) Leaves $\frac{1}{2}$ in. to 1 in. long. Cones, scales, and seeds scarcely different from those of *A. canadensis*. A native of Nepal, not yet introduced.



2233

Description. A dense and very bushy tree, 70 ft. or 80 ft. high, with the appearance of *Abies canadensis*. Branches numerous, spreading, twiggy, covered with an ash-coloured brownish bark. Leaves solitary, linear, obtuse, 2-rowed, somewhat pectinate, more crowded than in *A. canadensis*; from 5 lines to 1 in. long, 1 line broad; green above, shining and glaucous beneath; deflexed on the margin, obsolete denticulate towards the apex. Cones terminal, solitary, ovate, mucronate, smooth, sessile, 1 in. long; scales roundish, somewhat membranaceous, brownish, curled and torn on the margin: bracteoles very short, somewhat membranaceous, roundish, wedge-shaped, slightly plicated, nearly fan-shaped, emarginate; margins unequal, smooth. Seeds small, cuneate, ferruginous, furnished with an oblong, obtuse, pale, shining, membranaceous wing. (*Lamb., Wall., and Penny Cyc.*) Dr. Wallich observes that the leaves of this fir are mealy beneath, and that they are so



2234

extremely deciduous, that the slightest shake of the branch is sufficient to detach them. The natives, who call the tree *Tangshing*, do not use the wood, as they find it liable to warp. It was discovered by Captain Webb, and named *Brunoniána* by Dr. Wallich, in honour of Mr. Brown; the specific name of *dumosa* refers to the bushy habit of the tree. This species is a native of Nepal and Bhotan. Dr. Wallich's collectors gathered it on the lofty peak of Gossainthan. According to Dr. Royle, it is rare, and was only seen by him on the more northern parts of the hills. Mr. Lambert justly observes that this species is very nearly allied to the hemlock spruce; but he adds that it differs from it, in having longer and more crowded leaves, with their margins deflected. The cones are larger, with their scales wavy, and somewhat erose at the edges, and the bractees not fringed at the margins. As there can be little doubt of its being quite hardy in England, it is much to be desired that it should be introduced.

‡ 11. *A. CEPHALONICA*. The Cephalonian Silver Spruce Fir.

Synonymes. *Koukounaria*, and also *Elatos*, in Cephalonia; *A. taxifolia* Hort.; *A. luscombeana* Hort.; the Mount Enos Fir.

Engravings. Our *Figs.* 2235. and 2236., from living specimens received from Hampton Lodge, Luscombe, and Dropmore.

Spec. Char. Cones, ♀. Leaves subulate, flat; dark green above, and silvery beneath; tapering from the base to the summit, which terminates in a sharp spine. Petioles very short, dilated lengthwise at the point of their attachment to the branches; the dilated part of a much lighter green than the rest of the leaf. A tree, in its native country (Cephalonia), upwards of 60 ft. high, with a trunk 9 ft. or 10 ft. in circumference, and numerous side branches, which, when young, give it the general appearance of an araucaria. Introduced in 1824.

Description. General Charles James Napier, who, when governor of Cephalonia, paid great attention to this tree, and first sent seeds of it to England, informs us that the largest specimens which he saw of it in Cephalonia were 60 ft. high and upwards; and that the side branches, when the tree is not crowded by others, are very numerous, and spread out to a great distance, so as to form a very broad tree in proportion to its height. The leaves, on plants raised in England, are equally and thickly distributed over the branches, and stand out nearly at right angles on every side. They are of a fine shining dark green above, and have two rather obscure silvery lines, separated by the midrib, beneath. They differ from those of all other species of *Abies* and *Picea*, in terminating in a long, brown, sharp, prickle, and in having the footstalks (which are so short that the leaves are almost sessile) dilated lengthwise in the direction of the branches; the dilated part being of a much

lighter green than the rest of the leaves. The leaves, on branches at some distance from the ground, and on the leading shoot, as compared with those of other pines and firs, may be described as dagger-shaped, or as resembling miniature bayonets. They are equally and closely distributed over the branches; and, being almost without footstalks, and broad at the base in proportion to their length, they give the branches which are clothed with them a good deal of the appearance of *Araucaria brasiliensis*. The leaves, on the branches which are close to the ground, are rather more two-rowed, in the manner of the silver fir, than those on the higher branches; as may be seen in fig. 2236., which represents a portion of the lowest branch of the young tree in the pinetum at Dropmore. The colour of the bark of the young shoots is a decided brown; which, contrasting with the light colour of the petioles, and the dark green of the upper surface of the leaves, and their silvery lines below, gives the plant at once a rich and a lively appearance. The buds are prominent, somewhat square-sided, pointed, and slightly covered with resin. In plants kept under glass, they have much more resin than in those kept in the open air. The branches are very numerous; and, though originating at the main stem in regular tiers, yet, at a short distance from it, they divaricate in all directions; and, in plants in pots, from 3 ft. to 4 ft. high, which are the largest that we have seen, they form a bush broader than it is high. This is also said to be the case with the plants in the open ground at Luscombe and at Hampton Lodge. The general resemblance which the plant, in this state, has to an araucaria is very remarkable; and, if the cones should prove to be as different from those of other species of *Abies* and *Picea* as the leaves, this tree will form a connecting link between the firs and the araucarias. The cones have not yet been seen in Britain; but General Napier



2235

thinks that they are sometimes pointing upwards, and sometimes turned down; and Mr. Curling, who was superintendent of the Colonial Farm in Cephalonia at the time that General Napier was governor of the island, and who is now steward to Sir Henry Bunbury, at Mildenhall, Suffolk, thinks that he recollects that the cones were soft and pendulous, like those of the spruce fir. This point, through the kindness of General Napier, now (January, 1838,) residing at Bath, who has promised to procure cones for us, and a specimen of the wood, we hope soon to be able to determine.

Geography. The only known habitat of this remarkable fir is in Cephalonia, on a ridge of mountains, the highest point of which was anciently called Mount Enos; but the general name of the ridge is now the Black Mountain. This ridge is between twelve and fifteen miles in length, and between 4000 ft. and 5000 ft. above the level of the sea. Dr. Holland, who saw it in 1813, describes it as the most striking feature in the general aspect of the island. On the summit of the highest point of this ridge, the Mount Enos of antiquity, stood, according to Strabo, an altar dedicated to Jupiter Ænesius; and Dr.



2236

Holland was informed that some of the stones of this altar, and of the bones of the animals sacrificed on it, were still occasionally to be found on its site. "The name of the Black Mountain," he says, "was obtained from the large pine forests which once covered its acclivity; but, during the disturbed state of the islands fifteen years ago (about 1798), these forests were wantonly set on fire, and in great part destroyed; so that now (Feb., 1813) the appearance of the mountain entirely contradicts its name. This is especially the case on its southern side, where the precipitous point, which rises by a single majestic elevation from the base to the summit, is broken by numerous deep gullies, displaying the white limestone rock of which the mountain is composed." (*Travels in the Ionian Isles, &c.*, p. 35.)

The main ridge of the Black Mountain lies in the direction of north-west and south-east. The upper part only is, or rather was, covered with forest; while the lower part of the sides is covered with vineyards, olive grounds, corn fields, and gardens. The ridge, General Napier informs us, is very narrow, and its sides steep, and in many places almost without soil; nevertheless, this fir springs, in many places, from the crevices of the rock, though, like other mountain trees in similar cases, the tree only attains a large size in mountain hollows, where the soil is deep and the situation sheltered. Neither Pouqueville nor Olivier mention this forest; and, though Dr. Pococke speaks of the mountain, the highest point of which he calls Mount Gargasso, he does not mention its trees. This omission is, however, accounted for by the fact, that Dr. Pococke did not go on shore on the island. In General C. J. Napier's work, entitled *The Colonies*, published in 1833, there are more ample details. It is there stated that, notwithstanding a great part of this forest was burned down several years ago, it is still very extensive; though it is greatly injured by the vast number of goats which are permitted to range at pleasure among the trees, and which destroy the young ones by uniformly biting off the leading shoot. As wood is very valuable in Cephalonia, the forest, General Napier observes, might be made a source of great riches and utility; and twenty years' care, would make it magnificent. Count Marine Mataxa, one of the nobles of the island, he adds, told him that, "when he was presented to the Emperor Napoleon, His Majesty's first question was about the forest on the Black Mountain." (*Colonies, &c.*, p. 336.) The following is an extract from an *Agricultural Report* made to Colonel Conyers respecting this forest in 1832, by Mr. Edward Curling, the director of the Colonial Farm already mentioned:—"Before I conclude, I must draw your attention to the fine forest of firs that might be had on the Black Mountain of Cefalonia. With a very little attention, this would form a source of riches to the islands, which, at present, import all the wood they require for houses, ship-building, &c. This forest, at one time, contained some of the finest trees in the world, but was unfortunately burned down by the negligence of some Greeks in setting fire to their lands; and, since then, the goats have effectually prevented anything like a good tree from growing. These animals always eat off the leading shoot, and thus entirely ruin the tree: for this fir does not renew its leading shoot when injured. And thus, only stunted crooked trees are to be found, except a few that have sprung up since Colonel Napier took pains to keep the goats out; though, immediately that the island was left in less attentive hands, the goats renewed their incursions. Even these young trees are in danger of being destroyed by the women who collect resin, who take off about a foot of the bark of the leading shoot; and, of course, the tree dies. Colonel Napier has made a road up to the forest; and the thinnings would pay all the expenses of taking care of it, as firewood sells enormously dear at Argostoli." (*Colonies, &c.*, p. 283.)

"It has been said that 'it is useless to take any pains to protect this forest, as there is scarcely a tree in it worth the trouble;' but this is the very reason why it should be protected, to prevent the trees from being injured as they have hitherto been, and to allow the trees to attain a timber-like size." (*Ibid.*)

History. As far as we have been able to discover, no botanist has yet

noticed this tree. We were once inclined to conjecture that it might be the *Abies orientalis* of Tournefort, notwithstanding the discrepancy between the description and the Cephalonian plant; but, having examined the specimen of *Abies orientalis* in Mr. Lambert's herbarium, we are satisfied that the latter is a variety of the common spruce fir. The merit of introducing *A. cephalonica* into England entirely belongs to General Napier, who, from his work, *The Colonies*, and also from a pamphlet by him, entitled, *Memoir on the Roads of Cephalonia*, seems to possess an enthusiastic attachment to the island, and an ardent desire for its improvement. He was particularly anxious that this forest ridge should be enclosed so as to exclude the goats, and to allow the trees to grow up and become timber; and, when he was governor, made many remonstrances on the subject to Sir Frederick Adam, the chief commissioner, but without effect. In 1824, in compliance with a request of Henry L. Long, Esq., of Hampton Lodge, near Farnham, who was desirous of knowing the species of fir described by the ancient writers as the *peukē* and the *clatē*, Colonel Napier sent a packet of seeds of the Cephalonian fir to England. The seeds were without the cones, and were sent to the care of the colonel's sister, Lady Bunbury. The packet was duly forwarded to Hampton Lodge; but some seeds having dropped from it, Lady Bunbury gave these seeds to Charles Hoare, Esq., of Luscombe. Mr. Richard Saunders, the woodreeve at Luscombe, in a letter dated November, 1837, informs us that he recollects receiving the "seeds from Colonel, now General, Napier, about thirteen years since;" and "hearing that the general had obtained them from his brother, at that time governor of Cefalonia." "The seeds," he adds, "were of the largest size. I raised twelve plants from them, four of which I lost, when young, by damp and frost, having planted them out in the open ground at the age of two years only. Three of the plants raised were given to Mr. Pince of the Exeter Nursery, and one to Mr. Pontey of the Plymouth Nursery. The other four plants are remaining at Luscombe, flourishing exceedingly well, and never having had any protection during the winter, since they were planted in the open air. The largest of the plants at Luscombe is 3 ft. 10 in. high, and the branches cover a space 4 ft. 3 in. in diameter. All the plants are very thickly furnished with side branches quite close to the ground, forming, at a distance, very handsome green bushes. — *R. S. Luscombe, Nov. 6. 1837.*" It thus appears that the *Abies cephalonica* was introduced into England by General Charles James Napier in 1824, though it never was heard of in any public collection, or in the nurseries, till within the last two or three years.

The plant sent to the Plymouth Nursery was, in 1837, sold to the Duke of Bedford for 25 guineas. Two of those sent to the Exeter Nursery were sold to the Rev. Theodore Williams of Hendon Rectory, for about the same sum each; and the third is retained as a stock plant to propagate from.

The seeds sent to Hampton Lodge were safely received, and vegetated without difficulty. Mr. Long, in a letter dated Dec. 3. 1837, says:—"I lost a great number of plants by spring frosts and by rabbits, owing to want of care whilst I was on the Continent. I have only three plants left; and they are in full vigour, and have made shoots, during the past summer, from 6 in. to 7 in. in length." The highest plant is 3 ft., and the breadth of space covered by its branches is 4 ft. in diameter. "I gave some plants to Lord Orford, for his pinarium at Wolterton, in Norfolk; some to Lord King, for his collection at Ockham Park, Surrey; two to Robert Mangles, Esq., of Sunninghill; three I have planted out myself; and the remainder I gave this year to Mr. Penny, the nursery-gardener at Milford." We are thus enabled to account for all the plants raised from the seeds sent home by General Napier.

Properties, Uses, Propagation, &c. The timber of this tree is said to be very hard, and of great durability. General Napier informs us that, in pulling down some old houses in the town of Argostoli, which had been built from 150 to 300 years before, all the wood-work of the Black Forest fir was as hard as oak, and perfectly sound. In Britain, the tree may be considered as one of the most interesting and beautiful of the *Abiétinæ*; and, when it attains the

dimensions of our cedars of Lebanon, which there is no reason to suppose it will not do in favourable situations, its timber may probably be found as useful here as it was in Cephalonia. Should, however, its timber be of no more use than that of the cedar of Lebanon, it is still in every way as worthy of being planted as an ornamental object as that fine tree. As the plant strikes with great readiness by cuttings, a number have been propagated in the Devonshire nurseries, and also in the neighbourhood of London. There are plants in the pinetum at Dropmore, and in the garden of Robert Mangles, Esq., of Sunninghill. The large plants at Hendon Rectory, and in the pinetum at Woburn Abbey, are upwards of 3 ft. high; but the one at Dropmore is only about 18 in. high. Price of plants, in the British nurseries, 2 guineas each.

App. i. *Species of A'bies of which little more is known than their Names.*

A. obovata D. Don MS., *Picea obovata* Led. *Icon. Pl. Fl. Ross.*, t. 500. Leaves arranged in many series, curved upwards. Cones erect, cylindrical. Scales abruptly dilated at the cuneate base into a quadrangular lamina, broader towards the point. Bractees somewhat quadrangular, mucronate, not half the length of the scale, scarcely broader than the wing of the fruit, which is straight on both margins towards the apex. Found on the Altai Mountains, at an elevation of 5278 ft. Flowering in May; not yet introduced. Professor Don informs us, that he strongly suspects this tree to be only a northern form of *A'bies Smithiana*. Ledebour, he says, has committed the same error in regard to his *P. obovata*, as Dr. Wallich did in the case of *A'bies Smithiana*; that is, he has described the cones as erect, while, from the other parts of his description, it must belong to *A'bies*.

A. Mertensiana Bong. and *A. stichensis* Bong. are mentioned by M. Bongard in his observations on the Island of Sitcha, on the west coast of North America, in n. lat. 57°, as indigenous there. The article is quoted in the *Annales des Sciences Naturelles*, 2d ser., tom. iii. p. 237.; but no description is given. *A. trigona*, *A. heterophylla*, *A. aromatica*, *A. microphylla*, *A. obliquata*, and *A. falcata* are mentioned by Rafinesque as being found in the Oregon country; but, as he gives no description of these trees, it is uncertain whether they belong to *A'bies* or *Picea*. The same observations will apply to *A. hirtella* Humboldt et Kunth Nov. Gen. et Sp. Plant., pl. 2. p. 5., of which nothing is known either of the flowers or cones; and *A. Kämpferii* and *A. Thunbergii*, mentioned by Thunberg; and *A. Mörri*, *A. Torano*, and *A. Araragi*, enumerated by Siebold in *Verhand. Batav. Genootsch.*, xii. p. 12., as quoted in *Pen. Cyc.*

GENUS III.



PICEA D. Don. THE SILVER FIR. *Linn. Syst. Monœcia Monadelphica.*

Identification. D. Don in Lamb. Pin., vol. 3.

Synonymes. *Pinus* Lin., in part; *A'bies* Link, Nees von Esenbeck, and Ledebour; *A'bies Du Roi*, in part; *Sapin*, Fr.; *Tannen*, Ger.

Derivation. From *pis*, pitch; the tree producing abundance of resin. Loiseleur Deslongchamps observes that the silver fir was called by the ancients *Abies*, and the spruce *Picea*; and that Linnæus has created much confusion by reversing the application of the names. He proposes, therefore, to call the silver fir *A'bies vera*, and the spruce fir *A'bies Picea*. (*N. Du Ham.*, v. 214. note.) Link has divided the spruces and silver firs into two genera, and given the classical names of *Picea* to the first genus, and *A'bies* to the second (see *Abhand. Akad. der Wissenschaften*, jahr 1827, p. 157.); and in this he has been followed by Nees von Esenbeck, and Ledebour.

Description. Trees remarkable for the regularity and symmetry of their pyramidal heads; readily distinguished from the genus *A'bies*, by their leaves being more decidedly in two rows; by their cones being upright, and having the scales deciduous; and by the seeds being irregular in form. The nucleus of the seed is exposed at the inner angle, through a considerable opening in the outer testa, as if the junction of the two sides had been ruptured by the rapid enlargement of the nucleus. (*D. Don.*) They are natives of Europe, Asia, and America; but, generally, in regions more temperate than those in which the species of spruce abound. In Britain, with the exception of *P. pectinata*, they are solely to be considered as ornamental trees.

‡ 1. *P. PECTINATA*. The comb-like-leaved Silver Fir.

Synonymes. *A'bies* of Pliny; *Pinus Picea* Lin. *Sp. Pl.*, 1420. *Syst.*, ed. Reich., 4. p. 175., *Huds. Angl.*, p. 423., *Scop. Cirm.*, No. 1193., *Pall. Fl. Ross.*, 1. p. 7., *Allon. Fl. Ped.*, 2. p. 179., *Vul. Dauph.*, 3. p. 805., *Ait. Hort. Kew.*, 3. p. 370., *Willd. Berl. Baumz.*, p. 217., *Hayne Dend.*, p. 176., *Hüss Anlett.*, p. 17., *Lamb. Pin.*, ed. 2., 1. t. 40., *Hat. Heil.*, No. 1517.; *P. A'bies Du Roi Harbk.*, ed. Pott., t. 2. p. 133., *Rett. und Abel. Abb.*, t. 98.; *A'bies alba* Mi l. *Dict.*, No. 1., *Lm. Hort. Cliff.*, p. 449.; *A. Taxii folio* Tourn. *Inst.*, p. 585., *Du Ham. Ar.*, 1. p. 3., *Eauh. Pin.*

505; *A. vulgaris* Poir. *Dict. Encyc.*, 6. p. 514.; *A. pectinata* Dec. *Fl. Fr.*, 2. p. 375., *N. Du Ham.*, 5. p. 294.; *A. taxifolia* Hort. *Par.*; *A. Picea* Lindl. in *Penn. Cyc.*, No. 1.; *A. excelsa* Link *Abhand.*, &c., Jahr 1827, p. 182.; Spanish Fir; Sapin commun, Sapin à Feuilles d'If, Sapin blanc, Sapin argenté, Sapin en Peigne, Sapin de Normandie, Fr.; weisse Tanne, Edelkranz, Ger. *Engravings.* Lamb. Pin., ed. 2., 1. t. 40; *Nov. Act. Acad. Nat. Cur.*, 3.; *App.*, t. 13. f. 29. 44.; *Pall. Ross.*, 1. t. 1. f. F.; *Woodv. Med. Bot.*, t. 209.; *Reit. und Abel Abb.*, t. 98.; *N. Du Ham.*, 5. t. 62.; our *fig.* 2237. of the natural size, and *fig.* 2238. to our usual scale; and the plates of this species in our last Volume.

Spec. Char., &c. Leaves solitary, flat, obtuse; 2-ranked, with their points turned up. Cones axillary, cylindrical, erect; scales with a long dorsal bractea. Anthers with a short crest, with two teeth. (*Lois.*) Buds short, egg-shaped, blunt; of a reddish yellow, with from 16 to 20 blunt scales. Leaves from $\frac{1}{2}$ in. to 1 in. long, stiff, turned up at the points; of a shining dark green above, and with two lines of silvery white on each side of the midrib beneath. Cones from 6 in. to 8 in. long, and from $1\frac{1}{2}$ in. to 2 in. broad; cylindrical; green when young, afterwards reddish, and, when ripe, brown. Scale $\frac{1}{2}$ in. to $1\frac{1}{4}$ in. long, and $1\frac{1}{4}$ in. broad. Seeds variously angular, $\frac{2}{3}$ in. long, and $\frac{1}{8}$ in. broad. Cotyledons 5. The blossoms appear in May, and the cones are matured in the October of the following year.

Varieties.

1 *P. p. 2 tortuosa* Booth has the branches and branchlets remarkably twisted or crooked. There is a plant in Messrs. Loddiges's arboretum 3 ft. high.

2 *P. p. 3 foliis variegatis* has the leaves variegated. There is a fine plant of this variety, about 4 ft. high, in the collection of the Rev. Theodore Williams, at Hendon; and the lower branch of a large tree at White

Knights has become variegated, from which we have brought cuttings, and presented them to the Horticultural Society, and to the Hammersmith and Fulham Nurseries.

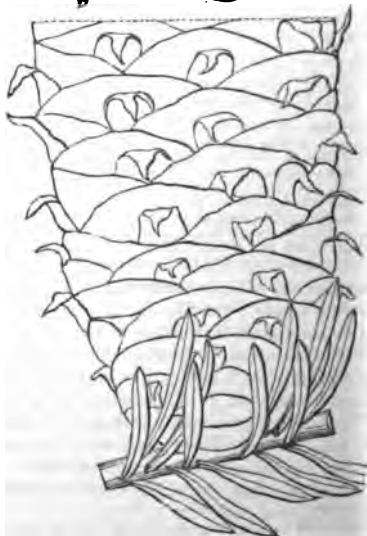
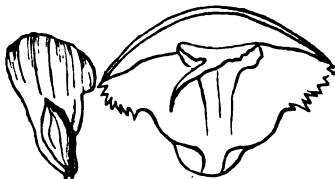

† *P. p. 4 cinerea*, *Pinus Picea cinerea* *Baum. Cat.*, ed. 1835, is a low plant with greyish bark, not yet introduced.

Description. The silver fir, the noblest tree of its genus, except *P. Webbiana*, rises to the height of from 160 ft. to 180 ft., with an erect stem, regularly furnished with whorls of candelabrum-like branches. The trunk, in full-grown trees, is from 6 ft. to 8 ft. in diameter, covered, till its fortieth or fiftieth year, with a whitish grey bark, tolerably smooth; but, as it increases in age, becoming cracked and chapped. At a still greater age, the bark begins to scale off in large pieces, leaving the trunk of a dark brown colour beneath. The branches stand out horizontally, as do the branchlets and spray, with reference to the main stem of the branch. The leaves, on young trees, are distinctly two-rowed, and the general surface of the rows is flat; but, as the trees advance in age, and especially on cone-bearing shoots, the disposition of the leaves in rows is less perfect. The leaves are, in every stage of the tree's growth, turned up at the points; but more especially so on old trees, and on cone-bearing branches. The leaves are of a darker green above than those of any other fir; and underneath they have two white silvery lines running lengthwise on each side of the midrib. As the leaves are partially turned up, these silvery lines make a conspicuous appearance in the general aspect of the tree; whence its name. The cones are large, and have a magnificent appearance, both before and after they are mature. They are cylindrical, erect, and bluntly pointed at both ends. When nearly full grown, the scales are of a fine red; and the bracteas are long, and of a light green. The seeds are of an irregular form, enveloped and surmounted with a membranaceous wing, somewhat broader above than below. The roots spread horizontally, not so near the surface as in the spruce fir. They extend to a great distance, and are not so abundantly furnished with fibres as in the case of most of the spruces, nor have they a conspicuous taproot, as is the case, more or less, with all the genus *Pinus*. The rate of growth of the tree is slow when young, but rapid after it has attained the age of 10 or 12 years. The following scale of the progress of the silver fir in the Jura, in France, is given by Baudrillart; but its growth in England is much more rapid. The first year, it rises in five or six weeks after it has been sown, with five or six leaves, and is about $\frac{1}{2}$ in. in height. The second year, it advances 1 in., retaining the leaves of the first year. The third year, it advances from 1 in. to 2 in., indicating the rudiment of a small lateral branch. The fourth year, it advances about 2 in., showing a second lateral branch; and, if taken up at this time, the plant will be found to have a small taproot. The fifth year, it begins to grow somewhat more freely, but still so slowly, that, unless under very favourable circumstances, the plants are seldom found, at that age, above 9 in. or 1 ft. in height. About the eighth year, they begin to increase more rapidly; gradually lengthening the annual growth of the leading shoot, till, at their 20th year, it is from 2 ft. to 3 ft. in length. Cones with fertile seeds are seldom produced before the tree has attained its 40th year; though cones without seeds often appear before half that period has elapsed. The female catkins are often produced for years together, without any males appearing on the same tree. In the Jura, a silver fir, at the age of 20 years, is commonly from 9 ft. to 10 ft. in height, with a trunk from 12 in. to 1 ft. 4 in. in circumference. After this, it increases in height at the rate of from 1 ft. 8. in. to 2 ft. 2 in. a year. At 40 years' growth, the trunk is from 3 ft. to 3 ft. 6 in. in circumference; at 50 years, from 4 ft. to 5 ft.; at 60 years, from 6 ft. to 8 ft.; at 75 years, from 10 ft. to 11 ft. 6 in.; and, at 100 years, about 13 ft. From 100 to 120 years' growth is necessary to produce a tree of from 114 ft. to 130 ft. in height: after which period, it



scarcely grows higher, but continues to increase slowly in thickness till it has attained the age of 150 years; when it begins slowly to decay. The rate at which the tree tapers, in the Jura, is about 1 in. in 6 ft.; so that a trunk 60 ft. high, and 6 ft. in diameter at the lower end, would be 5 ft. 2 in. at the upper end. In England, in favourable situations, the growth of the silver fir seems to be at least twice as rapid as in the Jura; but it is apt to lose its leader by very severe spring frosts; and, hence, we frequently find old silver firs with forked trunks and branchy heads. Even young plants in the nurseries are apt to lose their leaders from the same cause; for which reason, in the Goldworth and Knaphill Nurseries, in Surrey, the common silver fir and the balm of Gilead silver fir are always sown and transplanted under a spreading deciduous tree; most commonly the apple or pear. The silver fir does not bear the knife, and cannot be made into hedges, like the spruce; but, after it has attained 20 or 30 years' growth, the lower branches may be cut off to a considerable height up the trunk, with advantage to the progress of the head. A silver fir, planted when two years old, at Harefield Park, in Middlesex, in 1603, which was one of the first planted in England, was in 1679, according to Evelyn, 81 ft. high, though forked at the top; and the girth, a little above the ground, was 13 ft. The quantity of timber in the trunk of this tree was estimated at 140 ft. In Ireland, Lord Farnham had many silver firs of 40 years' growth, which had trunks 12 ft. in circumference at the ground; and one still thicker, which contained 76 ft. of solid timber. In the Park at Woburn Abbey, there is a tree which, on the 1st of February, 1837, was exactly 114 ft. high, with a trunk 11 ft. 1 in. in circumference at 4 ft. from the ground. This tree was measured eight years before (viz. in 1829); and its increase during this short period was, in height, 4 ft.; in circumference, 7 in.; in cubic feet of timber in the trunk, 11 ft.; and in cubic feet of timber in the branches, 24 ft. The total amount of available timber in the trunk of this tree, on the 1st of February, 1837, was 210½ cubic feet; and in the larger branches, 139 ft. 6 in.; making a total of 350 cubic feet of marketable timber, exclusive of 20 ft. of forked head. The age of this tree was probably not much above 100 years, as most of the old pine and fir trees at Woburn are said to have been planted in the time of Miller. The loftiest silver fir in England is believed to be a tree at Longleat, which, in 1834, being then 180 years planted, was 138 ft. high, the diameter of the trunk 5 ft. 8 in., and of the head 44 ft. The largest tree in Scotland is supposed to be one at Roseneath, 124 ft. high; the most remarkable one is also at Roseneath, of which a portrait was published by Mr. Strutt, in his *Sylva Britannica*, and of which *fig. 2239.* is a copy, reduced to the scale of 1 in. to 50 ft. This tree, we were informed by Lord Frederick Campbell, in 1835, was then in much the same state in which it was when Mr. Strutt made his drawing, about 1829: it was at that time 90 ft. high; the diameter of the trunk, at 1 ft. from the ground, was 7 ft. 7 in.; and the diameter of the head was 66 ft. Its solid contents were estimated at 619 cubic feet 10 in.; and it was supposed to be 200 years old. The largest tree in the neighbourhood of London is one at Whitton, planted by the Duke of Argyll, probably about 1720, which, in 1837, was 97 ft. high, with a trunk 3 ft. 9 in. in diameter. In the immediate environs of London, the tree does not thrive; nevertheless, we found in the Layton Nursery the young tree figured in our last Volume, which had attained the height of 22 ft. in about 15 years. The silver fir ripens its seeds freely both in England and Scotland. In the woods at White Knights, wherever there are old silver firs, there are numerous young plants arising around them from self-sown seeds.



One of the most remarkable circumstances connected with the silver fir is, the vitality of the stump for many years after the tree has been cut down. As far as we are aware, this was first noticed by Loiseleur Deslongchamps, in the *Nouveau Du Hamel*, v. p. 316.; where he says, speaking both of the silver fir and the spruce, that, after being cut down, the stump vegetates for some time; its external ligneous layers increase with the liber, and endeavour, by forming a callosity inwards, to cover the section of the stump. M. Dutrochet had observed this process taking place on the stumps of the silver fir in the Jura, in 1833; and he procured, in 1805, several stumps from the Jura forests, which were in a living state when taken up. One of these was the stump of a silver fir felled in 1821, which had thus been increasing in diameter during 14 years; the new wood and bark being easily distinguishable from the former wood and bark, which were in a state of incipient decomposition. The total thickness of the 14 layers of this new ligneous production was 5·669 lines (nearly $\frac{1}{2}$ in.) in the vertical part of the stump; and this thickness is increased to 8·032 ($\frac{3}{4}$ in.) in the ligneous part of the callosity (*bourellet*) protruded over a part of the section made by the axe. Another stump was that of a tree felled in 1743; and it was still full of life when examined at the end of the year 1836. The wood formed since the tree was felled consisted of 92 layers, the total thickness of which was nearly 2 in. The wood of which the stump was composed when the tree was felled had entirely disappeared; and the thick rind, or callosity, which had formed round the margin had curled over so as almost to cover the top of the stump. This stump, which had lived and increased in diameter during 92 years, would, in all probability, have endured much longer; so that we are ignorant how far this singular prolongation of life and increase of growth may extend, in stumps deprived of their trunk and leaves, and which only receive nourishment from the roots. (*Gard. Mag.*, vol. xiii. p. 93.)

Geography. The silver fir is indigenous to the mountains of Central Europe, and of the west and north of Asia, rising to the commencement of the zone of the Scotch pine. It is found in France, on the Pyrenees, the Alps, and the Vosges; in Italy, in Spain, and Greece in the south of Germany; and Russia, and in Siberia; but it is not found in Sweden or in Scotland. On the Carpathian Mountains, it is found to the height of 3200 ft.; and on the Alps, to the height of from 3000 ft. to 4000 ft. It attains a large size in the narrow valleys between the Swiss mountains; in the Black Forest in the south of Germany; and on the Pollino, and in the Forest of Rubia, in the kingdom of Naples. According to Pallas, it is common in Caucasus, the Uralian, Altaic, and Baikal Mountains, growing in the clefts of the rocks; but it is seldom found in the plains. The trees on Caucasus have the branches more elongated and slender, and the leaves more thinly scattered, broader, and more emarginate, than the trees of Siberia; these last being, in all probability, the *Abies Pichta* of Fischer. Wherever it is found attaining a large size, it invariably grows in good soil, and in a situation sheltered rather than exposed. In Germany, in the neighbourhood of Darmstadt, Baden, and Donaueschingen, in the Black Forest, it is found growing among oaks and other trees, in deep loamy soil, moist rather than dry; attaining the height of from 80 ft. to 100 ft., with trunks from 16 ft. to 20 ft. in circumference at 6 ft. from the ground. In the neighbourhood of Strasburg, and in the Vosges, where it has attained the height of 150 ft., the situation has always been low and sheltered, and the soil a deep loam.

History. Some confusion exists in the works of modern authors respecting the silver fir and the spruce; partly, as it would appear, from the circumstance of Linnæus having made an erroneous application of the names given to these trees by Pliny. The tree which Theophrastus calls *Elatē*, Pliny calls *Abies*, and Linnæus *Pinus Picea*; while the tree that Pliny calls *Picea*, and which is our spruce fir, is named by Linnæus *P. Abies*. The silver fir was esteemed by the Romans for its use in carpentry, and for the construction of vessels; and hence Virgil's expression, —

"Casus abies visura marinos."

Georg., ii. 68.

The fir about to brave the dangers of the sea.

And in Claudian, —

"Apta fretis abies."

The fir useful in ship-building.

In the *Eclogues*, Virgil says, alluding to the situations in which it grows, —

—— "Pulcherrima abies in montibus altis."

Ecl., vii. 66.

The abies is the most beautiful tree on lofty mountains.

In the *Æneid* he says, —

—— "Undique colles

Inclusere cavi, et nigra nemus abiete cingunt."

Æn., viii. 529.

"Hills clad with fir, to guard the hallow'd bound,
Rise in the majesty of darkness round."

Pitt's trans.

The wood was employed by the ancients for many different purposes. Pliny speaks of it in several places. It is preferred to that of the larch, he says, for the masts of vessels, on account of its lightness. In his 16th book, he speaks of a silver fir that formed the mast of a vessel on board which the Emperor Caligula had an obelisk transported from Egypt to Rome. This mast required the outstretched arms of four men to encircle it, and cost 80,000 sesterces, or about 30*l*. The Romans employed the silver fir for javelins, as appears by the following lines from Virgil: —

—— "Cujus apertum

Adversâ longâ transverberat abiete pectus."

Æn., xi. 656.

Whose breast exposed the long fir spear transpierced.

The resinous products of the silver fir were also well known to Theophrastus and Pliny, who both detail the modes practised by the Greeks and Romans in preparing pitch and tar, which scarcely differ at all from those in common use at the present day.

The silver fir was introduced into England in the seventeenth century; but the precise period is not known. Plot and Ray mention some trees growing near Newport in Shropshire; and Evelyn speaks of two Spanish or silver firs growing in Harefield Park, Middlesex, that were planted there in 1603, at two years' growth from the seed. The tree was strongly recommended by Evelyn for its beauty, and its fitness to adorn walks and avenues; and it has, accordingly, been very generally planted for ornamental purposes. In 1797, the Society of Arts gave their gold medal to Henry Vernon, Esq., of Hilton Park, near Wolverhampton, for having planted upwards of 6000 silver firs. As this tree ripens seeds freely, it is now common in the nurseries, and very generally introduced into plantations, especially such as are ornamental; and, in grounds laid out before the middle of the eighteenth century, it may be seen near mansions, rearing its fine pyramidal head above all other trees.

Properties and Uses. The wood of the silver fir is elastic, and the colour is whitish. The grain is irregular, as the fibres which compose it are partly white and tender, and partly yellow, or fawn-coloured, and hard. The narrower the white lines are, the more beautiful and solid is the grain of the wood. In the Vosges, it is said that the external layers are more compact than the internal ones; which may arise from the practice of barking the trees there before they are cut down. The weight of this wood varies exceedingly, according to the age of the tree, the place where it grew, and even the part of the trunk from which it was taken. According to Hartig, the wood of a tree 80 years old weighs 66 lb. 14 oz. per cubic foot green, and 41 lb. 5 oz. when dry; while that of a tree 40 years old weighs only 37 lb. 9 oz. when dry. It shrinks considerably in drying, like all white woods. It is used for planks, and carpentry of all kinds; for the masts of small vessels; for joists and rafters; and for building the boats used for navigating rivers. It is said to endure a long time when used as piles, and to be much employed in Hol-

land for that purpose. In the Vosges, it is used in every department of agriculture, carpentry, joinery, and even cabinet-making and sculpture. In England, the wood of the silver fir has been chiefly used for flooring; and, according to Arthur Young, and also to Mitchell, boards sawn out of full-grown trees may be laid down at once, without any risk of their shrinking. (See *Young's Tour in Ireland*, vol. i. p. 245., and *Mûch. Dend.*, p. 270.) As fuel, the wood of the silver fir is to that of the beech as 1079 is to 1540; and to that of the spruce, as 1079 is to 1211. The charcoal is to that of the beech as 1127 is 1600. Though the charcoal is much inferior to that of the beech, yet it is preferred for heating iron that is to be forged; as producing the heat more slowly, in consequence of which the iron is more pliant to work. The bark may be employed for tanning leather, and is used generally in some parts of Switzerland. A resinous sap flows from the trunk and branches, called *larmes de sapin*. This sap is bitter, acrid, and viscous; and its smell approaches to that of the citron: it is healing, balsamic, and antiseptic. The resinous fluid is found in small tumours or blisters, under the epidermis of the bark; and in the green cones, from the latter of which it is collected about midsummer. From the resin of this tree are manufactured Strasburg turpentine (so called from a large forest of silver firs, the Hochwald, near Strasburg), colophony, and white pitch. The quantity of potash furnished by the bark and wood is in the proportion of 2 lb. of potash to 1000 lb. of wood and bark; which places the silver fir in the rank of 21 in a series of 73 ligneous plants. In some parts of Europe, the young cones, reduced by boiling to a pulp, and preserved with sugar, are eaten as a sweetmeat. This conserve is put into tea, to which it is said to communicate an agreeable odour. The leaves serve for litter; and, in Switzerland, according to Kasthoffer, are given to sheep and goats; but they are said to give the milk a peculiar taste.

Mode of extracting and preparing the Strasburg Turpentine. Every year, about the month of August, the Italian peasants who live near the Alps make a journey into the mountains to collect the turpentine. They carry in their hands cornets of tin, terminating in a sharp point, and a bottle of the same metal suspended to the girdle round their waists. Some use bullocks' horns instead of vessels of tin. Thus accoutred, the peasants climb to the summits of the loftiest silver firs; their shoes being armed with cramping-irons, like spurs, which enter into the bark of the trees, and thus support the climber; who also clings to the trunk of the tree with his knees, and one arm, while with the other hand he presses his cornet to the little tumours, or bladders, which he finds in the bark, to extract the turpentine within them. As soon as a cornet is filled with the clear turpentine which flows from the tumour, or blister, on the tree, it is emptied into the tin bottle, which is carried suspended from the waist; and, when this bottle is full, its contents are strained into a large leathern bottle, or goatskin. The straining is to free the turpentine from the leaves, and bits of bark and moss, which may have fallen into the contents; and this is the only preparation that is given to this kind of turpentine, which is kept in the goatskins, or leathern bottles for sale. Besides the turpentine collected from the tumours, or blisters, an inferior kind is produced by slightly wounding the bark of the tree. In rich soils, the trees will yield their sap twice a year, viz. in spring and August; but, in general, the tumours, or vesicles, form only once a year, viz. in spring, and are full of turpentine in August. The tumours are sometimes round, and sometimes oval; but, when the latter, their greatest length is always in a horizontal direction. Good Strasburg turpentine ought to be clear, free from impurities, transparent, and of the consistence of syrup, with a strong resinous smell, and rather a bitter taste. It is employed, as well as the essential oil of turpentine which is distilled from it, both in medicine and the arts; being found superior to all the other substitutes for the turpentine of *Pistacia Terebinthus*. It is the only kind of turpentine, produced by any kind of pine or fir tree, which is used in the preparation of the clear varnishes, and by artists

for their colours ; and its oil sells it a higher price than any other. It is distilled with water, in the same manner as the other kinds of turpentine, and the residuum is a kind of colophony ; a name applied to black resin, because a natural hard resin, sometimes used in plasters, and said to be the product of the *Dámara orientális*, which is mentioned by Dioscorides, was brought from Colophon, in Ionia. The proportions for making oil of turpentine from the Strasburg turpentine are, 5 lb. of liquid resinous juice to 4 pints of water, distilled in a copper alembic. This is the essential oil of turpentine ; and, if 1 lb. of it be redistilled with 4 pints of water, it is called rectified or ætherial oil of turpentine. Both preparations are used, in small doses, as diuretics, and in cases of rheumatism ; they are also considered powerful styptics. In farriery, the essential oil of turpentine is much used for strains and bruises, and is found very efficacious.

The Silver Fir in British Plantations. Though the silver fir has been planted in some instances, in Britain, in masses, with a view to producing timber, yet its principal use has been as an ornamental tree. Before the cedar of Lebanon became so common, or was known to be so hardy as it has been since found to be, the silver fir was planted near mansions, as a choice and a striking tree, which, as the cedar does now, might distinguish the residence of the large landed proprietor from those of his more humble neighbours. This it did, not only by raising its pyramidal head above all other trees, but by its striking regularity of form, fine dark green foliage, and candelabrum-like regular tiers of branches. This regularity of form was, of course, objected to by the admirers of the picturesque. Gilpin says : " The silver fir has very little to boast in point of picturesque beauty. It has all the regularity of the spruce, but without its floating foliage. There is a sort of harsh, stiff, unbending formality in the stem, the branches, and in the whole economy of the tree, which makes it disagreeable. We rarely see it, even in its happiest state, assume a picturesque shape. Assisted it may be in its form, when broken and shattered, but it will rarely get rid of its formality. In old age, it stands the best chance of attaining beauty. We sometimes see it, under that circumstance, a noble shattered tree, finely adorned with ivy, and shooting out a few horizontal branches, on which its meagre foliage and tufted moss appear to advantage. I may add that the silver fir is, perhaps, the hardiest of its tribe. It will out-face the south-west wind ; it will bear, without shrinking, even the sea air : so that one advantage, at least, attends a plantation of silver firs ; you may have it where you can have no other ; and a plantation of silver firs may be better than no plantation at all." (*For. Scen.*, i. p. 90.) " As to the picturesque effect of this tree," Sir Thomas Dick Lauder observes, " we have seen many of them throw out branches from near the very root, that twined and swept away from them in so bold a manner, as to give them, in a very great degree, that character which is most capable of engaging the interest of the artist." (*Laud. Gilp.*, i. p. 180.) The advantage of planting the silver fir, in preference to the spruce, on stiff soils, Mr. Curtis of Glazenwood observes, is that the one advances to a large timber tree, while the other stops at 20 ft. or 30 ft. high, and becomes rusty and stunted. There are, in Essex, in the neighbourhood of Glazenwood, silver firs of 100 ft. high, on soils in which the spruce would not have attained half that height.

Soil, Situation, &c. The silver fir, like all the other *Abiétinæ*, will attain a large size on soils of a very opposite description ; but a loam, rather rich and deep than otherwise, appears to suit it best. It has attained its greatest height, in soils of this description, at Studley and Castle Howard ; but it has also attained a very great height in sandy loam at Woburn Abbey, and on clay, incumbent on a retentive clayey subsoil, at Panmure. It is in vain, says Boucher, to plant silver firs in hot, dry, or rocky situations, where they commonly not only lose their top shoots, but their under branches soon become ragged ; and, in place of that lively shining verdure peculiar to them in a suitable soil, they become of a pale languid hue ; nay, he adds, " I have known trees of them about twenty years planted out in such soils, entirely destroyed

by a hot dry summer. At the same time, they are, in other respects, amongst the least delicate of any plants in the choice of their food; as the largest and most flourishing trees of them I have ever seen, over the island, in general grow on sour, heavy, obstinate clay, of all different qualities and colours; and though for ten or twelve years, they do not advance so fast as several of the other pines and firs, yet in twenty years they will outgrow them all, and continue that advantage till they arrive to their greatest magnitude." The silver fir requires a low situation, comparatively with the spruce fir, not being nearly so hardy as that tree, either when in the nursery or full grown. The cones, which are apt to shed their seeds in spring, ought to be gathered in October or November, and kept in a dry place till the sowing season. The seeds may be easily separated from them by a very slight exposure to the sun, and then by thrashing them, without having recourse to the kiln. The seeds should be sown, according to Sang, in March, and at such a distance as to allow the plants to rise 1 in. apart; and the covering, he says, should be a full inch thick. When the plants are 2 years old, they may be transplanted into nursery lines; and, after being 2 years in that situation, they may either be again transplanted in the nursery, to a greater distance apart, or removed to where they are finally to remain.

Accidents, Diseases, &c. The silver fir suffers more from extreme drought than any other species of the pine and fir tribe; whole forests being occasionally destroyed in this way in the north of France and in Switzerland. When the trees are young, they are liable to have their leading shoot injured by the frost; but this is not the case after the plants have attained the height of 5 ft. or 6 ft. The tree suffers from various insects, as has been already noticed in our general introduction, p. 2139.

Statistics. Recorded Trees. The two trees at Harefield Park, planted in 1603, and one of which, in 1678, was 81 ft. high, and contained 146 ft. of good timber, have been already mentioned. Mitchell mentions scores of trees at Wardour Castle, "whose aspiring heads," he says, were far advanced beyond all other trees there." At Longleat, he mentions a grove of 16 trees, 23 ft. apart, 110 ft. high, and from 10 ft. to 13 ft. in circumference. Each tree contained upwards of 300 ft. of timber. At the above distance of 22 ft., this would give 90 trees per acre, or 360 loads of timber; which, at the very moderate price of 3*l.* a load, is 1080*l.* In 1813, Mitchell felled three silver firs, which were planted in 1786: they stood in a line, 15 ft. apart, and were from 100 ft. to 112 ft. high. Each tree had lost its leader at 40 ft. high, and had formed a branchy head. The first tree contained 289 ft. of timber; the second 273 ft., and the third, 164 ft. The top (that is, tops and lateral branches) made 288 hevens 2 cords and 88 parts of cordwood. A silver fir at the House of Polkemmet, in West Lothian, measured in October, 1799, was 10 ft. in circumference, at 4 ft. from the ground. One at Binning Wood, 70 years old, was, in 1812, 10 ft. 4 in. in circumference, at 4 ft. from the ground. A silver fir at Drumlanrig Castle, in Nithsdale, was, in 1773, 12 ft. in circumference. One at Woodhouselee, Mid-Lothian, measured in 1793, was 11 ft. 1 in. in girth; and in 1835 it was 14 ft. 10 in. in girth, and 94 ft. high. Under this tree, now in a state of decay, we have often played in our boyish days. A tree in Skyrle, growing on the Martinsberg, in the forest district of Ziri, measured 5 ft. in diameter, at 9 ft. from the ground; and, at a height of between 90 ft. and 95 ft. from the ground, still retained a diameter of between 8 in. and 9 in. (*Handbook for Southern Germany*, p. 322.) In the Museum of Natural History, at Strasburg, is a section of the trunk of a silver fir, cut so as to form a seat, called there *Le grand sapin du Hochwald, à Barr*, département de Bas Rhin. This tree was 150 ft. high, with a trunk straight and clear of branches to the height of 50 ft., at which point it became forked. The diameter of the trunk, at the surface of the ground, was 8 ft.; and, at the height of 50 ft., 5 in. The estimated age of the tree was 360 years. It was cut down on the 16th of June, 1816, the trunk having begun to decay in the centre. We were informed, when we saw this section in 1838, that there was a tree standing very near where this one stood almost as large. The Forest of Hochwald was composed entirely of silver firs, and before the revolution belonged to the town of Strasburg.

Existing Trees. In the environs of London, at Whitton Place, near Twickenham, it is 97 ft. high, with a trunk 3 ft. 9 in. in diameter; at Syon, the tree figured in our last Volume is 96 ft. high.—South of London. In Cornwall, at Carclew, it is 99 ft. high, the diameter of the trunk 3 ft. 9 in., and of the head 30 ft. In Devonshire, at Bilton, 104 ft. high, the diameter of the trunk 3 ft., and of the head 36 ft.; at Luscombe, 21 years planted, it is 37 ft. high; at Bystock Park, 41 years planted, it is 55 ft. high; at Endeleigh Cottage, 23 years planted, it is 65 ft. high. In Hampshire, at Alresford, 81 years planted, it is 63 ft. high, the diameter of the trunk 3 ft.; at East Tytherley, 80 years planted, it is 120 ft. high, the trunk containing 230 cubic feet of timber, the diameter of the head is only 42 ft.; at Strathfeldsaye, it is 120 ft. high, with a trunk 4 ft. 6 in. in diameter. In Kent, at Knowle, 106 ft. high, the diameter of the trunk 4 ft. 10 in., and of the head 187 ft. In Somersetshire, at Kingweston, 104 ft. high, with a trunk 4 ft. 3 in. in diameter. In Surrey, at Bagshot Park, 12 years planted, it is 30 ft. high. In Sussex, at Cowdrey, it is 120 ft. high, with a trunk 4 ft. 6 in. in diameter, clear of branches to the height of 65 ft.; at Kidbrooke, it is 80 ft. high, with a trunk 4 ft. in diameter. In Wiltshire, at Longleat, 180 years old, it is 138 ft. high, the diameter of the trunk 5 ft. 8 in., and of the head 44 ft.; at Wardour Castle, 50 years planted, it is 60 ft. high, the diameter of the trunk 5 ft. 4 in., and of the head 42 ft.; at Longford Castle, it is 60 ft. high, with a trunk 2 ft. in diameter.—North of London. In Bedfordshire, at Woburn Abbey, the tree already mentioned, p. 2332, is 114 ft. high; at Southill, it is 80 ft. high, the diameter of the trunk 3 ft. 4 in., and of the head 54 ft. In Buckinghamshire, at Temple House, 40 years planted, it is 60 ft. high. In Cheshire, at Eaton Hall, 14 years planted, it is 90 ft. high. In Derbyshire, at Kedleston, are several trees, from 130 ft. to 150 ft. high, and girdling from

1 ft. to 16 ft. In Denbighshire, at Llanbede Hall, 45 years planted, it is 50 ft. high. In Durham, at Stanwick Park, is one with a trunk 4 ft. in diameter. In Essex, at Audley End, 60 years planted, it is 50 ft. high, the diameter of the trunk 2 ft., and of the head 24 ft. In Hertfordshire, at Cheshunt, 20 years planted, it is 36 ft. high. In Leicestershire, at Donnington Park, 49 years planted, it is 72 ft. high. In Nottinghamshire, at Clumber Park, it is 80 ft. high, the diameter of the trunk 3 ft. 11 in., and of the head 44 ft. In Northamptonshire, at Wakefield Lodge, 16 years planted, it is 20 ft. high. In Northumberland, at Hartburn, 83 years planted, it is 138 ft. high, the diameter of the trunk 4 ft., and of the head 40 ft.; another is 96 ft. high, the diameter of the trunk 3 ft., and of the head 38 ft. These two trees, on account of being superior in height to all the trees around them, are here called the "Nod Queens." In Oxfordshire, in Tew Park, it is 110 ft. high, the diameter of the trunk 5 ft., and of the head 54 ft. In Radnorshire, at Maeslaugh Castle, it is 68 ft. high, the diameter of the trunk 2 ft. 4 in., and of the head 40 ft. In Shropshire, at Willey Park, 18 years planted, it is 30 ft. high; another, 9 years planted, is 30 ft. high; at Kinlet, 60 years planted, it is 80 ft. high. In Suffolk, at Finborough Hall, 14 years planted, it is 34 ft. high; at Stretton Rectory, it is 90 ft. high, with a trunk 4 ft. 6 in. in diameter. In Warwickshire, at Combe Abbey, 60 years planted, it is 70 ft. high, the diameter of the trunk 3 ft. 6 in., and of the head 80 ft. In Worcestershire, at Croome, 50 years planted, it is 90 ft. high, the diameter of the trunk 2 ft. 4 in., and of the head 40 ft. In Yorkshire, at Castle Howard, it is 130 ft. high, the diameter of the trunk 3 ft. 6 in.; at Sudley, it is 96 ft. 6 in. high, diameter of the trunk 3 ft. 6 in., and of the head 50 ft. In Scotland, near Edinburgh, at Woodhouselee, the tree already mentioned, p. 237; at Hopetoun House, 100 years old, it is 90 ft. high, the diameter of the trunk 3 ft. 7 in., and of the head 45 ft.—South of Edinburgh. In Ayrshire, at Kilkerran, it is 90 ft. high, with a trunk 5 ft. in diameter; at Auchincruive, it is 80 ft. high, with a trunk 3 ft. 6 in. in diameter. In Berwickshire, at the Hirsell, 8 years planted, it is 15 ft. high. In Renfrewshire, at Erskine House, it is 70 ft. high, with a trunk 2 ft. 10 in. in diameter. In Roxburghshire, at Minto, 75 years planted, it is 90 ft. high, the diameter of the trunk 3 ft. 6 in.—North of Edinburgh. In Argyllshire, at Toward Castle, 13 years planted, it is 18 ft. high; at Roseneath Castle, 138 years old, it is 124 ft. high, the diameter of the trunk, at 3 ft. from the ground, 6 ft. 4 in., and of the head 74 ft.; another, of the same age, and about 120 ft. high, has a trunk 7 ft. in diameter at 1 ft. from the ground; there is also the remarkable tree figured in our last Volume. In Banffshire, at Gordon Castle, it is 54 ft. high, the diameter of the trunk 2 ft. 8 in., and of the head 45 ft. In Clackmannanshire, in the Garden of the Dollar Institution, 12 years planted, it is 26 ft. high. In Cromarty, at Coull, it is 70 ft. high, the diameter of the trunk 2 ft. 6 in., and of the head 90 ft. In Forfarshire, at Kinnaird Castle, 80 years planted, it is 85 ft. high, the diameter of the trunk 4 ft., and of the head 50 ft.; at Courtsachy Castle, 102 years old, it is 85 ft. high, the diameter of the trunk 3 ft. 6 in., and of the head 32 ft.; at Gray, there are several specimens 80 ft. high, with trunks nearly 4 ft. in diameter. In Morayshire, at Ballindalloch, are two silver firs, one, 78 ft. high, and 10 ft. 6 in. in girth at 1 ft. from the ground, and 8 ft. 6 in. at 10 ft. from the ground; the other is 96 ft. high, 13 ft. 4 in. in girth at 1 ft. from the ground, and 9 ft. 6 in. at 10 ft. from the ground. In Perthshire, at Dupplin, it is 55 ft. high, with a trunk 5 ft. in diameter; at Taymouth, it is 90 ft. high, the diameter of the trunk 2 ft. 6 in., and of the head 36 ft. In Strathgryshire, at Blair Drummond, 120 years old, it is 90 ft. high, the diameter of the trunk 3 ft., and of the head 36 ft.; at Airthrey, it is 80 ft. high, with a trunk 4 ft. in diameter; at Sauchie, 30 years planted, it is 22 ft. high; in Bannockburn Wood, it is 89 ft. high.

In Ireland. At Dublin, in the Glasnevin Botanic Garden, 35 years planted, it is 40 ft. high. In Kilkenny, at Woodstock, 80 years planted, it is 91 ft. high, the diameter of the trunk 3 ft. 6 in., and of the head 52 ft. In Down, at Mount Stewart, 50 years planted, it is 56 ft. high; at Moira, it is 90 ft. high, the diameter of the trunk 3 ft. 6 in., and of the head 46 ft.; at Tullymore Park, 60 years planted, it is 84 ft. high, the diameter of the trunk 5 ft., and of the head 60 ft.; at Ballyleedy, 60 years planted, it is 52 ft. high. In Fermanagh, at Florence Court, 20 years planted, it is 36 ft. high; at Castle Coole, 50 years planted, it is 80 ft. high, the diameter of the trunk 2 ft. 6 in. In Sligo, at Makree Castle, it is 86 ft. high, and the diameter of the trunk 3 ft. 6 in.

In Foreign Countries. In France, at Colomby, near Metz, 70 years planted, it is 63 ft. high, the diameter of the trunk 2 ft. In Hanover, at Harbcke, 10 years planted, it is 16 ft. high; in the Göttingen Botanical Garden, 40 years planted, it is 50 ft. high. In Bavaria, at Munich, in the English Garden, 50 years planted, it is 70 ft. high. In Prussia, near Berlin, at Sans Souci, 45 years planted, it is 40 ft. high; in the Pfauen Insel, 35 years planted, it is 36 ft. high. In Denmark, at Dronninggaard, 40 years planted, it is 100 ft. high. In Sweden, in the Botanic Garden at Lund, it is 30 ft. high. In Italy, at Monza, 70 years planted, it is 75 ft. high.

Commercial Statistics. Price of seeds, in London, 2s. 6d. per pound: plants, two years' seedlings, are 15s. per 1000; transplanted plants, 6 in. high, 20s. per 1000; from 9 in. to 12 in. high, 30s. per 1000; 1 ft. 6 in. high, 10s. per 100; 2 ft. high, 16s. per 100. At Bollwyller, plants are 3 cents each; *P. cinerea*, 4 francs each. At New York, plants of the species are 75 cents.

‡ 2. *P. (P.) PITCHA.* The Pitch Silver Fir.

Synonymes. *Pinus Pichta* Lodd. Cat., ed. 1836; *P. sibirica* Hort.; *Abies sibirica* Ledebour Icon. Pl. Fl. Ross., t. 499, Lindl. in Penny Cyc., No. 2; *A. Pichta* Fischer; *Pichta*, Russ. Engraving. Led. Icon. Pl. Fl. Ross., t. 499.

Spec. Char., &c. Leaves solitary, tetragonal, dark green. Cones cylindrical, erect. Scales cuculate-ovovate, rounded at the apex, quite entire, convex externally. A native of the Altai Mountains, at an elevation of 4000 ft., where it forms whole forests; towards an elevation of 5272 ft., it gradually becomes more rare. (*Ledeb.*) Introduced in 1820, and differing from a young silver fir, chiefly in having the leaves closer set on the branches, and not so silvery beneath. Professor Don suspects it to be only the Siberian variety of *Picea pectinata*, which ranges from the Atlantic to the Pacific. The tree in the Horticultural Society's Garden was, in 1837, after being 4 years planted, 2 ft. 6 in. high.

‡ 3. *P. BALSAMEA* L. The Balm of Gilead, or American, Silver Fir.

Synonymes. *Pinus balsamea* Lin. *Sp. Pl.*, 1421. *Syst.*, ed. Reich., 4. p. 176., *Smith in Rees's Cyc.*, No. 26., *Gron. Virg.*, 2. p. 152., *Wang. Bet.*, p. 40., *Lamb. Pin.*, ed. 2., t. 41., *Du Roi Harbk.*, ed. Pott., 2. p. 144.; *P. Abies balsamea* Marsh. *Arb. Amer.*, p. 102.; *Abies Txi folio*, &c., *Hort. Angl.*, 2. p. 2., *Du Ham. Arb.*, 1. p. 3., *Pluk. Alm.*, 2. t. 121., *A. balsaminea* N. Du Ham., 5. p. 295.; *A. balsamifera* Michx. N. Amer. *Syl.*, 3. p. 191.; Balsam Fir; le Baume de Giléad, le Sapin Baumier de Giléad, Fr.; Balsam Fichte, Balsam Tanne Ger.

Engravings. *Lamb. Pin.*, ed. 2., 1. t. 41.; *Pluck. Alm.*, 2. t. 121. f. 1.; N. Du Ham., 5. t. 83., f. 2.; Mich. N. Amer. *Syl.*, 3. t. 150.; and our *fig.* 2242. to our usual scale, and *figs.* 2240. and 2241. of the natural size.

Spec. Char., &c. Leaves solitary, silvery beneath, apex emarginate, or entire; somewhat recurved, and spreading. Cones cylindrical, violet-coloured; and pointing upwards. (*Michx.*)

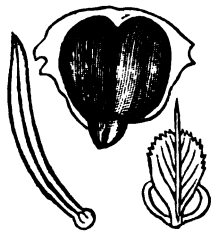

2240

of that of the common silver fir. Cotyledons, 2. A tree, introduced in 1696. In Britain, seldom above 20 ft. high; flowering in May, and ripening its cones in autumn.

Variety.

‡ *P. b. 2 longifolia* Booth has leaves longer than the sheaths, with the branches somewhat more upright.

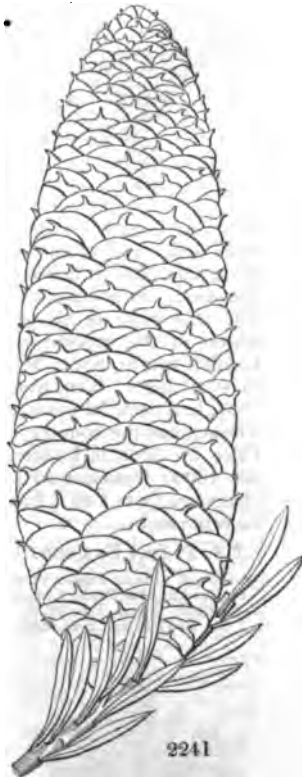

2241

Description, &c. A pyramidal tree, in general appearance resembling the silver fir of Europe; but seldom found, even in America, above 20 ft. or 30 ft. in height, and not of more than the same number of years in duration. The trunk tapers from 1 ft. in diameter at the surface of the ground, to 7 in. or 8 in. at the height of 6 ft. When standing alone, it forms a regular pyramidal head, abundantly furnished with branches and cones. The leaves are 6 or 8 lines long; of a bright but dark green above, and a silvery white beneath. The male catkins are numerous, crowded round the shoots of the preceding season, and more persistent than in the silver fir. The cones are nearly cylindrical, of a darker purple than in the silver fir; 4 in. or 5 in. long, 1 in. in diameter, tapering towards the upper extremity, and generally sprinkled with resin, at least on one side. The bark is thickly interspersed with small vesicles, containing a clear limpid resin. The wood is light, yellowish, and slightly resinous. The rate of growth, in the climate of London, is rather more rapid than that of the silver fir, the tree attaining the height of 10½ ft. in as many years, and arriving at maturity in 20 or 25 years; soon after which it dies, the symptoms of its decay being, as observed in Lawson's *Manual*, an apparent overflow of sap, and an unnatural thickening of the terminal shoots; which may probably arise from the richness of the soil and the warmth of the situation in which the tree is planted. The balm of Gilead fir was cultivated by Bishop Compton in 1697; and its seeds being generally imported, and sometimes ripened, in this country, it is easily procured in



the nurseries, and is frequent in ornamental plantations. The wood is but little employed in America, on account of its deficiency in size and strength; but it is sometimes used for the staves of casks for packing fish. The sap is extracted by means of incisions in the body of the tree, or collected from the exudations which take place on its bark, in the same manner as is done with that of the silver fir. It is sold, in the United States and in England, under the name of balm of Gilead, or Canada balsam; and, combined with spirits, Sir J. E. Smith

observes, it makes a not unpleasant dram. The fresh turpentine is, however, acrid and inflammatory, and, applied to wounds, causes heat and acute pain, though it is considered of great efficacy in certain stages of consumption. It is a greenish transparent fluid, with a very penetrating taste. The true balm of Gilead is produced by the *Amymris gileadensis*. The largest of the specimens of the balm of Gilead fir in the neighbourhood of London are at Syon, Whitton, and Chiswick Villa, where it is from 30 ft. to 40 ft. high. The tree in the Horticultural Society's Garden, which, in 1837, had been 10 years planted, was 10 ft. high, and had produced cones. Throughout the country, there are numerous trees from 25 ft. to 30 ft. high. Price of seeds, in London, 2s. 6d. per oz.: plants, two-years' seedlings, 10s. per 1000; transplanted plants, 8 in. high, 40s. per 1000. At Bollwyller, plants are from 1 to 2 francs each; and at New York, plants 4 ft. high are 75 cents each.

† 4. *P. (B.) FRASERI* Pursh. *Fraser's, or the double Balsam, Silver Fir.*

Synonymes. *Pinus Fraseri* Pursh Fl. Amer. Sept., 2. p. 639, Lamb. Pin., ed. 2., 1. t. 42; *A. Fraseri* Lindl. in Penny Cyc., No. 5.

Engravings. Lamb. Pin., ed. 2., 1. t. 42.; and our *figs.* 2243, 2244.

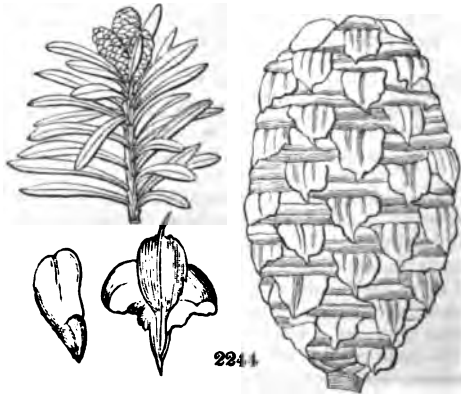

Spec. Char., &c. Leaves linear, emarginate, silvery beneath. Cones oblong, squarrose. Bracteoles somewhat leafy, obcordate, mucronate, half exserted, reflexed. (*Don* in *Lamb. Pin.*) This tree so closely resembles the preceding kind, that it is unnecessary to describe it. It is not noticed by Michaux; but Pursh found it on high mountains in Carolina, resembling, he says, *P. balsamea* in several respects, but differing, at first sight, in being a smaller tree, the leaves shorter and more erect, and the cones not one fourth the size. It was introduced into England by Mr. Fraser, in 1811; and the original tree is in the Hammersmith Nursery, where, in 1837, it was 15 ft. high, and had, for two or three years, produced cones, but no male catkins. This last circumstance has given rise to the idea that the male and female are produced by different trees, which is exceedingly improbable. There are two plants in the Horticultural Society's Garden: one, considered the male, in 1837, after being 3 years planted, was 2 ft. high; and the other,

supposed to be the female, of the same age, was 4 ft. high. Plants, in the London nurseries, are 5s. each; and at Bollwyller, 3 francs.

‡ 5. *P. GRANDIS* Dougl. The great Silver Fir.

Synonymes. *Pinus grandis* Dougl. MS., *Lamb. Pin.*, 3. t. 94.; *Abies grandis* Lindl. in *Penny Cycl.*, No. 3.; the great Californian Fir.

Engraving. *Lamb. Pin.*, 3. t. 94.; our *fig. 2245* from Lambert's *Pinus*, vol. iii., and *fig. 2246*, from Douglas's specimens in the herbarium of the Horticultural Society, and the tree in the garden.

Spec. Char., &c. Leaves flat, obtuse, emarginate, pectinate, silvery beneath. Cones cylindrical; bracteoles ovate, acuminate, irregu-

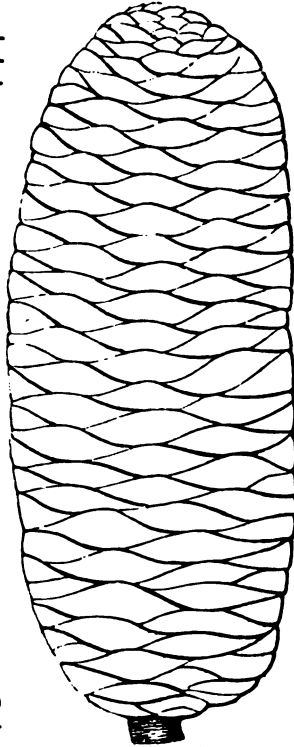

larly dentate, very short. (*Don* in *Lamb. Pin.*) Leaves from $\frac{1}{2}$ in. to 1 in. long. Cones, according to Lambert, $6\frac{1}{2}$ in. long and $3\frac{1}{2}$ in. broad; but in Douglas's specimens the largest cones are only $3\frac{1}{2}$ in. long, and 2 in. broad, the others being much smaller. Scale $\frac{1}{2}$ in. long, and $\frac{1}{2}$ in. broad. Seed small; with the wing, $\frac{1}{2}$ in. long, and $\frac{3}{4}$ in. broad. A native of the north-west of America; discovered by Douglas, and introduced by him in 1831.

Description. A noble tree, akin to *P. balsamea*, growing from 170 ft. to 200 ft. high, with a brown bark. Leaves pectinate and spreading, linear, roundish at the apex, emarginate, callous on the margin, quite entire; green and shining above, silvery beneath, somewhat dilated towards the apex; 1 in. long. Cones lateral solitary, cylindrical, obtuse, very similar to *P. Cèdrus*, but larger, 6 in. long, of a chestnut-brown colour; scales transverse, very broad, lamelliform, deciduous, stalked, incurved on the margin, quite entire. Bracteoles ovate-acuminate, irregularly crenulate on the margin, much shorter than the scales, included. Seeds oblong, with a coriaceous testa; wing very broad, axe-shaped, truncate at the apex, slightly scarious and membranaceous, brittle, shining, pale. (*Lamb.* and *Dougl.* in *Comp.*

Bot. Mag., ii. p. 147.) A native of northern California, in low moist valleys where it attains the height of 200 ft. The wood is soft, white, and of inferior quality, like *P. religiosa*, to which, according to Professor Don, it is nearly related. It resembles the cedar of Lebanon in the form and structure of its cones, which are three times the length of the leaves; with ovate-acuminate bracteas, much shorter than the scales. (*D. Don.*) The plant in the Horticultural Society's Garden was, in 1837, 1 ft. high.

‡ 6. *P. AMA'BILIS* Dougl. The lovely Silver Fir.

Synonymy. *Pinus amabilis* Douglas MS.

Engravings. Our figs. 2247, 2248., from Douglas's specimens in the herbarium of the Hort. Soc.

Spec. Char., &c. Leaves flat, obtuse, entire. Cones cylindrical; bracteoles very short, pointed. Scale triangular; the upper margin rounded, entire. Leaves, on Douglas's specimen, $1\frac{1}{4}$ in. long, and on the young plant in the Horticultural Society's Garden, $\frac{7}{8}$ in. long. Cones 6 in. long, and $2\frac{1}{2}$ in. broad. Scales, $1\frac{1}{4}$ in. broad, and about $1\frac{1}{2}$ in. long. Seed,

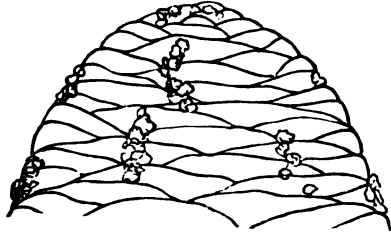

with the wing, 1 in. long; wing $\frac{3}{4}$ in. broad. The cone in Douglas's specimen is about twice as large as those sent home by him of *P. grandis*, and the leaves are entire instead of being emarginate; but, in other respects, we have been quite unable to discover any difference, either between the dried specimens, or the young plants, worthy of being considered specific. The cones were sent home by Douglas in 1831, without any further information than the name. As there are young plants in the Chiswick Garden, all that is here said must be considered as provisional, till these plants have shown some characteristic features by which they may be either distinguished from, or associated with, other species.

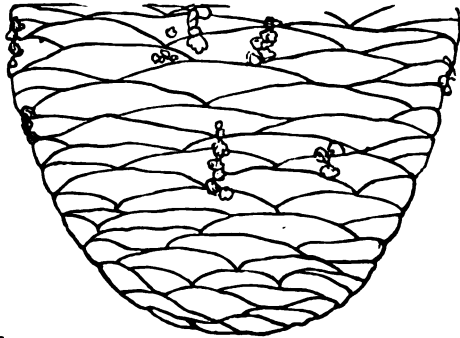

‡ 7. *P. NO'BILIS* Dougl. The noble, or large-bracted, Silver Fir.

Synonymy. *Pinus nobilis* Dougl. MS., *Lamb. Pin.*, 2., last fig.; *A. nobilis* Lindl. in *Penny Cyc.*, No. 5. *Engravings.* *Lamb. Pin.* icon; and our figs. 2249. and 2250., from Douglas's specimens in the herbarium of the Horticultural Society.

Spec. Char., &c. Leaves mostly on one side of the branches, falcate, short, acute, silvery beneath. Cones cylindrical; bracteoles elongated, spatulate,

gnawed, imbricated backwards (*Don in Lamb. Pin.*) Leaves $1\frac{1}{2}$ in. long. Cone $6\frac{1}{2}$ in. long, sessile; $2\frac{1}{2}$ in. broad. Scale triangular; without the bractea, $1\frac{1}{2}$ in. long, and the same in breadth; bractea $\frac{1}{2}$ in. long. Seed small, irregular; with the wing, $1\frac{1}{2}$ in. in length. Wing $\frac{1}{2}$ in. broad in the widest part. Cotyledons, ? Natives of the north-west of North America, where it was discovered by Douglas, and introduced in 1831.

Description, &c.

A large tree, with cinnamon coloured bark. Leaves crowded, 2-rowed, linear, falcate, for the most part acute, compressed trigonal; flat above, marked with a depressed line; silvery beneath; scarcely 1 in. long. Cones solitary, lateral, cylindrical, thick; brownish; 6—7 in. long, and 8—9 in. in circumference: scales lamelliform, stipulate, copiously covered with minute down; incurved and quite entire on the margin. Bracteoles much exerted, spatulate, adpressed backwards, imbricated; laminae dilated, membranaceous; points elongated, awl-shaped, rigid. Seeds oblong, with a coriaceous testa: wing broad, axe-shaped, thinly membranaceous, pale-coloured; nearly allied to *P. Fraseri*, but with cones five times as large. (*Lamb.*) According to Douglas (*Comp. Bot. Mag.*, ii. p. 147.), this is a majestic tree, forming vast forests upon the mountains of Northern California, and producing timber of excellent quality. "I spent three weeks in a forest composed of this tree," he says, "and, day by day, could not cease to admire it." The plant in the Horticultural Society's Garden

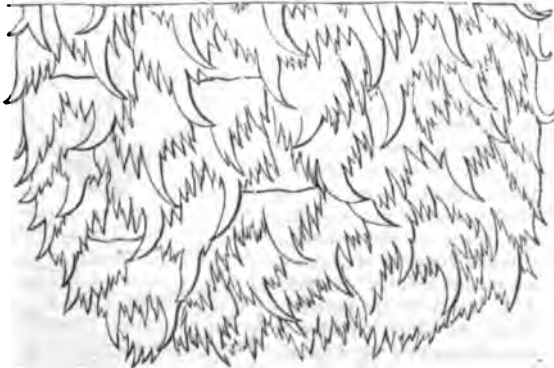
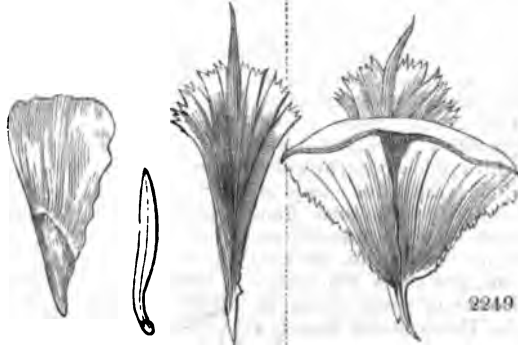

was, in 1837, 1 ft. high. The finest plants of this species in the neighbourhood of London are at the Hendon Rectory, where, in October, 1837, one was 2 ft. high, and the other 1 ft. 8 in., both in pots. Price of plants, in the London nurseries, three guineas each.

28. *P. WEBBIANA* Wall. Webb's purple-coned Silver Fir.

Synonymes. *Pinus Webbiana* Wall. in Litt., Lamb. Pin., ed. 2., 2. t. 44.; *P. spectabilis* Lamb. Monog., 2.; p. 3. t. 2.; *Abies Webbiana* Lindl. in Penn. Cyc., No. 7., Royle Illust.; Chisrow, and the Conum, or purple-coned fir, in the Himalayas.

Engravings. Lamb. Pin., ed. 2., t. 44.; Monog., 2. t. 2.; and our *Agg.* 2251. and 2252.

Spec. Char., &c. Leaves 2-rowed, linear, flat, obtusely emarginate, silvery beneath. Cones cylindrical; scales kidney-shaped, roundish; bracteoles oblong, apiculate. (*D. Don.*) Buds round, pointless, thickly covered with a yellow resin, by which alone the tree may be readily distinguished from every other species of *Picea*. Cones from 6½ in. to 7 in. long, and above 2 in. broad. Leaves of young plants, in the Horticultural Society's Garden, from 1½ in. to 2½ in. long. Scale above 1 in. long, and 1½ in. broad. Seeds, with the wing, ¾ in. long; wing ⅔ in. broad in the widest part. Seeds ⅝ in. long, and ⅓ in. broad. In general they are smaller, but longer, and with a sharper point, than those of the common silver fir; and, like the seeds of the common silver fir, they are of a brownish purple colour. Cotyledons, ?. A tree, a native of Nepal, in which country it was discovered by Captain W. S. Webb. Introduced into England by Dr. Wallich, in 1822.

Description, &c. A large, handsome, pyramidal tree, from 80 ft. to 90 ft. high, with a trunk from 3 ft. to 4 ft. in diameter near the base. Branches numerous, spreading horizontally, much divided, densely clothed with leaves, disposed in whorls, covered with a pale ash-coloured, rough, scaly bark; bent upwards at the apex. Wood compact, whitish rose-colour. Leaves linear, solitary, crowded, 2-rowed, spreading, coriaceous, smooth, shining; 1½ in. to 2 in. long, 2 lines broad; very dark green above; canaliculate, somewhat deflexed on the margin, quite entire;

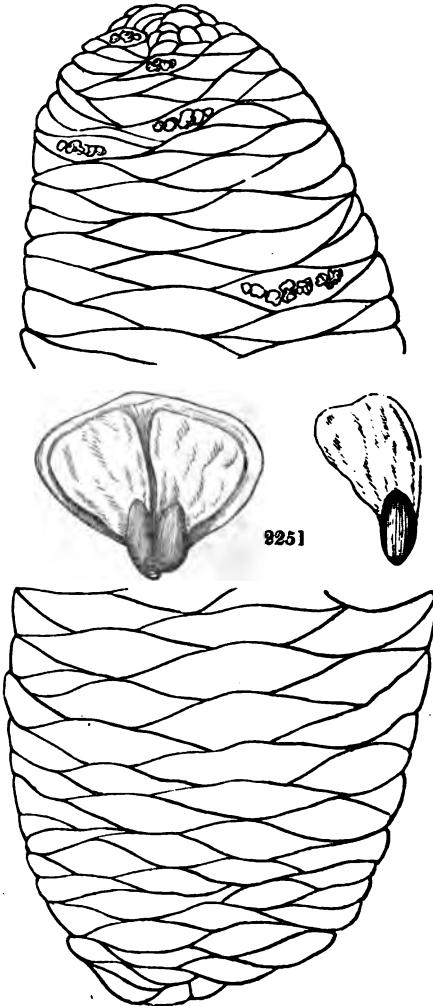

white beneath, emarginate at the apex. Catkins lateral, sessile; having at the base many, short, closely imbricated scales, round and membranaceous in the male, and broad ovate in the female. Male catkins numerous, cylindrical, slender, simple, springing from the lower side of the extremities of the branches: stamens monadelphous: anthers short, obconate, on short stalks, imbricated backwards, having at the apex a convex somewhat kidney-shaped crest; conical and 2-horned above; horns very short, obtuse, divaricate. Female catkins solitary, oblong, cylindrical, erect; 1 in. long, dark purple:



scales short, roundish, wedge-shaped, membranaceous on the margin, repando-denticulate, recurved at the apex, mucronate. Cones solitary, erect, obtuse, cylindrical; 4 in. to 6 in. long, and $1\frac{1}{2}$ in. to 2 in. in diameter, proceeding from the upper side of the extremities of the branches; of an intense purple; full of resin, which exudes in numerous transparent pendulous globules, yielding by expression a purple pigment. Scales short, broad-wedge-shaped, much dilated at the apex; leathery, roundish, quite entire, inflexed, densely imbricated, with a very short, mutic, persistent scale (bractea) at the base. Seeds oval-oblong, angular, obovulate in a thick hard coriaceous testa; taste acrid, and odour very resinous: wing slender, membranaceous, broad, quite entire, obovate-axe-shaped. (*Lamb.*) It is a native of the alps of Gossainthan in Nepal, and of the Himalayas, where it was discovered by Captain W. S. Webb, "a distinguished traveller, and a zealous investigator of natural history, deservedly known for his admirable survey of the Himalayan alps." Captain Webb gave the following account of the tree to Dr. Wallich: — "This purple-coned pine attains a height of 80 ft. or 90 ft., with a diameter of the stem near the ground of from 3 ft. to 4 ft. The cone is produced on the extremity of the shoots. The leaves are about 1 in. long, of a beautiful light green, having a white stripe in the centre. The wood even equals, in the texture of its grain and in odour, the Bermudas cedar. The fruit is said to yield, at full growth, a purple pigment by expression. The silvery hue of the bark, the beautiful contrast of the leaves with the rich purple of the cone, glittering with globules of transparent resin, produce in combination one of the most striking objects which can well be imagined, and entitle the tree to precedence for ornamental purposes." Seeds were repeatedly sent to England, by Dr. Wallich, to Mr. Lambert and others; but none appear to have vegetated till about 1822; when some plants were raised in the Fulham Nursery. The largest of these, which is now at Dropmore, and of which our *fig.* 2253. is a portrait, to scale of 1 in. to 8 ft., was, in 1837, after being 10 years planted, 8 ft. high; and had a cone which on the 14th of July was $3\frac{1}{4}$ in. long, and on the 1st of October, was about 5 in. long. As the tree has produced no male catkins, no perfect seeds can be expected from this cone; but its intensely dark, and yet brilliant purple hue, amply justifies the description of Captain Webb. The plant, in the climate of England, appears rather more tender than the silver fir; being liable, from its vegetating very early in spring, to have its leading shoots pinched by the frost. After a series of years, however, and propagation from seeds ripened in this country, it will, in all probability, accommodate itself in a considerable degree to the peculiarities of our climate. When once the tree begins to bear cones, they may be fecundated with the male blossoms of the common silver fir, and thus a hybrid produced somewhat harder than the female parent. As a timber tree, it is never likely to be of much value in this country; though, in India, its wood is said to equal in the texture of its grain, and in its odour, the Bermudas cedar;



2253

but, as an ornamental object, all who have seen the tree, either at Dropmore or in the Horticultural Society's Garden, must allow that it is one of the finest of the silver firs. There are very handsome plants in the Horticultural Society's Garden, which, after being 6 years planted, were, in 1837, nearly 6 ft. high. At the Hendon Rectory, there are several plants in pots, from 3 ft. to 4 ft. high. Price of plants, in the London nurseries, 2 guineas each. These plants are generally raised from cuttings; but, notwithstanding this, they make apparently as good and as erect-growing plants as those raised from seeds.

† 9. *P. PINDROW* Royle. The Pindrow, or tooth-leaved, Silver Fir.

Synonymes. *Pinus Pindrow* Royle III, t. 86; *Lamb. Pin.*, 3. t. 92; *Taxus Lambertiana* Wall. Cat.; Pindrow, and sometimes *Morinda*, in the Himalayas.

Engravings. Royle III, t. 86; *Lamb. Pin.*, 3. t. 92; our *figs.* 2254 and 2255, from Royle.

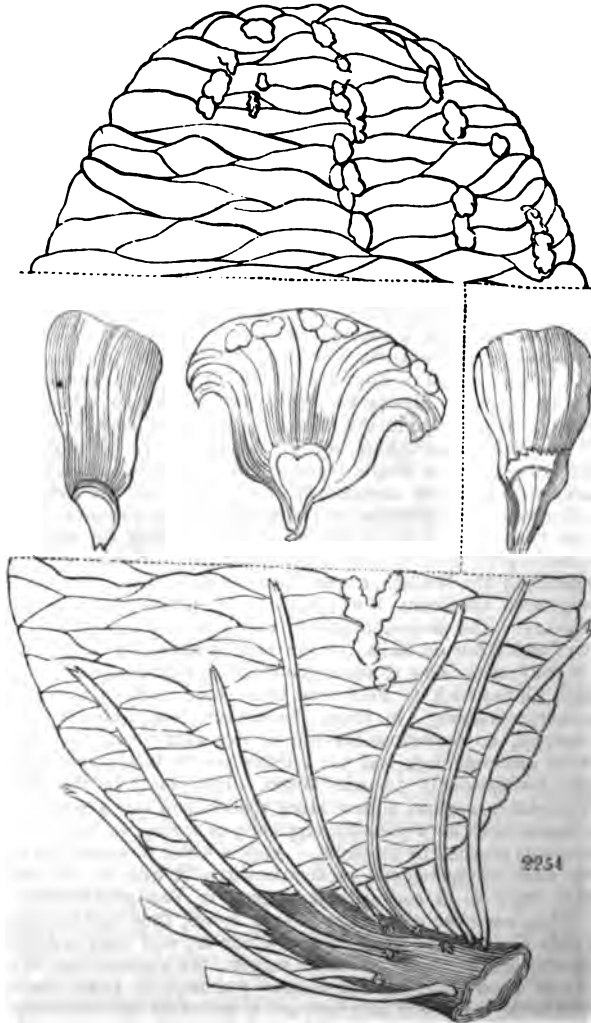

Spec. Char., &c. Leaves 2-rowed, linear, flat, of the same colour on both sides; sharply 2-toothed at the apex. Crest of the anthers 2-horned. Cones oval; scales trapezoideo-cordate; bracteoles roundish, emarginate, irregularly crenulate. (*Don in Lamb. Pin.*) Leaves 3 in. long. Cone 4½ in. long, 3½ in. broad, of an intense purple. A tree of Kamaon, discovered by Captain Webb and Drs. Govan and Royle, and introduced by Dr. Royle in 1837.

Description, &c. A large tree. Trunk straight, covered with an ash-grey bark, 80 ft. to 100 ft. high. Branches verticillate, spreading, leafy. Leaves 2-rowed, spreading, scattered in insertion, twisted at the base, linear, flat, acutely bidentate at the apex (teeth callous, connivent, and often unequal); obtuse and quite entire on the margin; of the same colour on both sides; shining, marked above with a somewhat depressed line, rather silvery beneath; when young, having an elevated roundish midrib, 2 in. and more in length, and about 1 line broad. Male catkins lateral, scattered, cylindrical, 1 in. long, imbricated with many very short, obtuse, concave, dark yellow scales; scarious on the margin. Stamens crowded, imbricated. Filaments very short, distinct. Anthers linear wedge-shaped, dark yellow, 2-celled; crest very short, coriaceous, rigid, 2-lobed (lobes divergent, horned); cells inserted beneath, swelled, membranaceous, opening by an oblong fissure; one of the cells sometimes abortive, and hence the anther 1-celled. Cones lateral, solitary, erect, oval, very obtuse, 5 in. long, greyish brown: scales trapezoid-heart-shaped, somewhat square, coriaceous, rigid, striated; superior margin roundish, incurved, quite entire; angles dilated, recurved, roundish, membranaceous, ragged: stalk angled, very short, keeled on both sides, prolonged above the base: bractees very short, roundish, emarginate, irregularly crenulated on the margin. Seeds small, angled, brown, shining; exterior testa (primine) disjoined on the inner side, from the growth of the ovule, lengthened into the large, quite entire, axe-shaped, pale brown wing; interior (secundine) closely investing the nucleus, terminated by a very short, paler, irregularly crenulated wing. (*D. Don.*) *P. Webbiana* differs in having leaves only half as long, obtusely emarginate, silvery beneath; cones cylindrical, longer; scales kidney-shaped, roundish; bracteoles oblong, apiculate; and finally in the seeds and wing being of a pale bright brown. (*Id.*) Professor Don observes that *P. Pindrow* is liable to be confounded with *P. Webbiana*; but that the former is readily distinguished from the latter by its longer and acutely bidentate leaves, of nearly the same colour on both surfaces; and by its shorter and thicker cones, with trapezoid-formed scales, and rounded notched bracteoles. Dr. Royle, who appears to have been the only botanist who found the tree either in flower or in fruit, states that it grows to a large size, varying from 80 ft. to upwards of 100 ft. in height, with widely spreading branches; and that he met with it at an elevation of 1000 ft. above the level of the sea. From cones presented by Dr. Royle to the Horticultural Society, one or two plants were raised, in 1837, by the care and attention of Mr. Gordon. It is difficult to decide in the case of any species of *Abietinæ* from very young seedling plants; nevertheless, from those in the Horticultural Society's Garden, and especially from the incipient bifurcations of the leaves at the apex, we feel disposed to consider *P. Pindrow* as only a variety of *P. Webbiana*.



‡ 10. *P. BRACKETTA* D. Don. The leafy-bracted Silver Fir.

Synonymes. *Pinus bracteata* Lin. *Trans.*, 17, p. 443, *Lamb. Pin.*, 3; *P. venusta* Dougl. in *Comp. to Bot. Mag.*, 2, p. 152.

Engravings. *Lamb. Pin.*, 3, t. 91.; and our fig. 2256, from Lambert.

Spec. Char., &c. Leaves 2-rowed, linear, mucronate, flat, silvery beneath. Cones ovate. Bractees 3-lobed; the middle division very long, leaf-like, recurved. (D. Don.) Cones 4 in. long. Bractees nearly 2 in. long. Leaves 2 in. long. A large tree, a native of California, discovered by Douglas in 1832, and about the same period by Dr. Coulter, but not yet introduced.

Description, &c. An elongated pyramidal tree. Trunk very straight and slender, 120 ft. high; scarcely 1 ft. in diameter at base; only the upper third covered with branches. Bark chestnut-brown. Branches verticillate, spreading; lower ones slightly decumbent. Leaves crowded, scattered in insertion; but 2-rowed, linear, mucronate, flat, coriaceous, rigid; 2 in. to 3 in. long, 1 line broad; light green, and shining above, marked with a depressed line; silvery beneath, slightly revolute on the margin; midrib and apex callous. Cones on adult branches only, solitary, lateral, almost sessile, erect, ovate turgid; 4 in. long, and 2 in. in diameter; with numerous, ovate-oblong, acute, scarious, torn, bright brown, revolute, persistent scales, at the base; scales kidney-shaped, roundish, concave, stalked, thick, indurated; pale brown, incurved on the margin, crenulate, glaucous externally; stalk sharply keeled above, shorter than the disk. Bractees wedge-shaped, adpressed, coriaceous, rigid; of the

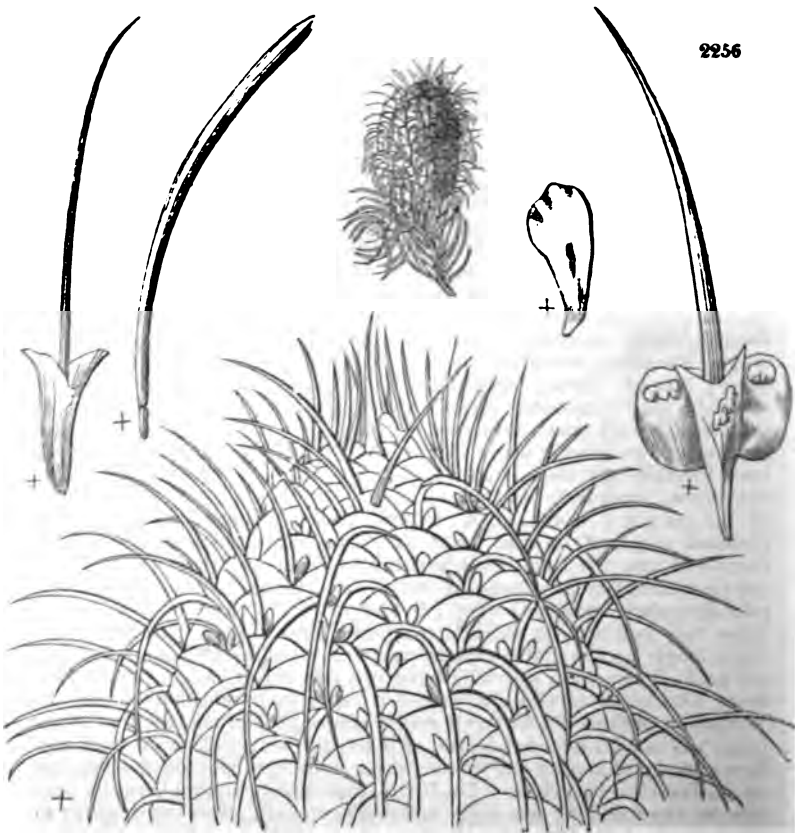

same colour as the scales, but shorter; adnate and callous below, 3-lobed at the apex: lobes lateral, very short, roundish, irregularly dentate; middle one recurved, 1½ in. long, resembling true leaves in every respect, but only half the breadth. Seeds wedge-shaped, oblong, tetragonal; exterior testa (pericarp) greyish brown, disjoint, and open at the interior angle, where the nucleus is exposed, with the apex extended into the unequally sided, obovate, quite entire, thinly membranaceous, flat, reticulated wing. Nucleus included in a crustaceous, dark brown, proper testa (sarcotesta), crowned at the apex by a very short, membranaceous ragged wing. (Don in *Lin. Trans.*) This curious and interesting species of fir was discovered by Douglas, in March, 1833, on the high mountains of Colombia. Dr. Coulter found it on the sea side range of Santa Lucia, about 1000 ft. lower down than *P. Coulteri*. The trunk rises to the height of 120 ft.; is very slender, not exceeding 2 ft. in circumference; and as straight as an arrow. The upper third of the tree is clothed with branches, giving it the appearance of an elongated pyramid. The branches are spreading; the lower

ones are decumbent. The bracteas are low and recurved, and but little changed from the ordinary leaves, which gives the cones a singular appearance." (*Lamb. Pin.*, vol. iii.) "When on the tree, being in great clusters, and at a great height withal, the cones resemble the inflorescence of a *Banksia*, a name I should like to give this species, but that there is a *P. Banksii* already. This tree attains a great size and height, and is on the whole a most beautiful object. It is never seen at a lower elevation than 6000 ft. above the level of the sea, in lat. 36°, where it is not uncommon." (*Dougl. in Comp. to Bot. Mag.*, 2 p. 152.) From the singular appearance of the cones, and general beauty of the tree, this seems to be a most desirable species for introduction.

211. *P. RELIGIOSA* Humb. et Kunth. The sacred Mexican Silver Fir.

Synonymes. *Pinus religiosa* Humb. et Kunth *Nov. Gen. et Sp. Pl.*, 2 p. 5., *Schiede et Deppe in Schlecht. Linnæa*, 5 p. 77., *Lamb. Pin.*, 1. t. 43.; *Abies religiosa* Lindl. in *Penny Cyc.*

Engravings. *Lamb. Pin.*, 1. t. 43., and vol. 3. t. 95.; and our *fig. 2257*.

Spec. Char., &c. Leaves linear, acute, quite entire, somewhat pectinate. Cones roundish-oval; scales trapezoido-cordate, lamelliform; bracteoles the length of the scales, spatulate-oblong, sharply dentato-serrate; wings of the seed plicate. (*Don in Lamb. Pin.*, iii.) Leaves $1\frac{1}{2}$ in. long. Cones $2\frac{3}{4}$ in. long, and $2\frac{1}{2}$ in. broad. Seed small and irregular. Cotyledons, 2.

Description, &c. A tall tree. Branches covered with a brown bark. Leaves scattered in insertion, but 2-rowed, somewhat pectinate, linear, acute; obtuse on the margin, quite entire, coriaceous, glabrous; 1 in. long, marked above with a depressed line, silvery beneath, especially when young; afterwards both sides of the same colour. Cones like that of the cedar, roundish-oval, $1\frac{1}{2}$ in. long, very obtuse, brown; scales very broad, lamelliform, deciduous, somewhat trapezoidal; heart-shaped at the base; acute, quite entire and incurved on the margin; angles lengthened, coriaceous, rigid; stalk very short, wedge-shaped, keeled on both sides, the under angle more elevated. Bracteoles about the length of the scales, spatulate-oblong, obtuse, membranaceous, sharply and irregularly

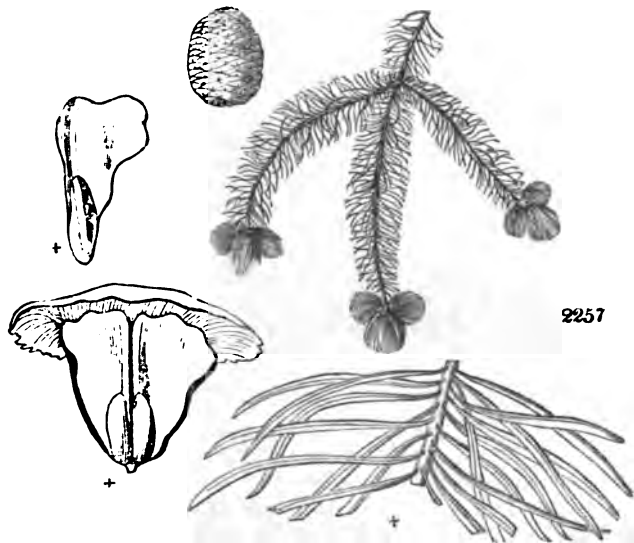

dentato-serrate. Seeds of a pale bright brown, wedge-shaped, a little compressed; exterior testa widely disjointed on the inner side; wing axe-shaped, thinly membranaceous, somewhat transparent, folded lengthwise. Nucleus entirely covered with the interior testa, obliquely crowned with a very short wing. (*Lamb.*) This is a tall and elegant tree, found by Humboldt on the lower hills of Mexico, between Masantla and Chilpancingo, at an elevation of 4000 ft. Deppe and Schiede found it upon the cold mountains of Orizaba, at the highest limit of arborescent vegetation. The leaves are larger, and the branches more slender than those of any other of the silver fir tribe; and they are used by the Mexicans for adorning their churches. The flowers have not yet been described by European botanists. It is easily recognised from every other species of silver fir by the shortness of its cones, which, in form and structure, bear a marked resemblance to those of the cedar of Lebanon, although they are considerably smaller. From the elevated situation on which it grows, there can be little doubt of its proving perfectly hardy in Britain; and the botanists now exploring Mexico will, no doubt, soon send home seeds of it.

? *P. hirtella*; *Abies hirtella* Lindl. in *Penny Cyc.*, No. 11.; *Pinus hirtella* Humb. et Kunth, l. c.; has the young branches covered with hairs. Leaves arranged in 2 rows, flat, acute, glaucous beneath; about $1\frac{1}{2}$ in. long. Flowers and cones unknown. Found on the mountains of Mexico at an elevation of 8000 ft. or 9000 ft. A low tree, from 18 ft. to 20 ft. high; not yet introduced.

GENUS IV.

LA'RIX Tourn. THE LARCH. *Lin. Syst. Monoc'cia Monadelphica.*

Identification. Tourn. Inst., 586; Bauh. Pin., 493; Bellon. Arb. Conf., p. 23. 25.; Tab. Icon., 940.

Synonymes. Pinus of Lin. and others; *Abies Rich.*; *Melèze, Fr.*; *Lerchenbaum, Ger.*; *Laricio, Ital.*

Derivation. From *lar*, fat, Celtic; the tree producing abundance of resin.

Description. Deciduous trees, some of them of large dimensions; natives of the mountainous regions of Europe, the west of Asia, and of North America; highly valued for the great durability of their timber. The common larch is found extensively on the alpine districts of the south of Germany, Switzerland, Sardinia, and Italy; but not on the Pyrenees, nor in Spain. The Russian larch (*L. e. sibirica*) is found throughout the greater part of Russia and Siberia, where it forms a tree generally inferior in size to *L. europæa*. The black, or weeping, larch (*L. americana pendula*) is a slender tree, found in the central districts of the United States; and the red larch (*L. americana rubra*), also a slender tree, is found in Lower Canada and Labrador. In Britain, all the species are ornamental; but the first is the only one at all deserving of culture as a timber tree. Much more experience having been gained in Scotland respecting the larch than in England, and more by Mr. Gorrie than by any man in Scotland that we know, we have submitted the whole of our article upon the larch to him, and he has kindly sent us some notes and comments, which will be found in their proper places.

‡ 1. *L. EUROPEA Dec.* The European, or common, Larch.

Identification. De Cand. Fl. Fr., No. 2064.

Synonymes. Pinus Larix *Lin. Sp. Pl.*, 1420, *Syst.*, ed. Reich., 4. p. 175, *Willd. Sp. Pl.*, 4. p. 203, *Hist. Evol. Syst.*, p. 267., *Trew in Nov. Act. A. N. C.*, App., 3. t. 13., *Pall. Ross.*, 1. p. 1., *Pall. Ann.*, 1. p. 451. and 2. p. 127., *Alton Fl. Ped.*, 2. p. 178., *Vill. Dougl.*, 3. p. 807.; *Art. Hort. Kew.*, ed. 1., 3. p. 369., *Willd. Berl. Baumz.*, p. 310., *Lamb. Pin.*, ed. 2., t. 48., *Hall. Herb.*, No. 1138., *Du Roi Harbk.*, ed. Pott., 2. p. 85., *Reiter und Abel. Abbild.*, t. 96., *Willd. Baumz.*, p. 274., *Hayne Dend.*, p. 175., *Hayne Abbild.*, p. 271., *Essai Anstet.*, p. 15.; *Abies Lin. Hort. Cap.*, 450., *Genet. Sib.*, 1. p. 176.; *Larix decidua Mill. Dict.*, No. 1.; *Larix folio deciduo, Gen. Bot. Hist.*, 1. p. 285., *Hort. Seng.*, p. 43., *Du Ham. Arb.*, 1. p. 332., *Tourn. Inst.*, p. 586.; *Larix Europ. Pin.*, p. 463., *Dod. Seng.*, p. 868., *Com. Epit.*, 45., 46.; *Abies Larix Lam. Diss.*, t. 785. t. 2., *Petr. Dict.*, 6. p. 571., *N. Du Ham.*, 5. p. 287. t. 7951., *Rich. Mém. sur les Conf.*, p. 65., *Lindl. in Penn. Cyc.*, 1. p. 32.; *Melèze commune, Fr.*; *Lärche, Lorcher-Fichte, gemeiner Lerchenbaum, Terbentbaum, Europäische Ceder, weisser Lerchenbaum, Ger.*

Engravings. *Nov. Act. A. N. C.*, App., 3. t. 13. f. 8. 28.; *Pall. Ross.*, 1. t. 1.; *Ludw.*, &c., t. 86.; *Blackw.*, t. 477.; *Wood. Med. Bot.*, t. 210.; *Reitt. and Abel. Abbild.*, t. 96.; *Du Ham. Arb.*, 1. t. 1.; *Hayne Abbild.*, t. 154.; *N. Du Ham.*, 5. t. 79., f. 1.; *Lamb. Pin.*, ed. 2., 2. t. 48.; our *Ag.* 2258.; and the plates of this tree in our last Volume.

Spec. Char., &c. Leaves fasciated, deciduous. Cones ovate-oblong; scales reflexed at the margin, lacerate; bracteoles panduriform. (*Willd.*) Leaves linear, soft, 1 in. long. Cone from 1 in. to 1½ in. long, erect. A tall pyramidal tree, a native of the alps of the south of Europe; in cultivation in Britain since 1629; flowering in March or April.

Varieties. All the larches in cultivation are, probably, only different forms of the same species; but, as the American larches, which have small fruit, come tolerably true from seed, we shall treat them as one species, and the European larch as another. The latter is characterised by large cones, rapid growth, and robust habit; and the former by small cones, slow growth, and slender habit.

‡ *L. e. 1 communis Laws. Man.*, p. 386., *the common European Larch*, has branches "aspiring towards their points; branchlets very numerous, and forming a dense conical or pyramidal top; foliage of a light grassy or vivid green, and bark rather more rugged than that of *L. e. 2 laxa*."

- † *L. e. 2* *læra* Laws., l. c. *The loose-headed European Larch*.—" True specimens of this variety may easily be distinguished from the others when in nursery rows, by their more rapid growth, more horizontal and less crowded branches, and by the darker green, or somewhat glaucous, colour of the foliage. When the trees advance to a more mature age, they, besides their greater size and the preceding peculiarities of the foliage, are easily distinguished by their larger, thinner, more graceful and somewhat pendent branches; cones also larger, more tapering, pointed, and less compact, than those of the common sort. These remarks are merely from observation of the trees in a young state; but it would be a matter of some importance to ascertain the difference, if any, in the value of their timber." (*Laws. Man.*, p. 386.)
- † *L. e. 3* *compacta* Laws., l. c. *The compact, or crowded-branched, Larch*.— This name is applied, in Lawson's *Manual*, to a very distinct kind of larch, without any regard as to whether it should be allowed to rank only as a variety of *Larix europæa*, or form a different species. Specimens of the cones and branches of *L. e. 3* *compacta* were received from Mr. A. Gorrie, Annat Gardens, who had the seeds sent him, about 20 years since, from Yorkshire, as those of the American black larch (*L. americana pendula*); to which, however, it does not bear the least resemblance. " The trees at Annat Garden are growing on very superior, rather heavy, deep, blackish soil; and the largest had not, in 1835, attained more than 16 ft. in height, not being much more than half the size which the common larch would have attained under similar circumstances. In habit of growth, the tree is conical or pyramidal, like the common larch; but its branches are very brittle, or easily broken from the trunk; numerous, horizontal, or slightly bent down near their base; aspiring afterwards, and the larger ones are finally erect towards the point, with pretty regularly verticillate branchlets; towards the centre of the tree, however, these are pendulous, and remarkably thickly interwoven with one another. The bark is very rugged or scaly, and thick; cones often small, irregularly shaped, with very much waved and incurved, or folded, scales; but, when fairly grown, nearly as large as those of the common larch; than which, however, their scales are smoother, blunter-pointed, considerably more incurved at the margins, and equally persistent. Bractæas much shorter than the scales. The seeds are seldom perfected in this country; and the foliage is of a light grassy-green colour. Regarding the quality of the wood of this variety or species little is known; but, from its slow growth, it does not appear likely ever to become of importance as a forest tree." (*Lawson's Manual*, p. 387.)
- † *L. e. 4* *pendula* Laws., l. c. *The weeping European Larch*; the weeping Larch from the Tyrol, *Hort. Trans.*, vol. iv. p. 416.— This, Mr. Lawson observes, is rather a scarce variety, and very distinct. There are large trees of it in the Duke of Athol's plantations at Dunkeld, raised from seeds received from the Tyrol. The tree is distinguished by the very pendulous habit of its branches, which somewhat resemble those of *L. americana pendula*; from which, however, it differs in the greater length of its leaves, and the larger size of its cones.
- † *L. e. 5* *repens* Laws. l. c.— A tree with this name in the Horticultural Society's Garden, received from Lord De Roos, has a tendency to extend its lower branches along the ground, rather more than the common larch. It is of luxuriant growth, and, from its leaves and cones, evidently belongs to *L. europæa*. It was, in 1837, after being 12 years planted, 16 ft. high; and the branches covered a space upwards of 20 ft. in diameter.

- 2 L. e. 6 *flora rubra*. The common Larch, with red or pink flowers, Hort. Trans., iv. p. 416. — This variety is the most common in extensive plantations of larches. The flowers vary in shade of red or pink, and some of them are more or less mixed with yellow. The cones are also red, or reddish yellow. The majority of the trees in the Duke of Athol's plantations at Dunkeld and Blair have red flowers.
- 3 L. e. 7 *flora alba*. Larch from the Tyrol, with white flowers, Hort. Trans., l. c. — The leaves of this variety are not different from those of the common larch; but the shoots are said to be much stronger; and the cones white, as well as the flowers.
- 4 L. e. 8 *sibirica*; *L. sibirica* Fisch.;? *L. archangelica* Less. Man., p. 389; *L. rossica* Sab. in Hort. Soc. Gard.; *Pinus L. sibirica* Lodd. Cat. The Russian Larch, Hort. Trans., iv. p. 416. — There are trees of this variety in the Duke of Athol's plantations, raised from seeds procured from Archangel in 1806. The appearance of the tree is said to be coarser than that of *L. e. communis*: it is of much slower growth than the larches of the Tyrol; and the leaves turn out so early in spring, that they are liable to be injured by frost. The female catkins do not expand their flowers till some time after those of the European larch appear. The cones are like those of the American larch. The bark is quite cinereous, and not distinctly scarred, as in the common larch. This variety, Professor Pallas informs us, is found in cold mountainous places, from the Ural Mountains northwards, through Siberia and Kamtschatka, to the Pacific Ocean. It delights in a middle station on the sides of mountains, where it is sheltered from the north, and exposed to the east wind, growing in a gravelly or rocky soil. In valleys and marshes, or on the very tops of mountains, it never occurs. It extends as far north as lat. 66°, where it forms a trailing shrub; but, in the south of Siberia and Russia, it grows to the same height and bulk as the European larch. In the north, it has more the habit of the American larch; but it differs, he adds, from that species very essentially. (*Fl. Ross.*, part i. p. 2.) The Siberian hunters of crumens, Gmelin observes, when their yeast or leaven, which they carry with them to make the acid liquor which they call quass, is spoiled by the cold, scrape off the soft wood, under the bark of the larch, which is very juicy and sweet; digest it with water over the fire during an hour, make it into dough with their rye meal, which they bury in the snow; and, after twelve hours, they find it in a state of fermentation, and ready for use. Baudrillart states that an officer employed in the management of the Russian woods informed him that ships of war, of even 120 guns, were built of larch at Archangel; and, of course, other smaller vessels. In consequence of a similar report, the late Duke of Athol procured seeds from Archangel, which he sowed among his plantations of the common larch. The young plants grew vigorously at first; but, in the course of a few years, they were found very far inferior to the common larch, and, when cut down, to be of very little value. The Siberian larch was introduced into England by Messrs. Loddiges, to whom the seed was sent by Professor Pallas, about the end of the last century. The plant in the Horticultural Society's Garden, after being five years planted, is 4 ft. high, with a peculiarly stunted appearance.
- 5 L. e. 9 *dahurica*; *L. dahurica* Less. Man., p. 389; *Pinus dahurica* Larch; is said to be a stunted, bushy, and irregular growing tree. It is a native of Dahuria, and was first introduced into Britain in 1827. It is generally propagated by cuttings or layers, which will account for its stunted appearance.
- 6 L. 10 *intermedia*; *L. intermedia* Less. Man., p. 389; *Pinus intermedia* Lodd.

Carved: 1836. *The intermediate, or Albanian, Larch.* — According to Lawson, this variety "seems naturally possessed of a very strong luxuriant habit of growth, with pendulous branches, and very large leaves; but, like many more Siberian or northern Continental plants, it produces its leaves on the first approach of spring, and is therefore very liable to be injured by the cold changeable weather to which this country, in the earlier part of the season, is so liable." (*Lans. Man.*, p. 389.) We have only seen the plant at Messrs. Loddiges's, which is 5 ft. high, with longer leaves than the species, but stunted and unthriving in its general appearance. It was introduced in 1816, or before.

Other Varieties. L. *Fraseri* is included in *Comp. Bot. Mag.*, vol. ii. p. 304, in a list of North American plants discovered and introduced by J. Fraser and his son between 1785 and 1817; but we know nothing farther of the plant.

Description. A tree, rising, in favourable situations on the Alps, and also in Britain, from 80 ft. to 100 ft. in height, with a trunk from 3 ft. to 4 ft. in diameter, and having a conical head. It is well described in Lawson's *Manual*, as having the "branches subverticillate, and spreading horizontally from the straight trunk; occasionally, however, rather pendulous, particularly when old. Branchlets also more or less pendulous. Leaves linear, soft, blunt, or rounded at the points, of an agreeable light green colour; single or fasciculated; in the latter case, many together round a central bud; spreading and slightly recurved. Male catkins without footstalks, globose or slightly oblong; of a light yellow colour; and, together with the female catkins, or young cones, appearing in April and the beginning of May; the latter varying from a whitish to a bright red colour. Cones of an oblong-ovate shape, erect, full divid. in length, and of a brownish colour when ripe; scales persistent, roundish, bristled, and generally slightly waved, but not distinctly notched on the margin; bractæe generally longer than the scales, particularly towards the base of the cones. Seed of an irregular or ovate form, fully $\frac{1}{4}$ in. long, and more than half surrounded by the smooth, shining, persistent pericarp. Cotyledons 5 to 7." (*Lans. Man.*, p. 383.) The cones are ripened abundantly in most parts of Britain, and the tree in many situations in Scotland dissemminates itself as if it were a native, almost as freely as the Scotch pine. The tree, in its native habitats, is of a remarkably healthy and vigorous constitution, and, particularly so, De Candolle remarks, in the trunk, Larches are, he says, rarely attacked by the *Dermestes* (*Hylurgus*, see p. 214.), which is so formidable to pines and firs. (*Quart. Journ. of Agr.*, v. p. 406.) The wood of the larch is compact, and of a reddish or brown tinge; and, in favourable soils, is said to be fit for every useful purpose in 40 years' growth; while that of the pine requires 60 years, and the Scotch pine 80 years. The greatest drawback to the wood of the larch is its liability to warp. At Blair Adam, Ballinloch, and other places, the tree springs up from seeds

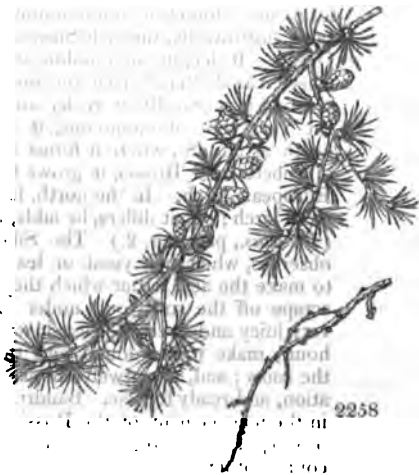

of the cones. Seed of an irregular or ovate form, fully $\frac{1}{4}$ in. long, and more than half surrounded by the smooth, shining, persistent pericarp. Cotyledons 5 to 7." (*Lans. Man.*, p. 383.) The cones are ripened abundantly in most parts of Britain, and the tree in many situations in Scotland dissemminates itself as if it were a native, almost as freely as the Scotch pine. The tree, in its native habitats, is of a remarkably healthy and vigorous constitution, and, particularly so, De Candolle remarks, in the trunk, Larches are, he says, rarely attacked by the *Dermestes* (*Hylurgus*, see p. 214.), which is so formidable to pines and firs. (*Quart. Journ. of Agr.*, v. p. 406.) The wood of the larch is compact, and of a reddish or brown tinge; and, in favourable soils, is said to be fit for every useful purpose in 40 years' growth; while that of the pine requires 60 years, and the Scotch pine 80 years. The greatest drawback to the wood of the larch is its liability to warp. At Blair Adam, Ballinloch, and other places, the tree springs up from seeds

ripened and shed in the plantations. (See *General Report of Scotland*, vol. iv. p. 476.)

The Rate of Growth of the Larch, in the climate of London, is from 20 ft. to 25 ft. in 10 years from the seed; and nearly as great on the declivities of hills and mountains in the Highlands of Scotland. In the course of 50 years, the tree will attain the height of 80 ft. or upwards; and, in its native habitats, according to Willdenow, it lives from 150 to 200 years. Dr. Bain planted between 500 and 600 acres of larches on his estate at Hefleton in Dorsetshire, between 1798 and 1808. Three of these trees, after being 12 years planted, were respectively 17 ft., 18 ft., and 20 ft. high, and 2 ft. 5 in., 2 ft. 8 in., and 3 ft. in circumference at the ground. Three larches, also planted in 1798, and measured in November, 1810, but on land of a better quality, were, respectively, 23 ft. 11 in., 23 ft. 9 in., and 24 ft. 6 in. high, and 2 ft. 5 in., 2 ft. 6 in. and 3 ft. in circumference. Dr. Bain obtained the gold medal of the Society of Arts for this plantation. (See *Transactions, &c.*, vol. xxix., p. 25.) The increase of a larch 22 years' old, in the New Forest, Hampshire, Mr. Davis of Portway House informs us, was as follows:—It was planted in 1805; in 1813, the trunk, at 1 ft. from the ground, measured 1 ft. 9½ in. in circumference; in 1816, it measured 2 ft. 6½ in.; in 1820, 3 ft. 3½ in.; and in 1827, 4 ft. 2½ in. The increase of timber during the last seven years, of a portion of the trunk 12 ft. in length, is, to the increase in the first seven years, as 11 is to 7. The annual increase of the larch, in Scotland, has been ascertained to be at the rate of from 1 in. to 1½ in. in circumference, at 6 ft. from the ground, on the trunks of trees from 10 to 50 years of age. (*Communications to the Board of Agriculture*, vol. i. p. 5.) In Perthshire, larches at 47 years' growth, measured 30 in. in diameter, or 942 in. in circumference, at 5 ft. from the ground; thus giving rather more than 2 in. of annual increase from the first planting. (*Perthshire Report*.) A larch at Blair Drummond, near Stirling, at 54 years of age, measured 78 in. in circumference at 6 ft. from the ground; giving an annual increase from the first planting of near 1½ in. Being measured again 18 years afterwards, it was found to measure 88 in. at the same height, having gained in that period little more than ½ in. annually. (*Gen. Report of Scotland*, vol. ii. p. 256.) At Athol and Dunkeld, the average growth of the larch, at 8 years from the seed, is 11 ft.; and the average annual growth, till the 50th, is 6 in.; and, after that period, 10 in. per annum for 22 years longer; so that the average of trees 72 years of age is 93 ft. 4 in., which agrees with actual experience. The larch differs from the spruces and silver firs in growing rapidly when it is young, and slowly after it has attained the height of 40 ft. or 50 ft.; while the spruces and silver firs grow slowly when they are young, and rapidly after they have attained from 15 to 20 years' growth. The growth of the larch has been remarkably rapid at different places in Inverness-shire and Morayshire. The following tabular view of the progress made by six trees, in the course of 70 years, at Ballindalloch, in the latter county, has been obligingly communicated to us by Macpherson Grant, Esq., the proprietor.

Girts of Larches at Ballindalloch, planted in 1767, and measured in August, 1837.

No.	At 1 Foot.	At 6 Feet.	At 12 Feet.	At 18 Feet.	At 24 Feet.	At 30 Feet.	At 36 Feet.	At 42 Feet.
1.	5 R. 6½ in.	8 R. 5 in.	8 R. 4½ in.	6 R. 6½ in.	6 R. 6½ in.	5 R. 1 in.	4 R. 7½ in.	4 R. 1½ in.
2.	5 7½	7 1	6 4	5 0	5 4	4 11	4 9	4 5
3.	10 6	8 4	7 1	6 6½	5 9	4 11	4 9	4 5
4.	8 2½	7 0	6 7½	5 3	5 0	4 6	4 1	4 1
5.	9 1	7 3	6 5	6 4½	5 6	4 9	4 1	4 1
6.	8 6	6 10½	6 5	6 0	5 6	4 9	4 1	4 1

The rate of growth of the larch, as compared with that of the silver fir, and the platanus, is thus given by the Earl of Fife, in February, 1803:—“A silver fir, a larch, and a platanus, were planted in the park at Duff House, near the river, in the year 1758. The larch, which stood in the middle, was overcome by its two powerful neighbours, and was in a declining state.

I then desired it might be cut down, but not sold. My carpenter cut it into deals that measured 10 ft. in length, and 1 ft. 10 in. in breadth, and made out of it a dining-table large enough for fourteen people, and two very good breakfast-tables. It is very little inferior in appearance to mahogany. The silver fir measured at 18 in. from the root, is 7 ft. 10 in. in circumference, and its height is 65 ft. The platanus, at the same distance from the root, measures 7 ft. 3 in. in circumference, and at 6 ft. above, 6 ft. 5 in. Its height is 55 ft." (*Trans. Soc. Arts*, vol. xxi. p. 102.)

The finest Larches in the neighbourhood of London are at Kenwood and Syon; at both which places they are upwards of 90 ft. in height; but the largest in Britain are supposed to be those at Dunkeld and Monzie, planted in 1738. The largest larch at Kenwood is drawn up among other trees, as will be seen by the portrait of it in our last Volume; but those at Syon preserve the drooping character of the trees, as will be seen by *fig. 2259.* (to a scale of 1 in. to 50 ft.), taken from one of those trees, by Mr. Le Jeune, in the summer of 1837. The largest of the larches at Dunkeld was accurately measured by Mr. Blackadder, in 1831, when the tree had been 95 years planted, and found to be 100 ft. high, the circumference of the trunk 10 ft. 6½ in. at 5 ft. from the ground, and the cubic contents 368 ft. *Fig. 2260.* is a portrait of this tree, to a scale of 1 in. to 50 ft. The same year (1831), Mr. Blackadder saw the larches at Monzie; and the tallest of these he considered to be about 90 ft. high, and to contain about 250 cubic feet of timber. According to a statement in a newspaper, the tallest of these trees is now (1837) 102 ft. high; and its branches cover a space of above 100 ft. in diameter. A larch cut down at Blair, from which the coffin was made of that celebrated Duke of Athol who planted the larch so extensively at Dunkeld and Blair, measured 106 ft. in length. (See *Gard. Mag.*, vol. xi. p. 176.) One cut down near the cathedral of Dunkeld, about the year 1810, after it had been 60 years planted, was 110 ft. high, and contained 160 cubic feet of timber. At Dalguise, about 5 miles north from Dunkeld, are a few larches of the same age as those at Monzie and the large trees at Dunkeld. The measurement of one, taken by Mr. Tyrie, forester there, on the 20th November, 1837, is: circumference, at 3 ft. from the ground, 9 ft. 11 in., and at 30 feet, 6 ft. 10 in.; height, 95 ft. The soil is a dead sand. The oldest larches in Scotland are those at Dalwick, the seat of Sir John M. Nasmyth, near Peebles. (See p. 94.) There are nine larches at Dalwick, all of which were planted in 1725, by the grandfather of the present baronet; and the most remarkable of these is a singularly picturesque tree, which had one of its principal limbs shattered by lightning in 1820. Of the remains of this tree, known as the Great, or Crooked, Larch, *fig. 2261.* is a portrait, to a scale of 1 in. to 20 ft., taken from a drawing kindly lent to us by Sir John Nasmyth in 1836. The height of the tree is only between 40 ft. and 50 ft.; but the girth of the trunk above the roots is 19 ft.; immediately under the two great limbs, 15 ft.; and about the middle, 13 ft. *Fig. 2262.*, to a scale of 30 ft. to 1 in., is the portrait of another of the nine old larches at Dalwick, which is upwards of

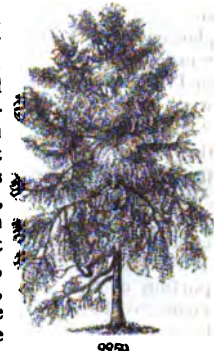

2259



2260

2261



80 ft. high, and 15 ft. in circumference above the roots, and which is called the Tall Larch. A larch at Kippenross, near Dumblane, in Stirlingshire, was measured by Mr. Blackadder in 1817, and again in 1832; when it was found to be 15 ft. higher than it was in 1817, and to contain 50 additional cubic feet of timber.

Geography. The European larch grows on the Alps of France and Switzerland, on the Apennines in Italy; on the mountains of Germany, principally in the Tyrol; in Hungary, and in different parts of the south of Russia. On the Alps, it is found at the elevation of 5000 ft., and on the Carpathian Mountains at that of 3000 ft. It is not found on the Pyrenees; nor in Spain, Sweden, Norway, or Britain. According to Hoss and Willdenow, it is found of the largest size in loamy soil, formed from the debris of granitic or slaty rocks; but it is also found of large size in calcareous soil; where the surface is kept cool by moisture. In ascending the Simplon from the Italian side, a part of the road passes through a larch forest, in which there were some immense trees in 1819, growing on the steep sides of the mountains; and in Mr. Bröckelton's grand and picturesque views of the Tyrol, from which *figs.* 2268. and 2264. are copied, the larch is, in all elevated and rocky situations, the prevailing tree.

History. The larch does not seem to have been known to the Greeks, as it is not mentioned by Theophrastus, or any Greek writer on plants; unless it be, as some suppose, the Greek *πίτυς*, though this does not appear pro-



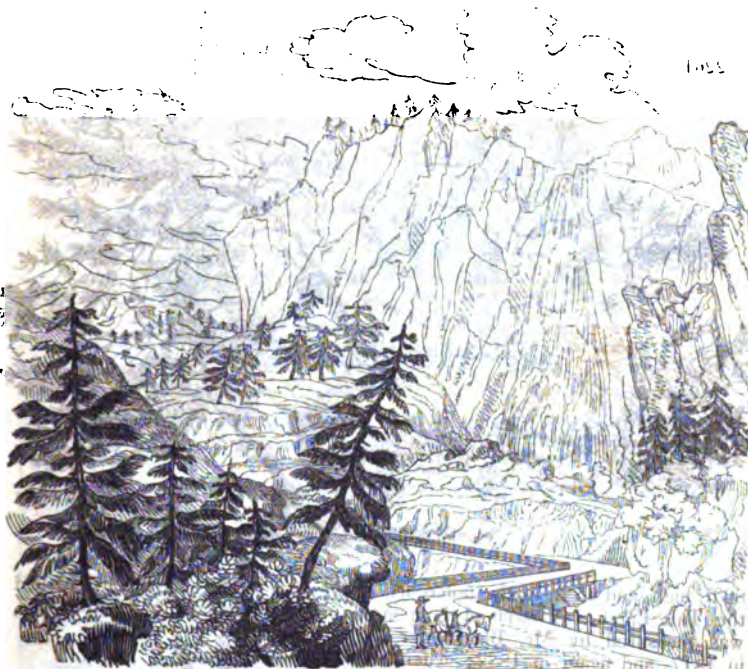

2263

bable. Pliny frequently mentions the larch; and, in his 16th book, has given the description of it which we have already quoted (see p. 2112.). In another place, he tells us that larch timber is not corruptible, like that of any other pine; and that, when set on fire, it burns more like a stone than a piece of wood, never causing flame. (Lib. xvi. c. 40.) He also says the tree never flowers. These exaggerated assertions have occasioned doubts to be expressed as to whether Pliny was really acquainted with the larch; but we find so many similar exaggerations and fabulous relations in his work respecting other trees, that we see no sufficient reason to doubt it. When Tiberius Cæsar built his Naumachia, or aquatic amphitheatre, for exhibiting a naval action as a public spectacle, an enormous larch was brought to Rome, which measured 120 ft. in length, and 2 ft. in diameter at the smallest end. This tree, of which Pliny says, "Amplissima arborum ad hoc ævi existimatur Romæ visa," Tiberius admired so much, that he would not permit it to be used as timber, but had it preserved as a curiosity for public admiration. Nero, however, had it cut up for an amphitheatre erected by him. The Forum of Augustus was built with larch wood, as were several bridges in Rome. Vitruvius mentions the larch, and attributes the decay of the buildings of Rome, erected in his day, to the circumstance of this wood being no longer used in their construction, the forests of the larch in the neighbourhood of Rome having been exhausted, and the builders not choosing to be at the expense of bringing the timber from a distance. He also says that the wood is so ponderous, that it will sink in water; and he repeats the assertions of Pliny as to its incorruptibility and incombustibility; adding that Julius Cæsar, wishing to set fire to a wooden tower, placed before the gates of a castle in the Alps, called Larigium, which he was besieging, heaped up logs of larch wood around it; which he attempted to ignite, but in vain. It is probably, in



2264

allusion to this, that Cæsar, in his *Commentaries*, speaks of the larch as "robusta larix, igni impenetrabile lignum." Several other wonders relating to the larch, and taken from ancient writers, are mentioned by Evelyn; one of which is, that the wood is so transparent, "that, in the dark night, when cabins made of the thin boards have lighted candles in them, people who are at a distance out of doors would imagine the whole room to be on fire!" (*Hunt. Evel.*, i. p. 310.) Evelyn also quotes from Witser (a Dutch writer on naval architecture) an account of a ship made of larch wood and cypress, which was found in the Numadian sea, 12 fathoms under water; and which, though it had lain 1400 years submerged, was yet quite hard and sound. In latter times, the wood of the larch appears to have been much used in Venice, both for piles and houses; and, in some very old mansions in that city, beams of larch have been found of enormous size, and showing no symptoms of decay.

The larch is mentioned, and very well described, both by Tusser and Gerard; but the first account we have of larch trees growing in Britain is in Parkinson's *Paradisus*, in 1629, where he speaks of the tree as "rare, and nursed up but with a few, and those only lovers of variety." Evelyn, in 1664, mentions a larch tree of "goodly stature, growing at Chelmsford, in Essex;" but the tree appears to have been still rare in his time. Miller, in the first edition of his *Dictionary*, published in 1731, says, "This tree is now pretty common in English gardens;" adding that there were then some large trees at Wimbledon, which produced annually a great quantity of cones. In the edition of 1759, he says that "the larch was then very plenty in most of the nurseries in England;" and, "of late years," there had been "great numbers of the trees planted;" adding that those which had been planted in "the worse soil and situations" had "thriven best." In confirmation of this, Mr. Gorrie informs us that, "on the rich and fertile soils on the braes of the Carse of Gowrie, Perthshire, which consist of strong black loams, yielding, with ordinary culture, five quarters of wheat per acre, the larch does not thrive nearly so well as farther north, on both sides of the Tay, where the soil is gravelly, or poor, inert, and somewhat moist sand; and hence there are no fine larch trees in that fertile district." Harte, in 1764, and again in 1770, in his *Essays on Husbandry*, speaks very highly of the larch, and strongly recommends its culture as a timber tree; a proof that then plantations were, at least, not common. In the *Account of the Larch Plantations on the Estates of Athol and Dunkeld*, published in the *Transactions of the Highland Society*, &c. (vol. xi. p. 169.), it is stated that Goodwood, the seat of the Duke of Richmond, near Chichester, was probably the first place where the larch was planted as a forest tree, and even there it was only in small numbers. In 1782, a very extensive plantation of larch was formed at Hafod. In 1786, we find the Society of Arts

awarding a premium to Mr. Thomas White, landscape-gardener, of Retford, Nottinghamshire, who had made a large plantation of forest trees (more than one half of which were larch) at Batsfield, in the county of Durham. (*Trans. Soc. Arts*, vol. iv. p. 5.); and, in 1788, the Society of Arts offered three gold medals, and a premium of 30*l.*, for planting the larch, and making known the useful properties of its timber. In consequence of the public attention being thus called to the tree, it has been more extensively planted in Britain, particularly since the commencement of the present century, than any other timber tree whatever, not even excepting the oak.

The introduction of the larch into Scotland is involved in some uncertainty. The crooked larch at Dalwick (see p. 2356.) is said to have been planted in 1725; but, according to Dr. Walker, whose attention to the history of exotic trees in Scotland is well known, the first larches were planted at Dunkeld in 1727. Sir Thomas Dick Lauder tells us that the popular account is, that the first larches introduced into Scotland were sent to the father of the late Duke of Athol in 1727; and the plants having arrived at Dunkeld along with some orange trees, and a number of other exotics, natives of Italy, they were all treated in the same way, and placed in a hot-house. The larches soon withered under this treatment; and, being supposed to be dead, were thrown out on a heap of rubbish in the garden. Being there covered with dead leaves and other rubbish, and aided by a wet season, they revived, and, sending forth shoots, soon became vigorous-growing trees. In the *Highland Society's Transactions*, vol. xi. p. 165., already mentioned, the following account is given of the introduction of the larch into Scotland:—“In the year 1788, Mr. Menzies of Migenny, in Glenlyon, brought a few small plants of the larch in his portmanteau from London, five of which he left at Dunkeld, and eleven at Blair in Athol, for Duke James,” the grandfather of the celebrated Duke of Athol already mentioned. It is probable that this account, of which one version states that the servant of Mr. Menzies carried the larches before him on his saddle, is quite incorrect; for we can hardly suppose that Dr. Walker would give the date of 1727 as that of the first planting of the larch at Dunkeld, without some positive evidence of the fact. Whatever may be the exact date of the introduction of the larch into Scotland, there can be no doubt that it was first extensively planted in that country by the Dukes of Athol at Dunkeld and Blair; and we shall here give a short account of these plantations to the reader, extracted from that in the *Highland Society's Transactions*, before referred to:—“Between 1740 and 1750, Duke James planted 350 larches at Dunkeld, at an elevation of 180 ft. above the level of the sea; and 873 at Blair, among limestone gravel, in a sheltered situation, which was worth from 20*s.* to 30*s.* per acre, at an elevation above the sea not exceeding 560 ft. All these larches were planted in the ornamental grounds around Dunkeld House and Athol House, the two residences of His Grace. So situated, and in regular rows wide apart, they were evidently intended more as a trial of a new species of trees than for forest timber. But, in 1759, Duke James planted 700 larches over a space of 29 Scotch acres, intermixed with other kinds of forest trees, with the view of trying the value of the larch as a timber tree. This plantation extended up the face of a hill from 200 ft. to 400 ft. above the level of the sea. The rocky ground of which it was composed was covered with loose and crumbling masses of mica slate; and was not worth above 3*l.* a year altogether. This may be considered the first attempt at mountain planting in Scotland. According to the fashion of the time, the trees were arranged in rows, and the rows converged towards a small piece of water in the centre, like radii. This concluded the whole attempts at planting of Duke James. Before he died, however, in January, 1764, he had tried the quality of the larch as timber, and was quite satisfied of its superiority over other firs, even in trees of only eighteen or nineteen years old.”

John Duke of Athol succeeded Duke James in 1764. “It was he who first conceived the idea of planting larch by itself as a forest tree, and of

planting the sides of the hills about Dunkeld. The former of these ideas was put into execution in 1768, by the planting of three acres with larches alone on Craigvinian, above the wood which Duke James planted on the same hill in 1759, at an altitude of from 100 ft. to 200 ft. above it; or 500 ft. or 600 ft. above the level of the sea, on soil that was not worth 1s. per acre. The latter idea of Duke John was effected by the enclosing of a considerable extent of ground for the planting of mixed wood at Dunkeld, and of near 300 acres at Blair, forming a total of 665 acres. Of these he finished the planting of 410 acres before his death in 1774.

"The greatest obstacle to the progress of the Duke John's planting was, the scarcity, and consequent dearness, of the larch plants. He had raised a few plants himself from cones gathered from some trees at Blair, which began to bear fruit at the commencement of his operations; but this supply did not exceed 1000 plants in a season. At the same time, three and four years transplanted larches were selling in the nursery grounds as high as 6d. per plant. All that could therefore be obtained for planting did not exceed fifty plants per acre in the large plantations; and the rest of the quantity, amounting to 4000 plants per Scotch acre (that being the allowance of plants to the acre at that time), were made up of the Scotch pine, and the different kinds of hard wood. The larch was planted at a height not exceeding 600 ft., and the Scotch pine at 900 ft., above the level of the sea. Another difficulty which the Duke John had to encounter was from the broom, furze, juniper, and heath, which flourished abundantly in the region allotted to the larch, and which had not been entirely eradicated before the planting began. The broom, though indicative of a good soil for larch, is a troublesome plant to young trees; its long switch-like elastic twigs whipping their tops violently in windy weather; and the furze, with its thick-set prickly branches, smothers, or draws up prematurely, the young plants. These, and many other obstacles, would no doubt have been removed by the Duke John, had he had leisure to attend to planting only; but, having been obliged to be frequently in London regarding his title, and the affairs of the Isle of Man, his attention was otherwise occupied for the greater part of the short time which he enjoyed his property. Such were the state and extent of the larch plantations at Dunkeld and Blair, when the late duke succeeded his father in 1774.

"The first object of this duke was to plant the 225 acres which formed a part of the plantations that were left unfinished by his father at his death in 1774. This, with some larches planted about the Loch of the Lows, occupied him till the year 1783. This delay was owing to the difficulty of obtaining larch plants, all the number that could be obtained during that time amounting only to 279,000.

"Observing the rapid growth and hardy nature of the larch tree, the duke determined on extending the sphere of its occupation to the steep acclivities of mountains of greater altitude than any that had yet been tried. Hitherto the larch had chiefly been planted along with other trees; but the duke enclosed a space including 29 acres, on the rugged summit of Craig-y-barns, and planted a strip consisting entirely of larch, among the crevices and hollows of the rocks, where the least soil could be found. At this elevation, none of the larger kinds of natural plants grew, so that the ground required no previous preparation of clearing. After 1774, larch plants fell in price from 6d. a plant to 3s. per thousand, two and three years transplanted, and ranging from 2 ft. to 3½ ft. in height. The expense of enclosing and planting at this time was the same as in the time of Duke John; namely, 1l. 19s. 1½d. per acre. This alpine plantation was formed in 1785 and 1786.

"From 1786 to 1791, the duke planted 480 acres at Dunkeld, the greater part of which was only sprinkled with larch from 6 ft. to 30 ft. in height, owing to the difficulty of procuring a sufficient number of plants; and 200 acres at Blair, which were planted wholly of larch, at 6 ft. apart. The number of larch plants consumed in these plantations in the five years was 500,000. Wages rising at this period, and there being a greater substitution

of larch for Scotch pine, the expense of planting was considerably increased. That, with the enclosing, amounted to 2*l.* 10*s.* 6*d.* per acre. The pitting alone cost 10*s.* 6*d.* per acre.

"In the eight years from 1791 to 1799, the duke still continued to diminish the number of Scotch pines in his plantations, and to increase that of the larch. During this time, the banks of the Bruar Water, extending to 70 Scotch acres around the beautiful waterfall, were planted. It is not unlikely that the humble petition of Bruar Water, —

"To shade its banks wth towering trees,
And bonnie spreading bushes,"

so well expressed in the words of the poet, might have had the effect of drawing His Grace's attention the sooner to the embellishment of this delightful spot. At Logierait, Inver, and Dunkeld, the space altogether planted extended to 800 acres, 600 of which were entirely of larch, but only planted so thinly, from a paucity of plants, as to leave after merely a scanty thinning, only a sufficient number of trees for naval purposes. The duke's desire to extend his plantations solely with the larch, in elevated situations, had to struggle very severely and painfully against the scarcity of plants that prevailed in the country, even at this period, when the value of the larch tree was begun to be appreciated. The expense of planting this piece of ground was the same as the last, and though the number of larch plants consumed in it only amounted to 800,000, even this number was obtained with great difficulty.

"Observing with satisfaction and admiration the luxuriant growth of the larch in all situations, and its hardihood even in the most exposed regions, the duke resolved on pushing entire larch plantations still farther to the summits of the highest hills. The Scotch pine, that was planted at 900 ft. above the sea, had the vacancies occasioned by deaths or accidents filled up, ten years afterwards, by the late duke, with larch, as an experiment. In 1800, when the duke was anxious again to extend his larch plantations, the effect of this experiment confirmed him in an opinion which he had previously conceived of the very hardy nature of the larch. These Scotch pines, in a period of nearly forty years, had only attained a height of five or six feet; while the larches, which had been planted among them ten years after, were from 40 ft. to 50 ft. high. Nine hundred feet was an elevation at which it was before supposed that the larch was incapable of vegetating. A favourable circumstance, too, happened in 1800, which concurred with the result of the above experiment to give an impulse to the commencement of a great undertaking in planting. In that year, several of the farms at Dunkeld fell out of lease; and, as they were all in miserable condition, His Grace took them into his own hands, to improve them, and to build suitable farm-houses and offices on them. This circumstance gave the duke the command of a range of mountains, extending from the edge of Craig-y-barns, over a space of ground of 1600 Scotch acres. This space included a common, the rights of which the duke bought up. It formed the background to the farms which the duke had taken into his own hands. It was situated from 900 ft. to 1200 ft. above the level of the sea. Its soil, presenting the most barren aspect, was strewed over thickly with fragments of rocks, and vegetation of any kind scarcely existed upon it. 'To endeavour to grow ship-timber,' remarks His Grace, 'among rocks and shivered fragments of schist, such as I have described, would have appeared to a stranger extreme folly, and money thrown away; but, in the year 1800, I had for more than twenty-five years so watched and admired the hardihood and the strong vegetative powers of the larch, in many situations as barren and as rugged as any part of this range, though not so elevated, as quite satisfied me that I ought, having so fair an opportunity, to seize it.'

"During the same period in which the duke planted this mountain range, he also planted 400 acres in other situations; making a total of 2400 Scotch acres, 1800 of which consisted solely of larch, and 600 acres of this occupied a region far above the growth of the Scotch pine. These plantations, in entire-

ing and planting, occupied the long period of years from 1800 to 1815. This delay arose greatly from the difficulty of obtaining larch plants, and which only permitted them to be planted to a thickness of from 1500 to 1800 per acre. From a different mode of planting being adopted, however, and the selection of plants of an earlier age (an account of both of which will be hereafter given), the cost of fencing and planting this extensive range of ground did not exceed 10s. 6d. per acre.

“ Having now no doubt whatever of the successful growth of the larch in very elevated situations, the duke still farther pursued his object of covering *all* his mountainous regions with that valuable wood. Accordingly, a space to the northward of the one last described, containing 2959 Scotch acres, was immediately enclosed, and planted entirely with larch. This tract, lying generally above the region of broom, furze, juniper, and long heath, required no artificial clearing. An improved mode of planting was employed here, that of using young plants only, two or three years' seedlings, put into the ground by means of an instrument invented by the duke, instead of the common spade. This change of arrangement facilitated the operation, and, at the same time, greatly increased the supply of the plants, so as to enable the whole ground to be planted in three years, from the 4th of December, 1815, to the 2d of December, 1818. The increased number of plants per acre, and the high price of the plants, enhanced the cost to 16s. 8d. per acre, for enclosing and planting this forest of Loch Ordie, so named from a beautiful sheet of water in it, of 100 acres in extent.

“ In 1824, the growth of the larch in Loch Ordie Forest having greatly exceeded the sanguine hopes and expectations of the duke, he determined on adding to it an extensive adjoining tract, consisting of 2231 Scotch acres, denominated Loch Hoishnie. The preparations of fencing, clearing (where that was necessary), making roads, and procuring plants from different nurserymen, occupied the time till October, 1825, when the planting commenced, and was carried on in such good earnest, that the whole was finished by December, 1826. The fencing and planting cost 15s. per acre. There was no plantation which His Grace had executed that gave him so much satisfaction in the work, as that of the Forest of Loch Hoishnie.

“ The planting of this forest appears to have terminated the labours of this duke in planting; and the following table will show at a glance the extent of the larch plantations executed by the different noble dukes, and which will form a summary of what has been stated above:—

	Number of Larches, exclusive of the other plants mixed with them.	Number of Larches planted without mixture.	Acres of entire Larches.
Duke James planted, at Dunkeld and Blair, in 1738	16		
.. .. . to 1750	350		
.. .. . to 1759	1,575		
Duke John planted, at Dunkeld and Blair, from 1766 to 1774	11,400		
The late Duke John, 1774 to 1783	579,000		
.. .. . 1783 to 1786	—	43,500	29
.. .. . 1786 to 1791	20,000	490,000	459
.. .. . 1791 to 1799	570,000	2,250,000	600
.. .. . 1800 to 1815	250,000	2,250,000	1800
.. .. . 1816 to 1818	—	5,982,000	2261
.. .. . 1824 to 1826	—	4,028,880	2231
	1,122,339	12,974,380	8071

“ The total amount of larch plants, mixed or unmixed with other kinds, will thus amount to the enormous number of 14,096,719 plants; and, if we allow 2000 plants per acre for the amount that was mixed with other kinds of trees, these would occupy a space, if planted alone of larch, of 533 acres, so that the whole extent of ground occupied by larch amounts to 8604 Scotch acres, or 10,324 acres imperial.

“ There is no name that stands so high, and so deservedly high, in the list of successful planters, as that of the late John Duke of Athol. His Grace planted, in the last years of his life, 6500 Scotch acres of mountain ground *solely with the larch*, which, in the course of seventy-two years from the time of planting, will be a forest of timber fit for the building of the largest class of ships in His Majesty's navy. Before it is cut down for this purpose, it will have been thinned out to about 400 trees per acre. Each tree will contain at the least 50 cubic feet, or one load of timber; which, at the low price of one shilling per cubic foot (only one half of its present value), will give 1000*l.* per acre; or, in all, a sum of 6,500,000*l.* sterling. Besides this, there will have been a return of 7*l.* per acre from the thinnings, after deducting all expense of thinning, and the original outlay of planting. Further still, the *land* on which the larch is planted is not worth above from 9*d.* to 1*s.* per acre. After the thinnings of the first thirty years, the larch will make it worth at least 10*s.* an acre, by the improvement of the pasturage, upon which cattle can be kept summer and winter.”

On this passage Mr. Gorrie remarks :—“ The prospective value of the timber and improved pasturage, as here stated, will seldom be realised, even on the best mountains or moorlands in Scotland; but larch is certainly by far the best improver of heath or moor pasturage yet known in this country. To effect such improvement in little time, the plants should at first stand so close as to choke the heath and coarser grasses; when this is accomplished, as may be done in from 10 to 15 years, gradual thinning will be followed by the *Festuca ovina* and *duriuscula*, *Cynosurus cristatus*, *Agrostis vulgaris*, *Poa compressa*, &c. &c., with the foliage possessing a softness and luxuriance not acquired in open situations. Seeds of the *Poa nemoralis*, scattered over the ground after removing the first thinnings, would wonderfully improve the pasture.”

About the year 1777, Dr. Anderson, under the name of Agricola, strongly recommended the larch as a timber tree; and, in consequence of the popularity of his writings, the tree began, before the end of the last century, to be planted in the north as much as, or more extensively than, the Scotch pine, which had till then been the principal tree planted in Scotland. One of the greatest planters, at this time, in Scotland, was the Earl of Fife, as may be seen by the various letters written by His Lordship respecting his plantations, in the early volumes of the *Transactions of the Society of Arts*; and he also planted a great many larches. At the present time, as Sir Thomas Dick Lauder has remarked, Scotland is preeminently the country for the larch; and at Dunkeld, Blair, Monzie, and Gartmore, in Perthshire; at Alloa, in Stirlingshire; at Paumure and Brechin Castle, in Forfarshire; at Cullen House (Lord Fife's), in Banffshire; at Gordon Castle, Ferness, and Tarnawa, in Morayshire; at Ballindalloch, in Inverness-shire; at Dalwick, in Peeblesshire, and at many other places in Scotland; larches are to be found which have all the boldness of character of the tree in its native Alps.

Early in the present century, the larch, both in England and Scotland, was, in many places, attacked in its foliage by a white woolly aphid, commonly known as the *Aphis lárícis*; and, from 1820 to the present time, it has been found that, when larches have grown on certain soils, the wood is apt to decay, and become hollow at the heart; a disease which, in Scotland, is called pumping, from the trunks of trees affected by it conveying the idea from their hollowness, of their being fit for pumps, or pipes for conveying water under ground. The insects have long since disappeared; but the decay of the timber at the heart continues, and has led to much more attention being paid to the soil in which the tree is planted; the disease having rendered it evident that the larch is, perhaps, more powerfully affected by soil and situation than any other timber tree. In order to ascertain how far the effect of change of seed might prevent this disease, the Highland Society of Scotland have offered premiums for the greatest quantity of seed imported from the native larch forests of Switzerland and the Tyrol; and many trees, raised from seeds so imported,

by Messrs. Lawson and Son of Edinburgh, have been planted in different parts of the country. The larch, ripening abundance of seeds in Britain, is now raised in larger quantities by the Scotch nurserymen than any other timber tree; and there is scarcely any Scotch proprietor, of the mountainous districts more especially, in whose plantations the larch is not the prevailing species. In Ireland, it is also a favourite tree in the elevated regions; though the extent to which it has been planted in that country is trifling, when compared with either Scotland or England.

In France, the larch does not appear to have been planted to any considerable extent; though De Candolle mentions having seen flourishing plantations of this tree in the Vosges. Malesherbes, in 1778, having seen some houses in the Vallais, which had been constructed of this wood 240 years previously, examined the timber, and found it not only perfectly sound, but so hard that he could not penetrate it with the point of a knife. In 1798, M. Boissel de Monville conveyed a number of trunks of larch to Toulon, with a view to their being used in the construction of ships for the French navy; and they were examined for that purpose by the Commissioners of the Marine, on the 6th of August in that year. The result, as reported by Desfontaines, in his *Histoire des Arbres, &c.*, was: 1. That the wood was more resinous than that of *P. Laricio*, though, at the same time, it was much lighter, in the proportion of 25 or 26 to 29: 2. That the fibres of the larch were very strong, and well able to resist twisting: and, 3. That branches clear from knots might be used for topmasts; but that trees must not be chosen for this purpose which were either standing singly, or in thin plantations; because, in the one case, their trunks were likely to be strained by the wind, and in the other to be injured by the multiplicity of branches causing knots. Notwithstanding the favourable nature of this report, it appears from Malesherbes and others, that all the previous experiments made with regard to using the larch for the masts of large vessels were unsuccessful; principally because the tree, when of sufficient height, was never found of sufficient thickness. To remedy this defect, Varennes de Fenille suggested the thinning of the native forests, to allow the trees to acquire greater bulk of trunk; but it was found that, instead of this being the case, it encouraged them to throw out branches; and the wood, consequently, became full of knots. Baudrillart, in 1835, warmly recommends planting the larch in the forests of the north and middle of France, and especially in mountainous situations; quoting from Martyn's *Miller* what had been done in Scotland by the Dukes of Athol and others. Delamarre, in 1831, acknowledges his own want of experience in this tree; and states that in Normandy, in his neighbourhood, the larch had been planted to some extent; and that, after 40 years' trial, the rate of growth was not satisfactory; and that the trees had the great disadvantage of not disseminating themselves by their seeds, like the pine and fir tribe. Near Coutances, in Normandy, M. le Comte de Rambuteau has formed a plantation of larches on a grand scale, with a view to study the value of that species as a timber tree. In Germany, the larch has been introduced into plantations in Wirtemberg, Bavaria, and some other states; but, as it is indigenous in several districts, as well as in Poland, it is less planted than might have been expected. De Candolle mentions that M. De Charpentier expresses admiration of the magnificent plantations of larches at Moritzburg and at Thorauz, near Dresden; which are only 238 ft. above the level of the sea. They grow in sands almost pure, not marshy, but habitually and moderately moistened by the filtrations from large ponds in the neighbourhood; and, at 40 or 50 years' growth, they rival in size the most beautiful larches of the Vallais.

Poetical Allusions. These are very few. The larch does not appear to have been mentioned by any of the Greek poets, and by few of the Roman ones. A supposition has, indeed, been broached, that the trees into which Ovid describes the sisters of Phaethon to have been turned were neither poplars nor alders, but larches. This supposition appears to have been founded on the circumstance of a Roman medal having been found with three larches as

it, and on the following lines in Ovid, which seem to allude to some resinous tree, —

“The new-made trees in tears of amber run,
Which harden into value by the sun.”

Lucan tells us that the “gummy larch” was one of the articles burnt to drive away serpents. Among the British poets, Ben Jonson mentions the larch. A witch says, —

“Yes, I have brought to help your vows
Horned poppy, cypress boughs,
The fig tree wild that grows on tombs,
And juice that from the larch tree comes.” *Masque of Queens.*

Properties and Uses. The wood of the larch, according to Hartig, weighs 68 lb. 18 oz. per cubic foot when green, and 36 lb. 6 oz. when dry; and according to Kasthoffer, it lasts four times longer than that of any other species of *Abietina*. That of trees produced in a good soil is of a yellowish white; but that of trees grown in a cold and elevated situation is reddish or brown, and very hard. In a suitable situation, the timber is said to come to perfection in 40 years, while that of the pinaster requires 60 years, and that of the Scotch pine 80 years. (*Trans. Soc. Art.*, vol. xxix. p. 25.) Though the wood of the larch ignites with difficulty, and a fire made of it will, if not attended to, extinguish itself before the wood is half-consumed, yet, if properly managed, the wood of old trees is capable of producing an intense heat; and M. Hartig ranks it, in comparison with that of the beech, as 1248 to 1540. The charcoal of the larch, according to M. De Werneck, is more rich in carbon than that of either the spruce or the silver fir, but less so than the pine or the beech; being as 6409 to 7299 for the pine, and 6409 to 7871 for the beech. The charcoal of the larch is very heavy, and weighs 16½ lb. (7½ kilogrammes) per cubic foot: it is said to be excellent for iron founderies. The bark of young larches is astringent, and it is used in the Alps for tanning leather; where the leaves and young shoots are sometimes given to cattle. The only objections which have been made to the wood of this tree in Britain are, according to Monteath, its being so remarkably hard to season, that it is almost impossible to keep it from bending and twisting; and that, when it is properly seasoned, it is so very hard, that it is difficult to work, and more especially to be smoothed on the surface with the plane. To remedy the evil of twisting, some adopt the method of steeping it (whilst in the log) in water for twelve months, and then taking it out, and drying it for twelve months more, before cutting it up. Steaming has also been resorted to for the same purpose; but Monteath prefers a practice which has been often recommended, though but little employed, viz. that of barking the tree standing, and then leaving it a year before it is cut down.

The Uses of the Wood of the Larch in France and Switzerland. According to Varennes de Fenille, the disposition of the fibres of the wood resembles that of the silver fir; and each annual layer consists of a zone of very hard wood of dark orange, and a zone of softer wood which is of a pale orange or yellow. The Président de la Tour d'Aigues, who has written copiously on the uses of the larch, says: “The wood is not filled with knots, like that of the spruce fir: it is excellent for carpentry; beams made of it are very strong, and not subject to rot; it may be employed safely in damp places, as, for instance, in cellars; and it will remain sound and uninjured, even when resting on the earth.” According to Rozier: “Every one who knows the larch agrees that it is the best of all the different kinds of wood, whether for the carpenter or the cabinet-maker. Its strength is at least equal to that of the oak. The Germans make casks of it, which may be said to last for ever, and from which the spirituous particles of the wine are hardly ever found to have evaporated. In Upper Dauphiné, Savoy, and the Pays de Vaud, houses are built of it, by placing squared trunks, of the thickness of 1 ft., one upon another, in the manner of building log-houses. (See p. 2123.) The heat of the

sun melts the resin contained in the wood, which, running down the sides, fills up the interstices between the logs; and the edifice, thus rendered impenetrable to air and moisture, will last for centuries without alteration." This tree, says Malesherbes, "is the highest, the straightest, and the most incorruptible of all the Swiss indigenous woods. It is excellent for all purposes; and is so much sought after, that, in several cantons of Switzerland, a piece of larch wood costs double the price of a piece of oak wood of the same dimensions." Notwithstanding this, the same author adds that, after many experiments, the wood of the larch has been found unsuitable for masts. (See p. 2364.) No wood remains uninjured by water longer than the larch; and, for this reason, it is in general use, in France and Switzerland, for water-pipes. At Aix, Marseilles, and throughout the greater part of Provence, where the land is frequently irrigated, the pipes used to convey the water to the ground are always of larch. In Provence, it is also much used by the cabinet-makers, as, from the closeness of its grain, it takes a fine polish. (*Novv. Du Ham.*) Desfontaines, in his *Histoire des Arbres et Arbrisseaux*, gives a very interesting report made by M. Boissel de Monville on the uses of the larch. This account confirms what previous writers had asserted respecting the durability of the cottages in the Vallais; and adds that larch wood is much used, in Switzerland, for shingles to cover the roofs of the houses, and for vine props. For the latter purpose, it is found the most durable of all kinds of wood: the vine props made of it are never taken up; they remain fixed for an indefinite succession of years, and see crop after crop of vines spring up, bear their fruit, and perish at their feet, without showing any symptoms of decay. In most cases, the proprietors of the vineyards are perfectly ignorant of the epoch when these props were first placed there: they received them in their present state from their fathers, and in the same state they will transmit them to their sons. Props made of the silver fir, and used in the same soil for the same purpose, would not last more than ten years. In traversing the forests of the Alps, continues M. Boissel, "I found frequent proofs of the excellence of the wood of the larch. The lightning often strikes and shatters these trees, the winds break them, and the effects of time cause them to perish by old age; all these modes of destruction, and many others, made me find a great number of mutilated and dead trees in these forests. Those which were mutilated had not perished on that account. The branches which remained uninjured were still growing with vigour; the heart wood was sound and unchanged; and the tree continued to live during a long series of years. The wood, even of those quite dead, showed no signs of decay, and had evidently remained in the same state a great number of years. I gathered several of the branches, and divided some of the trunks of the dead trees; and, though some of the branches were become so brittle as to break easily with the fingers, and the wood of the trunks so dry as to separate into scales, neither showed the least signs of rottenness. The silver fir, on the contrary, when broken or shattered by lightning, soon perishes; and the wood of dead trees, in the course of a few years, becomes quite rotten." (*Hist. des Arb., &c.*, ii. p. 603.) The fine grain of the larch wood, its durability, and its not being subject to crack, have long made it used by painters for their palettes, and even to paint their pictures on. According to Pliny, it was employed for this purpose by the ancients (lib. xvi. c. 39.); and Evelyn tells us that several of the paintings of Raphael are on larch wood.

The resinous Products of the Larch are, Venice turpentine, and the manna de Briançon; and both are used in the state in which they are procured from the tree. To obtain the turpentine, trees are chosen which are neither too young nor too old; as only full-grown trees, not yet in a state of decay, will yield good turpentine. When the sap begins to be in motion in spring, if a few drops of turpentine are seen exuding from the bark, it is a proof that the tree is full of resinous juice; and, if the trunk were split, there would be found, 5 in. or 6 in. from the heart of the tree, and 8 in. or 10 in. from the

bark, several depots of liquid resin, contained in cavities which are sometimes 1 in. thick, 3 in. or 4 in. broad, and as much in height. In a trunk of 40 ft. in length, as many as six of these large reservoirs of liquid resin have been found, and several smaller ones. When the wood of a tree cut down in this state is sawed up, a cut with a hatchet will make the turpentine flow abundantly; and the sawyers often find the movement of the saw impeded by it. Young and vigorous larches have none of these reservoirs, which appear not to be formed till the tree has attained its full growth; and it is consequently in this state only that the tree is in a fit condition for being pierced for the extraction of its resin. The peasants of the Valley of St. Martin, in the Pays de Vaud, use augers nearly an inch in diameter, with which they pierce the full-grown larches in different places, beginning at 3 ft. or 4 ft. from the ground; and mounting gradually to 10 ft. or 12 ft. They choose, generally, the south side of the tree, and, where practicable, the knots formed by branches which have been broken or cut off, and through which the turpentine is seen exuding naturally. The holes are always made in a slanting direction, in order that the turpentine may flow out of them more freely; and care is always taken not to penetrate to the centre of the tree. To these holes are fixed gutters made of larch wood, which are $1\frac{1}{2}$ in. wide, and from 15 in. to 20 in. long. One of the ends of each gutter terminates in a peg, through the centre of which is bored a hole about $1\frac{1}{2}$ in. in diameter. This end of the gutter is forced into the hole made in the tree, and the other end is led into a small bucket, or trough, which receives the turpentine. In the countries where larches are abundant, says Du Hamel, particularly in the Briançonnais and the Vallais, may be seen, in the fine weather of spring, a prodigious quantity of little buckets at the foot of the trees, each attached to a tree by a slender tube, or gutter, through which the clear limpid turpentine, glittering in the sun, trickles down, and soon fills the bucket; while every morning and evening, the peasants hasten from tree to tree, examining their buckets, taking away or emptying those that are full, and replacing them with empty ones. This harvest, if so it may be called, continues from May till September; and the turpentine requires no other preparation, to render it fit for sale, than straining it through a coarse hair cloth, to free it from leaves, or any other accidental impurities that may have fallen into it. When a hole made in a tree does not produce turpentine, or when the turpentine ceases to flow, the hole is stopped with a peg, and not opened for a fortnight or three weeks. When these holes are reopened, the turpentine is generally found to flow from them in greater abundance than from the other holes in the tree, and they continue to give still more and more, till the flow of the sap is stopped in autumn by the cold. A full-grown healthy larch, if tapped when of the proper age, will yield 7 lb. or 8 lb. of turpentine every year, for 40 or 50 years.

The wood of a tree from which the resin has been extracted is never used for building purposes: it is, indeed, only good to burn; and the charcoal made from it is very much lighter than, and very inferior in every respect to, that made from larches which have not been deprived of their resin. The turpentine of the larch is called Venice turpentine, because it used formerly to be sent to England and the north of Europe only from that commercial city. It should be clear, transparent, free from all impurities, of the consistence of a thick syrup, with a bitter taste, and a strong disagreeable smell. It is employed in medicine, and particularly in veterinary surgery; and it is reckoned excellent to draw out thorns, splinters, &c., and to cure ulcers and old wounds which appear to be in danger of gangrene. It is used in the formation of what are called drawing plasters, and also for making several kinds of varnish. It is sometimes distilled with the addition of water, like the turpentine of the pinaster; but its essential oil, colophony, &c., are very inferior to those produced by distilling the turpentine of any other of the pine and fir tribe.

The Manna of Briançon is a kind of sap of a sweetish but insipid taste,

which, towards the end of May, and during the months of June and July, exudes, according to some, during the night, from the bark of the young shoots; but which, according to others, transpires from the buds and leaves, on which it coagulates in the form of little white glutinous grains, which are easily scraped off. In the morning, young larch trees, before they are struck with the rays of the sun, will be found covered with it; but the grains, if not gathered, will soon disappear. Very cold winds prevent the formation of this substance, which is called *manne de Briançon*, because it is found in most abundance in that country. It resembles the manna of the flowering ash (*O'rnus rotundifolia*, see p. 1242.), but is less purgative. It is not much used, as but very little is produced, except in Briançon; and, even there, it is very difficult to collect before it melts.

The Leaves of the larch, Kasthoffer considers as less injurious to pasture than those of any other pine or fir; and, for the same reason, he says that they are better worth collecting as a manure. They are eaten in Switzerland by cattle and sheep, but less eagerly than those of the evergreen pines and firs; because they, being deciduous, are only to be found in an eatable, that is green, state, when the more palatable food of grass is abundant.

Uses of the Larch in Britain. Public attention was first drawn to the uses of this tree, as we have already observed, by Dr. Anderson, in 1777, when the oldest larch trees in Scotland could not have been above 50 years old, and, doubtless, none of them had been cut down; as the earliest notice of one of the Athol larches having been felled is in that year. (See *App. to Gen. Rep. of Scot.*, vol. iv. p. 493.) Dr. Anderson's sources of information, therefore, must have been foreign authors, the more important of whom have been already quoted. The first British author who treats of the value of the wood of the larch at length, and from his own experience, is Pontey; who, in his *Forest Pruner*, the first edition of which was published in 1805, states that the larch excels foreign fir in all the following respects:—

"1. It is much clearer of knots, provided a very small degree of attention be paid to it, during the first twenty years of its growth.

"2. It is more *durable*; for though it produces dead knots, when neglected, still it produces no rotten ones, or what carpenters call cork-knots. The fact is, that not only the heart and sap of the wood, but even the bark, are so durable a nature, that we know no means of estimating when any one of them will decay, except under some species of mismanagement. There is a particular criterion by which larch is distinguishable from any other wood, which is, at the same time, a decisive proof of its durability; viz. the dead knots, or branches, wood and bark, being always found fast *wedged*, as it were, in the timber; so that every knot of that description has a sort of ring round it nearly black. Any person who has larches growing, of some tolerable age, may convince himself of their durability, by examining their dead branches; which, whether great or small, *are never found rotten*.

"3. Larch is much less liable to shrink than foreign deal. It is well known that the latter is exceedingly liable to that defect, in the first instance; and the joiners tell us that, when a board of it has been twenty years in use, if planed over again, it will again shrink: but not so with larch; for, if well dried at first, it never shrinks at all.

"A piece of *larch wood*, split from the root end of a slab, was weighed at different periods. The tree having been cut down in August preceding, and sawn up a few days previous to the first weighing, gave the following results:—

Date when weighed.	lb.	oz.	Date when weighed.	lb.	oz.
"1799, 1st October - - -	12	11	"1799, 9th December, - - -	7	11
19th October - - -	10	6	30th December, - - -	7	9
25th October - - -	9	0	1800, 31st January, - - -	7	9
13th November, - - -	7	13			

"The weighing has often been repeated since, but no variation was found while it was in the same place; namely, a dry room over one where a good fire was kept. The piece is nearly all sap wood. From which we gather

this important information; the larch may be perfectly seasoned in three months, with a very moderate heat, and probably much sooner, as the next circumstance to be noted seems to show. When wood can lose no more weight, we take it for granted it is perfectly seasoned; and, as this is so soon attained by the larch, there can remain no just apprehensions of its shrinking.

"4. Larch will not crack, with any degree of heat that can be called tolerable, when in plank or boards, or when the poles are split as rails. When in bulk (that is not sawn up), the case is not different, provided the bark remains upon it; but if *that* be taken off while the wood is green, it cracks considerably, as will be noticed under the seventh head.

"5. Larch is much more tough than foreign deal. It splits with great difficulty, and never in any length with the grain. Foreign deal being so exceedingly apt to split, can seldom be used very thin; but the larch may be used as thin as the sawyers can cut it, without any danger on that head.

"6. It has two properties, the first of which the foreign deal does not possess, and the second but in a very inferior degree; namely, its beautiful colour, and its capability of receiving a degree of polish equal to any wood yet known, and much superior to the finest *mahogany*.

"7. It may be used in situations where the best foreign deal proves of very short duration; namely, as posts for every description of fencing."

The knotty tops of some larch trees were sawn, in 1800, into scantlings of about 1½ in. square, for the purpose of staking and tying up plants in Mr. Pontey's nursery. On examining their condition four years afterwards, the whole of them were perfectly sound above ground, the only symptoms of decay appearing on the sappy parts of the wood, that had been in the ground. A larch post, which, in 1800, had been in the ground upwards of 20 years, was perfectly sound above ground, and not decayed under it deeper than the sap wood; and, where the bark was not removed under ground, even the sap wood was uninjured. (*For. Prun.*, ed. 4., p. 83.)

Matthew is the next British author who writes on the uses of the larch from his own experience; and his work *On Naval Timber* is dated 1831. The larch, compared with pines and firs, he says, has the timber much stronger when young, and even when the trunk is under a foot in diameter, than when old and large. Near the top of the tree, the timber is very inferior, and deficient in toughness, to what it is at the root. The wood is finer grained, and has fewer large knots, than that of the Scotch pine. A thin larch board, when dried, is at once strong, tough, durable, and extremely light. It is difficult to split larch even by wedges; which is owing to the netted structure of the fibres of the wood: whereas the wood of the Scotch pine, as of other pines, is easily split, owing to its reedy structure, the longitudinal fibres running parallel to each other, with comparatively very few transverse ones. Some experiments conducted at Woolwich, which will be hereafter given, show the strength of Highland larch to be to that of the Riga pine as 1000 to 804; and to that of white American pine (*P. Strôbus*), as 1000 to 824. In Scotland, it is universally allowed to be stronger than the Scotch pine; as a proof of which, the sawyers employed to cut it up have one fourth more pay when cutting larch, than when cutting pine. The larch, compared with any other of the Coniferæ, *Matthew* justly observes, "has comparatively smaller and more numerous branches; and, consequently, the timber is freer from large knots, and has more equable strength, as well in small spars, as when large and cut into joists and beams; provided the timber be not too far up the tree." (*On Naval Timber*, p. 105.) The larch, says Mr. Sang, will arrive at a useful timber size in one half or a third part of the time, in general, which the Scotch fir requires; and the timber of the larch, at 30 or 40 years old, when placed in soil and climate adapted to the production of perfect timber, is in every respect superior in quality to that of the fir at 100 years old. (*Plant. Kal.*) The price of the wood of the larch, in Scotland, at the present time (1837), varies from 2*d.* to 4*d.* per cubic foot more than that of the Scotch pine.

"The larch," Sir Thomas Dick Lauder observes, "is unquestionably by much the most enduring timber we have. It is remarkable, that, whilst the red wood, or heart wood, is not formed at all in the other resinous trees till they have lived for a good many years, the larch, on the other hand, begins to make it soon after it is planted; and, whilst you may fell a Scotch fir of 30 years old, and find no redwood in it, you can hardly cut down a young larch large enough to be a walking-stick, without finding just such a proportion of red wood, compared to its diameter as a tree, as you will find in the largest larch in the forest compared to its diameter." (*Laud. Gilp.*, i. p. 153.)

For *Naval Purposes*, Matthew observes, the larch, from its general lateral toughness (particularly the root), and from its lightness, seems better adapted for the construction of shot-proof vessels, than any other timber." It has been used for ship-building in the Tay, he says, since 1810; and there were, in 1830, several thousand tons of shipping constructed of it. "The Athole frigate, built of it about 1818; the Larch, a fine brig, built by the Duke of Athole several years earlier; and many other vessels, built more recently; prove that larch is as valuable for naval purposes as the most sanguine had anticipated. The first instance we have heard of British larch being used in this manner was in a sloop repaired with it about 1808. The person to whom it had belonged, and who had sailed it himself, stated to us, immediately after its loss, that this sloop had been built of oak about 36 years before; that at 18 years old her upper timbers were so much decayed as to require renewal, which was done with larch; that 18 years after this repair, the sloop went to pieces on the remains of the pier of Methel, Fifeshire, and the top timbers and second foot-hooks of larch were washed ashore as tough and sound as when first put into the vessel, not one spot of decay appearing. The owner of a larch brig, who had employed her for several years on tropical voyages, also assures us that the timber will wear well in any climate, and adds that he would prefer larch to any other kind of wood, especially for small vessels; he also states that the deck of this brig, composed of larch planks, stood the tropical heat well, and that it did not warp or shrink, as was apprehended.

"Larch knees are possessed of such strength and durability, and are of such adaptation by their figure and toughness, that, were a sufficient quantity in the market, and their qualities generally known, we believe that none else would be used for vessels of any description of timber, even for our war navy of oak. The knees of vessels have a number of strong bolts, generally of iron, passing through them to secure the beam-ends to the sides of the ship. Larch knees are the more suited for this, as they do not split in the driving of the bolts, and contain a resinous gum, which prevents the oxidation of the iron.

"In all places where larch has become known, it has completely superseded other timber for clinker-built boats, surpassing all others in strength, lightness, and durability. For this purpose, young trees of about 9 in. in diameter, in root-cuts from 10 ft. to 20 ft. in length (for as you ascend the tree, the timber deteriorates greatly), with a gentle bend at one end, such as the larch often receives from the south-west wind, are the most suitable. The log should be kept in the bark till used; and, in dry weather, the boards put upon the boat's side within two or three days from being sawn out, as no timber we are acquainted with parts sooner with its moisture than larch; and the boards do not work or bend pleasantly when dry. When dried, the thin larch board is at once strong, tough, durable, and extremely light.

"For *rural Purposes generally*, larch is incomparably the best adapted timber, especially for rails, fences, or out-door fabrics exposed to wind and weather. It is also getting into use for implements of husbandry, such as harrows, ploughs, and carts. We have seen a larch upright paling, the timber of which, with the exception of the large charred posts, had only been eight years in growing, standing a good fence, sixteen years old, decked out by moss and lichen in all the hoary garniture of time.

"In the Construction of Buildings, larch is valuable only for the grosser parts, as beams, lintels, joists, couples. For the finer boarded part, it is so much disposed to warp, and so difficult to be worked, as generally to preclude use. It is, however, asserted that, if larch be seasoned by standing two years with the bark stripped from the bole before being cut down, the timber becomes manageable for the finer house-work."

The Durability of the Larch, when alternately exposed to Water and Air, was proved by an experiment made in the river Thames, at the suggestion of the Duke of Athol. "Posts," Sir Thomas Dick Lauder observes, "of equal thickness and strength, some of larch and others of oak, were driven down facing the river wall, where they were alternately covered with water by the flow of the tide, and left dry by its fall. This species of alternation is the most trying of all circumstances for the endurance of timber; and, accordingly, the oaken posts decayed, and were twice renewed, in the course of a very few years; whilst those which were made of larch remained altogether unchanged. "We had ourselves," says Sir Thomas Dick Lauder, "occasion to erect a foot-bridge to a pleasure walk over a sunk road, and this we ordered to be constructed of two long stretching beams, covered transversely with larch planks. In 14 or 15 years afterwards, we discovered symptoms of decay in the bridge, and ordered the carpenter to new plank it; but, when he came to carry our directions into execution, he discovered that the whole planks were quite sound, with the exception of three; and that these three, which were rotten almost to powder, were Scotch fir planks, which had been taken in a hurry, at the time the bridge was built, to supply a deficiency in the original number of the larch planks." (*Laud. Gilp.*, i. p. 154.)

In Mill-work, and especially for mill axles, where oak only used formerly to be employed, larch has been substituted by the Duke of Athol, in 1806, with the best effect. In the winter of that year, in cutting up an old decayed mill wheel, His Grace found those parts of the water cogs which had been repaired with larch in 1786, though black on the surface, on the hatchet being applied, as sound and fresh as when put up.

In Railroads, it is found to form excellent sleepers, and so great was the demand for it in 1836 and 1837, for this purpose, that it could scarcely be supplied even with the extensive plantations in Scotland.

As Hop Poles and Stakes for Plants, no wood whatever equals the larch. For these purposes, it ought to be planted close, so as to be drawn up with trunks of the requisite degree of slenderness; for, when planted thin, the stems are apt to become disproportionately thick below, as Cobbett describes to be the case with the sweet chestnut. (See p. 1996.) We have seen the larch, at 3 ft. apart, drawn up to the height of between 40 ft. and 50 ft., with clear straight stems, admirably adapted for hop-poles, and for poles for ornamental purposes in gardens; such as staking roses, forming arches and rustic work for training creepers, espaliers for fruit trees, &c. Even the young trees, which have been allowed to attain the height of 4 ft. or 5 ft. in nursery lines, make excellent props for the more delicate plants; and, when used with the bark on, will last, for an indefinite period.

As Guards for single Trees and small Groups, the larch possesses the advantages of strength to resist the rubbing of cattle; of durability at the surface of the ground, where it is alternately wet and dry; and of economy, because, when the bark is kept on, the expense of painting or Kyanising is unnecessary.

As live and as dead Fences, the larch possesses peculiar properties, bearing the shears apparently as well as the spruce. (See p. 2306.) Sir Thomas Dick Lauder once saw a very pretty larch fence in a gentleman's pleasure-ground near Loch Lomond. "The trees were planted at equal distances from each other; and, being clipped, were half cut through towards the top, and bent down over each other. In many instances, the top shoot of the one had insinuated itself into that adjacent to it, so as to have become corporally united to it; and, strange as it may seem, we actually found one top that had so inserted itself, which, having been rather deeply cut originally by

the hedge bill, had actually detached itself from the parent stock, and was now growing grafted on the other, with the lower part of it pointing upwards into the air!" (*Laud. Gisp.*, i. p. 157.)

A Larch Hedge, which immediately became a Fence, was formed, in the spring of 1831, to enclose a four-acre field of high, dry, and rather poor land, in the following manner:— A ditch was dug, 4 ft. wide, in the direction of the fence; and Mr. Gorrie having some plantations of larches, of nine years' standing, on an adjacent eminence, which required thinning, it occurred to him that it might be possible to construct of them a live fence that would have immediate effect; and, with this view, he had them taken up carefully, as marked out for thinning, about the beginning of March. He employed two other men in planting them among the earth thrown out of the 4-ft. ditch; he holding the tree, and giving it the intended position. It occurred to Mr. Gorrie that wind-waving was one principal preventive of the growth of larches transplanted at that age, which would be avoided by laying the trees in a slanting direction; besides, fewer trees would form an efficient fence, than if standing perpendicularly. "The trees were from 10 ft. to 12 ft. long, and were laid at about an angle of 30° with the horizon, the tops inclining a little over the ditch to the interior of the field, whence the danger from cattle attempting to break through was to be apprehended; the surface of the ditch bank being about from 1 ft. 8 in. to 2 ft. above the ordinary level of the ground, and the upper part of the roots about 3 in. below that surface, when the earth was dressed off. The plants were well feathered to the bottom with side branches, which were all allowed to remain on the trees; and at the surface the roots were from 2 ft. 6 in. to 3 ft. distant, but the stems, or centres, of the trees, from the sloping direction given them, were only from 1 ft. 3 in. to 1 ft. 6 in. distant, centre from centre, which, with the branches, presented an obstruction apparently more formidable than really so; and which had the effect of preventing any of the enclosed horses or cattle from making an attempt at taking a leap. The expense of digging the ditch and planting did not exceed 1s. per Scotch fall (18 ft. 6 in.); and thus an effective live fence was put up, at less than would have erected a 3-railed paling, the decay of which would commence the day on which it was erected; while the living larches, that otherwise would have been almost useless, will acquire yearly strength, which will soon present an insurmountable barrier to the passage of live stock; besides affording immediate shelter, which will be annually increasing. This year I find (as was to be expected) the leading shoot begins to assume a perpendicular direction; and every fourth or fifth tree, I intend to allow to grow to full maturity, when the proprietor of future times may find it convenient to have them cut up for naval timber. I did not expect that every plant transplanted at that age should grow; and the dry weather which followed in the summer of 1831 was by no means favourable to their success: about 80 plants died of 760. These I, this spring, interlined with young plants of about 3 ft. in length, transplanted larches from the nursery, inserted under the back-gone plant, the dead branches of which gave the young plant, with a little assistance, the proper direction. In order to make assurance doubly sure, I planted a row of young transplanted larches from the nursery at about 1 ft. apart, and 1 ft. separate from the old plants, to which they had a contrary direction given them. Here I should have taken blame to myself, if I had to record the death of a single plant. The whole are now in a thriving condition; and I can, with some degree of confidence, recommend the process to those who may have upland fences to form, and thinnings of larches of 9 or 10 years' standing to spare.— *Arch. Gorrie. Annal Gardens, Oct. 1. 1832.*" Mr. Gorrie informs us (December, 1837) that these larches have thriven amazingly, and that the trees placed in a slanting position now form most beautiful curves.

Dead Fences of larch branches, wattled between large stakes, have been tried in different parts of Scotland, and found to last many years. Young larch trees have also been planted (after being killed by being left several months out of the soil) in the form of a hedge, for shelter in a garden; and found to

have the advantage of producing shelter and shade without exhausting the soil by their roots, as in the case of live hedges.

The Bark of the Larch has long been used for tanning in its native Country (see p. 2365.), and it seems first to have been employed for that purpose in Britain, by Thomas White, Esq., of the Woodlands, near Durham, about the beginning of the present century. (See *Gen. Rep. of Scotland*, vol. iv. p. 501.) According to Monteath, when the best oak bark is 12*l.* 12*s.* per ton, the best larch bark is 5*l.* 5*s.* In general, he considers the bark of the larch to be equal to that of the birch; which, as it is well known, is generally used for the purposes of tanning in Sweden and Russia.

As a Nurse Tree, we have already mentioned, when treating of the spruce (p. 2305.), that the larch can be by no means recommended. By its vigorous growth, it robs the soil of what ought to nourish the trees to be protected; and, by its long, flexible, spiny shoots, it not only overtops them, but lashes and injures the leading shoots of the young trees.

Mr. Gorrie tells us, however, that "an exception may be taken in favour of the larch, as a nurse to the oak, the roots of which descend below the range of those of the larch. Its openness accords with the hardy nature of the oak in winter, and thus allows the tree to acquire protecting properties, before the nurses are removed. I have always found the oak to thrive, and acquire vigour, when nursed by larches. Of course, lashing and overtopping must be prevented, but this is easily done."

The Improvement of the Soil in which the Larch grows is one of those important results first discovered by the Duke of Athol, and is thus described:—"The lower and stronger branches meet together in six or seven years after planting, so as to form a complete matting over the ground. The air and light being excluded by them, all plants that are under them die. At the same time, the annual deposit of leaves from them, by means of decomposition, forms, in the course of time, a soil of considerable depth. At the age of 24, the larches lose the spines on the lower branches altogether, and that is the natural mark of their being ready to be removed by thinning, to a considerable extent. On the air being readmitted by the removal of the trees, the surface of the new-made soil wherever it has been formed, even among the rocks, becomes immediately covered with natural grasses, among which the *Hólcus móllis* and *H. lanátus* seem to predominate. These grasses continue to grow, and to thicken into a sward, by the annual top-dressing which they receive from a continued deposition of leaves. The improvement of the natural surface of the ground for pasturage, by means of the larch, appears to be a property peculiar to this tree. This pasturage is quite capable of improving the condition of cattle either in winter or summer." (*Highl. Soc. Trans.*, vol. xi. p. 188.) The grasses here mentioned, Mr. Gorrie observes, "are bad pasture grasses, and should be discouraged; but, as already observed (p. 2363.), finer grasses will grow under these trees."

As an ornamental Tree, the larch is generally considered to produce a very good effect, particularly in hilly scenery. It is admired, says Baudrillart, "for its pyramidal shape and spiry head; for the tender green, and peculiar disposition of its foliage; and for its female catkins, which spread over the tree, and, seen at a little distance, resemble wood strawberries in their form, colour, and size; contrasting strongly with the pale green of the beautiful tufts of leaves with which the branches are uniformly furnished. Placed singly on a lawn, or rising from a group of other trees, this species is rarely surpassed in beauty." The opinions of some English writers of acknowledged taste are, however, very different from this. Gilpin says: "The larch we have in England, compared with the larch of the Alps, is a diminutive plant. It is little more than the puny inhabitant of a garden, or the embellishment of some trifling artificial scene. The characters of grand and noble seldom belong to it. It is, however, an elegant tree; though, in our soil at least, it is too formal in its growth. Among its native steeps, its form, no doubt, is fully picturesque, when the storms of many a century have shattered its

equal sides, and given contrast and variety to its boughs." (*For. Scen.*) Wordsworth, in his *Description of the Scenery of the Lakes*, says: "It must be acknowledged that the larch, till it has outgrown the size of a shrub, shows, when looked at singly, some elegance in form and appearance; especially in spring, decorated as it then is by the pink tassels of its blossoms: but, as a tree, it is less than any other pleasing. Its branches (for boughs it has none) have no variety in the youth of the tree, and little dignity even when it attains its full growth. Leaves it cannot be said to have; and, consequently, it affords neither shade nor shelter. In spring, the larch becomes green long before the native trees; and its green is so peculiar and vivid, that, finding nothing to harmonise with it, wherever it comes forth a disagreeable speck is produced. In summer, when all other trees are in their pride, it is of a dingy lifeless hue; in autumn, of a spiritless unvaried yellow; and, in winter, it is still more lamentably distinguished from every other deciduous tree of the forest; for they seem only to sleep, but the larch appears absolutely dead." (*Description, &c.*, p. 93.) There is great truth in Wordsworth's description. The circumstance of the tree having no boughs, but only branches, doubtless detracts from its contrast and variety of form as a picturesque object; but the smallness of these branches, by never absorbing the wood of the trunk, renders it peculiarly valuable as a timber tree. Its chief beauty, therefore, consists in its powerful unity of expression as a timber tree. When its leading shoot is broken, and one or more of the side branches take the character of boughs, (as in the Dalwick tree, fig. 2261. p. 2356.; a tree at Knowle, in Kent; and some others that might be mentioned;) it then becomes as varied and picturesque as Gilpin or Wordsworth could desire. Its death-like character during winter is very remarkable, and almost peculiar to the tree. The *Gymnócladus canadensis*, or stump tree of the French (see p. 656.), conveys the same death-like expression, but by a totally different form. After all, the larch can only be seen in its characteristic beauty on the steep sides of the mountains of Switzerland; or, projecting from the rocky precipices of the Tyrol. (See fig. 2263. in p. 2357.) It will, doubtless, have something of the same expression on the mountains of the Highlands of Scotland; but there its picturesque effect must be greatly diminished, from the uniformity with which the surface is covered, and the trees being comparatively equidistant, and all of the same age and size. At least, this was the case in the neighbourhood of Dunkeld, the last time we were in that romantic country, in 1806. "To produce an ornamental larch, it should be carefully nursed, removing the nurses gradually, to allow air enough to encourage the lower branches, but affording shelter enough to produce length of stem. I do not know a more beautiful object on a lawn in the early summer months, though not picturesque, than a tree so treated, forming a delicate pea-green cone, from the grass to the height of 50 ft. or 60 ft. If properly managed, the lowest branches will live as long as the tree." We fully acknowledge the justice of this remark, and have felt it ourselves, when seeing even the young larches in the Horticultural Society's Garden, and some of the fine old specimens at Syon, Whitton, and Pain's Hill, the lower branches of which sweep the ground.

Soil and Situation. The larch will grow rapidly upon almost any soil, and in any situation, for the first 20 or 30 years; but it is only in a clear dry atmosphere, on a cold-bottomed soil, somewhat moist on the surface, that its timber is brought to perfection. In plains, and near the sea, it grows rapidly for 30 or 35 years; but, when felled in such situations, the wood is found rotten at the heart, and unfit for any purpose except fuel. This decay of the wood is much aggravated, when the larches are planted thick, so as to expose but a small portion of their foliage to the sun, and to retain among their lower branches an atmosphere surcharged with moisture. The larch will grow, and become valuable timber, at a much greater elevation above the sea than the Scotch pine, thriving at the height of 1800 ft. in the Highlands, where the Scotch pine does not attain a timber size at a greater elevation

than 900 ft. In Switzerland, Kasthoffer informs us, it is found in the highest perfection in soil composed of the debris of calcareous rocks, as well as in granitic, argillaceous, and schistose soils.

The following admirable remarks by Professor De Candolle show the necessity of a clear and dry atmosphere, and a soil somewhat moist on the surface, to the prosperity of the larch as a timber tree:—"Amongst all the general circumstances which have an effect on vegetation, that which appears to me most necessary to the larch is, that it have at the same time its roots in a soil habitually, but moderately, damp, and its top exposed to the direct rays of the sun, so that the evaporation of water, and the decomposition of carbonic acid, may go on with activity. I support this opinion, 1st, on general observation of the places where I see the larch prospering; 2dly, on theory. The larch has fine and minute leaves, and, of all trees which shed their leaves, it must present a less surface; consequently, the action of these surfaces must be greater to produce the same results. Larches generally thrive on the declivities of our mountains, seldom on flat places; because on declivities there is always a little dampness in the earth, descending from the surface above; and, at the same time, the trees, on account of the inequality of their bases, have more space at their tops, and are better exposed to the light; whereas flat places are often too dry, and the trees, being all of the same height, overshadow each other. Among declivities, those which are connected with summits covered with perpetual snow are those where larches grow best; because there they are slightly and continually watered by the gradual melting of the snow during summer, and, at the same time, their heads are well exposed to the sun. Declivities, and, in general, elevated countries, suit larches best; because the action of the light is more intense there than in low countries: yet the larch succeeds well enough in situations only a little elevated above the level of the sea, provided the atmosphere be not obscured by fogs and constant cloudiness. If the larch seems to like to have its roots in a soil moderately damp, it likes also to avoid the dampness of the atmosphere. On that account, it grows badly near lakes, rivers, cascades, and under the shade of rocks, even in those countries where, in other situations, it would flourish. We are here (Geneva) very near the countries where the larch grows beautifully. We are at a height superior to that where we know of fine larches existing; yet it does not thrive in our valley, particularly near the lake and the river. The constant dryness of the air of the Alps is also one of the causes which makes it prosper there. The dampness of the air tends to diminish the evaporation of the leaves, which is so necessary to the health and vigour of the tree. It has been remarked that the larch does not grow well near the sea, which proves what I have just advanced. The sea produces an increase of dampness in the air in two ways: 1st, like the surface of fresh water, it exhales much moisture into the atmosphere; 2dly, the watery particles which are thrown out by the waves are carried here and there, and deposited on all solid bodies; and, when the moisture they contain evaporates, it leaves behind a certain quantity of salt, more or less deliquescent (muriates of lime and soda), which constantly attracts dampness.

"In Switzerland, the larch grows better in those parts exposed to the north than to the south. The difference is sometimes so striking, that in the valleys parallel to the equator, it is not rare to see all the side to the north covered with larches, and none at all to the south. I am inclined to believe that this arises from the irregularity of our spring, which causes the buds of the larches to be too precocious on the southern declivities; and, consequently, they are frequently killed by the frost. In the latitude of Great Britain, where the spring is more regular, I think this cause will not operate; and I should say that, if the southern declivities be not too dry, the larches will succeed better there than here." (*Quart. Journ. of Agr.*, vol. v. p. 409.)

Sang mentions it as a fact ascertained by experience, that the larch thrives best in inland and elevated situations. It will not, he says, "grow up to perfection, even in the best soils, and in situations most favourable to trees in

general, if these be low ; and, where oak, chestnut, elm, and ash have produced wood perfectly sound, the larches in the same soil and situation have had their trunks quite hollow a good way upwards." (*Plant. Kal.*, p. 93.) At Raith, at Leslie, and at other places in Fifeshire, the larch had, in 1812, attained a great size on rich banks and in warm situations ; but, in nearly 1000 trees which were cut down at that time, there was scarcely one in which the trunk was not beginning to decay at the heart. (*Ibid.*, p. 59.) The fitness of soil for larch, Matthew observes, "seems to depend chiefly upon the ability the soil possesses of affording an equable supply of moisture ; that is, upon its mechanical division, or on its powers of absorption or retention of moisture ; and its chemical composition would seem only efficacious as conducive to this." Throughout Scotland, he says, wherever he has observed the decay of larch wood, it has resulted almost solely from unsuitableness of soil. "We have witnessed," he continues, "the tree as much diseased on our highest trap hills, 1000 ft. in altitude, as on a similar soil at their base." (*Ibid.*, p. 78.) "The larch," Sir W. Jardine observes, "is very soon lost when planted above a substratum of red sandstone. In the vale of the Annan, wherever the sloping banks have a substratum of this rock, or one composed of a sort of red sandstone, shingle, or gravel, the outward decay of the tree is visible at from 15 to 25 years of age. The internal decay commences sooner, according to the depth of the upper soil, in the centre of the trunk at the root, in the wood being of a darker colour, extending by degrees in circumference, and up the stem, until the lower part of it becomes entirely deprived of vegetation, and assumes a tough and corky appearance. This extends to the whole plant, which gradually decays and dies. On the same soil, the oak grows and thrives well." (*Sir W. Jardine*, in his notes to *White's Nat. Hist. of Selborne*.) Mr. Matthew divides soils and subsoils into two classes : the first, where larch will acquire a size of from 30 to 300 solid feet, and will generally be found free of rot ; the second, where it reaches only from 6 to 20 solid feet, and, in most cases, becomes tainted with rot before it is 80 years old. As this subject is of great importance to the planter of the larch, and as Mr. Matthew is an author whose science and practical knowledge may be relied on, we quote his observations on the subject at length :—

"CLASS I. *Soils and Subsoils proper for the Larch.*—1. *Sound Rock*, with a covering of firm loam, particularly when the rock is jagged or cleft, or much broken, and mixed with the earth. In such cases, a very slight covering or admixture of earth will suffice. We would give the preference to primitive rock, especially micaceous schist and mountain limestone. Larch seldom succeeds well on sandstone or on trap, except on steep slopes, where the rock is quite sound, and the soil firm. We have had no experience of larch, except very young, growing on chalk and its affinities. Primary strata are generally well adapted for larch, except where the surface has acquired a covering of peat moss, or received a flat diluvial bed of close wet till, or soft moorish sand, or occupies too elevated or exposed a situation ; the two latter exceptions only preventing the growth, not inducing rot.

"2. *Gravel*, not too ferruginous, and in which water does not stagnate in winter, even though nearly bare of vegetable mould, especially on steep slopes, and where the air is not too arid, is favourable to the growth of the larch. The tree seems to prefer the coarser gravel, though many of the stones exceed a solid yard in contents. The straths, or valleys, of our large rivers, in their passage through the alpine country, are generally occupied, for several hundred feet of perpendicular altitude up the slope, by gravel ; which covers the primitive strata to a considerable depth, especially in the eddies of the salient angles of the hill. Every description of tree grows more luxuriantly here than in any other situation in the country. The causes of this are : 1. the open bottom allowing the roots to penetrate deeply, without being injured by stagnant moisture ; 2. the percolation of water down through the gravel from the neighbouring hill ; 3. the dryness of the surface not producing cold by evaporation, and the ground, on this account, soon heating in spring ; 4. the moist

air of the hill refreshing and nourishing the plant during the summer heats, and compensating for the dryness of the soil; 5. the reverberating of the sun's rays between the sides of the narrow valley, thus rendering the soil comparatively warmer than the incumbent air, which is cooled by the oblique currents of the higher strata of air, occasioned by the unequal surface of the ground. This comparatively greater warmth of the ground, when aided by moisture, either in the soil or atmosphere, is greatly conducive to the luxuriance of vegetation.

"3. *Firm dry Clays, and sound brown Loam.* Soils well adapted for wheat and red clover, not too rich, and which will bear cattle in winter, are generally congenial to the larch.

"4. *All very rough Ground,* particularly ravines, where the soil is neither soft sand nor too wet; also the sides of the channels of rapid rivulets. The roots of most trees luxuriate in living or flowing water; and, where it is of salubrious quality, especially when containing a slight solution of lime, will throw themselves out a considerable distance under the stream. The reason why steep slopes and hills, whose strata are nearly perpendicular to the horizon, are so much affected by larch and other trees, is, because the moisture in such situations is in motion, and often continues dripping through the fissures throughout the whole summer. The most desirable situation for larch is where the roots will neither be drowned in stagnant water in winter, nor parched by drought in summer; and where the soil is free from any corrosive mineral or corrupting mouldiness. Larch, in suitable soil, 60 years planted, and seasonably thinned, will have produced double the value of what almost any other timber would have done in the same time and situation; and, from its general adaptation both for sea and land purposes, it will always command a ready sale." (*On Naval Timber*, p. 85.)

CLASS II. *Soils and Subsoils where Larch takes the Dry Rot.*—The same experienced and scientific author has enumerated the situations, soils, and subsoils in which the larch, if planted, though it will grow freely, is subject to the rot, or to other diseases.

1. *Situations (steep Slopes excepted) with cold Till Subsoil, nearly impervious to Water.* The larch succeeds worst when moorish dead sand, alone or with an admixture of peat, occupies the surface of these retentive bottoms. Where the whole soil and subsoil are one uniform, retentive, firm clay, the larch will often reach considerable size before being attacked by the rot. When this heavy clay occupies a steep slope, the larch will sometimes succeed well, owing to the more equable supply of moisture, and the water in the soil not stagnating, but gliding down the declivity. In general, soils the surface of which assumes the appearance of honeycomb in time of frost, owing to the great quantity of water imbibed by them, will not produce large sound larch.

"2. *Soft Sand Soil and Subsoil.* Sand is still less adapted for growing larch than clay, the plants being often destroyed by the summer's drought before they attain sufficient size for any useful purpose: the rot also attacks them earlier on sand than on the clay. It appears that light sand, sloping considerably on moist back-lying alpine situations, covered towards the south by steep hills, will sometimes produce sound larch; whereas, did the same sand occupy a dry front or lowland situation, the larch would not succeed in it. The same moist back situation that conduces to produce sound larch in light dry soils, may probably tend to promote rot in the wet. The moisture and the less evaporation of altitude may also, in some degree, diminish the tendency to rot in dry light sand, and increase it in wet clay. Larch will sometimes succeed well in sharp, dry, alluvial sand left by rivulets.

"3. *Soils incumbent on brittle dry Trap, or broken slaty Sandstone.* Although soil the debris of trap be generally much better adapted for the production of herbaceous vegetables than that of sandstone or freestone, yet larch does not seem to succeed much better on the former than on the latter. The deeper superior soils generally incumbent on the recent dark red sandstone,

are better suited for larch than the shallow inferior soils incumbent on the old grey and red sandstone.

"4. *Ground having a Subsoil of dry rotten Rock, and which sounds hollow to the Foot in Time of Drought.*

"5. *Rich Earth, or Vegetable Mould.* Independently of receiving ultimate contamination from the putrid juices or exhalations of this soil, the larch does not seem, even while remaining sound, to make so much comparative progress of growth in it as some of the hard-wooded trees, as elm, ash, and sycamore.

"6. *Black or grey moorish Soils, with Admixture of Peat Moss.* Although the soils specified in this class will not afford fine large larch for naval use, yet they may be very profitably employed in growing larch for farming purposes, or for coal-mines, where a slight taint of rot is of minor importance. The lightness of larch, especially when newly cut (about one third less weight than the evergreen *Coniferæ*), gives a facility to the loading and carriage, which enhances its value, independently of its greater strength and durability. Those larches in which rot has commenced are fully as suitable for paling as the sound: they have fewer circles of sap wood, and more of red or matured wood. When the rot has commenced, the maturing or reddening of the circles does not proceed regularly, reaching nearest the bark on the side where the rot has advanced farthest." (*Ibid.*, p. 88.)

Gathering the Cones and extracting the Seeds. The cones may be gathered any time during the winter season, and kept in a dry place till a week or two before the time of sowing, which generally takes place in April. Boucher found that, though the cones of the larch are at their full size in autumn, yet the greatest part of the seeds they contain are not then arrived near their maturity, and that they ripen hanging on the trees, during even the coldest winter months. He therefore defers gathering the cones till the month of March or April, when they easily part from the tree, and many of them drop from it. The seeds, when kept in the cones, will retain their vitality for four or five years; but, when taken out of them, they lose it in a few months. De Candolle attaches no great importance to the choice of seeds; though it cannot be denied, he says, that trees growing from seeds taken from diseased trees must be more liable to those same diseases. He cautions such as procure seeds from the Tyrol against a practice which he has heard prevails there, of placing the cones near a large fire to make them open; by which the seeds must be greatly injured, if not totally deprived of their vitality. The cones gathered in the Vallais, he says, are generally opened by the heat of the sun, or over a slow fire; and the seeds from that quarter are preferred by the cultivators of France and Germany. Cones ripened in Britain may either be dried on the kiln, without previous preparation, in the manner already directed for the *Abiétinæ* in general (see p. 2131.); or each cone may be split before putting it into the kiln, which is a safer method, and less likely to injure the seeds. The operation of splitting, Mr. Sang informs us, "is performed by a small, flat, triangular spatula, sharpened at the point and cutting-angles, and helved like a shoemaker's awl. The cone is held by the fore-finger and thumb of the one hand, upon a flat piece of wood; while with the other, by the splitter, it is split up from the thick end; and afterwards each half is split up the middle, which parts the cone into four divisions. This affords occupation, in wet or stormy weather in the winter season, for the workmen of a place, or for boys or girls, or old people; and is by far the best and least destructive to the seeds of any methods we know; because the cones so split, when exposed to the heat, are suddenly opened, and readily discharge the seeds; which, consequently, are less injured by the fire heat than they would be if the cones were longer exposed to it; which, if not split, they would require to be, to cause them to open." Besides the above method of splitting, there are others. "Some people," Sang continues, "use a cone mill, which has large sharp teeth in a concave cylinder, and others fixed in a corresponding roller. The mill is worked by turning the roller with a handle

resembling that of a common winnowing-machine. The cones are let into the mill through a hopper. This instrument is very difficult to work, and bruises the seeds very much, many of which are, of course, destroyed. We have several times made use of the improved bark mill, for separating the seeds from larch cones; but the cones are thus so much compressed and bruised, that the seeds suffer exceedingly; and we would by no means advise its use. Indeed, among all the methods which we have known adopted, to perform the painful and laborious work of extracting the seeds of the larch, the plan of splitting the cones singly, as above described, is infinitely the best and safest for the seeds, and ought to be adopted by every one who has occasion to use only small quantities of seed." (*Plant. Kal.*, p. 827.)

Nursery Culture. The seeds may be sown in April, on finely prepared soil, and so as to rise about the same thickness as the Scotch pine, that is, at about a quarter of an inch distant from each other. Mr. Sang recommends sowing the larch on ground from which a crop of two years old seedling Scotch pines has been removed. No preparation of the soil, he says, can equal that of the roots of seedling Scotch pines; and the next best preparation is a crop of two years' seedling larch. In either case, the seedlings are supposed to be removed in September, and the soil dug over several times between that month and the April following, so as to expose it thoroughly to the winter's frost. When the soil is manured, new dung from the stable or cow-house must be carefully avoided, as proving highly pernicious to the young plants; but old rotten dung may be used with advantage. After the seeds are sown, previously to covering them, a light roller should be drawn over the bed, to press the seeds firmly into the earth. The covering should be from $\frac{1}{4}$ in. to $\frac{1}{2}$ in. in thickness, according as the soil is sandy or loamy. The plants may remain two years in the seed-bed, and afterwards be planted out into nursery lines, or in plantations where they are finally to remain. The season for transplanting is the autumn, or very early in spring, because the larch vegetates earlier than most other trees, and suffers more than any other when removed after it has begun to grow.

Culture in Plantations. In general, very little preparation of the soil, except draining, is required for a larch plantation; partly, because the larch is generally planted on declivities, the soil of which, if loosened by digging or trenching, would be washed away by rains; and partly because such declivities are generally so rocky, or covered with large stones, as to render digging or trenching impracticable. In all the extensive plantations of the larch made in Scotland, two years' seedlings, or strong one year's seedlings, one year transplanted, are made use of; and the mode of planting adopted is the slit manner, already recommended for the Scotch pine. (See p. 2179.) The larch, where the object is clean straight timber, should be planted in masses by itself, at the rate of from 3000 to 4000 plants to the acre; to be thinned out to 400 or 500 trees per acre, which is supposed to be the number that that portion of surface will bring to perfection. The larch is also very commonly introduced in mixed plantations, to be thinned out as these advance to maturity; young larches being more valuable for country purposes than any other young tree whatever. From what has been already said on the influence which soil and situation have on the wood of the larch (see p. 2376.), the propriety or impropriety of allowing larches in mixed plantations, or, indeed, in any other, to attain their full size, may be determined. In general, there are few situations, in the plains either of England or Scotland, where full-grown larches will be found sound at the heart; but, at the same time, perhaps none where any tree will prove so valuable as the larch, when it is to be cut down just as the rot is beginning to appear. The larch is also sometimes planted as a nurse; though for this purpose it is found far inferior to the Scotch pine and the spruce fir, as already mentioned (p. 2305.). It has, however, the advantage of being more valuable than the Scotch pine when cut down. The great value of the larch is as a mountain tree; and on

immediately under the line formed by the circumference of the branches of the centre tree. As the larches advance in growth upwards, the branches of the elm or other tree will extend horizontally, and force the former to take a bent position outwards. To us, it appears that this is too servile an imitation of nature, and that a more effective mode would be, to bend down the trees as recommended by Mr. Matthew, or to cut them over, and treat them in such a manner as to encourage a lateral branch to become the leader, as shown in the portrait of the Great Larch at Dalwick (fig. 2261. p. 2356.) Another method, which has been recommended by South and Matthew, where it is wished to grow crooked timber, is, to undermine the trees, so as to throw them over to one side, when they have attained a certain height, say from 10 ft. to 20 ft. or 30 ft.; and leave them in that position to recover the perpendicularity of their leading shoots, by their annual growths.

Probing the Roots of the common Larch, and laying bare those fitted for Knees for Ship-building. Mr. Matthew finds, from experience, that the roots of larch form the best of all knees; and that they might be much improved by culture, though the practice does not seem to have been attempted or thought of. The following are his very ingenious, original, and rational directions, for attaining this object; and we would strongly recommend them to the attention of all possessors of larch plantations, where the timber is likely to become fit for ship-building:—"To form the roots of the larch properly into knees, should the plants be pretty large, the planter ought to select those plants which have four main roots springing out nearly at right angles, the regularity of which he may improve a little by pruning; and he should plant them out as standards in the thinnest driest soil suited for larch, carefully spreading the roots to equal distances, and in a horizontal position. To promote the regular square diverging of these four roots, he should dig narrow gutters, about 1 ft. deep and 3 ft. long, out from the point of each root, and fill them in with the richest of the neighbouring turf, along with a little manure. When the plants are small, and the roots only a tuft of fibres, he should dig two narrow gutters about 8 ft. long, crossing each other at the middle at right angles, fill these as above, and put in the plant at the crossing: the rich mould of the rotted turf, and its softness from being chopped, will cause the plant to throw out its roots in the form of a cross along the trenches. When the plants have reached 5 ft. or 6 ft. in height, the earth may be removed a little from the root; and, if more than one stout root leader have run out into any of the four trenches, or if any have entered the unstirred earth, they ought all to be cut except one, the stoutest and most regular in each trench. In a few years afterwards, when the plants have acquired some strength, the earth should be removed gradually, baring the roots to from 2 ft. to 5 ft. distance from the stool, or as far as the main spurs have kept straight; and cutting off any side shoots within the distance, should it be found that such late root-pruning does not induce rot. This process of baring the roots will scarcely injure the growth of the trees, as the roots draw the necessary pabulum from a considerable distance; nor, if done carefully, will it endanger their up-setting; and the roots, from exposure to the air, and freedom from the pressure of the soil, will swell to an extraordinary size, so as to render them, ere long, the firmest-rooted trees in the wood. The labour of this not amounting to the value of sixpence each tree, will be counterbalanced thrice over by the ease of grubbing the roots for knees; and the whole brought to the shipwright will produce more than double the price that the straight tree alone would have done." On this passage, Mr. Gorrie observes, that "cutting the roots of a growing larch is dangerous, and will inevitably produce rot." Mr. Matthew continues:—

"The forester should also examine and probe the roots of his growing larch, even those of considerable size, in sound ground; and, when several strong horizontal spurs, not exceeding four, are discovered nearly straight, and from 2 ft. to 5 ft. long, he ought to bare the roots to that distance, that they may swell, carefully pruning away any small side roots, and reserve these plants as valuable store,

taking good heed that no cart-wheel, in passing, or feet of large quadruped, wound the bared roots. In exposed situations, the earth may be gradually removed from the roots.

"The rot in larch taking place in the part appropriate to knees, the forester cannot be too wary in selecting the situations where there is no risk of its attack, for planting those destined for this purpose. It is also desirable, if possible, to have the knee timber in ground free of stones or gravel, as the grubbing in stony ground is expensive, and the roots often embrace stones which, by the future swelling of the bulb, are completely embedded and shut up in the wood, particularly in those places between the spurs where the saw section has to divide them for knees. Were the roots carefully bared at an early period, it would tend to prevent the gravel from becoming embedded in the bulb. Nothing can be more annoying to the shipwright, when he has bestowed his money, ingenuity, and labour, upon an unwieldy root, and brought his knees into figure at the cost of the destruction of his tools by the enveloped gravel, to discover stains of incipient rot, which render the intended knee mere lumber.

"As the larch, unlike the oak, affords few or no crooks naturally, excepting knees, the artificial formation of larch crooks is of the utmost consequence to the interest of the holders of larch plantations now growing. In order to obtain a good market for their straight timber, it is absolutely necessary to have a supply of crooks ready as soon as possible to work the straight up. This would increase the demand, and then enhance the price of the straight more than any one not belonging to the craft could believe. In good soil many of the crooks would be of sufficient size in 20 years to begin the supply, if properly thinned out. In a forest of larch, containing many thousand loads, and which had been untouched by any builder, we have seen the greatest difficulty in procuring crooks for one small brig. It is only on very steep ground, and where the tree has been a little upset after planting, that any good crooks are found. From the rather greater diameter required of larch timbers, and also from the nature of the fibre of the wood, we should suppose that steam-bending of larch timbers would scarcely be followed, even as a *dernier ressort*."

Felling. The larch is a remarkably easy tree to fell, from having no large boughs to interfere with the adjoining trees. The best season for performing the operation is winter, and the trunk may either be severed from the root, or otherwise, according to the object in view. If the ground among the remaining trees is to be kept as grass, root-felling is obviously to be preferred; as will generally be the case when the roots are of any value as fuel. In order to season the wood of the larch, as we have already seen, p. 2365., Mr. Monteath recommends barking the trees standing, and leaving them in that state for one, or even two, summers, before they are cut down. A number of larch trees on Dunnpace estate, in Stirlingshire, were barked by Mr. Monteath, and stood in the peeled state two summers, before they were cut up, and the wood made into paneled doors; which stood perfectly without warping or twisting. He has since frequently himself used, and seen used by others, the timber of larch trees, after having stood twelve months with the bark taken off, then cut down, and immediately cut up into battens for flooring; and also made into paneled doors and window frames, for the better sort of houses, with equal success. (*Forest Guide*, ed. 2., p. 240.) It has been remarked, that the roots of the larch, when left in the ground, decay much sooner than those of the Scotch pine; the former being liable to the attacks of an insect which does not prey upon the latter.

Accidents, &c. From the larch having only small branches, and from its leaves being deciduous, it is liable to few accidents, either from wind or snow. A fall of snow, the Duke of Athol observes, "will destroy in one night, and break and tear down, sometimes more than one third of a Scotch pine plantation, at all ages. High winds also destroy pines in numbers; but the

larch is never broken by snow; and very seldom torn up by winds, and then only in single trees." (*Gen. Rep.*, &c., vol. iv. p. 500.)

Diseases. The larch De Candolle considers as the alpine tree which is less liable to disease than any other. "There is," he says, "a peculiarity which all persons accustomed to observe these trees have been struck with; namely, that the trunks are remarkably healthy. They are, in particular, rarely attacked by the *Dermestes* (*Hylurgus*), which is so formidable to pines. Sometimes, but very seldom, we see a small caterpillar devouring the leaves, but no damage results from it. M. De Charpentier has even seen, in the Vallais, in July, 1820, all the trees, from the Valley of Conches to the bottom of that of Ferset, bereft of their leaves through the same cause; but none of these trees perished. Sometimes, also, we see the larches having a wound of resinous cancer; but this seems to proceed from some accidental cause, such as a blow or knock, which the tree may have received when it *was in full sap*. All these observations incline me to think that the cause of the diseases which attack the British larches," De Candolle continues, "must be sought for in some difference existing in the physical nature or in the culture of your trees and ours. The want of a sufficiently intense light, owing to the obliquity of the solar rays, and to the opacity of the atmosphere, and the over damp state of the latter, appear to me permanent causes which, in your climate, must predispose the larches to a state of watery plethora, which is probably the cause of the destruction remarked in the heart of the wood. This cause has little or no effect during the *youth* of the tree, because then its vegetation is vigorous; but it goes on increasing until the tree arrives at the age when, in all trees, vegetation begins to be feeble."

The Larch Blight (Coccus lárícis). This insect, according to Sang, was first observed by him on the larch, at Raith, in Fifeshire, about 1785; but did not appear to have done any great injury to the trees. The Duke of Athol saw it first on his trees in 1795, many of which, growing in low situations, it destroyed; which was also the case, the Duke of Portland informs us (*Quart. Journ. of Agri.*, vol. iv. p. 548.), in low damp situations in the neighbourhood of Wellbeck, in Nottinghamshire. The season at which it was most prevalent, the frosts were very severe, late in the spring, and the clouds of frost-fog, which rested on the larch on calm mornings, when the trees were just coming into leaf, were supposed by the duke to have "produced the blight." His Grace did not find trees above 25 ft. or 30 ft. in height affected by it; neither did it appear at all on the high grounds, where a slight breeze of air could shake the trees. (*Gen. Rep.*, iv. p. 500.) According to Mr. Webster (40 years gardener at Munches), the trees affected with this blight appear to have their foliage covered over with a whitish substance, which adheres to the fingers when touched, and consists of small globules. When the trees infested shed their leaves, they appear covered with blackish stains, both on the trunk and branches, and especially on the side most washed by the rains; and this blackness is so conspicuous, that Mr. Webster says he could always point out, in winter, the trees that had had their leaves infested the preceding summer. (See *Quar. Jour. Agri.*, vol. v. p. 536.) Pontey judiciously observes that the insect is always most abundant upon trees which have been previously in an unhealthy state; and that, in elevated situations, it is comparatively rare. Both he and Sang agree that the multiplication of the insect depends greatly on the languor or vigour of the tree; and, as these are much affected by the seasons, two or three fine summers and severe winters, in succession, generally so reduce the numbers of the insect, as to render the injuries it commits of no account. These insects appear to have been most abundant from 1802 to 1806; but have since gradually disappeared; and, from 1815 to 1837, have scarcely been noticed as injurious by planters. The coccus, however, is an insect which is found on various trees, indigenous and exotic; and, as it can never be wholly eradicated from the country, it may be expected to make occasional reappearances. In the Duke of Devonshire's plantations, made in 1816, at Low Plains, near Penrith, the roots of the larch, wherever it was

planted upon dry soil, were attacked by a small insect, resembling the wire-worm, from $\frac{1}{2}$ in. to $\frac{3}{4}$ in. in length. From 10 to 20 worms, and sometimes more, have been observed at the root of one tree. (*Trans. Soc. Arts*, vol. xxxviii. p. 6.)

Fúngi. The European larch, and also the Russian variety, when old, or when the trunk is beginning to decay, will produce the *Bolëtus lárícis*, which is called by some authors *Agáricus púngens*, and which is used in Russia, and some other parts of the north of Europe, as an emetic in intermittent fevers. It is also the agaric of the larch of the shops. The body of this fungus is saponaceous; and, Pallas informs us, is used by the women in some parts of Siberia to wash themselves and their linen. The Tungouses dye the hair of their reindeer with it and the roots of *Gálíum vèrum*, of a deep red colour. For other *Fúngi* growing on the larch, see the general article on the *Fúngi* of the *Abiétinæ*, p. 2146.

The Rot in Larch Wood is a disease which has hitherto baffled every attempt of physiologists and planters to ascertain its cause. It seems to have been first observed about the beginning of the present century, when some larch trees growing in fertile soils were cut down and sawn up for use. We are not aware of any record of the disease earlier than that given in our *Treatise on Country Residences*, published in 1806. In Sang's *Planter's Kalendar*, the first edition of which was published in 1812, several instances are given of the rot having appeared in Fifeshire, apparently from the trees having been planted in too rich a soil, and too warm a situation. Pontey does not notice the rot in larch, though he does that of timber trees in general; but Matthew treats of it at some length. In the *Gardener's Magazine*, the subject is discussed by Mr. Gorrie and Mr. Munro; and there are several articles on the subject in the *Quarterly Journal of Agriculture*; one of which, written in answer to certain questions put by the editor of that journal to Professor De Candolle of Geneva, we have already quoted from. From all these sources, and some other incidental ones, we are only able to give the following unsatisfactory account:—

The rot attacks trees at various ages, and in different soils and situations. There are instances, in Scotland, of larch trees of 8 or 10 years' growth having the interior of their stems tainted with the rot; but, in general, both in England and Scotland, it does not attack the trees till they are from 20 to 30 years of age. It generally commences at the root, and proceeds upwards, rotting the heart of the trunk; but, in some instances, it has been found to commence at the top of the tree, and proceed downwards. In a majority of cases, Matthew observes, the rot commences in the roots which have struck down deepest into the earth; especially those immediately under the trunk of the tree. Thence, the corruption proceeds upwards in the centre of the trunk; which, when much diseased, swells considerably for a few feet above the ground; evidently, Mr. Matthew observes, from the new layers of sap wood forming thicker there, to afford necessary space for the fluid to pass upwards and downwards; the matured wood, through which there is no circulation, approaching, at the lower part of the trunk, to within one or two annual layers of the bark. The disease can scarcely be detected by the external appearance of the tree; but, when it is cut down, the interior of the trunk is found brown and rotten to a greater or less extent; and, in trees which have been subject to the disease for some years, the centre is so entirely rotten as to have become hollow, like a pipe or wooden pump; and hence, as before observed, the name of pumping has been applied to this disease. Sections of trees, of different ages and sizes, affected in this manner, have been sent to us by Mr. Gorrie and Mr. Munro. (See *Gard. Mag.*, vol. ix. p. 551.; and vol. x. p. 554.) *Fig. 2266. a* shows a section of a larger-sized tree, in which the pumping has only just commenced, though the rot has extended itself so as to discolour the whole of the heart wood; and *fig. 2266. b* a section of a young tree in which pumping has begun early, and extended very considerably, in proportion to the diameter of the trunk. In some soils, the rot commences as

early as seven or eight years after planting, and in all it seems to proceed with the greatest rapidity; sometimes destroying the trees entirely, between 15 and 25 years old, on soils in which the oak prospers. (See p. 2376.) With regard to the cause of this

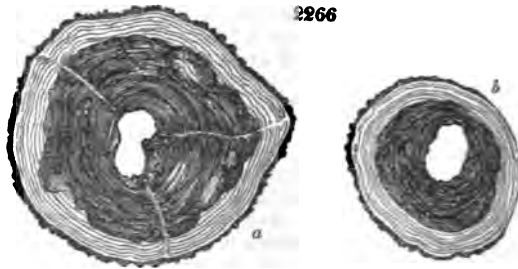

disease, it is by most planters attributed to the soil and situation; and by some to improper management. The latter seems to be supposed to consist chiefly in improper pruning, that is, cutting off part of its roots in the process of planting, or depriving the tree of part of its branches in the early stages of its growth. The rot in the larch, Mr. Gorrie observes, "has been found to prevail on rich deep soils, and in poor shallow soils, on retentive and porous subsoils, on soils incumbent on freestone, limestone, and whin, or green, stone; and, also, on all these descriptions of soil and subsoil, the larch has been found tolerably free from this hidden disease. This being the case, we are led to suppose that the rot in larch takes its rise from something accidental, rather than from any natural property in the soil. It has been a common practice to follow a crop of Scotch pine with this more lofty and promising plant; and the writer of this has recently discovered, in numerous instances, that, where this has taken place, the rot uniformly commences in fearfully numerous instances. This effect is produced as soon as 7 or 8 years after planting; while plantations of the same plant, on the same estate, planted at the same period, and in every respect similarly circumstanced to the other, with the important exception that they did not follow the Scotch pine, continue entirely free from the rot. In old plantations, too, where the Scotch pine and larch had been mixed together, and where the disease was by no means prevalent, the new crop of larch was completely affected; giving room to infer that the rotting roots of the *Pinus sylvestris*, or Scotch pine form, at least, one powerful agent in promoting this disease." (*Gard. Mag.*, vol. vii. p. 574.) In the *Quart. Jour. of Agri.*, vol. v., Mr. Gorrie repeats the above observations, and adds: "In this opinion I am supported by my esteemed friend, Mr. James Young of Pitfour, whose sound judgment and practical skill place him high in the estimation of his professional brethren." Mr. Gorrie then gives some extracts from a communication by Mr. Young, from which it appears that Mr. Young, when thinning out a plantation of young larches, (which had been planted as nurses to oaks, and had succeeded a crop of Scotch pines,) found the proportion of decaying plants about 6000 to 50; while larches in the neighbourhood, on similar soil, but not succeeding the Scotch pine, were found, when cut down at 60 years' growth, "to be of excellent quality, only one in six or eight showing slight symptoms of the disease." Mr. Young adds that he cannot bring himself to believe that there is anything deleterious in the soil naturally; but that he thinks it possible that the Scotch pine "roots, in the course of decay, after the trees have been cut down, may have communicated some poisonous quality to the soil, which promotes or originates this disease in the larch." Mr. Webster observes that the disease is most prevalent in plantations of the larch where the trees are planted so closely together as not to admit a free circulation of air. Mr. Munro thinks it probable that an extensive annual deposit of alumen, when the tree is young, is the cause of the rot. (*Gard. Mag.*, vol. ix. p. 555.); but Mr. Gorrie has shown (*Ibid.*, vol. x. p. 546.) that this is not likely to be the case. Mr. Matthew, finding the rot in trees which had been chilled in wet cold clays, and in others which had been starved in dry sand, and, again, in the most luxuriant-growing plants, in open situations,

branched to the ground, and growing in deep soil free from stagnating water, concludes that there must be "some constitutional tendency to corruption in the larch," which is excited by a combination of circumstances; and that we must limit our knowledge, for the present, to the fact that certain soils, perhaps slightly modified by other circumstances, produce sound, and others unsound, larch. According to Mr. Munro and a writer in the *Quarterly Journal of Agriculture*, the rot has even made its appearance in the mountain plantations of Dunkeld, in many situations, more especially in those which are moist.

Canker. It has been found, at Athol and Dunkeld, that, when larch is planted on soil that has borne crops of corn, it cankers; and this is the case, also, when it is planted in wet situations. Among the larch plantations formed since the commencement of the present century, Mr. Munro informs us, a malignant distemper has broken out, which resembles the canker in apple trees. "First a branch gives way; then a black liquid issues from the point of union with the trunk, the regular ascension of the sap seems to be impeded, and the albumen is disposed in rather large quantities on each side of the affected part, which gives the tree a very unsightly and gibbous appearance." (*Gard. Mag.*, vol. ix. p. 553.) Any attempt to cure this disease by external application, Mr. Munro holds to be ineffectual; but he thinks it may be prevented by using transplanted plants, and carefully planting them. This disease is not mentioned by any other writer, unless it be the blister mentioned by the editor of the *Quarterly Journal of Agriculture*, and in the editor's letter to Professor De Candolle (*Bibliothèque Universelle*, February, 1835, p. 115.), as "another disease incidental to the larch, which threatens to involve larch plantations in serious consequences." (*Quart. Journ. Agr.*, vol. v. p. 404.)

Culture and Management of the Larch on the Estates of Athol and Dunkeld. We have thought it better to give the mode of culture practised on these estates in a connected relation, than to separate it into fragments, and place it under the different heads already given; because the practices employed, and the results obtained, will in this manner be better understood, and more likely to lead to useful deductions by the reader. John Duke of Athol gave a short notice of his plantations to the Commissioners of Naval Revision in May, 1807, which was published in the *General Report of Scotland*, vol. iv. p. 498.; but by far the most complete account is that published in the *Highland Society's Transactions*, drawn up from papers and documents communicated by His Grace's trustees to the Highland Society of Scotland; from which we have already quoted the history of the Athol and Dunkeld plantations. The following abridged quotations will describe the mode of culture pursued, and the results obtained or anticipated.

It is observed by the editor of the *Quarterly Journal of Agriculture*, that the practical sagacity of the late Duke of Athol confirms in a most remarkable manner the theory of M. De Candolle, on the proper soil, situation, and culture of the larch. The duke began without much experience; but, in the course of practice, he found that "elevated situations were better for the larch than low ones; that declivities were better than flats; that 15 ft. or 16 ft. was the best distance at which larch plants could be planted asunder; and that they should be planted in autumn, in preference to spring." This, in short, may be considered the essence of the duke's experience. As introductory to the observations which are to follow, we cannot help noticing the great pleasure which the duke seems to have taken in his different plantations; some extracts from his memorandum-book reminding us of Evelyn's *Diary*, and of passages in the letters of the Earl of Fife, the greatest planter in Scotland in his time, published in the early volumes of the *Transactions of the Society of Arts*. For example: "Drove up to Loch Ordie, and home by the back of Craig-y-barns every way much gratified with the growth of the larch and the spruce; a very fine, grand, picturesque drive, not to be equalled in Britain! The extent of the drive through the woods of my own planting, from 1 to 40 years old, is

15 miles." And many other passages of a similar nature. The following is abridged from the *Highland Society's Transactions* :—

"The experience acquired during a period of more than half a century, in forming all kinds of plantations, suggested to the duke many improvements in the mode of planting trees in general, and particularly that of the larch, and the treatment of that wood during the progress of its growth. The result of that experience has introduced a simple, cheap, and efficacious mode of inserting larch plants into the ground. It has also determined the proper age of the plant at which it should be planted, so as it may acquire the greatest state of perfection at the earliest possible period. It has indicated the proper number of plants to be employed in planting an acre, both in low and high situations. It has proved, beyond dispute, the capability of the larch not only to vegetate, but to thrive luxuriantly, in elevations far beyond what were previously prescribed for its locality; and it has shown that larch timber may be judiciously employed in the construction of the largest class of vessels. The late duke carried on all his plans in planting systematically, which enabled him to detect any improvement on every new trial. Every new trial did, in fact, discover some improvement on the former, till the very last plantation which he executed gave him greater satisfaction in the work than all the preceding. Seeing the advantages of enclosing the ground before planting it, as practised by his father, in preserving the woods from the depredations of men and animals, he enclosed every piece of ground substantially with a high stone wall, dry built, for which there was abundance of excellent materials on the spot, before it was planted. Seeing, also, the disadvantages of allowing the wild shrubs to interfere with the growth of trees, he had them all previously removed by burning, pulling, and eradicating. These shrubs never grow to a troublesome height at an elevation exceeding 700 ft. above the level of the sea. At lower levels, most of them grow from 10 ft. to 12 ft. in height: the juniper pushes out strongly; and even the heath attains to the height of upwards of 2 ft. Feeling, too, the inconvenience of being shut out from viewing the interior of a plantation, he caused roads to be formed in every convenient direction through the grounds which were to be planted. These roads were not metaled, but they were made quite accessible to wheel-carriages, by the filling up of hollows, and the levelling of elevations; by making a ditch on each side of them, and sufficient openings across the hollows, to let off the superfluous water; and by running them across the face of acclivities, not only to avoid currents of water from the high grounds, but swampy places in the low grounds. Paths only of four or five feet in width were left in the highest parts of the ground, where wheel-carriages could not venture, but which were necessary as foot-paths for the inspection of the woods. These roads and paths were always formed before the ground was planted, as the lines of them could then be more easily traced on the ground. It was not found necessary to drain the acclivities of the mountains. Open cuts were formed in low swampy grounds, which were always planted with spruce instead of larch, as being a tree more suited to that particular state of the ground.

"*The Season of planting the Larch* commences as soon as the last year's shoots are entirely stripped of their leaves. In seedlings, this does not take place till the end of November or the beginning of December. About the 12th of April, the buds of the larch break forth rapidly into leaf. So that 65 days will embrace the longest period which can be allotted to the planting of the larch. With a planting instrument one man will plant from 800 to 1000 larches in a day; and, if 2000 plants are allowed to a Scotch acre, the cost per acre will be two days' wages of a man.

Age of the Plants, and Mode of Planting. "Finding great difficulty in collecting a sufficient number of 3 or 4 years transplanted larches, the age at which he had begun to plant, the duke resolved, previously to the planting of the large forest of 2409 acres, begun in 1800, on trying one or two years seedlings, or at the oldest one-year transplanted plants. After the large

shrubs were entirely removed, young and small plants seemed more desirable than large ones, especially as young ones could be inserted with greater facility into the ground, and at much less cost than old ones. The plant of making pits with the spade is always an expensive one; and the planting in pits can never be accomplished without the assistance of two people, one to hold the plant upright, and the other to shovel in the turf and the earth with the spade. The turf being thrown on its back into the bottom of the pit, to facilitate its rotting, it forms a serious obstacle to the expansion of the tender roots of the young plant. These pits, when made in the beginning of winter, get filled with rain water or melted snow; and, even should the plants be inserted into them when they are in a dry state, the water will afterwards run into the hollow around the plant. This hollow in the top of the pit is formed from the circumstance of the earth, which had been taken out of it at first being unable to fill it again. This is a property of mould well known to planters and labourers. The roots of the plants become chilled. Three or four years old transplanted plants may be so chilled in this manner, as to prevent their pushing out a shoot above 2 in. in length in one season for several years. The slit, on the other hand, formed by the planting instrument, resists all ingress of wetness or cold, the surface closing together as if it had never been cut; and the natural grassy covering protects the young plant from the severer effects of the frost. A one-year-old transplanted plant or a seedling, when inserted into a slit in the ground, takes immediate hold of the mould below, and grows onwards without molestation from the weather. This plant instrument consists of a flat piece of iron, shaped like the head of a flat spear or a mason's trowel, 10 in. in length, and 5 in. in breadth at the widest part. Its neck, which is of one piece with the blade, is 7 in. long, and passes through and is riveted to a cross handle of wood, that remains firm in the plane of the blade. The whole instrument is made stout, and of the best materials. It costs only 1s. 6d. In using this instrument, the planter holds it in one hand, and the plants in the other; and he makes a slit in the ground of the requisite depth for the plant to be inserted; then pushing the roots of the plant carefully into the slit, so that they shall not point upwards, he finishes the operation by treading with his heel the ground firm around the plant.

"*The Expense of Labour in planting* was greatly reduced by the use of this instrument. Pit-planting required 20 men to pit and plant an acre in a day; whereas two men will do the same work, in the same time, with the spear-planter. The three and four years old transplanted larch cost 10s. per 1000; the seedlings only cost 2s. 6d. per 1200. But, besides this direct saving of expense in employing the slit to the pit planting, there is the advantage of scarcely one plant going back by the former mode; whereas, by the latter, many go back, which are obliged to be filled up afterwards with fresh plants, creating an additional expense; and many that continued to grow assumed a sickly hue for some years after they were planted."

Here three tabular views are given, by which it appears that two-years-old transplanted plants, that had been chilled in winter-made pits with cold and wetness, and which were 1 ft. 2 in. high when planted, were, after being 6 years in the pits, only 3 ft. 7 in. high. The same-sized plants, planted in spring-made pits, were, at the end of 6 years, 6 ft. 10 in. high; and the same description of plants, planted by slit, were 11 ft. 2 in. high in the same period; being no less than 7 ft. 5 in. higher than those planted in the autumn-made pits, at more than treble the expense.

Soil and Situation. "It is an error to suppose that the larch will thrive in all soils and in all situations. There are many kinds of soils in which it will not thrive, and ought not to be planted. It has been found that, in soils which have been turned up by the plough, and which have borne corn crops, the larch cankers: it cankers in wet situations also." On this passage, Mr. Gorrie observes, that he has not found the larch, generally, to canker when planted on land that has borne crops. "In soils resting on a clayey subsoil,

it decays at the heart, after arriving at 40 years of age. In situations where water stands for a length of time about the roots, it becomes covered with lichens; but in all rocky situations, and particularly those which are composed of mica-slate containing crystals of garnets, among the fissures and fragments of which they can push down their roots, larches thrive to admiration. The geognostic character of the country from Dunkeld to Blair is primitive. At Blair is gneiss, at Dunkeld clay-slate, and the intermediate space is occupied by mica-slate. They lie conformably to one another.

"*The Advantages resulting from planting Mountain Ground* appear, at first sight, in the greater number of trees that may be supported on the acclivity of a mountain, than on a surface equal to its base. Trees derive nourishment from the soil immediately around the place in which they are fixed; and, as the superficies of that soil must, of course, be greater on an acclivity than on the base, a greater number of trees will be there supported. Practically speaking, 100 trees at 6 ft. apart can be planted on the hypotenuse of a right-angled triangle, whereas the base would only permit 80 at the same distance. Another and a great advantage derived from planting mountain ground is, that, on an acclivity, the trees expose a greater surface to the influence of the sun, air, and rain, than they can do on a level surface. The outside trees in a forest are always the strongest. On an acclivity they all possess the advantages of outside trees, and at the same time most of the shelter enjoyed by those in the interior."

Number of Plants annually planted. "From the great scarcity of arch plants at the commencement of the larch plantations at Athol, it was not possible to extend their cultivation beyond a very limited number or space in any one year. They were at first planted very little thicker on the ground, among other trees, than they would have been, had they been thinned out to stand for naval purposes. Generally, in mixed plantations, they were put in from 700 to 1000 plants per acre. In the first attempts at planting them entirely by themselves, they were increased only to 1500 plants per acre, from the want of plants. The keeping of the plants in the nursery grounds till they were 3 and 4 years transplanted from the seed-bed, tended greatly to decrease the disposable quantity of plants from such sources. Finding 1500 plants rather too few among broom and furze, they were increased to 1800 per acre. Even after one-year-old seedlings were planted, which practice immediately threw an immense number of plants into the market, they were only extended to 2000 per acre, on the higher and barer parts of the mountain range: 2000 per acre, the duke thinks may be considered by many thin planting, and up to the region of broom and furze, that number may have enough to do to contend with them; for, however these shrubs might have been subdued for a time, and, in many places, completely eradicated, yet, in more favourable situations, they would spring up again, were there not a sufficient number of trees to overtop and keep them down, by the exclusion of the pure atmospheric air. It must be observed, however, that were 3000 plants planted per acre, that would only bring the trees about half a foot closer to each other; whereas the lower branches of the 2000, having plenty of air, will meet one another when the plants are only eight years old from the seed, and they will then entirely prevent the growth of the shrubs. But, in the higher region, beyond the growth of the larger shrubs, 2000 plants per acre, the duke maintains, are not too few, when it is considered, in the first place, that this open planting delays greatly the period of thinning, and, of course, curtails expense, which is an object of consideration in large undertakings. In the next place, it is well known, that the lower branches of the larch assist more than any of the others to strengthen the roots, and increase the thickness of the base of the trunk of the tree. Strength of roots and a good girth give great stability to trees exposed to the fury of the elements in a mountainous country. The tops of the larch vibrate in the blast like the points of fishing-rods. By the time they are thinned, they will individually be able to withstand great blasts of wind with impunity. Besides, the lower

and larger branches being permitted to remain for a considerable time, they will, during that period, have deposited a large quantity of leaves for the nourishment of the ground below. The first thinning will be of such value as to compensate for the great labour of performing it, when it is thus long delayed; and it could not have been so long delayed, had the trees been planted thicker. The duke seems to be aware that the opinions of many planters, and many practical ones too, run counter to the practice of thin planting, as recommended by him; but it is questionable whether any of them has had the experience of rearing larch to the height of from 700 ft. to 1600 ft. above the sea. At that elevated region, it appears to the duke proper to follow the dictates of experience, rather than those of custom; and, though he may himself have, perhaps, at first adopted it from necessity, arising from a difficulty of obtaining plants, he continued it when that necessity no longer existed, because he had seen the good effects arising from it. Thin as 2000 plants may appear on an acre, they will only stand 5 ft. 3 in. apart."

The Process of the Thickening of the Soil by the Larch is one very important in its results; and we have already given it in p. 2373.

Comparative Effect of the Larch with other Trees in improving the Soil. "In oak copses, the value of the pasture is only 5s. or 6s. per acre for 8 years only in every 24 years, when the copse is cut down again. Under a Scotch pine plantation, the grass is not worth 6d. more per acre than it was before it was planted. Under beech and spruce it is worth less than it was before; but the spruce affords excellent shelter to cattle, either from the heat of summer or the cold of winter. Under ash, the value may be 2s. or 3s. per acre more than it was in its natural state; but under larch, where the ground was not worth 1s. per acre, the pasture is worth from 8s. to 10s. per acre, after the first 30 years, when all the thinnings have been completed, and the trees left for naval purposes, at the rate of about 400 to the acre, and 12 ft. apart."

Thinning. "The great object of the late duke seems to have been to raise larch timber on his property fit for naval purposes. With that view, he planted his trees, and thinned his plantations. No demand for wood for mere country purposes would have warranted him to plant so extensively as he did. He found that larches could grow to a great size at only 12 ft. apart; and this distance gives 380 trees to the Scotch acre, which is little more than one fifth part of the 2000 per acre originally planted. The first thinning should be a slight one, of about one fifth of the whole, by removing only those trees that are of least value, or worthless. After 24 years from the time of planting, the leaves fall off the lower branches, which are, of course, no longer useful to the soil below. From 20 to 30 years old, the thinning is carried on so extensively as to remove two thirds of those trees which were left standing by the first thinning. In thinning, it is necessary to observe that all the strongest and healthiest trees should be left, even if two or three of them should be closer together than 12 ft. These small clumps happening to light on a favourable situation, they will thrive well, as the air has access to each tree, around two thirds of its circumference. This thinning being delayed so long, the trees thinned out will be valuable for a variety of purposes. One of these purposes is the profitable use which may be made of the bark. The last thinning should be given when the trees are from 30 to 35 years old, which will leave from 380 to 400 trees per acre. The 380 will require a little pruning and trimming of the lower branches, in order to give head room to the cattle which are to browse on the grass below. The whole prunings and thinnings will cost about 5l., and their produce will fetch about 12l., leaving a profit on them of about 7l. an acre."

Planting the Scotch Pine along with the Larch. "The rapid growth of the young larch trees, even in exposed situations, is certainly matter of surprise. This property convinced the late duke of the inutility of providing nurses for them. His gardener, Alexander Macrostie, whose name as a planter the duke mentions with approbation, and who was at the head of all His Grace's plantations, thought proper, during the duke's absence, to fill up with Scotch

pine, as nurses to the larch, some part of the plantations which had been made about the year 1800, before the period of seedling plants being used. This, as the duke observes, was 'the dwarf nursing the giant.' In 1817, most of these Scotch pines had not attained a height exceeding 3 ft., while the larches, which they were intended to nurse, were from 15 ft. to 20 ft. high. In the lower part of the same plantation, where the Scotch pine had grown to 20 ft. in height, the larch exhibited a stature of from 30 ft. to 40 ft.; and, in the instance before referred to, in an elevated situation, at 900 ft. above the sea, where the Scotch pines were more than 42 years old, they were only 5 ft. and 6 ft. high; whilst the larch, in the same situation, and planted 10 years after them, had reached up from 40 ft. to 50 ft. in height. In 1816, the duke measured a larch, on a pinnacle of the highest ridge of the ground alluded to above, at only 9 years after planting, which was quite straight and vigorous, and stood 16 ft. high, and the nearest Scotch pine to it was only 2 ft. 6 in." On this passage, Mr. Gorrie remarks, that the Scotch pine should never be mixed with the larch in plantations, as it will produce rot.

Rate of Growth of the Larch. "Taking the average height, then, of an average larch of 8 years from the seed at 11 ft., it will be nearly accurate to allow 16 in. as the annual growth, till the tree is 50 years old; and after that, only 10 in. per annum, for 22 years longer, as the length of the tree lessens in growth as the bulk of the wood increases. These data give a larch tree of 72 years of age a height of 93 ft. 4 in.; a fair average, agreeing with actual experiment. The shoots of larches beyond 35 years of age are heavier, though they are not so long as those of younger trees. The larch, like the oak, puts forth two shoots every year, the one in spring, the other in autumn. The spring shoot has no lateral branches: the autumnal shoot pushes out like the spring one; but, at the time this process is going on, the spring one is throwing out lateral branches. These lateral branches are firm and woody. In regard to the growth of the girth, a larch tree, on an average, will acquire 1 in. in girth per annum, till it be 24 years old; and from that time, till it has acquired the age of 72 years, it will grow 1½ in. in girth every year; thus,

In 24 years, it will be 2 ft. in girth, at 1 in. per annum.
48 — more 5 — 1½ —
In 72 — it will be 7 ft.

The larch begins to make wood at 24 years of age..

At 50 years old, it will contain 26 cubic feet of wood.			
60 — —	14 —	more.	—
72 — —	20 —	—	—

In all, 60 cubic feet of wood; or one load of 50 cubic feet, and 10 ft. more.

"These results correspond exactly with the quantities which the duke obtained at these respective ages. Larch appears to be on its greatest increase for timber from 57 to 72 years old. A larch containing 50 cubic ft., or one load of timber, is quite fit for naval purposes. At half that size it is suitable for every country purpose.

"A few Examples of the sizes of the timber which the duke felled may not prove uninteresting. In 1806, twenty larches, at the age of 64 years, were cut for centres to the bridge building at Dunkeld. These trees having been drawn up by close planting, they were from 105 ft. to 109 ft. in length; their girths were from 5 ft. to 5 ft. 4 in.; and they averaged from 80 to 90 cubic feet of timber. In 1810 and 1811, 600 trees were felled at Dunkeld and Blair, to send to Woolwich dockyard, the aggregate amount of which was 606 loads. The timber was much admired by the best judges. One of the logs contained 83 ft. of wood.

"The Larch will thrive better in a northern than in a southern Exposure, till it is about 30 years of age; but, after that period, there is no perceptible difference. This circumstance may be explained by the favourable effect of an equable temperature on the health of trees. The vicissitudes of frost and thaws must

produce a greater effect on the sunny side of mountains than on the opposite. The tallest larches do not always contain the greatest quantity of timber, as is instanced in the case of two trees which were felled on the 1st of June, 1829, aged 82 years. The one, which was only 97 ft. in length, yielded 138 cubic feet; while the other, which was 104 ft. in length, only gave 81 cubic feet.

“One of the greatest Advantages of planting Larch is derived from its peculiar property of thriving in very elevated situations. Immense extents of mountain ranges may thus be applied to useful purposes, which otherwise would have been quite unavailable. The Scotch pine thrives at an elevation below 900 ft.; but the larch ascends to 1600 ft. above the sea, and it may ascend higher. This is an important fact, in a national point of view. Much of the mountain land of Great Britain, which is at present worthless, may grow timber to supply her navy and merchant shipping, without at all interfering with the land which produces her cereal crops, or even her fine pasture land in a lower situation. But here the duke anticipates an objection which might be started by some, and that is, whether the larch will certainly become useful timber at these elevations. ‘An argument,’ says he, ‘may, indeed, arise, whether, all the upper part of the mountain being rugged, trees can grow in many parts to stand for timber, at 400 per acre. Reasoning from the experience of 43 years, which proves trees fully to that extent per acre to contain 10 or 15 cubic feet or more of wood already to exist, I am clearly of opinion that 400 trees may grow, within 70 years, to average one load of wood or more, at a height of from 1200 to 1600 ft. above the sea; and the researches which the larch makes with its roots among the crevices of the rocks and the shivered fragments are such, and the ground so found being virgin soil, that, along with the rains and mists imbibed by the tops, and invigorating the trunk, I am quite convinced they will have the effect to produce a load of timber, or more, within the period mentioned. Some of the trees, of the age of 57 years, cut in 1816, among rocks fully as rugged as those described, exceeded 60, and some 70, cubic feet of wood; and the 223 cut from similar situations averaged, at 57 years of age, 40 cubic feet of timber, laid down at Woolwich dockyard in 1817.’

“Mountain Planting may be very well illustrated by the following diagram; in which the space occupied by the larch is seen to exceed greatly in height the site of every other species of useful tree. It also occupies, in common with the other trees, the ground at the lowest level; so that its range of growth is extensive.

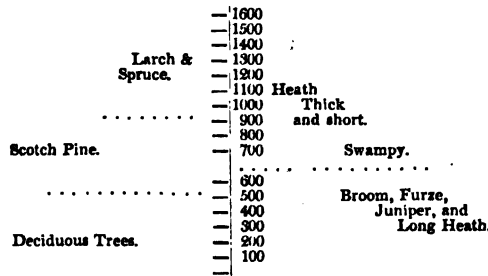

“These elevated regions are far above the range of the vegetation of the Scotch pine. This is a dull heavy-looking tree in large plantations: it cannot withstand a strong wind; and it decays, in Britain, after it has attained an age of from 70 to 80 years. The larch is quite the opposite in all these respects; and it will supply ship-timber at a great height above the region of oak. Besides the almost immeasurable extent of ground thus obtained, by means of the larch, for the growth of ship-timber, it is a more profitable tree in that respect than the oak. An English acre of larch, at 12 ft. apart, will give 302 trees per acre.

				Loads.	ft.
100 larch trees, at 64 years old, would give 1 load per tree,	=	100	0		
100 — — 68 — — — 1 — —	=	100	0		
102 — — 72 — — — 1 — —	=	102	10		
<hr/>					
302 trees, at an average of 68 years old, would give	-	322	10		

It is said that 3000 loads of timber are required to build a 74-gun ship. Ten acres, therefore, of larch would easily supply that quantity. Now, an English acre will only grow 40 oaks at 34 ft. apart, the distance required for their growth; and, allowing oak to yield a load of timber at 68 years of age, that would only yield 40 loads of timber per acre; or, in other words, it would require 75 English acres to supply the requisite quantity of oak to build a 74-gun ship.

Accidents and Diseases. "The larch, like other trees, is liable to accidents and diseases. Wind may drive them down by the roots, but it can very seldom break them, which shows the toughness of the wood. In November, 1826, a hurricane was very fatal to the Scotch fir, and it tore up many larches by the roots. The depredations committed by wild animals are sometimes considerable, such as those done by red deer, the roe, hares, rabbits, and even the black game. Fences of good stone walls will certainly form a powerful barrier against the inroads of all these creatures; but still they find an entrance into the woods by gateways, and such like openings, for the sake of shelter. The red deer but seldom leave their more herbaceous pasture about Blair; but the roe deer commit considerable depredations about Dunkeld, insomuch that war was obliged to be declared against them in 1816; and in that season, 170 were brought in dead; and others, dying from wounds, would swell the number of slain, that season, to upwards of 200. Before 1774, the roe deer were not known to exist nearer than 30 miles to Dunkeld; and then they were scarce any where; but, since they have received shelter and protection from the numerous young plantations, they have increased very fast in numbers. Their habits are peculiar: they always go in herds of odd numbers, from 3 to 9. The doe generally produces two at a birth, and can rear them easily: but one or both of the fawns are often destroyed by the foxes. The weight of a good buck with the skin, but without entrails, is 40 lb.; that of a doe from 32 lb. to 38 lb. The principal mischief committed by them is by the buck rubbing his horns between two trees, to get rid of the velvet which covers them. A dozen of trees may be seen at one view, of from 7 to 8 years of age, completely stripped round of their bark. Both the buck and the doe eat the tops of the young larch. Hares and rabbits, but particularly the former, appear to be seized with an idle but mischievous curiosity to taste the tops of a new plantation in its first year's growth, though they never eat the tops they nip off. Not destroying for the gratification of hunger, their depredations are the more extensive. Black game, too, nip off the tops of young plants for a year or two, but they never eat them. Plantations above 700 ft. of elevation are only annoyed by the deer.

Larch Blight. "Previously to the year 1795, a blight (occasioned by an insect) affected the larch, and of those in low situations many died. At that time the frost was very severe, and heavy frosty fogs hung about the trees in spring. After this phenomenon, the blight appeared. Trees above 30 ft. in height, and in high situations, escaped this affection, where the wind could shake them. This blight destroyed the flower of the larch, and prevented the formation of the seed, and consequently the propagation of the plant. The first appearance of the blight was indicated by a substance on the larch, resembling small balls, of a fine white matter like cotton. These balls, or nidi, enclosed small insects, a species of aphis, the two sexes of very different appearance. They appeared to live upon the juices exuding from the bark of the tree, and not upon the leaves; and they probably prevented the sap from ascending, at least no fresh shoots were thrown out by the tree that season. Many trees were much injured by this disease; and, for a long time afterwards, they presented a remarkable appearance, that of being completely covered over with lichens.

The trees, however, shot up clean stems 20 ft. to 25 ft. above the part covered with moss; and these stems were as healthy as those of the healthiest trees, that had never been affected. On cutting the wood, the covered part was no more injured in quality than the wood of the healthiest trees, though the lichen had adhered to them for 15 years. The effect of this blight, then, was only superficial. The existence of this disease for 8 or 10 years certainly retarded the growth of the trees; but it did not cause the duke to relax in the least in his efforts to form large larch forests: on the contrary, it impressed upon him the necessity of planting the high ridges of the mountains, in order that the trees might be placed beyond the influence of the disease, which did not appear higher than 600 ft. above the level of the sea.

"In *Felling large Trees of Larch*, care must be taken to use plenty of rope, and to take advantage of the direction of the wind. A windy day should be avoided. It was found that, in digging the Scotch pine out by the roots from among the larch, the ground was much shaken about the roots of the larch, so as to endanger their stability. Ever after, the pine was cut over by the ground.

"*The Seasoning of Larch Timber* is accelerated by stripping off the bark before felling. In May, 1815, the duke experimented on 50 trees of larch at Dunkeld, that were growing in a situation, among other wood, that was nearly inaccessible for want of a road or path to it. In 1816, they were cut down and used for several purposes, and they appeared to be completely seasoned. They contained 25 cubic feet of wood each. Larch trees that had been only 10 months cut down were built into a steam-boat on the river Thames; but they had not been seasoned enough, as the planks above water, near the deck, shrunk a little. In this case, however, the scantlings were made the same as of oak, which were of too slight dimensions for larch.

"*The probable future Supply of Larch Timber from the Woods of Athol* is thus calculated by the duke. The experiments performed on the value and durability of larch, as ship timber, were performed chiefly on the 1900 trees planted by Duke James, and which had attained a serviceable size during the time of the late duke. Of them only 800 or 900 were left as ornaments about the lawns and parks of Dunkeld and Blair. Unfortunately, a blank of 15 years took place in the planting of larch by Duke John. To compensate, as far as was in the power of the late duke, for this great deficiency in the regular supply of timber, he resolved, in 1817, not to cut any trees for ship-building till the year 1832; thus sacrificing his own personal emolument for the sake of the estate. The most of the trees planted by Duke John were too young for ship-building. After 1832, the annual cuttings for ship timber may be calculated at the following rates:—

		Loads,		The produce	
		1820 annually.		of Acres.	
12 years cutting after	1832 to 1844 =	1,920	—	}	9000
10 — — —	1844 to 1854 =	8,000	—		
8 — — —	1854 to 1862 =	18,000	—		
8 — — —	1862 to 1870 =	30,000	—		
16 — — —	1870 to 1886 =	52,000	—		
18 — — —	1886 to 1904 =	190,000	—	3000	
		72	—		

"*The Value of Larch Timber* may be seen from the prices which the duke received for it for various purposes. In 1806, the duke cut 20 larch trees of the age of 64 years, to make the centres of the middle arch, of 90 ft. span, of the bridge that was building across the Tay at Dunkeld. They were from 105 ft. to 109 ft. in length, and they contained from 80 to 90 cubic feet of timber each. After standing .or 3 years as centres, they were sold by public sale, at 2s. 8d. per cubic foot. In 1810, Messrs. Symes and Co., ship-builders in Leith, bought 11 trees, producing 1066 cubic feet, at 3s. per foot. In February, 1819, the duke sold to Messrs. Bolton and Watt, and laid down for them at Evan's Yard, London, 4176 cubic feet of larch, at 3s. 6d. per foot, for the building of steam-boats. Mr. Ainslie, ship-builder, Perth, bought 500 trees, yielding not less than 12 ft. each, at 1s. 6d. per foot; the buyer paying all expenses of cutting down and carrying away. The duke also supplied

larch for the building of 2 brigs at Perth; the one, the brig Larch, built by Mr. Brown, of 171 tons register; and another, of 240 tons, built by Mr. Ainslie.

"*The Value of Larch Wood, exclusive of the Value of the Pasture under it*, may be estimated in this manner:— Suppose the plantations are thinned out by 30 years to what they are to stand for ship timber, that is, to 400 trees per Scotch acre; suppose, after that period, the whole were cut down at the following respective ages, the value of the whole per acre, at the different periods, would be as follows:—

	<i>£ s. d.</i>
400 Trees at 30 years old, at 2½ cubic feet each tree, = 1000 cubic feet, or 20 loads, at 1s. 6d. per foot profit, = per acre	75 0 0
400 Trees at 4½ years old, at 15 cubic feet each tree, = 6000 cubic feet, or 120 loads, at 1s. 6d. per foot profit, = per acre	450 0 0
400 Trees at 59 years old, at 40 cubic feet each tree, = 16,000 cubic feet, or 320 loads, at 2s. 6d. per foot profit, = per acre	2000 0 0
400 Trees at 72 years old, at 60 cubic feet each tree, = 24,000 cubic feet, or 480 loads, at 2s. 6d. per foot profit, = per acre	3000 0 0

"The average of these prices would be 1381*l.* 5*s.* per acre; so that 1000*l.* per acre is not too high a calculation of the value of the duke's larch plantations.

"*The comparatively superior Value of Larch to Oak per Acre* has already been alluded to, when the comparative quantities of timber per acre were made out, by a statement in favour of the larch. In comparison to Scotch pine, as a comparison of one kind of fir with another, the difference is still more striking. Fifty larch and 50 Scotch pine trees were cut out of the same plantation. The average contents of the fir were 8 cubic feet, at 1*s.* 3*d.* per foot, or 10*s.* per tree. The larch averaged 30 cubic feet each, and fetched 2*s.* 6*d.* per foot, or 3*l.* 15*s.* per tree. So that the larch was superior in contents 3½ times, and in value more than 7 times, to the Scotch pine.

"*The superior Value of the common Larch, when compared with the Russian Larch.* The duke, having heard of the valuable properties of the Russian larch, with some difficulty procured the seed of it from Archangel, reared the plants, and planted them out, in-number about 200. They shot out about 8 days earlier than the common larch, but they did not attain to one third of its size in the same time; and, both in their appearance as trees, and their value as timber, they were found much inferior to the common larch.

"*The Uses to which the Larch Tree may be applied* are various and important. In one instance, the duke applied larches successfully as nurses to spruce firs, which were going back. The requisite shelter recovered the health of these valuable trees. The great thinnings of larch plantations, which take place from 20 to 30 years of their age, supply useful materials for various purposes. Posts and rails for fencing may be made either out of the tops or the trunks of young trees. While fir posts and rails last only about 5 years, and are wormeaten after that period, the larch posts stand for 20 years, and never get wormeaten. But the trunks of young trees are preferable for this purpose to the tops, as they have less sap wood. In 1807, the duke fenced a nursery ground with young larch trees cut up the middle, made into a railing 7 ft. high. In 3 years after, the sawn side assumed a leaden-grey colour, and in 1817 the whole railing was quite sound. The railing round the lawn at Dunkeld, made out of the tops of trees, was taken down in 1818, after it had stood for 10 years. Six inches only of the posts were decayed under ground, which being cut off, the rail was nailed up again. A rustic bridge was thrown over a high road and a ravine, as an easy access to the nursery ground, which remained, in 1817, quite sound.

Tanning. "About the year 1800, the tanning properties of larch bark were tried by a tanner at Perth, by the duke's desire. It succeeded tolerably well; but the tanner complained that the bark had not half the strength of oak bark. The bark of old trees cut at Blair, the duke found quite unsaleable. The duke was not at all sanguine about the bark of the larch affording a valuable tan; but, in fact, though more encouraging markets had been found for it, it is questionable whether the loss arising from the deterioration in the quality

of the wood, by being cut full in the sap, did not counterbalance all the advantages derived in the shape of increased value of bark. Even in the case of young trees which were appropriated to posts and rails after having been peeled for their bark, great expense was incurred in paint, in order to preserve the rails after they were deprived of their bark, which is a great preservation to posts and rails. If any profit is to be derived from larch bark to the grower, it must be from the produce of that great thinning which takes place when the trees are from 20 to 30 years old. The making of a road, in June 1819, to carry off the wood from the top of Craig-y-Barns, gave the duke a favourable opportunity of trying the peeling of the bark from trees that were cut down at that season of the year when the sap was quite full in them. Some of the trees, that were 50 years old, peeled from end to end without difficulty, and each of them produced from 5 to 6 stones Dutch of bark. Thickly planted trees of 33 years of age, and 37 ft. in length, and 25 in. in girth, 3 ft. from the but end, were also peeled, and they each yielded about a Dutch stone of bark. At an age of 20 or 21, and height of 28 ft., they yielded only half a stone; but even this small quantity, calculated at the current price of larch bark, at 10*d.* per stone, gave 5*d.* a tree, a price greater than any Scotch pine near them was worth altogether, of the same age." At present, Mr. Gorrie informs us, larch bark does little more than cover the expense of peeling, drying, and carrying to market; and that it now sells at from 6*d.* to 8*d.* per stone.

"*Larch Tops* which had lain cut for 4 years, and were, of course, well worn, were found useful in filling drains where stones were at a distance; and they continued sound in them for many years.

"*Larch Timber* was used for axles to different kinds of mills, from 1793 to 1802; and up to 1817 they continued quite sound, though constantly in water.

"*For Buildings*, the larch is found equally desirable. In 1779, the duke built the shooting-box in Glentilt, called Forest Lodge, the floors and joists of which were made of larch. The wood was under 40 years old; and, as an experiment, some of the deals were cut up narrow, and others as broad as they could be wrought. In 1817, the narrow boards continued quite close together. After the bridge was thrown over the Tay at Dunkeld, the duke altered the course of the great northern road to Inverness, which caused him to build new porter's lodge, stables, and offices to Dunkeld-House, near the new line of road. The whole woodwork of these buildings was executed with larch. They were finished in 1812. In 1813, part of Athol House was burnt down, and the repairs of wood, consisting of joists, floors, doors, and windows, were all made of larch. This wood was so red in colour, that it looked like cedar. Several houses were also repaired in the town of Dunkeld with larch. At Dunkeld 271, and at Blair 170, larch trees had been used, by 1817, for building purposes.

"*The first Attempt to use the Larch for the Purposes of Navigation* was in the construction of fishing-cobles on the Tay, in 1777. Previously to that, they were made of Scotch pine; and they lasted only three years, when they had to undergo a thorough repair. In fifteen years more, ferry-boats were constructed of larch, instead of oak, for the conveyance of passengers across the different ferries on the numerous rivers on the property. The oars, too, in the course of time, were made of larch, and they were found to be excellent in lightness, toughness, and elasticity. In 1809, 8491 cubic feet of larch timber were sent to Woolwich dockyard, the greatest part of which was employed in the repair of the Serapis store-ship in 1810; and the state of its soundness was favourably reported on in 1817. One beam of it was put into the large frigate Sybelle, in 1816, after it had lain six years in the dockyard.

"The next trial of larch in ship-building was in the Sir Simon Clerk merchant vessel, of 375 tons register, built by Messrs. Symes and Co. of Leith, in 1810; but, as that vessel was soon afterwards taken by the Americans, no account could be got regarding the durability of the timber.

Knee Timber for Larch Roots. "In order to dress the ground, and lay it

down properly to grass, upon which the sixty large trees sent to Woolwich had grown, the duke caused the large roots to be extracted out of it. After they were out of the earth, the duke was struck with their apparent capability of being cut up into knees for ships; and he immediately entreated the Navy Board to try them for that purpose, but the proposal was declined. Thus rejected, the fate of some of these roots, in the shape of knees, was curious, and is thus described by the duke:—‘ In 1811, an American vessel, the *Frances* of Baltimore, of 160 tons register, a brig, sustained very considerable damage on her voyage to Leith, and came in nearly a wreck. Messrs. Symes and Co., who repaired her, put into her some of these larch knees offered to the Navy Board. The captain of the vessel said he never saw any wood of so fine a quality, and so applicable for knees; and he was extremely urgent to know what kind of wood it was, and if he could get any more of it: but they had no more to give him.

“ *The Larch has been tried in a small Way as Masts.* Three sloops at Perth were fitted up with them; but, as they all soon left the Tay, its value as such could not be ascertained.

“ *The great and important Trial of the Larch, as a valuable Tree for naval Timber,* was made from 1816 to 1820, in the building of His Majesty’s frigate the *Athol*. Her keel, masts, and yards were made wholly of larch. She was launched on the 21st of November, 1820. Her dimensions are as follows:—Length of deck, 113 ft. 8 in.; keel for tonnage, 94 ft. 3½ in.; extreme breadth, 31 ft. 6 in.; moulded, 31 ft.; depth of hold, 8 ft. 6 in.; admeasurement, 499¾ tons. She carries 20 guns of 32 lb., 6 guns of 18 lb., and 2 guns of 6 lb.; in all, 28 guns. Her main, fore, and mizen masts, with their topmasts and topgallant-masts, and their respective yards, bowsprit, sprits, and tops, tit-booms, and speding-booms, were all of larch. She drew of water, afore, 8 ft. 11 in.; and abaft, 11 ft. 3 in. When launched, her weight was 267 tons. Many minute inspections took place at different times, by competent judges, of the state of the larch in the *Athol*, and all are very laudatory of its qualities as ship timber. The following important particulars regarding the larch in general were related by Mr. Symes of Leith, after he had inspected the *Athol* in Leith Roads, in July, 1824. The larch becomes harder and more durable by age in a ship. It holds iron as firmly as oak; but, unlike oak, it does not corrode iron. Iron bolts may be driven out afterwards perfectly clean. It does not shrink: the *Athol* had been caulked but once in four years. It possesses the valuable property of resisting damp, inasmuch as the pump-well was as dry as the cabin. This is a very important fact, as regards the durability of the ship, and the health and comfort of the crew. The beams and knees in the gun-deck were as well finished as the best joiner’s work, and they had no appearance of shrinking or straining. The *Larch*, a brig, the *Diana*, a steam-vessel, and other ships, were afterwards built of the larch, and all with favourable results.

Incombustibility of Larch Wood, and its Property of not splintering. “ Among the properties of larch which may be considered as valuable in respect of ship-building, is the one of its being slow of kindling by fire. Though hot embers be thrown on a floor of larch, it will not get suddenly up into a blaze, like other kinds of fir. It is admirably adapted to be formed into wooden steps for guard-ships or quays, the edges of them not breaking or splintering like other fir wood. The property of its not splintering makes it a valuable wood for the upper works of men-of-war. The splinters made by cannon-shot are often more hurtful to the seamen in action than the shot themselves. A shot-hole through larch closes and does not splinter. Larch treenails were allowed by Sir Robert Seppings to drive remarkably well.

“ *The Products arising from the chemical Treatment of Larch Wood* may be useful to the arts. The following results were obtained by chemical experiments made by Mr. Brown of Old Brompton, on the 19th of March, 1828. A piece of larch wood of 6 lb. weight was placed in a retort, which was heated

to a red heat, and $31\frac{1}{2}$ cubic feet of olefiant gas came over. This gas was not fit for the purposes of illumination. Of crude pyroligneous acid, there was $1\frac{1}{2}$ pint. Half a gill of tar, of superior quality to that made from coal, and 1 lb. 9 oz. of charcoal were the rest of the ingredients obtained. The pyroligneous acid, in the crude state, is sold in large quantities at 7d. per gallon. It may be obtained from the loppings of the larch trees. Charcoal, in large quantities, varies in price from 1s. 7d. to 1s. 8d. per bushel. Pieces of wood 29 in. in length, and 4 in. in diameter, could easily be converted into charcoal, for which there is a demand in this country to the value of 10,000l. yearly."

Some examples are next given of the *elasticity, durability, strength, and resilience* of larch timber; but, as they are at great length, and illustrated by minute tabular details, and as the general results have been given in a preceding part of this article, we omit them, and refer the reader to the original paper in the *Highland Society's Transactions*, vol. xi. p. 165. to 219.

Statistics. Near London. At Syon, it is 79 ft. high, the diameter of the trunk 2 ft. 8 in., and of the head 42 ft.; at Gunnersbury Park, 33 years planted, it is 60 ft. high.—South of London. In Devonshire, at Griston, 21 years planted, it is 51 ft. high; at Killerton, it is 73 ft. high, the diameter of the trunk 3 ft., and of the head 34 ft.; at Bystock Park, 21 years planted, it is 50 ft. high; at Endsleigh Cottage, 22 years planted, it is 80 ft. high. In Dorsetshire, at Melbury Park, 55 years planted, it is 60 ft. high. In Hampshire, at Strathfieldsaye, it is 130 ft. high, the diameter of the trunk 3 ft. 6 in.; at Alresford, 41 years planted, it is 72 ft. high; at Testwood, 70 years planted, it is 80 ft. high, the diameter of the trunk 2 ft. 6 in., and of the head 30 ft. In Somersetshire, at Leigh, it is 90 ft. high, the diameter of the trunk 2 ft. 6 in. In Surrey, at Bagshot Park, 22 years planted, it is 40 ft. high. In Sussex, at Cowdrey, it is 55 ft. high, with a trunk 4 ft. in diameter; at Slaugham Park, 9 years planted, it is 24 ft. high. In Wiltshire, at Longford Castle, 5 years planted, it is 30 ft. high.—North of London. In Bedfordshire, at Flitwick House, it is 75 ft. high, with a trunk 2 ft. 6 in. in diameter. In Berkshire, at Bear Wood, 14 years planted, it is 30 ft. high. In Denbighshire, at Llanbede Hall, 45 years planted, it is 55 ft. high. In Durham, at Southend, 18 years planted, it is 45 ft. high. In Essex, at Audley End, 36 years planted, it is 60 ft. high. In Herefordshire, at Hatfield, 15 years planted, it is 45 ft. high. In Herefordshire, at Aldenham Abbey, 34 years planted, it is 75 ft. high, the diameter of the trunk 2 ft., and of the head 30 ft.; at Chesunt, 13 years planted, it is 30 ft. high. In Leicestershire, at Donnington Park, 60 years planted, it is 86 ft. high, the diameter of the trunk 2 ft. 6 in., and of the head 43 ft.; at Belvoir Castle, 14 years planted, it is 40 ft. high. In Monmouthshire, at Tredegar, 55 years planted, it is 60 ft. high, the diameter of the trunk 4 ft., and of the head 66 ft.; at Dolwais House, 10 years planted, it is 16 ft. high. In Nottinghamshire, at Clumber Park, it is 78 ft. high, with a trunk 3 ft. 3 in. in diameter; at Worksop Manor, 120 years old, it is 95 ft. high, the diameter of the trunk 3 ft., and of the head 101 ft. In Northamptonshire, at Wakefield Lodge, 14 years planted, it is 32 ft. high. In Northumberland, at Hartburn, 83 years planted, it is 89 ft. high, the diameter of the trunk 4 ft., and of the head 47 ft. In Pembrokeshire, at Stackpole Court, 30 years planted, it is 40 ft. high. In Shropshire, at Hardwick Grange, 10 years planted, it is 39 ft. high; at Willey Park, 18 years planted, it is 49 ft. high; and 9 years planted, it is 45 ft. high. In Staffordshire, at Trentham, it is 100 ft. high, the diameter of the trunk 3 ft. 6 in., and of the head 32 ft. In Suffolk, in the Bury Botanic Garden, 10 years planted, it is 40 ft. high; at Finborough Hall, 14 years planted, it is 30 ft. high. In Worcestershire, at Hagley, are several with trunks 4 ft. in diameter; at Hadsor House, 10 years planted, it is 26 ft. high; at Croome, 50 years planted, it is 95 ft. high. In Yorkshire, at Hackness, 20 years planted, it is 42 ft. high; at Grimstone, 13 years planted, it is 56 ft. high; at Studley, 112 ft. high, diameter of the trunk 4 ft., and of the head 60 ft.—In Scotland, in the Experimental Garden, Edinburgh, 10 years planted, it is 19 ft. high; at Cra-mond House, it is 70 ft. high, the diameter of the trunk 3 ft. 6 in., and of the head 50 ft.; at Hopetoun House, it is 75 ft. high, the diameter of the trunk 3 ft. 6 in., and of the head 48 ft. In Ayrshire, at Doonholm, 70 years old, it is 85 ft. high; at Doonside, 60 years old, it is 80 ft. high, with a trunk 3 ft. 6 in. in diameter. In Roxburghshire, at Minto, 100 years old, it is 90 ft. high, with a trunk 4 ft. in diameter. In Banffshire, at Cullen House, 90 years old, it is 85 ft. high. In Perthshire, at Glenegles, many pine trees from 80 ft. to upwards of 90 ft. high; at Taymouth, 70 years old, it is 96 ft. high, the diameter of the trunk 4 ft. 8 in.; and another is 120 ft. high. In Ross-shire, at Brahan Castle, it is 80 ft. high. In Sutherlandshire, at Dunrobin Castle, it is 86 ft. high. In Stirlingshire, at Blair Drummond, 100 years old, it is 105 ft. high; at Airthrey Castle, it is 100 ft. high; and at Tullibody, 85 ft. high.—In Ireland, in Tyrone, at Baron's Court, it is 94 ft. high.—In France, at Nantes, in the nursery of M. Nérières, 40 years planted, it is 50 ft. high.—In Saxony, at Wörlitz, 60 years old, it is 80 ft. high.—In Austria, at Brück on the Leytha, 50 years old, it is 70 ft. high.

Commercial Statistics. Price of seeds, in London, 3s. per lb.: of one year's seedling plants, 1s. 6d. per thousand; of two years' seedlings, 2s. 6d. per thousand: transplanted plants, from 1 ft. to 2 ft. high, 10s. per thousand; from 2 ft. to 3 ft. high, 25s. per thousand: plants raised from Tyrolese or Vallais seeds, one year transplanted, 5s. per hundred. At Bollwyller, two years' seedlings, 2 ft. high, are 10 francs per hundred. At New York, plants are 50 cents each.

‡ 2. *L. AMERICANA Michx.* The American Larch.

Identification. Michx. N. Amer. Syl. 3. p. 213.

Synonymes. *Pinus taricina Du Roi Harb.*, ed. Pott., 2. p. 117.; *P. microcarpa Willd. Baum.*, p. 275., *Lamb. Pin.*, ed. 2., t. 50.; *Abies microcarpa Poir.*; Hackmatack, *Amer.*; Tamarack by the Dutch in New Jersey; *Epinette rouge* in Canada.

Engravings. Michx. N. Amer. Syl., 3 t. 153.; Lamb. Pin., ed. 2., t. 50.; and the plate of this tree in our last Volume.

Spec. Char., &c. Leaves short. Cones small, ovate-roundish, with few scales. (*Michaux.*) Leaves from $\frac{1}{2}$ in. to $\frac{3}{4}$ in. long. Cones from $\frac{1}{2}$ in. to $\frac{3}{4}$ in. long, and from $\frac{3}{8}$ in. to $\frac{1}{2}$ in. broad. A tree, with a slender trunk, and attaining, in America, as great a height as the European larch does in Europe. Introduced in 1739, and flowering in May. None of the varieties of this species can be at all compared with the European larch, in point of utility, or even ornament.

Varieties.

‡ *L. a. 1 rubra*; *L. microcarpa* *Laws. Man.*, p. 388.; *Pinus microcarpa Pursh Fl. Amer., Sept.*, p. 645., *Lodd. Cat.*; *E'pinette rouge, Canada.* The small red-coned American Larch. — The following characters of this variety are given in Lawson's *Manual*: — "Tree, medium-sized, upright, of a slender, conical, or pyramidal habit of growth, but not so much so as in *L. a. pendula*. Branches horizontal, or slightly pendulous, except the upper, which are rather aspiring; branchlets also pendulous, and, together with the branches, more numerous and dense than those of *L. a. pendula*. Bark smoothish, of a brownish grey, and light brown on the young twigs. Leaves of a vivid grassy green, and shorter and narrower than those of *L. europæa*. Catkins very similar to those of the *L. a. pendula*; but the bractæ of the female or young cones are of a more regular oval shape. Ripe cones about $\frac{1}{2}$ in. in length, easily detached from the branches, of an oblong shape; scales also somewhat oblong or oval, light brown, slightly incurved, and rougher, or more distinctly striated, than those of the black larch. Seeds also shorter, or more rounded, and, together with the alæ, of a lighter brown." A native of North America. Introduced in 1760, and flowering in April. (*Laws. Man.*, p. 388.) There are trees of this variety in the Duke of Athol's plantations, which, in 1820, were 50 years old, and did not contain a third part of the timber of the common larch of the same age. The wood, however, is so ponderous, that it will scarcely swim in water.

‡ *L. a. 2 pendula*; *L. pendula* *Laws. Man.*, p. 387.; *Pinus pendula Ait. Hort. Kew.*, ed. 1., iii. p. 369., *Pursh Fl. Amer. Sept.*, ii. p. 645., *Willd. Baumz.*, p. 215., *Lamb. Pin.*, ed. 2., t. 40.; *P. intermedia Du Roi Harbk.*, ii. p. 115., *Wang. Beit.*, p. 42., *Lodd. Cat.*, ed. 1836.; *P. Lâ-rix nigra Marsh. Arb. Amer.*, p. 203.; *A'bies pendula Poir. Dict.*, p. 514., *N. Du Ham.*, v. p. 288.; Tamarack, *Amer.* The black pendulous-branched American Larch. — According to Lawson, this is a "tree of medium size, slender, and generally bending towards the top. Branches verticillate, few, remote, and pendulous; branchlets also thin, and more pendulous than the branches. Bark smooth, and very dark-coloured; that on the youngest twigs of a dark purplish colour, inclining to grey. Leaves like those of the common larch in shape, but rather longer, darker in colour, and arising from shorter and much darker-coloured buds or sheaths. Male and female catkins small and short; the latter generally tinged with reddish purple. Cones, when ripe, easily detached from the branches, generally under $\frac{1}{2}$ in. in length; scales round, or slightly approaching to an oval shape, smoothish, of a dark brown colour, few, loose, and slightly incurved on the margins; bractæ much shorter than the scales, of a somewhat lyrate shape; waved on the margins, and tipped with a short, soft, acute point. Seed considerably smaller than that of *L. europæa*, and of an oblong shape; alæ, or wings, of a brownish-purple colour. Native of North America. Introduced into Britain in 1739. The *L. a. pendula* grows only in the colder parts of North America, being entirely confined to the northward of 40° of latitude; and is found in greatest abundance in mountainous parts, on rather moist and inferior soils. The timber of *L. a. pendula* is of a darkish brown colour, waved, very tough, durable, and, where it is plentiful, preferred, for general pur-

poses, to any of the American pines or firs which grow in the same parts." (*Laws. Manual*, p. 388.) Mr. Blair, when in Canada, was informed that the wood of this tree is preferred to maple, hickory, or beech, as fuel for the steam-boats on the St. Lawrence. (*Blair in Gard. Mag.*, vol. viii. p. 488.) In Mr. M'Nab's article on the local distribution of different species of trees in the native forests of America, published in the *Quarterly Journal of Agriculture*, he states that on a flattened, low, moist meadow, on this line of road, was an extensive forest of the tamarack, or black American larch, which he calls *Làrix pëndula*, tall straggling trees, with stems not exceeding 1 ft. 8 in. in circumference. "Through the tract of country which we have passed," he adds, "this tree was by no means plentiful, having only seen four masses of them, and these very distant from each other: all were in similar situations." (*Quart. Journ. of Agr.*, vol. v. p. 601.)

- ‡ *L. a. 3 prolifera*; *L. prolifera Malcolm*. *The proliferous-branched Larch*.— In this variety, the axis of the cones is prolonged in the form of a shoot; a kind of monstrosity which is found in all the varieties of *L. americana*, and also occasionally, as Richard has shown, in some species of *Abies* and *Picea*. The plant in the Horticultural Society's Garden, after being 12 years planted, is 15 ft. high.

Description, &c. Michaux describes the American larch as a tall slender tree, with a trunk 80 ft. or 100 ft. high, and only 2 ft. or 3 ft. in diameter. Its numerous branches, except near the summit, are horizontal or declining. The bark is smooth and shining on the trunk and larger branches, but rugged on the smaller branches. The leaves are flexible, and shorter than those of the European species. The cones are small and erect; green in spring, and generally brown when ripe, but sometimes they are found of a violet colour. The wood, Michaux says, is equal to that of the European larch, being exceedingly strong, and singularly durable. The American larch is most abundant in Vermont, New Hampshire, and the district of Maine; but, though the soil is well adapted to its growth, it does not form the hundredth part of the *Abietinæ* in these latitudes. According to the elder Michaux's observations, in his journey to Hudson's Bay, it is only beyond the St. Lawrence, particularly near Lake St. John, and the Great and the Little Lake Misstassin, that it begins to abound, and to form masses of wood, some of which are several miles in extent. It is abundant in Newfoundland, in nearly the same latitude. New Jersey, Pennsylvania, and the coldest and gloomiest exposures in the mountainous tracts of Virginia, are the limits of its appearance towards the south; but it is rare in these states: and, in Lower Jersey and the vicinity of New York, it is seen only in the swamps of white cedar (*Cupressus thuyoides*), with which it is scantily mingled. According to Pursh, the two forms of this species, though united in one by Michaux, are specifically and constantly different. He never saw them both growing in the same place, or even near one another. *L. a. pëndula* was introduced by Peter Collinson, in 1739; and the original tree planted by him at Peckham was afterwards removed to Mill Hill; where it was cut down, says Sir James Edward Smith, "about the year 1800, to make a rail, by its sapient possessor. The abundance of seeds," he adds, "which it annually produced might have been a far more lasting source of profit, as few exotic trees are more worthy of cultivation. It was from this tree that Solander first described *L. a. pëndula* as a distinct species, *L. a. rubra* not having been introduced till 1760. The original tree of this latter variety was planted by John Duke of Argyll at Whitton, where Sir James Edward Smith and Mr. Lambert saw it early in the present century, and where we examined it on the 21st of July, 1837, and found it between 40 ft. and 50 ft. high. The wood, in America, and especially in Canada, according to Michaux, is considered among the most valuable timber, and has no fault except its weight. In the district of Maine, it is more esteemed than any other resinous wood,

for the knees of vessels; and Michaux thinks that it would be much more employed in America than it is, if it were not comparatively rare there. In Britain, it can only be considered as a curious or ornamental tree. Seeds are sometimes ripened in this country, and are also sometimes imported; in consequence of which, both varieties are not uncommon in the nurseries.

Statistics. *Larix americana sæbra*. In the environs of London. At Syon, it is 67 ft. high, the diameter of the trunk 1 ft. 3 in., and of the head 35 ft. This tree is figured in our last Volume. — South of London. In Surrey, at Farnham Castle, 35 years planted, it is 20 ft. high, the diameter of the trunk 1 ft. 8 in.; at Bagshot Park, 16 years planted, it is 25 ft. high; at Claremont, it is 70 ft. high, the diameter of the trunk 1 ft. 6 in., and of the head 40 ft. In the Isle of Jersey, in Saunders's Nursery, 10 years planted, it is 24 ft. high. — North of London. In Bedfordshire, at Southill, it is 65 ft. high, the diameter of the trunk 2 ft. 6 in., and of the head 65 ft. In Warwickshire, at Combe Abbey, 60 years planted, it is 84 ft. high, diameter of the trunk 3 ft., and of the head 42 ft. In Worcestershire, at Croome, 40 years planted, it is 90 ft. high, the diameter of the trunk 1 ft. 6 in., and of the head 20 ft. — In Scotland, in the environs of Edinburgh, at Dalhousie Castle, 15 years planted, it is 19 ft. high. — In Ireland, in the Glasnevin Botanic Garden, 20 years old, it is 16 ft. high. At Cypress Grove, near Dublin, it is 40 ft. high. In King's County, at Charleville Forest, 45 years planted, it is 94 ft. high.

Larix americana pendula. In England. In Berkshire, at White Knights, 36 years planted, it is 48 ft. high. In Staffordshire, at Trentham, 25 years planted, it is 40 ft. high, the diameter of the trunk 1 ft. 4 in., and of the head 25 ft. In Worcester, at Croome, 35 years planted, it is 40 ft. high. — In Scotland, in the Experimental Garden, Edinburgh, 6 years planted, it is 12 ft. high. — In Ireland. At Terenure, near Dublin, 15 years planted, it is 10 ft. high. In Louth, at Oriel Temple, 55 years planted, it is 52 ft. high.

Commercial Statistics. Price of seeds, in London, 2s. 6d. per oz.; of plants, 10s. per 100. At Bollwyller, plants are 2 francs each; and at New York, 75 cents.

GENUS V.



CEDRUS *Barrel.* THE CEDAR. *Lin. Syst. Monœ'cia Monadélphia.*

Identification. Barrelier Plante per Galliam, &c., observata, &c., Ic., 499.

Synonymes. Pinus *Lin.*, in part; *Abies Poir.*, in part; *Larix Toura.*, in part; Cèdre, *Fr.*; Cedar, *Ger.*

Derivation. Some suppose the word Cedrus to be derived from *Cedron*, a brook in Judea, on the banks of which the cedar of Lebanon was once plentiful: others (see *M. Thés. Gloss. Bot.*, p. 368.), from *kaß*, I burn; from the wood of some of the kinds of cedar being burned as incense: and others, from the Arabic *kedroum*, or *kèdre*, power. (See *Gottus Lexicon Arab.*, col. 1861.)

Description. Majestic evergreen trees; natives of Asia and Africa, with large spreading branches. Extremely ornamental, and one species producing excellent timber.

† 1. *C. LIBA'NI Barr.* The Cedar of Lebanon.

Identification. Barrel. Ic., 499; Edw. Ornith., t. 188; Lawson's Manual, p. 390; Bon Jardinier, ed. 1837, p. 981.

Synonymes. Pinus *Cedrus Lin. Sp. Pl.*, 1460, *Syst.*, ed. Reich., 4 p. 174., *Smith* in *Rees's Cyclop. Hist. Evol. Syst.*, p. 311., *Alt. Hort. Kew.*, 3. p. 369., *Vism. Sp. Pl.*, 5 p. 345., *Willd. Berol. Baumz.*, p. 214.; *P. foliis fasciculatis*, &c., *Du Roi Herb.*, ed. Pott., 2. p. 190.; *Larix Cedrus Müll. Dict.*, No. 3.; *Larix orientalis Toura. Ins.*, p. 568., *Du Ham. Arb.*, 1. p. 332.; *Cedrus magna Dod. Pempt.*, 867.; *C. conferta Bauh. Pin.*, p. 490., *Reid Hist.*, p. 1404.; *C. phœnicum Renealm. Sp.*, p. 47.; *Cedrus Bell. It.*, p. 162., *Cam. Epit.*, p. 57.; *Abies Cedrus Poir. Dict. Encyc.*, 6 p. 510., *N. Du Ham.*, 5. p. 287., *Lindl.* in *Penn. Cyc.*

Engravings. Du Ham. Arb., 1. t. 132; Trew Ehret, t. 1. 4. 28. 60, and 61.; Nov. Act. A. N. C., 5. App. t. 13. f. 1. 7, 11, 12., and 14.; Barrel. Ic., t. 499; Edw. Ornith., t. 188.; Lamb. Pin., ed. 2. t. 51.; our *Ag.* 2267.; and the plates of this tree in our last Volume.

Spec. Char., &c. Leaves tufted, perennial. Cones ovate, abrupt; their scales close-pressed. Crest of the anthers ovate, flat, erect. (*Smith.*) Cones ovate, from 3 in. to 5 in. long, and from 2 in. to 2½ in. broad. Seeds of an irregular triangular form; nearly ½ in. long, with a very broad membranaceous wing. Cotyledons 6. A tree, a native of Syria, on Mount Lebanon; and of the north of Africa, on Mount Atlas. Introduced before 1683.

Varieties.

‡ *C. L. 2 foliis argenteis* has the leaves of a silvery hue both above and below. There are very large trees of this variety at Whitton and Pain's Hill, and a dwarf bushy one, remarkable for its silvery aspect, at the Countess of Shaftesbury's villa (formerly the residence of

Thomson the poet), on the banks of the Thames at Richmond, of which there is a portrait in our last Volume. It is singular that the nurserymen have never taken the trouble to raise plants from the seeds, or from scions, of this very beautiful variety.

- ‡ *C. L. 3 nana* is a very dwarf variety, of which we have only seen one plant at Hendon Rectory, Middlesex, which, 10 or 12 years old, is only from 2 ft. to 3 ft. high, making shoots from 2 in. to 3 in. in a year.

Other Varieties. At Pepper Harrow, in Surrey, the seat of Lord Viscount Middleton, there are a great many cedar trees, some of which are quite fastigate in their habit of growth, resembling immense cypresses; while others have the branches depressed at their insertion in the trunk, and their extremities pendulous like those of the hemlock spruce. Some are dwarf and bushy, and others very tall, with comparatively few branches; the leaves of some are dark green, while those of others are quite glaucous. The cones are of very different sizes. These variations arise, no doubt, simply from the tendency of the cedar to sport when raised from seed; as similar variations are always found, more or less, wherever the cedar has been planted in considerable quantities. In the Garden Lemonnier, at Versailles, is a cedar about 20 ft. high, with a trunk 2 ft. in circumference at the base. It is apparently very old, and has a knotty stunted appearance, like the gnarled branches of an aged oak. It has never produced seeds (*Ann. d'Hort.*, xvi. p. 337), and is most probably only a variation.

Description. A widely spreading tree, generally from 50 ft. to 80 ft. high; and, when standing singly, covering a space with its branches, the diameter of which is often much greater than its height. The leading shoot, in young trees, generally inclines to one side, but it becomes erect, as the tree increases

in height. It is covered with a brownish bark, which becomes cracked as the tree advances in age. The horizontal branches, or limbs, when the tree is exposed on every side, are very large in proportion to the trunk: they are disposed in distinct layers, or stages, and the distance to which they extend diminishes as they approach the top; thus forming a pyramidal head, broad in proportion to its height. The extremities of the lower branches, in such trees, generally rest on the ground, bent down by their own weight; but they do not root into it.

The summit, in young trees, is spiry; but in old trees it becomes broad and flattened. When the cedar of Lebanon is drawn up among other trees, it produces a clean straight trunk, differing only in appearance from that of the larch in the colour of its bark; but having been long considered more as an ornamental than a useful tree, it is seldom found planted in masses, or intermixed with other trees in plantations. If a branch of the cedar is cut off, it is stated in Lambert's *Pinus*, that "the part remaining in the trunk gradually loosens itself, and assumes a round form resembling a potato; and, if the bark covering it be struck smartly with a hammer, the knot leaps out." This fact, Mr. Lambert states, was communicated to him by Sir Joseph Banks; but he adds that he had tried the experiment himself. The branchlets are disposed in a flat fan-like manner on the branches; and, as they are numerous and thickly set with leaves, single detached trees appear, at a little distance, a dense mass of foliage. The leaves are straight, about 1 in. long, slender, nearly cylindrical, tapering to a point, and are on short footstalks: they are generally of a dark grass green; but, in the variety called the silver cedar, they have a beautiful glaucous hue. The leaves, which remain two years on the branches, are at



2267

first produced in tufts; the buds from which they spring having the appearance of abortive shoots, which, instead of becoming branches, only produce a tuft of leaves pressed closely together in a kind of whorl.

These buds continue, for several years in succession, to produce every spring a new tuft of leaves, placed above those of the preceding year; and thus each bud may be said to make a slight growth annually, but so slowly, that it can scarcely be perceived to have advanced a line in length; hence, many of these buds may be found on old trees, which have eight or ten rings, each ring being the growth

of one year; and sometimes they ramify a little. At length, sooner or later they produce the male and female flowers. The male catkins are simple, solitary, of a reddish hue, about 2 in. long, terminal, and turning upwards. They are composed of a great number of sessile, imbricated stamens, on a common axis. Each stamen is furnished with an anther with 2 cells, which open lengthwise by their lower part; and each terminates in a sort of crest pointing upwards. The pollen is yellowish, and is produced in great abundance. The female catkins are short, erect, roundish, and rather oval: they change, after fecundation, into ovate-oblong cones, which, when they approach maturity, become from $2\frac{1}{2}$ in. to 5 in. long. The cones are of a greyish brown, with a plum-coloured or pinkish bloom when young, which they lose as they approach maturity: they are composed of a series of coriaceous imbricated scales, laid flat, and firmly pressed against each other in an oblique spiral direction. The scales are very broad, obtuse, and truncated at the summit; very thin, and slightly denticulated at the edge; and reddish and shining on the flat part. Each scale contains 2 seeds, each surmounted by a very thin membranaceous wing, of which the upper part is very broad, and the lower narrow, enveloping the greater part of the seed. The cones are very firmly attached to the branches: they neither open nor fall off as in the other *Abiétinæ*; but, when ripe, the scales become loose, and drop gradually, leaving the axis of the cone still fixed on the branch. The seeds are of an irregular, but somewhat triangular, form, nearly $1\frac{1}{2}$ in. long, of a lightish brown colour. Every part of the cone abounds with resin, which sometimes exudes from between the scales. The female catkins are produced in October, but the cones do not appear till the end of the second year; and, if not gathered, they will remain attached to the tree for several years.

The tree does not begin to produce cones till it is 25 or 30 years old; and, even then, the seeds in such cones are generally imperfect, and it is not till after several years of bearing, that seeds from the cones of young trees can be depended on. Some cedars produce only male catkins, and these in immense abundance; others only female catkins; and some both. There are trees at Whitton, Pepper Harrow, and other places, which, though upwards of 100 years old, and of vigorous growth, have scarcely ever produced either male or female catkins. The duration of the cedar is supposed to extend to several centuries.



The Syon Cedar.



The Enfield Cedar.

The rate of growth of the cedar is generally considered slow; but, under favourable circumstances, it is at least as rapid as that of other resinous trees. Loiseleur Deslongchamps, in his very able article on the cedar in the *Nouveau Du Hamel*, compares the rate of growth of the tree in England and France, by showing the increase in a given number of years of the trees at Chelsea, and of that in the Jardin des Plantes. The trees in the Chelsea Garden were planted in 1683, being then 3 ft. high; and, in 1766, two of them were upwards of 12 ft. 6 in. in girt at 2 ft. from the ground, and their branches extended more than 20 ft. on every side; which branches, Miller adds, "though they were produced 12 ft. or 14 ft. above the surface, did, at every termination, hang very near the ground, and thereby afford a goodly shade in the hottest season of the year." The cedar in the Jardin des Plantes measured, in 1786, at the ground, 4 ft. 6 in. French (about 5 ft. English) in circumference; in 1802, according to M. Dutour (*Nouv. Dict. d'Hist. Nat.*, iv. p. 449.), it was 7 ft. 10 in. (nearly 8 ft. 6 in.); and in 1812, when it was 78 years old, it was 8 ft. 8 in. (9 ft. 4½ in.) In 1834, according to the Return Paper we received from M. Mirbel, the same tree, then exactly 100 years old, was 10 ft. 6 in. (11 ft. 4 in.) in circumference; and the largest of the Chelsea cedars, in the same year, was nearly 15 ft. in circumference, they being upwards of 150 years old. The rapid growth of the Chelsea cedars during the first 83 years is accounted for by the circumstance of their standing near a pond, into which their roots extended; and, when this pond was filled up (which it was a few years after 1766, when Miller measured them), their growth was instantly checked; and so much so, that, in 1793, when measured by Sir Joseph Banks, the largest was only 12 ft. 11½ in. in circumference, having increased only 5½ in. in 30 years. The cedar in the Jardin des Plantes, though the most celebrated, is not the largest in France: another plant, brought from England by Jussieu at the same time, and planted in the garden of the Château de Montigny, had a trunk, in 1832, when measured by M. Murat, nearly 17 ft. French (18 ft. 5 in. English) in circumference at 4 ft. from the ground. It had lost its leading shoot, and was only a little higher than the tree in the Jardin des Plantes.

The two largest cedars at Whitton, which, in 1837, were 105 years old from the seed (see p. 57.), were upwards of 70 ft. high, with trunks 14 ft. 6 in. in circumference at 2 ft. from the ground. The pinaster, Scotch pine, silver fir, and larch, at Whitton, in the same soil and situation, had not made nearly so much timber; though it is proper to state that these last kinds had rather less room than the cedars. One of the largest of these cedars was blown down in the violent storm of wind in November, 1836. The lower part of the trunk, after being squared, measured nearly 4 ft. on the side; and the annual growths were so large, that 20 of them measured across 6½ in. The largest of these annual layers was no less than ½ in., and the smallest exceeded ¼ in. A plank of this



The Chelsea Cedars.



The Croome Cedar

most remarkable tree was kindly presented to us by the proprietor, J. Gosling, Esq.; on a portion of which we made several experiments, which proved it to be very inferior in point of strength to the common English-grown Scotch pine, and the remainder we have had made into a table. The colour and the grain of the wood are precisely the same as those of a specimen accompanied by cones and leaves received by Mr. Lambert from Morocco. At St. Ann's Hill is a cedar planted by the Honourable Mrs. Fox, in 1794, which, in 1834, was 50 ft. high, diameter of the trunk 3 ft. 6 in., and of the head 72 ft. At Redleaf, near Penshurst, there are cedars which, in 1837, were 36 ft. high, and girted 4 ft. 6 in. at 3 ft. from the ground. These were raised from seeds exactly 20 years before, by the proprietor, W. Wells, Esq., who purchased the cone from which the seeds were taken in a London seed-shop in 1816. Another cedar at Redleaf, after being planted 27 years, when under 3 ft. high, is 52 ft. high, and 5 ft. 6 in. in circumference at 3 ft. from the ground. In Scotland and Ireland, in sheltered situations, and on good soil, the growth of the cedar is found to be nearly as rapid as that of the larch. When the leading shoot of the cedar is broken, it does not form another, and ceases to grow in height. The cedar in the Jardin des Plantes, which lost its leader at the commencement of the French revolution, has not increased in height since; but its branches have extended 45 ft. French (nearly 50 ft. English) on each side, giving a diameter to the head of nearly 100 ft.

The most remarkable cedars in point of age, near London, are those in the Chelsea Botanic Garden, now in a state of rapid decay; and of which *fig. 2270.* is a portrait to the scale of 1 in. to 50 ft. There was till lately a fine old tree at Hammersmith, in the garden of a house which was formerly occupied by Bishop Atterbury, of which *fig. 2272.* is a portrait from an engraving by Strutt. There is a very old cedar at Enfield (*fig. 2269.*), by some supposed to be older than the Chelsea cedars.

At Croomer, in Worcestershire, there is a cedar remarkable for its magnitude, and the nakedness of its branches, of which *fig. 2271.* is a portrait reduced from a drawing kindly made for us by Miss Radcliffe of Worcester. The tallest cedar in the neighbourhood of London is one at Kenwood, figured in our last Volume, which is 95 ft. high; and the handsomest is one at Syon, also figured in our last Volume, and of which *fig. 2268.* is a portrait reduced to the same scale as the other figures of cedars here given. In Scotland, the largest cedars are at Hopetoun House, and in Dalkeith Park; and there is a very handsome one, comparatively young, on the estate of Gray, in Forfarshire, of which *fig. 2273.* is a portrait, reduced from a drawing sent to us by Mr. Robertson, gardener to Earl Gray, at Kinfauns Castle. The largest cedars in Ireland are believed to be those at Castletown, the seat of Colonel Conolly; or at Mount Anville, the seat of Counsellor West.

Geography. The cedar of Lebanon is generally supposed to grow nowhere but on that mountain; but it was discovered, in 1832, on several mountains of the same group, by N. Bové, ex-director of agriculture of Ibrahim Pacha, at Cairo. In passing from Sakhléhé to Der-el-Khamer, on the afternoon of October 11., M. Bové passed through a valley, the right side of which was bounded by a mountain, and on its summit some thousands of cedars of Lebanon were growing, covered with catkins. "These

2272



The Hammersmith Cedar.

2273



The Gray Cedar.

trees," he says, "are from 3 ft. to 16 ft. French, in circumference, and their height exceeds 50 ft. French. I suppose," he adds, "that they owe their preservation to their being situated on a mountain difficult of access, and at a distance from towns where their wood could be used, and to which from their present habitat, it could now be only transported on the backs of animals." (*Ann. Scien. Nat.*, 2. s., vol. i. p. 235.) The cedar has also been lately discovered on Mount Atlas, whence cones, and specimens of the branches, leaves, and wood, have been sent by Mr. Drummond Hay, the British consul at Tangier, to Mr. Lambert; and specimens have also been received from Morocco by P. B. Webb, Esq. The probability is, that the range of the tree not only extends over the whole of that group of mountains which is situated between Damascus and Tripoli in Syria, and which includes the Libanus and Mounts Amanus and Taurus of antiquity, and various other mountains, but that its distribution on the mountainous regions of the north of Africa is extensive; though of the botany of these latter regions scarcely anything is at present known. The ancient writers who mention the cedar state that it had many different habitats; and Theophrastus and Pliny make it a native of Egypt, Crete, Cyprus, &c.; but, as they included the junipers, and probably several other trees, under the general name of Cedrus, no reliance can be placed on their testimony. The cedar has been said by some authors, both Continental and British, to be a native of Mounts Amanus and Taurus, and of Siberia; but, though the first statement is probably true, the second, as will hereafter be shown, is decidedly erroneous. Loiseleur DeLongchamps in the *Nouveau Du Hamel*, and Baudrillart in the *Dictionnaire des Eaux et Forêts*, inform us that Belon found the cedar growing on Mount Amanus and Mount Taurus; and that Pallas states, in his *Observations faites dans un Voyage*, &c., that he found it in the countries between the Wolga and the Tobol, in Siberia, and on the Altaic Mountains, Baudrillart adding that he had been informed by a Russian officer in the administration of the forests, that the wood of the cedars found in Siberia was so soft and so brittle, as to be unfit for the construction of ships. Mr. Lambert also quotes Pallas, to prove that the cedar, in Siberia, does not thrive so well in dry as in moist ground.

Belon, who wrote about 1550, mentions the cedar among the "singularities" observed by him during his travels in the East (see *Les Observ.*, &c., p. 162. 166.); and states that it grows not only on Mount Libanus, "on which some remain even to this day, planted, as it is thought, by Solomon himself;" but also "on the mountains Taurus and Amanus, in cold stony places." He adds that the merchants of the factory of Tripoli, in Syria, told him that "the cedar grew on the declivity of Mount Lebanon next that city, and that the inhabitants of Syria made boats of it, for want of the pine tree." In Belon's treatise, *De Arboribus Coniferis*, published in 1553, the author says he was told that the cedar of Solomon is found on Mount Lebanon, and also on Amanus and Taurus, and on the mountains above Nicea; but nowhere in the Isle of Crete. He then mentions several kinds of juniper, all of which he calls cedars; and states it to be his opinion, that the great cedar of Mount Lebanon was not the wood used for building Solomon's temple. (p. iv.) In another page, after relating his visit to Mount Lebanon, he says, "Right true and excellent are the trees of Mount Lebanon." He afterwards describes their appearance and mode of growth, adding: "The cedars that we saw on Amanus and Taurus were very similar to these. They grow in moist places, like those in which the spruce fir (*picea*, *Abies L.*) delights; and they are also found in moist valleys:—*Cedros* quas in Amano et Tauro vidimus, eandem cum prædictis habere similitudinem comperimus. In humidis nati quemadmodum *picea*, oblectatur, atque etiam convalles humorem habentes sequi." He adds that these trees grow somewhat like the silver fir (*abies*, *Picea L.*), but have a portion of the trunk smooth (*glabro*), and unclothed. It is very probable, the trees found by Belon on Mounts Amanus and Taurus were not cedars of Lebanon, but the *Pinus Cembra*. With regard to the assertion, that Pallas found the cedar in Siberia, M. Delamarre, in his

Traité pratique de la Culture des Pins, p. 315., observes:—"There appears to be an error in the statement that Pallas found the cedar in Siberia, and on the Altaic Mountains. M. Ferry, a literary man, who resided three years in Siberia, has published a paper in the *Bibliothèque Physico-Économique*, in which he proves that the tree called by the French translator of Pallas's *Travels* the cedar, was, in fact, *Pinus Cembra*; the Russian name for which is *kedr*. He adds, in confirmation of this, that Pallas, in his *Flora Rossica*, does not mention the cedar of Lebanon, though he speaks fully of *P. Cembra* (*Fl. Ross.*, p. 4.); stating that he found it both in forests by itself, and intermixed with other trees; and that it preferred cold moist places to dry ground. M. Ferry adds that Pallas, in his *Travels*, invariably calls the trees he mentions by their popular names in their native countries; and that the French translator, meeting with the word *kedr* in the German work, fancied that it must mean cedar, and translated it accordingly." M. Loiseleur Deslongchamps has also noticed this error in an article entitled *Histoire du Cèdre du Liban*, published in the *Annales de l'Agric. Franç.*, for 1837, a copy of which we have received since this sheet was in type.

History. The first account we have of the cedar of Lebanon is that contained in the *Bible*, where we are told that Moses commanded the lepers among the Israelites to make an offering of two sparrows, cedar wood, scarlet (that is a lock of wool twice dyed), and hyssop. (*Levit.*, xiv. 4. 6.) The houses in which lepers had dwelt were purified in the same manner. (*Ibid.*, 49, 51, and 53.) When Moses and Aaron were ordered to sacrifice a red heifer (*Numbers*, xiv. 6.), they were also commanded to throw cedar wood, hyssop, and scarlet into the midst of the burning sacrifice; the ashes of which were gathered up to serve as a purification from sin. When Solomon rebuilt the temple of Jerusalem, he obtained permission from Hiram, king of Tyre, to cut down the cedar and fir necessary from Mount Lebanon; and for this purpose he sent fourscore thousand hewers to cut down the trees. There was also a palace built by Solomon, which was called the House of the Forest of Lebanon, from the great quantity of cedar used in its construction. Solomon is stated to have paid to Hiram twenty thousand measures of wheat, and twenty measures of pure oil, annually, while the work was in progress; and, when it was completed, he ceded to him twenty villages in Galilee. In the Psalms, there are frequent allusions to the cedar:—"The righteous shall flourish like the palm tree: he shall grow like a cedar in Lebanon." "The hills were covered with its shadow, and the boughs thereof were like goodly cedars," &c. In the Book of Ezekiel is the following striking passage:—"Behold, the Assyrian was a cedar in Lebanon, with a shadowing shroud of a high stature; and his top was among thick boughs. The waters made him great; the deep set him up on high with her rivers running round about his plants, and sent out her little rivers unto all the trees of the field, therefore his height was exalted above all the trees of the field, and his boughs were multiplied; and his branches became long, because of the multitude of the waters which he shot forth. All the fowls of heaven made their nests in his boughs, and under his branches did all the beasts of the field bring forth their young, and under his shadow dwelt all great nations." (*Ezekiel*, xxxi. 3, 4, 5, and 6.) Many other passages might be quoted, but these will suffice to show the very frequent allusions to the tree in Holy Writ. Some persons, however, suppose that the cedar of the *Bible* is not that of Mount Lebanon; as the wood of the latter, though slightly fragrant, is not durable, and the tree cannot be called very lofty. It is possible that the wood of old trees, growing in their native habitat, may be much harder, of finer grain, and consequently less liable to corrupt, than the timber of young trees grown rapidly in this country; and, though there is no tree now existing on Mount Lebanon, or elsewhere, of very lofty stature, the terms employed probably alluded rather to the grandeur and magnificence of the tree, than to its actual height. Some writers have supposed that the cedar of the *Bible* was a kind of juniper; others that it was the *Cedrus Deodara*; and some, that it might be the *Thuja articulata*; but the expression of the Psalmist, when, in allusion to the flourishing state of a people, he says, "they shall spread their branches like the cedar," seems clearly to allude to the cedar of Lebanon.

In profane history, many writers mention the usefulness and durability of the cedar. Diodorus Siculus tells us that Sesotris the Great, king of Egypt, built a vessel of cedar, 220 cubits long, which was covered with gold both within and without. (*Lib. l. § 2.*) Theophrastus and Pliny say that the Egyptians used the cedar instead of the pine, which did not grow in their country (*Theophr.*, lib. v. cap. 8.; *Plin.*, lib. xvi. cap. 40.); and they are said to have used the extract of cedar, mixed with other drugs, to preserve their mummies. The largest cedar recorded in ancient history is one which was employed to make a galley for King Demetrius, which had eleven ranks of oars; but this tree, as it grew in the Isle of Cyprus, was probably the evergreen cypress; its length was 130 ft., and its thickness 18 ft. The Emperor Caligula had constructed of the wood of the cedar what he called Liburnian ships, of which the poops were enriched with precious stones, and the sails were of different colours; and which contained baths, and dining-rooms decorated with painting and carving. (*Suet. in Caligula*, cap. xxxvii.; *Plin.*, lib. xiii. cap. 5.) The ancients considered the cedar as an incorruptible kind of wood, which would last for ever; and for this reason they made with it their temples, and the statues of their gods and kings. Virgil says,—

"Quin etiam veterum edifies ex ordine avorum
Antiqua e cedro."

Æneid. vii. 177.

"Before the gates, a venerable band,
In cedar carved, the Latian monarchs stand."

Pitt's trans.

According to Vitruvius (*lib. iii. cap. 9.*), the leaves of the papyrus, and other objects, were rubbed with the resin of the cedar, an oil, or juice, which he calls *cedria*, in order to preserve them from the worms; as, according to Pliny and others, it did the Egyptian mummies. (*Plin.*, lib. xvi. cap. 11.; *Diod. Sic.*, lib. i. § 2.) Vitruvius also mentions the Juniperus *Oxycedrus*, but clearly distinguishes it from the great cedar, which is supposed to be the cedar of Lebanon. The celebrated temple of Diana at Ephesus, which was accounted one of the seven wonders of the world, which took 220 years in building, and which was burned down to the ground the night Alexander the Great was born, was principally constructed of cedar. Pliny tells us of a temple of Apollo at Utica (the well-known city of that name in Africa), in which was found cedar timber that, though nearly 2000 years old, was perfectly sound. At Saguntum, in Spain, continues Pliny, was a temple consecrated to Diana, which was built 200 years before the destruction of Troy; and it contained a statue

of the goddess formed of cedar, which had been formerly taken from the Island of Zacynthus (now called Zante) by the inhabitants, when they formed the colony of Saguntum. When the inhabitants of the city, after having endured a siege of eight months, destroyed themselves and their city by fire, this temple, standing in a valley beyond the walls, escaped; and the cedar image of the goddess was found by Hannibal, who would not suffer it to be injured by his soldiers. The books of Numa, which were preserved so many centuries, are said to have been smeared over with the cedar, or juice of cedar. According to Virgil, the ancients used it in their dwelling-houses, as well as for their temples. What proportion of the above history belongs to the cedar of Lebanon, and what belongs to other Conifers, it is impossible at this distance of time to determine.

The modern history of the cedar of Lebanon is attended with much greater certainty. It may be said to commence with the revival of literature, as almost every modern traveller who has visited Syria has ascended Mount Lebanon, and recorded his visit. One of the first travellers who has given any particulars of Mount Lebanon is Belon, who travelled in Syria about 1550. About 16 miles from Tripoli, a city in Syria, he says, "at a considerable height up the mountain, the traveller arrives at the Monastery of the Virgin Mary, which is situated in a valley. Thence, proceeding four miles farther up the mountain, he will arrive at the cedars; the Maronites or the monks acting as guides. The cedars stand in a valley, and not on the top of the mountain; and they are supposed to amount to 28 in number, though it is difficult to count them, they being distant from each other a few paces. These the Archbishop of Damascus has endeavoured to prove to be the same that Solomon planted with his own hands in the quincunx manner, as they now stand. No other tree grows in the valley in which they are situated; and it is generally so covered with snow, as to be only accessible in summer." (*De Arb.*, &c., p. 4.) About this period, paying a visit to the cedars of Mount Lebanon seems to have been considered as a kind of pilgrimage; and, as every visiter took away some of the wood of the trees, to make crosses and tabernacles, the patriarch of the Maronites, fearing that the trees would be destroyed, threatened excommunication to all those who should injure the cedars; and, at the same time, exhorted all Christians to preserve trees so celebrated in Holy Writ. The Maronites were only allowed to cut even the branches of these trees once a year; and that was, on the eve of the Transfiguration of our Saviour; which festival occurs in August, and consequently at a suitable period for visiting the mountain. On this festival, the Maronites and pilgrims repaired to Mount Lebanon, and, passing the night in the wood, regaled themselves on wine made from grapes grown on the mountain, and lighted their fires with branches cut from the cedars. They passed the night in dancing a kind of Pyrrhic dance, and in singing and regaling; and the following day the festival of the Transfiguration was held on the mountain, and the patriarch celebrated high mass on an altar built under one of the largest and oldest cedars. (*Bel. in Arb. Con.*, &c.; and *Lois. in N. Du Ham.*, v. p. 300.) Dr. Hunter, in his notes to Evelyn's *Sylva*, says,—"we are informed, from the *Memoirs of the Missionaries in the Levant*, that, upon the day of the Transfiguration, the patriarch of the Maronites (Christians inhabiting Mount Libanus), attended by a number of bishops, priests, and monks, and followed by five or six thousand of the religious from all parts, repairs to these cedars, and there celebrates the festival which is called 'the Feast of Cedars.' We are also told that the patriarch officiates pontifically on this solemn occasion; that his followers are particularly mindful of the Blessed Virgin on this day, because the Scripture compares her to the cedars of Lebanon; and that the same holy father threatens with ecclesiastical censure those who presume to hurt or diminish the cedars still remaining." (*Hunter's Evelyn*, ii. p. 5.) La Roque, in his *Voyage de Syrie et du Mont Liban*, in 1722, mentions this fête; and adds:—"The Maronites say that the snows no sooner begin to fall, than these cedars, whose boughs are now all so equal in extent that they appear to have been shorn, never fail to change their figure. The branches, which before spread themselves, rise insensibly, gathering together, it may be said, and turn their points upwards towards heaven, forming altogether a pyramid. It is nature, they say, that inspires this movement, and makes them assume a new shape, without which these trees could never sustain the immense weight of snow remaining for so long a time." (*Voy.*, &c., as quoted in an able article on the cedar, in the *Gent. Mag.*, 2d series, iv. p. 578.) Rauwolf, who visited the cedars in 1574,

sumed to have existed in biblical times. Around these ancient witnesses of ages long since past, there still remains a little grove of yellow cedar, appearing to me to form a group of from 400 to 500 trees or shrubs. Every year, in the month of June, the inhabitants of Beschierai, of Eden, of Kanobin, and the other neighbouring valleys and villages, climb up to these cedars, and celebrate mass at their feet. How many prayers have resounded under these branches; and what more beautiful canopy for worship can exist!" Geramb was on Mount Lebanon in 1832, and reckoned about the same number of large trees as Pariset. (*Pèlerinage à Jérusalem, &c.*, vol. ii. p. 355.) M. Laure, an officer in the French marine, in company with the Prince de Joinville, visited Mount Lebanon in September, 1836. "After having quitted the village of Eden, the chief place of the Maronites," says M. Laure, "and having followed for two or three hours a path bordered sometimes by cultivated fields and plantations of mulberries, but more frequently by rocks, we arrived at El-Herzé, an almost level space or plain entirely surrounded by the steep peaks of the mountains. In this space, or rather hollow, are the celebrated cedars; and the circuit, not of the forest but of the plain, is not more than three or four miles. Fifteen of the sixteen old cedars mentioned by Maundrell are still alive, but are all more or less in a state of decay; and one of them is remarkable for three immense trunks, proceeding from the same stump, at a short distance above the soil. Another, one of the healthiest of the old trees, though perhaps the smallest, measured 33 ft. French (35 ft. 9 in. English) in circumference. All the trees are much furrowed by lightning, which seems to strike them more or less every year. In the middle of these old trees are about forty other cedars comparatively young, though the trunk of the smallest of them is from 10 ft. to 12 ft. in circumference. At the base of eight or nine of the old cedars are altars constructed with large and rough stones, which were formerly used by the inhabitants of the Maronite villages, who, headed by their pastor, went to El-Herzé on the day of the Transfiguration. At this festival all the priests said mass at the same time, each priest officiating at the foot of the cedar belonging to his village. Disputes having, however, arisen from this practice, the patriarch of the Maronites has made a new arrangement; and now, though the Maronites still continue on the festival of the Transfiguration to repair to El-Herzé, only one mass is celebrated, which is performed on the altar of a different cedar every year, in order that the trees of all the villages in turn may enjoy the same privilege. There is not one young cedar in all the wood of El-Herzé. The soil of the forest of Lebanon, on which there was not a single blade of grass growing in September, 1836, is covered to the thickness of half a foot with the fallen leaves, the cones, and scales of the cedars, so that it is almost impossible for the seeds of the trees to reach the ground and germinate." (*Laure in the Cultivateur Provençal*, p. 317. to 323, as quoted in *Deulongchamp's Histoire du Cèdre*, p. 63.)

The date of the introduction of the cedar into England is uncertain. Aiton, in the *Hortus Kewensis*, makes it 1683, the date of the planting of the trees in the Chelsea Botanic Garden; but, as these trees were 3 ft. high when planted, the introduction of the tree must at least be placed somewhat sooner, even supposing these trees to have been the first planted in Europe. The tree at Enfield is, however, probably as old. (See p. 48.) This tree, and the equally celebrated one at Hendon, blown down in 1779 (see p. 57.), are said to have been planted by Queen Elizabeth; but it is not likely that the cedar was introduced till long after her reign, as Turner does not mention it in his *Names of Herbes*; and Gerard and Parkinson, though they describe it in detail, speak of it as a plant that they have never seen. It is most probable that Evelyn was the introducer of the cedar, as he says, after praising it as a "beautiful and stately tree, clad in perpetual verdure," that it grows "even where the snow lies, as I am told, almost half the year; for so it does on the mountains of Libanus, from whence I have received cones and seeds of those few remaining trees. Why, then, should it not thrive in old England? I know not, save for want of industry and trial." It is extremely improbable that a man so fond

of trees as Evelyn, and so anxious to introduce new and valuable sorts into his native country, should have suffered "cones and seeds" of such a tree as the cedar to be in his possession, without trying to raise young plants from them; particularly as he was a man of leisure, residing in the country, and fond of trying experiments. (See Sir John Cullum's paper on this subject, in the *Gent. Mag.* for March, 1779.) Supposing Evelyn to have raised plants from his cones, the great cedar at Enfield may have been given by him to Dr. Uvedale; as Evelyn's *Sylva* was written in 1664, and Dr. Uvedale resided at Enfield from 1665 to 1670 (see *Hunter's Evelyn*, ii. p. 3.); between which years his cedar must have been planted. The story of the Enfield tree having been brought by one of the doctor's pupils from Mount Lebanon (p. 48.) rests solely on tradition; like that of the Enfield and the Hendon trees having been planted by Queen Elizabeth; and, possibly, one tale is not more worthy of credit than the other. Lord Holland is of opinion it was introduced by his ancestor, Sir Stephen Fox. In a letter to us dated November 23. 1836, His Lordship mentions a cedar at Farley, near Salisbury, the native village and burial place of Sir Stephen Fox, "the very first, I believe, ever planted in England. It was standing in 1812, near the vault of Sir Stephen Fox, who had imported it from the Levant; and who planted other cedars in the gardens at Chelsea." The cedar at Farley; His Lordship informs us in a subsequent letter, dated February 16. 1837, was, when he saw it in 1812, "barked, and some part of it lopped, in preparation for the axe. It was nearly the largest in girth that I had ever seen, but the branches, judging by what remained of them, did not grow boldly out from the trunk, but were more perpendicular, or cypress or poplar-tree fashioned, than is usual with cedars of Lebanon. That tree, or those at Chelsea or at Chiswick, all, I believe, planted under Sir Stephen Fox's direction, were unquestionably the first introduced into England. The circumstance is mentioned in Evelyn." We have not been able to find the passage alluded to. The particulars of the tree at Farley, Lord Holland had the kindness to procure for us from Mr. Thomas Parsons, who had them from the person who cut it down, and measured it. "He gave me," says Mr. Parsons, "the following information. The tree was stripped of its bark in 1812; the next winter it was grubbed down. He had 7*l.* for grubbing it down. I do not know what the expense of sawing off the root was. The expense of cutting the tree in quarters, viz., two cuts as it lay, each 14 ft. long, was 10*l.* The total weight of the tree was above 13 tons, without the bark; all the wood at and above 24 in. round included. All the rest went for firewood, of which there was an immense quantity. I remember, a few years before it was cut, there was a bough broken off by the weight of the snow.—*T. P. Farley, Feb. 2. 1837.*" According to a tradition in the family of Ashby, whose seat is at Quenby Hall, in Leicestershire, one of the first cedars raised in England was from seeds brought from the Levant by Mr. William Ashby, a Turkey merchant, and given by him to his nephew George Ashby, Esq., called in his time, and also on his monument, 'honest George Ashby, the planter,' who is supposed to have planted the old cedar in front of Quenby Hall, between 1680 and 1690. (See *Nichol's Hist. Leicest.*) William Ashby Ashby, Esq., the present possessor of Quenby Hall, has kindly endeavoured to find among his ancestor's papers some specific document respecting the introduction of the cedar, but could give us nothing farther than the general family tradition; except that Evelyn is said to have paid a visit to Quenby. The tree at Quenby Hall was, in 1837, 47½ ft. high, the trunk 7 ft. 9 in. in circumference at 1 ft. from the ground, and the diameter of the head about 71 ft.

When first introduced, the cedar, being a native of the hot climate of Syria, was supposed to be tender. Sir Hans Sloane, in a letter to Mr. Ray dated March, 1684-5, says:—"I was the other day at Chelsea, and find that the artifices used by Mr. Watts have been very effectual for the preservation of his plants; inasmuch, that this severe weather has scarce killed any of his fine plants. One thing I much wonder to see, that the *Cedrus Montis*

Libani, the inhabitant of a very different climate, should thrive here so well as without pot or green-house, to be able to propagate itself by layers this spring. Seeds sown last autumn have, as yet, thriven very well, and are likely to hold out. The main artifice I used to them has been to keep them from the winds, which seem to give great additional force to the cold in destroying tender plants." (*Ray's Letters, &c.*, p. 176.)

The cedars at Chelsea, as before observed, and several of those at Chiswick, in the grounds of the villa of the Duke of Devonshire, still exist, and these may, as they generally are, be considered the oldest yet standing in Britain. Evelyn had, doubtless, planted some cedars about the same time at Sayes Court; because in his letter to the Royal Society, detailing the effect of the previous severe winter, dated Sayes Court, Deptford, April 16. 1684, he says, "As for exotics, my cedars, I think, are dead." (*Misc. Writings, &c.*, p. 693.)

Whoever introduced the cedar, one of the greatest planters of it, in Miller's time, was the Duke of Richmond, who, as Collinson informs us, introduced many hundred plants in his park at Goodwood. Peter Collinson left the following MS. memorandum on this subject, in his copy of Miller's *Dictionary*. "I paid John Clarke, (a butcher at Barnes, who was very successful in raising cedars and other exotics,) for 1000 cedars of Lebanon, June 8th, 1761, 79l. 6s. in behalf of the Duke of Richmond. These 1000 cedars were planted at five years old, in my 67th year, in March and April, 1761. In September, 1761, I was at Goodwood, and saw these cedars in a thriving state. This day, October 20th, 1762, I paid Mr. Clark, for another large portion of cedars, for the Duke of Richmond. The duke's father was a great planter, but the young duke much exceeds him; for he intends to clothe all the lofty naked hills above him with evergreen woods. Great portions are already planted, and he annually raises for that purpose infinite numbers of pines, firs, and cedars." (MS. notes, communicated by Mr. Lambert to the *Linn. Soc. Trans.*, vol. x. p. 275.) Of the cedars at Goodwood, the present Duke of Richmond informed us, in 1837, that 139 remain. The cedar appears to have first produced cones in England, in the Chelsea Botanic Garden, about 1766: since which, partly from imported cones, and partly from cones ripened in this country, it has been extensively multiplied, and there are now few gentlemen's seats in Great Britain that do not possess several trees.

The first cedars planted in Scotland appear to have been some at Hopetoun House, which, tradition says, were brought thither by Archibald Duke of Argyll, in 1740. (See p. 102.) The date given by Dr. Walker, is 1748; but the same author elsewhere states that the cedar was not planted anywhere in Scotland till after 1730, thereby showing that he had no positive data as to the year of its introduction. Boutcher, writing in 1775, says that he had raised more cedar trees than any other man in Scotland; and that he was the first who made them common in that part of the island. When it was introduced into Ireland is uncertain. (See p. 114.)

The cedar was not introduced into France till 1734, when Bernard De Jussieu, returning from his first visit to England, brought with him two plants, so small, that, to preserve them more securely, he is said to have carried them in the crown of his hat. One of these plants was placed on the mount in the Jardin des Plantes (see p. 137. and p. 2405.); and it was not known what had become of the other, till, in 1832, it was discovered by M. Mérat, at the Château de Montigny, near Montereau, a little town about eighteen leagues from Paris. This château was built by Daniel-Charles Trudaine, Intendant des Finances under Louis XV., and embellished by his son, Trudaine de Montigny; but, in 1836, it was in the possession of an English nobleman. (*Ann. & Hort. de Paris*, xviii. p. 114.) The tree in the Jardin des Plantes was measured by Loiseleur Deslongchamps in January, 1812, and again in March, 1837. At the former period, the circumference of the trunk was 8 ft. 8 in.; and, at the latter, 10 ft. It was observed to this author, by Professor Desfontaines, that this cedar had been greatly injured by an accumulation of soil, which was

heaped up round the base of its trunk, as high as 3 ft., about 30 years ago; and indeed, had not the tree been planted on a mound of rubbish, which was dry, and consequently pervious to the atmosphere, the accumulation of soil must have killed it. The cedar at Montigny, planted at the same time as that in the Jardin des Plantes, but in a good soil, has a trunk at least one third larger than that of the tree in the Jardin des Plantes. A cedar planted on the estate of Du Hamel, at Vrigny, near Pithiviers, in 1743, had, in 1835, a trunk 12 ft. 8 in. in circumference, at the height of 6 ft. from the ground, and 16 ft. in circumference at the base. This tree is between 70 ft. and 80 ft. high, French (between 75 ft. 10 in. and 86 ft. 8 in. English), and is in a very flourishing state, resembling a magnificent pyramid. M. Loiseleur Deslongchamps mentions two other fine cedars at Vrigny, and several at Denainvilliers; both estates which belonged to the celebrated Du Hamel, and which are now the property of his grand-nephew, M. Fougereux. Other remarkable cedars in the neighbourhood of Paris are, one in the ancient garden of the Maréchal des Noailles, at St. Germain; that in the garden Marbœuf, in the Champs-Élysées; those of Trianon, which are from 8 ft. to 10 ft. in circumference, at the height of a man from the ground; and one in the park at Franconville, seven leagues north from Paris, the property of M. A. Leroux, which, in May, 1837, had a trunk 12 ft. 3 in. in circumference at the base, and which was planted by a man who was still alive in 1837, and who was then 90 years of age. (*Hist. du Cèdre du Liban, &c.*, p. 39.)

It appears from the ages and dimensions of these trees, that the cedar thrives fully as well in France as it does in England; and, as there is a great want of evergreens in the neighbourhood of Paris, and in all those parts of France which have an equally cold climate, it seems very desirable that the cedar should be more generally planted in that country than it at present is. The greatest planter of cedars in France appears to have been the father of the present Viscount Hericart de Thury, who, in 1780, planted many trees on the mountain of St. Martin-le-pauvre, Department de l'Oise. These trees, in 1837, Loiseleur Deslongchamps informs us, were in a state of the most vigorous vegetation. (*Ibid.*, p. 45.) The tree is propagated in all the principal French nurseries; partly from imported cones, and partly from cones ripened in the country.

The botanical history of the cedar is short. Dodonæus, and other ancient obtanists, called it *Cedrus magna*, the great cedar, adding other epithets; but all agreeing that it was one of the Coniferæ. Tournefort considered it a larch, and called it *Làrix orientàlis*; in which he was followed by Du Hamel. Miller called it *Làrix Cèdrus*. Linnæus considered it to be a pine; and his name for it of *Pinus Cèdrus* has been adopted by most of the Continental and British botanists. Poirêt, in his *Dictionnaire Encyclopédique*, calls it *A'bies Cedrus*; and he has been followed by Loiseleur Deslongchamps, in his very able article on the cedar in the *Nouveau Du Hamel*, and in his *Histoire du Cèdre, &c.*, received by us since this article has been in type; and by Dr. Lindley, in the *Penny Cyclopædia*. Barrelier, in his posthumous work, *Plantæ per Galliam, Hispaniam, et Italiam observatæ*, published in 1714, at Paris, by Jussieu, makes it a distinct genus, and calls it *Cèdrus Libani*.

Poetical Allusions. The cedar is frequently mentioned by the Latin poets; but most of the allusions appear to have reference to the junipers that are called cedars, rather than to the cedar of Lebanon. Virgil, speaking of the forests of Caucasus, says,—

— "Dant utile lignum
Navigis pinos, domibus cedrosque, cupressosque."

Geor., li. 442.

— "Heaven their various plants for use designs;
For houses cedars, and for shipping pines.

Dryden's Trans.

Ovid, in the first of his *Elegies*, says that an illuminated title, and paper stained with the juice of the cedar, would ill agree with the unhappy circumstances of their author:—

"Nec titulus minio, nec cedro charta notetur."

Trist., l. 7.

Alluding to the custom of anointing the leaves of books with cedar juice, to preserve them from the depredations of the worm.

Lucan speaks of it as the breeding-place of the eagle; and Horace hopes that his verses will be as lasting as its wood.

Among the British poets, Spenser thus describes a cedar:—

“ High on a hill a goodly cedar grew,
Of wondrous length and straight proportion,
That far abroad her dainty odours threw,
‘Mongst all the daughters of proud Lebanon.”

Churchill says,—

“ The cedar, whose top notes the highest cloud,
Whilst his old father Lebanon grows proud
Of such a child, and his vast body, laid
Out many a mile, enjoys the filial shade.”

Mason describes the cedar as spreading:—

— “ Cedars here
Coeval with the sky, crown’d mountain’s self,
Spread wide their giant arms.”

Thomson gives a beautiful picture:—

— “ On some fair brow
Let us behold, by breezy summers cool’d,
Broad o’er our heads the verdant cedar wave.”

Shakspeare’s lines on the fall of Warwick are well known:—

“ Thus yields the cedar to the axe’s edge,
Whose arms gave shelter to the princely eagle,
Under whose shade the ramping lion slept,
Whose top branch overpeer’d Jove’s spreading tree,
And kept low shrubs from winter’s powerful wind.”
Third Part of Henry VI., act v. sc. 3.

In the last scene of Henry VIII., Cranmer says, speaking of James I.,—

— “ He shall flourish,
And, like a mountain cedar, reach his branches
To all the plains about him.”

Shakspeare makes several other allusions to the cedar. Drayton calls it “ the tufted cedar;” and Fairfax, “ the proud cedar.” Spenser also calls it “ the cedar proud and tall;” and Sir Philip Sydney terms it “ queene of the woods.”

Many allusions to this tree are also found among the modern poets:—

— “ On high the cedar
Stoops, like a monarch to his people bending,
And casts his sweets around.” *BARRY CORNWALL.*

“ Down in a vale, where lucid waters play’d,
And mountain cedars stretch’d their downward shade.” *MONTROBERT.*

The following lines from Southey allude to the power supposed to be possessed by the cedar of freeing itself from the snow. (See p. 2410.)

— “ It was a cedar tree
That woke him from the deadly drowsiness;
Its broad round-spreading branches, when they felt
The snow, rose upward in a point to heaven,
And, standing in their strength erect,
Defied the baffled storm.” *Thalaba.*

Moore says,—

“ Now upon Syria’s land of roses
Softly the light of eve reposes,
And, like a glory, the broad sun
Hangs over sainted Lebanon.” *Paradise and the Peri.*

“ As Lebanon’s small mountain flood
Is render’d holy by the ranks
Of sainted cedars on its banks!” *Lalla Rookh.*

The following verses of Racine are so well known, and so much admired, in France, that we quote them:—

“ J’ai vu l’impie adoré sur la terre :
Pareil au cèdre, il cachait dans les cieux
Son front audacieux ;
Il semblaît à son gré gouverner le tonnerre,
Foulait aux pieds ses ennemis vaincus :
Je n’ai fait que passer, il n’était déjà plus.”

Many other examples might be given ; but these will suffice to show the use the poets have made of this tree.

Properties and Uses. The wood of the cedar is of a reddish white, light and spongy, easily worked, but very apt to shrink and warp, and by no means durable. The horizontal section, as Loiseleur Deslongchamps justly observes, exhibits the annual layers very distinctly marked. Each year has apparently two layers ; the one narrow, close-grained, hard, and of a reddish brown ; and the other three or four times broader, loose, spongy, and whitish. In general, the section of the trunk of a cedar bears a nearer resemblance to that of the silver fir, than to that of any other of the *Abietinæ*. When the tree has grown on mountains, the annual layers are much narrower, and the fibre much finer, than when it has grown on plains ; so much so, that a piece of cedar wood brought from Mount Lebanon by Dr. Pariset, in 1829, and which he had made into a small piece of furniture, presented a surface compact, agreeably veined, and variously shaded ; and which on the whole may be considered handsome. (*Hist. du Cèdre, &c.*, p. 43.) The weight of the wood of the cedar, according to Varennes de Fenille, is 29 lb. 4 oz. per cubic foot ; but Mussenbrack makes it 42 lb. 14 oz., and Hassenfratz 57 lb. This enormous difference, says Baudrillart in the *Dictionnaire des Eaux et Forêts*, is enough to convince us that the wood could not be in the same state of dryness. The average of these weights gives 43 lb. per cubic foot ; but it is doubtful whether the wood of the cedar weighs so much. Varennes de Fenille considers it as the lightest of the resinous woods ; and he adds that it contains very little resin, that its grain is coarse, and that he thinks the wood can be neither so strong nor so durable as it has the reputation of being. He continues, that we cannot suppose that the temples of Jerusalem and Ephesus were of the dimensions stated ; or, if they were, that the wood of the cedar of Lebanon was used in their construction. He is still more incredulous as to the statue of Diana having been sculptured of so soft a wood, and one the grain of which was so unequal and subject to crack ; besides which, he says that the smell of the wood, so far from being fragrant, greatly resembles that of the pine. It is very liable to warp and split in drying, on which account it does not hold nails well (a remark which was made by Pliny) ; and it is unfit for use, except in large masses. A table which Sir Joseph Banks had made out of the Hillingdon cedar was soft, without scent (except that of common deal), and possessed little variety of veining ; and the same remarks will apply to a table which we have had made from the plank already referred to, as having been kindly presented to us by J. Gostling, Esq., of Whitton Park. The wood of the cedar burns quickly, throwing out many sparks, though but little heat in comparison with that of the oak or the beech ; though the flame of the cedar wood is more lively and brilliant, on account of the resin which it contains. The charcoal formed from it is very light, produces little heat, and becomes quickly covered with ashes, like the charcoal of the poplar and of the willow. The bark may be used in tanning ; and, according to an analysis made by Professor Chevreuil, its astringent properties are, to that of the oak, as 12.75 is to 19.75. The resin of the cedar resembles that of the larch, but it is much less abundant. It flows from wounds made accidentally or by design in the bark, and from the scales of the cones, but no use is made of it. The resin is very abundant in the seeds, being, according to an analysis made by Professor Chevreuil, 41 per cent ; while in those of the *Pinus Cembra* it is 21 per cent, in those of the *P. Pinaster* 24 per cent, and in those of the *P. Pinæa* 9½ per cent. The leaves which fall from the trees remain on the ground for several years before they become mould ; and Loiseleur Deslongchamps, having seen a plantation of cedars of 15 years' growth, with a layer of decaying leaves and mould on the ground underneath the branches of ½ in. in thickness, and having learned also that this layer under the old trees of Mount Lebanon is above a foot thick, suggests the idea of planting the cedar on the poorest soils, with a view of ultimately enriching them, and rendering them fit for the growth of pasture

or corn. The pollen of the male flowers, which is produced in immense quantities, is a fine powder, of a lively yellow, without taste or smell; which inflames readily, and burns brightly, like that of the powder of the *Lycoperdon*, which it greatly resembles. It has been analysed by M. Macaire Prinsep (*Bib. univers. de Genève*, 1830, p. 45.), but it has not been yet applied to any useful purpose.

The wood called cedar by the ancients was supposed so incorruptible, that the expression of *dignus cedro* (worthy to be preserved in cedar) was applied to anything thought worthy of immortality; and, in allusion to this, Persius says, in his first satire, "*Et cedro digna locutus*" (worthy to be placed in cedar). The words "*cedro digna*" are often applied as a compliment at the present day. The resinous products of the tree were, like the wood, highly valued by the ancients. The Romans believed that the gum which exuded from this tree, and which they called *cedria*, had the property of preserving incorruptible every thing that was steeped in it. Vitruvius states that the leaves of papyrus, when rubbed with it, were never attacked by the worms; and Pliny, that the books of Numa, which were found uninjured in the tomb of that prince, 500 years after his death, had been steeped in the oil of cedar. The Egyptians also used this *cedria* in embalming their dead; and Pliny, Dioscorides, Scribonius Largus, &c., recommend the *cedria* for curing the toothache, and for various other complaints.

As an ornamental object, the cedar is one of the most magnificent of trees; uniting the grand with the picturesque, in a manner not equalled by any other tree in Britain, either indigenous or introduced. On a lawn, where the soil is good, the situation sheltered, and the space ample, it forms a gigantic pyramid, and confers dignity on the park and mansion to which it belongs; and it makes an avenue of unrivalled grandeur, if the trees are so far apart as to allow their branches to extend on every side. If planted in masses, it is, like any other species of the pine and fir tribe, drawn up with a straight naked trunk, and scarcely differs in appearance from the larch, except in being evergreen. This is exemplified at Kenwood, at Claremont, and other places near London. On the other hand, where the cedar is planted in masses, and a distance of 50 ft. or 60 ft. allowed between each tree, nothing in the way of sylvan majesty can be more sublime than such a forest of living pyramids. This is exemplified around the cedar tower at Whitton, and on the cedar bank at Pepper Harrow.

Gilpin, speaking of the cedar of Lebanon, says:—"To its preeminence belongs, not only on account of its own dignity, but on account of the respectable mention which is every where made of it in Scripture. Solomon spake of trees, from the cedar of Lebanon, to the hyssop that springeth out of the wall; that is, from the greatest to the least. The Eastern writers are, indeed, the principal sources from which we are to obtain the true character of the cedar, as it is an Eastern tree. In the sacred writers particularly, we are presented with many noble images drawn from its several qualities. It is generally employed by the prophets to express strength, power, and longevity. The strength of the cedar is used as an emblem to express the power even of Jehovah:—'The voice of the Lord breaketh the cedars of Lebanon.' David characterises the palm tree and the cedar together, both very strongly.—'The righteous shall flourish like a palm tree, and spread abroad like a cedar of Lebanon.' The flourishing head of the palm, and the spreading abroad of the cedar, are equally characteristic. But the prophet Ezekiel hath given us the fullest description of the cedar:—'Behold, the Assyrian was a cedar in Lebanon, with fair branches, and with a shadowing shroud, and of a high stature; and his top was among the thick boughs. His boughs were multiplied, and his branches became long. The fir trees were not like his boughs, nor the chestnut trees like his branches, nor any tree in the garden of God like unto him in beauty.' In this description, two of the principal characteristics of the cedar are marked: the first is the multiplicity and length of its branches. Few trees divide so many fair branches from the main stem, or spread over so large a compass of ground. 'His boughs are multi-

plied,' as Ezekiel says, 'and his branches become long;' which David calls spreading abroad. His very boughs are equal to the stem of a fir or a chestnut. The second characteristic is, what Ezekiel, with great beauty and aptness, calls his shadowing shroud. No tree in the forest is more remarkable than the cedar for its close-woven leafy canopy. Ezekiel's cedar is marked as a tree of full and perfect growth, from the circumstance of its top being among the thick boughs. Every young tree has a leading branch or two, which continue springing above the rest till the tree has attained its full size: then it becomes in the language of the nurseryman, clump-headed; but, in the language of Eastern sublimity, its top is among the thick boughs; that is, no distinction of any spiry head, or leading branch, appears; the head and the branches are all mixed together. This is generally, in all trees, the state in which they are most perfect and most beautiful; and this is the state of Ezekiel's cedar. But, though Ezekiel hath given us this accurate description of the cedar, he hath left its strength, which is its chief characteristic, untouched. But the reason is evident: the cedar is here introduced as an emblem of Assyria; which, though vast and wide-spreading, and come to full maturity, was, in fact, on the eve of destruction. Strength, therefore, was the last idea which the prophet wished to suggest. Strength is a relative term, compared with opposition. The Assyrian was strong, compared with the powers on earth; but weak compared with the arm of the Almighty, which brought him to destruction. So his type, the cedar, was stronger than any of the trees of the forest; but weak in comparison with the axe, which cut him off and left him (as the prophet expresses the vastness of his ruin) spread upon the mountains and in the valleys, while the nations shook at the sound of his fall. Such is the grandeur and form of the cedar of Lebanon. Its mantling foliage, or shadowing shroud, as Ezekiel calls it, is its greatest beauty; which arises from the horizontal growth of its branches forming a kind of sweeping irregular penthouse. And, when to the idea of beauty that of strength is added, by the pyramidal form of the stem, and the robustness of the limbs, the tree is complete in all its beauty and majesty. In these climates, indeed, we cannot expect to see the cedar in such perfection. The forest of Lebanon is, perhaps, the only part of the world where its growth is perfect; yet we may in some degree perceive its beauty and majesty from the paltry resemblances of it at this distance from its native soil. In its youth, it is often with us a vigorous thriving plant; and, if the leading branch is not bound to a pole (as many people deform their cedars), but left to take its natural course, and guide the stem after it in some irregular waving line, it is often an object of great beauty. But, in its maturer age, the beauty of the English cedar is generally gone: it becomes shriveled, deformed, and stunted; its body increases, but its limbs shrink and wither. Thus it never gives us its two leading qualities together. In its youth, we have some idea of its beauty, without its strength; and in its advanced age, we have some idea of its strength, without its beauty: the imagination, therefore, by joining together the two different periods of its age in this climate, may form some conception of the grandeur of the cedar in its own climate, where its strength and beauty are united. The best specimen of this tree I ever saw in England was at Hillingdon, near Uxbridge. The perpendicular height of it was 53 ft., its horizontal expanse 96 ft., and its girt 15 ft. 6 in. When I saw it in 1776, it was about 118 years of age; and, being then completely clump-headed, it was a very noble and picturesque tree. In the high winds, about the beginning of the year 1790, this noble cedar was blown down. Its stem, when cut, was 5 ft. in diameter." (*For. Scen.*, i. p. 81.) On these observations of Gilpin we shall only remark, that there are now, 1837, 60 years after Gilpin saw the cedar at Hillingdon, many hundred cedars in England more grand and picturesque than that tree; and, not to go further than Syon, Whitton, and Pain's Hill, there are at these places, cedars which are both higher, and cover a larger space with their branches, than that at Hillingdon. With respect to the age which Gilpin assigns to the Hillingdon

tree, it is probably incorrect; if otherwise, it must have been upwards of 20 years older than those at Chelsea.

Mr. Thompson, an artist, writing in the *Gardener's Magazine* on the effect of the cedar in landscape scenery, observes that "there is something even architectural in the form of the cedar; the thick upright stem, and the horizontal branches which it supports, in a great measure accord with the pillars and copings of buildings. This may be seen by reference to the inspired pictures of Martin, when Assyrian history has been the subject of his pencil. He has realised all that the most vivid imagination could conceive of Eastern splendour; and the famous hanging gardens have not been forgotten. In them the cedar is the most prominent tree, which he has shown mixed with cypresses and a few low shrubs and flowers, forming a mass simple but grand, and quite in unison with the architectural character of the scene. The accompanying sketch (*fig. 2275.*) is from an etching of the destruction of Babylon, and represents part of the hanging gardens. Thus it may be inferred that



cedars should always be the accompaniment of palaces, public buildings, and superior residences. The finest cedars I have seen are at Blenheim; but even there they are not much contrasted with the architecture, but are spread generally throughout the whole of the gardens; and they appeared to me in a great measure lost, from being so mixed up with other trees and shrubs: however, they serve to maintain the character of grandeur which belongs to the place. On the banks of the great lake, where the present duke, since he left White Knights, has formed his new flower-garden, extending from the house to the cascade, there are some very fine cedars; and it is curious to observe how well they accord with the simplicity of garden scenery: but this may be accounted for by their being supported by other large trees, from the extensiveness of the gardens, and from every thing around them being on so grand a scale. There are some garden scenes in which cedars would be found not only misplaced, but out of character, and injurious: as, for example, in the grounds of a small modern villa, they would be quite at variance with our ideas and associations as to what should attach to such a place. The accompanying sketch (*fig. 2276.*), though it forms a tolerable picture, will, I trust, illustrate what I have been stating. The villa is rendered insignificant by the stately presence of the cedars; and the cedars seem to have been there before the villa was built, as if they came by accident, and were foreign to the scene. In the next sketch (*fig. 2277.*), where I have supplied their place with a few pendent and appropriate trees, the picture produced seems more consistent, more complete, and in better keeping. The form and character of the cedar are not suited to anything on a small scale, or that betrays want of effect in its architectural features, or in the disposition of the ground: thus, one would not place them in the centre of a home meadow or arable field, where oaks and elms are sometimes met with having a very good effect; nor should they ever appear where the scenery is either domestic, homely, or tame. Nothing is more offensive, than to find a cedar, a cypress, or other stately tree, con-



trasting itself with hay-ricks, corn stacks, and dovecots, in the garden of some old farm-house; which, though little remains of its former greatness, might originally have been the residence of the lord of the manor, or of some titled person. When, however, any of these old-fashioned red-brick residences are to be met with in their original state, their terraces adorned with vases and figures; their gardens in the old geometric style, with costly iron palisading, &c.; a few venerable cedars will generally form a highly grand and picturesque addition to the scene. Cedars will not bear to be planted too thickly, or too close together: they should be placed by twos and threes, in conspicuous situations, such as on small mounds, or by the side of water, next to bridges or temples; sometimes on lawns, or rising grounds, that command extensive prospects, where they may serve as a foreground; but they must not be made common by being seen at every turn. Too many cedars, in any situation, will always destroy their own effect: they are of such an exclusive character, that they are more calculated to act upon a scene as figures do in landscape composition, than to form the basis of it. A red-coated soldier or two would enliven a view, but a file of them would be any

2277



thing but picturesque: unless, indeed, in a battle scene, where they formed the principal feature. So it should be with the cedars: if they must be together, let them form a grove; they would then have a character of gloomy magnificence, which might be a very fine addition to a residence. I should imagine that such a grove of full-grown cedars would be highly interesting and attractive. We will just suppose that the banks of an artificial river or lake were bounded on one side by grassy hills, planted with a few evergreens and birches, and that the other side was a gentle slope, covered with a grove of cedars; that a winding and almost natural path conducted you among their



2278

ponderous trunks; that the grass was kept tolerably free from weeds; that hollyhocks, peonies, roses, and other flowers of a large and imposing character, were raising their heads here and there; and that the woodbine was also twining around some of the trees: then suppose a clear summer evening, the water reflecting the yellow light of the sunset, and the trunks of the cedars touched by its rays; and I think we shall have conceived one of the calmest and most solemn scenes that could be found in nature, or that it is in the power of art to create. In the above sketch (*fig. 2278.*), I have endeavoured to convey some idea of the subject; but the smallness of the scale, and the absence of colour, are much against my portraying such a scene.

"I would not recommend the introduction of cedars into plantations or belts, as they are generally lost amidst the other trees; and, if brought to the margin of the plantation, they form too violent a contrast with what is around them. They may be sparingly introduced in clumps; but, when they are, they should always take the lead: a few dwarf round-headed trees or shrubs, with the poplar or cypress, are the best forms to group with them. (See *fig. 2279.*)

2279

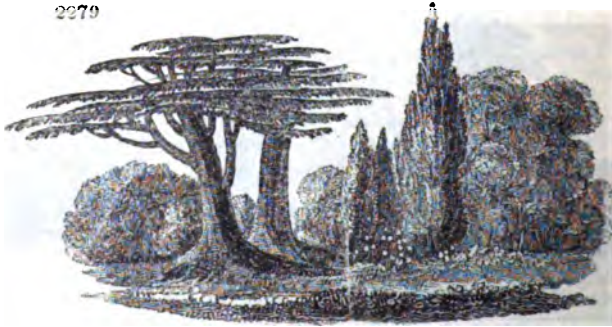

However, they are much better solitary; and in the fore courts of palaces, or other buildings of sufficient consequence, I would have nothing but a cedar or two. It is said that the New Palace at Pimlico is to have a large area before it, surrounded by a railing of mosaic gold: the broad carriage-way, the dark grass, and a few cedars, are all that I would introduce in it; unless it were a very few flowering shrubs, hollyhocks, or standard roses, and these not in dug beds, but on the grass. There are two cedars on a small mound at Syon House, which may be viewed from the Thames, and which are sure to attract

the attention of every artist. I have seen numerous sketches and drawings of the scene around them, and I may venture to say that it was the cedars, and they only, that were the inducement. Those in the Botanic Garden at Chelsea (see fig. 2270. in p. 2405.) are never passed unheeded; thus showing how valuable cedars are in landscape composition, and, consequently in landscape-gardening." (*Gard. Mag.*, i. p. 122.)

The architectural character of the cedar, noticed by Mr. Thompson, has rendered this tree a great favourite with painters, and more especially with the justly celebrated Martin. This great artist has introduced the flat head of the aged cedar into his imaginary view of the Garden of Eden (*fig. 2280.*);

2280



into the terraces of the gardens of Babylon (*fig. 2281.*); and into his *beau idéal* of the gardens of Nineveh (*fig. 2282.*), as shown in his celebrated picture of the fall of that city.

Soil, Situation, Propagation, &c. The cedar, as may have been observed in the case of the Chelsea trees, thrives well in dry gravelly soils, where the roots can have access to water; which may be said to be the case with most of the *Abiétinæ*. Perhaps it may be sufficient to observe, that the cedar will grow in every soil and situation suitable for the larch. We are not certain that it will grow equally well with that tree at great elevations; though we have little doubt of it, provided it were planted in masses. In the neighbourhood of London, it has certainly attained the largest size in deep sandy soil, as at Syon, Whitton, and Pain's Hill; but the sand at these places is not poor; and at Whitton, where the tree has attained the greatest height and bulk, the roots are within reach of water. Boucher observes that no tree will grow in more forbidding, poor, and hungry soil, than the cedar; and he instances, in proof of this, the trees on Mount Lebanon; but these, in point of height and the spread of the branches, are mere bushes in comparison with those at Whitton. The cones, which, as already observed, are not ripe till the autumn of the third year, will keep five or six years after being taken from the tree, so that there is never any risk of getting seeds too old to vegetate, in purchasing the cones that are imported from the Levant. If cones produced in Britain are kept a year after being gathered, they may be opened with greater ease than when recently taken from the tree. To facilitate the operation of extracting the seeds, the cones may be steeped in water for a day or two, and afterwards split by driving a sharp conical iron spike through their

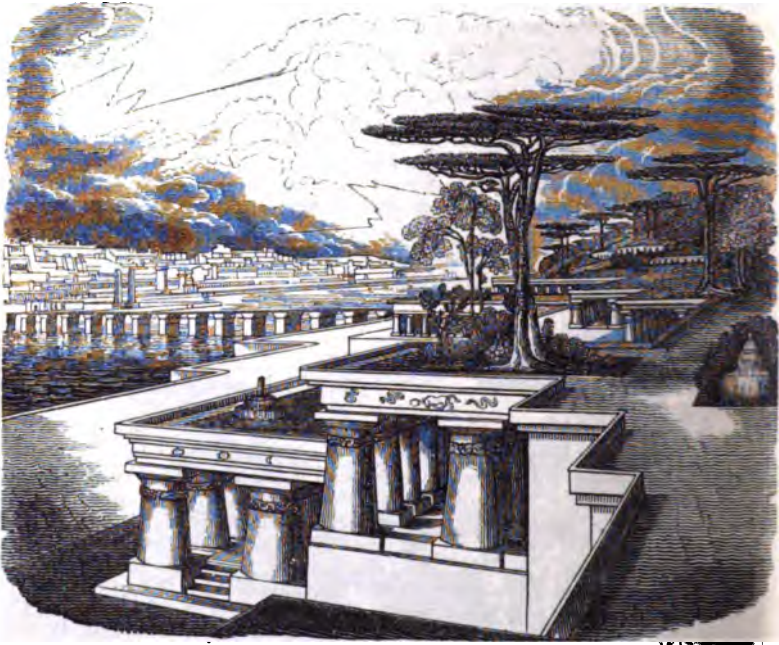

2281

axis. The scales being then opened with the hand, the seeds readily come out. The following mode of extracting the seeds is recommended by M. Loiseleur Deslongchamps:—“As good seeds are never found within 6 or 8 lines of either the base or the summit of cones, the extreme ends of each cone are first sawn off; the cones, for this purpose, being put into a vice. After this a hole may be drilled through the axis, or they may be split in the manner already recommended. According to M. Loiseleur Deslongchamps, a workman will prepare 20 cones in an hour; each cone, if somewhat large, will contain 100 seeds, and consequently one man may separate 20,000 seeds in a day. The smaller cones contain from 30 to 60 seeds; and the larger from 110 to 170 seeds, exclusive of from 10 to 15 per cent of abortive seeds.” (*Hist. du Cèdre, &c.*, p. 50.) These abortive seeds are filled with a soft resinous matter, instead of a kernel; and they may easily be separated from the perfect seeds, by throwing the whole into water before sowing. The seeds ought to be committed to the soil immediately after being taken out of the cones; more especially if the latter have been steeped, because in that case the seeds have swelled, and might be injured, if left to shrink. If the seeds are sown in March or April, they will come up in a month or six weeks; and still sooner if they have been steeped. Like the other *Abiétinæ*, they should be sown in light rich soil, and covered thinly. Sang recommends the covering to be $\frac{1}{2}$ in. deep; and this depth may be diminished or increased, according to the lightness or heaviness of the soil. The seeds may be either sown in beds in the open garden, or in large flat pots or boxes; but the latter is the more convenient mode, as it admits of preserving the whole of the roots in transplanting. The plants rise 3 in. or 4 in. high the first year, with scarcely any taproots; but these increase afterwards, as the plants advance in size. At the end of the first year, the seedlings may be transplanted into nursery lines, or, what is more convenient, into small pots; and, in commercial nurseries, they should every year be shifted into pots a size larger, till they are sold



2282

In private nurseries, where the plants are not likely to be sent to any distance, they may be planted in the free soil in nursery lines, like the pinaster and other of the more rare pines and firs; and, when they are removed to their final situation, their roots may be protected from the air, by immersing them in mud or puddle. In the nursery culture of the cedar, care must be taken not to injure the leading shoot, which is said not to be readily renewed when broken off. In general, it is advisable to tie the leader to a stake, till the plants are placed where they are finally to remain; after which they may be left to themselves. In their progress from young plants to full-grown trees, they require very little pruning, and suffer severely when large branches are cut off. Miller mentions two of his four trees, which had some branches cut off to admit the rays of the sun into a green-house, whereby they were so much checked, as, in above 40 years' growth, to be little more than half the size of the other two, which were not pruned; and, Boucher having planted two trees, they grew for 16 years amazingly fast, and promised to be noble plants, till an ignorant gardener unadvisedly cut off several of their oldest under branches; after which, he says, they advanced little or nothing in height, lost their leading shoots, and became ragged and bushy. Notwithstanding this, it is the practice of nurserymen to shorten the lateral branches of the larger plants kept for sale; and it does not appear that they suffer much by it. When the cedar is planted in close masses, either alone or with other trees, the side branches are choked, but still the tree continues to grow almost as rapidly as the larch, or silver fir, when similarly treated; so that, after all, the cedar is, perhaps, not more injured by the removal of its side branches, than any other pine or fir would be. All the *Abiétinæ*, as we have before stated, suffer more or less by the shortening or removal of branches, whether small or large, which have not begun to decay.

Accidents, Diseases, &c. The wide-spreading branches of the cedar are apt to be weighed down and broken by heavy falls of snow; but the tree is less liable to be blown down by high winds than the larch, or such pines and firs as do not throw out wide-spreading branches near the ground. It is not subject to diseases, and it is less liable to be attacked by insects, as far as we have heard or observed, than any other species of the pine and fir tribe. The seeds being large are eagerly sought after by squirrels; but these animals, in parks and pleasure-grounds, are generally considered more ornamental than injurious.

Statistics. Recorded Trees. The large tree at Hillingdon has been already mentioned, and its dimensions are given in p. 59. The dimensions of the large cedar at Hendon are given in p. 57; and those of the Enfield cedar in p. 46. Another remarkable tree, not so well known as the above, is that already noticed as having been planted by Sir Stephen Fox, in his native village, and burial place, of Farley, near Salisbury, about the same time as, or before, those at Chelsea and Chiswick. The Farley cedar was cut down by the late Earl of Radnor in 1812, and was then 66 ft. high; the diameter of the trunk 5 ft. 6 in., and that of the space covered with its branches, from east to west, 130 ft. It was a remarkably sound tree, not a single branch being decayed. The Hammermith cedar (fig. 2372. in p. 2406.), cut down in 1836, was 59 ft. high, the diameter of the trunk about 5 ft., and

of the head 80 ft. The house to which it belonged was once the residence of Oliver Cromwell; and tradition says that he there signed the warrant for the execution of Charles I.

Remarkable existing Trees. The oldest trees now standing in Britain are supposed to be the two cedars still remaining of the four which were planted in the Chelsea Garden in 1683; the cedar at Enfield; and probably some of those at Chiswick House, formerly the property of Sir Stephen Fox, who died there in 1714 or 1715. The largest of the Chelsea cedars is nearly 60 ft. high, with a trunk about 5 ft. in diameter; and the other is very nearly the same size. Both trees have lost all their lower branches (see fig. 270. in p. 2405.), and have a miserable and stunted appearance. The largest cedar at Chiswick (now the Duke of Devonshire's) is 70 ft. high, diameter of the trunk 4 ft. 6 in., and of the head 65 ft. The loftiest cedar in England appears to be one at Strathfieldsaye, which is 108 ft. high, diameter of the trunk 3 ft., and of the head 74 ft. The highest in the neighbourhood of London is at Claremont, and is 100 ft. high, diameter of the trunk 5 ft. 6 in. The largest cedar tree in England is, probably, the magnificent specimen at Syon, figured in our last Volume, and it is unquestionably the handsomest. This noble tree is 75 ft. high, diameter of the trunk, at 3 ft. from the ground 8 ft., and of the head 117 ft. At Charley Wood, near Rickmansworth, on an estate of the Duke of Bedford, are, near the house, eight remarkable cedars, the largest of which has a trunk 18 ft. in circumference, dividing into 12 large limbs, from which spring 32 branches, of a size fit to be measured as timber, and containing 613 solid cubic feet. The head covers a space nearly 100 ft. in diameter, or about the sixth of an acre. The cedars at Wilton, near Salisbury, are also remarkably fine trees, and were once so celebrated as to entitle the place, according to Mitchell, to the name of the British Mount Lebanon. It appears from a paper communicated to Mr. Lambert by the Hon. and Reverend William Herbert, that the cedars at Wilton were probably raised between 1710 and 1720. He adds, that they were kept by "the Countess of Pembroke, in pots at her window; till, growing too large, they were planted upon the lawn between the house and the water; a situation very favourable to their growth." The largest of these trees measured, in 1835, at 3 ft. from the ground, nearly 7 ft. in diameter; and at 1 ft. from the ground, 8 ft. 9 in. in diameter. (See an able paper on the subject of the cedar, by the Rev. J. Mitford, in the *Gen. Mag.*, 2d ser., vol. iv. p. 579.) "There is a cedar, at Osgood Hanbury's, near Coggeshall, in Essex, which is of interest, as it was planted by Collinson's own hand, 67 years since, in 1768. We transcribe the memorandum on the subject very kindly sent us by Mr. Hanbury: 'In token of the love and friendship which has for so many years subsisted between myself and my dear friend John Hanbury and his family, and as a lasting memorial of that friendship, I desire that one guinea may be given to my sincere friend Osgood Hanbury, to purchase of Gordon two cedars of Lebanon, to be planted in two places of the new part of the park last taken in. Let the occasion of the said cedars and of their ages be registered in the Great Bible at Coggeshall, that succeeding generations may know our friendship, and the antiquity of these trees. To my worthy friends Osgood Hanbury and his son, I recommend their care and protection. P. Collinson.'" (*Ibid.*, p. 572.)

Cedrus Libani in the Environs of London. At Syon is the tree already mentioned, and another (var. glauca), which is 77 ft. high, diameter of the trunk 5 ft. 6 in., and of the head 57 ft. This is a fine upright tree, with a different character from the first. At Mount Grove, Hampstead, it is 65 ft. high, the diameter of the trunk 3 ft. 6 in., and of the head 68 ft. At Whitton Place, Twickenham, there are many large cedars, one of which is 75 ft. high, with a trunk 5 ft. in diameter. At Pope's Villa, it is 85 ft. high, with a trunk 4 ft. in diameter. At Kenwood, Hampstead, 90 years planted, it is 90 ft. high, the diameter of the trunk 4 ft. 6 in., and of the head 40 ft. At Ham House, it is 42 ft. high, the diameter of the trunk 3 ft. 6 in., and of the head 73 ft.; another has a trunk 4 ft. 4 in. in diameter at 5 ft. from the ground. At Gunnersbury Park, it is 69 ft. high, the diameter of the trunk 5 ft. 6 in., and of the head 86 ft.; and there are many other fine specimens. At Charlton, it is 55 ft. high, diameter of the trunk 4 ft. At Stamford Hill, it is 63 ft. high, diameter of the trunk 5 ft. 6 in., and of the head 109 ft. At Hanwell is one with a trunk 5 ft. 4 in. in diameter.

Cedrus Libani South of London. In Devonshire, at Luscombe, 30 years planted, it is 47 ft. high, the diameter of the trunk 2 ft. 6 in., and of the head 40 ft.; at Haldon House, 35 years planted, it is 40 ft. high; at Endsleigh Cottage, 30 years planted, it is 35 ft. high. In Dorsetshire, at Melbury Park, 10 years planted, it is 28 ft. high. In Hampshire, at Strathfieldsaye, it is 106 ft. high, the diameter of the trunk 3 ft., and of the head 74 ft.; at Farnham, 50 years planted, it is 70 ft. high, the diameter of the trunk 4 ft., and of the head 75 ft.; at Testwood, 70 years planted, it is 51 ft. high, the diameter of the trunk 3 ft. 6 in., and of the head 44 ft. In Somersetshire, at Leigh Court, 14 years planted, it is 30 ft. high; at Nettlecombe, 64 years planted, it is 37 ft. high, the diameter of the trunk 3 ft. 6 in., and of the head 61 ft.; at Crowcombe Court are two remarkably fine specimens, from 50 ft. to 70 ft. high, the diameter of their trunks 6 ft., and of their heads 80 ft. to 90 ft. In Surrey, at Bagshot Park, 22 years planted, it is 25 ft. high; at St. Ann's Hill, it is 50 ft. high, the diameter of the trunk 3 ft. 6 in., and of the head 72 ft.; this tree was planted, about 1794, by the Honourable Mrs. Fox; at Claremont, in front of the house, it is 100 ft. high, with a trunk 5 ft. 4 in. in diameter; and another in the park is 100 ft. high; at Ockham Park, 34 years planted, it is 45 ft. high, the diameter of the trunk 2 ft. 6 in., and of the head 36 ft.; at Walton on Thames, 60 years planted, it is 63 ft. high, with a head 60 ft. in diameter; at Deepdene, 9 years planted, it is 16 ft. high. In Sussex, at Goodwood Park, are 139 cedars, the highest of which is between 60 ft. and 70 ft.; they are all on this dry soil on chalk; at Cowdrey, it is 60 ft. high, with a trunk 4 ft. 6 in. in diameter; at Kidbrooke, 25 years planted, it is 40 ft. high; at Westdean, 90 years planted, it is 64 ft. high, the diameter of the trunk 4 ft., and of the head 80 ft.; at Slaugham Park, 10 years planted, it is 16 ft. high. In Wiltshire, at Bowood, 50 years planted, it is 60 ft. high, the diameter of the trunk 3 ft. 6 in., and of the head 62 ft.; at Wilton House are several large cedars, 170 years old, one of which has a trunk 8 ft. 8 in. in diameter at 1 ft. from the ground.

Cedrus Libani North of London. In Bedfordshire, at Woburn Abbey, are many fine cedars, nine of which are noble trees, varying from 62 ft. to 84 ft. in height, and their trunks from 4 ft. to nearly 6 ft. in diameter; at Amphill is a cedar 85 years planted, which is 55 ft. high, the diameter of the trunk 4 ft. 6 in., and of the head 80 ft.; at Flitwick, 19 years planted, it is 30 ft. high, with a trunk 1 ft. 1 in. in diameter; at Southill, 70 years planted, it is 50 ft. high, the diameter of the trunk 3 ft., and of the head 45 ft. In Berkshire, at High Clere, are several fine cedars; the two oldest were raised in 1739, from a cone brought from Lebanon by Dr. Pococke, in 1738, and they were removed to their present situation when 30 years old; and the largest was raised from a cone borne by the Wilton cedars, in 1772; at Bear Wood, 10 years planted, it is 15 ft. high; at Ditton Park, 90 years planted, it is 80 ft. high, with a trunk 5 ft. in diameter; at White Knights, 75 years planted, it is 50 ft. high, the diameter of the trunk 2 ft. 6 in., and of the head 60 ft. In Buckinghamshire, at Temple House, 40 years planted, it is 45 ft. high, the diameter of the trunk 2 ft. 6 in., and of the head 53 ft.; at Beaconsfield, planted by Waller the poet, 80 ft. high, with a trunk 2 ft. 6 in. in diameter. In Cambridgeshire, at Oamlingey, 112 years old, it is 60 ft. high, the diameter of the trunk 3 ft. 9 in. In Cardiganshire, at Hafod, 40 years planted, it is 32 ft. 6 in. high, diameter of the trunk 1 ft. 2 in. In Cheshire, at Kinnel Park, 50 years planted, it is 30 ft. high; at Eaton Hall, 13 years planted, it is 16 ft. high. In Caermarthenshire, at Golden Grove, it is 50 ft. high. In Den-

highshire, at Llanbede Hall, 14 years planted, it is 18 ft. high. In Derbyshire, at Hassop, it is 24 ft. high; at Elvaston Castle, it is 73 ft. high, the diameter of the trunk 4 ft. 8 in., and of the head 76 ft. In Durham, at Southend, 28 years planted, it is 30 ft. high. In Essex, at Audley End, 72 years old, it is 60 ft. high, the diameter of the trunk 4 ft., and of the head 73 ft.; at Hylands, 10 years planted, it is 26 ft. high; at Faulkbourne Hall, it is 80 ft. high, the diameter of the trunk 6 ft. 6 in., and of the head 100 ft.; at Thorndon Hall, it is 40 ft. high, with a trunk 4 ft. in diameter; at Short Grove is a remarkable cedar, 80 ft. high, with a trunk 4 ft. 4 in. in diameter at 1 ft. from the ground. About 13 ft. from the ground is a large limb, very nearly the size of the trunk; and a small branch from this limb grows, or is inoculated into the trunk. There are 68 cedars on this estate. In Gloucestershire, at Dodington Park, 35 years planted, it is 30 ft. high, the diameter of the trunk 1 ft. 6 in., and of the head 60 ft. In Herefordshire, at Eastnor Castle, 18 years planted, it is 30 ft. high; at Hatfield, 13 years planted, it is 25 ft. high. In Hertfordshire, at Aldenham Abbey, 34 years planted, it is 50 ft. high, the diameter of the trunk 2 ft., and of the head 30 ft.; at Cashobury, 30 years planted, it is 45 ft. high, the diameter of the trunk 2 ft., and of the head 42 ft.; at Cheshunt, 20 years planted, it is 22 ft. high. In Lancashire, at Latham House, 30 years planted, it is 23 ft. high. In Leicestershire, at Quenby Hall, a cedar supposed to be among the first planted in England, the seeds of which were brought from the Levant by Mr. William Ashby, a Turkey merchant, between 1680 and 1690 (see *Gard. Mag.*, vol. vii. p. 423); at Whetton House, 30 years planted, it is 36 ft. high, the diameter of the trunk 2 ft. 2 in., and of the head 48 ft.; at Donnington Park, 80 years planted, it is 62 ft. high, the diameter of the trunk 8 ft. 6 in., and of the head 68 ft. In Lincolnshire, at Scryveling, there are many fine cedars of different varieties, and of great age and size. In Northumberland, at Woolington, 20 years planted, it is 20 ft. high. In Norfolk, at Merton, is a cedar 78 ft. high, with a trunk nearly 4 ft. in diameter. In Nottinghamshire, at Clumber Park, var. *glauca* is 80 ft. high, the diameter of the trunk 3 ft. 11 in., and of the head 44 ft.; at Workop Manor, it is 64 ft. high, the diameter of the trunk 4 ft., and of the head 63 ft.; another, 100 years old, is 65 ft. high, the diameter of the trunk 5 ft., and of the head 61 ft. In Northamptonshire, at Castle Ashby, one 80 years old is 73 ft. high, with a trunk nearly 5 ft. in diameter, and a conical well-shaped head; another, 68 ft. 7 in. high, has a trunk about the same size; at Wakefield Lodge, 90 years planted, it is 25 ft. high. In Oxfordshire, at Oxford, in the Botanic Garden, 40 years planted, it is 30 ft. high, the diameter of the trunk 1 ft. 3 in., and of the head 27 ft. In Pembrokeshire, at Stackpole Court, 35 years planted, it is 38 ft. high, the diameter of the trunk 2 ft. 8 in., and of the head 51 ft. In Rutlandshire, at Belvoir Castle, 28 years planted, it is 30 ft. high. In Shropshire, at Hardwicke Grange, 10 years planted, it is 19 ft. high; at Willey Park, 19 years planted, it is 26 ft. high; another, 15 years planted, is 38 ft. high; at Kinlet, it is 27 ft. high, the diameter of the trunk 2 ft., and of the head 26 ft. In Staffordshire, at Trentham, it is 60 ft. high, the diameter of the trunk 4 ft., and of the head 50 ft.; at Blithfield, 48 years planted, it is 52 ft. high, the diameter of the trunk 1 ft. 6 in., and of the head 36 ft.; at Teddesley Park, 14 years planted, it is 26 ft. high; at Rolleston Hall, 30 years planted, it is 25 ft. high; at Wrottesley House, it is 60 ft. high, the diameter of the trunk 2 ft. 6 in., and of the head 42 ft. In Suffolk, on the lawn at Hardwicke, it is 50 ft. high, the diameter of the trunk 5 ft., and of the head 43 ft.; at Finborough Hall, 80 years planted, it is 80 ft. the diameter of the trunk 4 ft. 3 in., and of the head 80 ft.; at Stretton Parsonage, there is one 30 years old, with a trunk 5 ft. in diameter; at Wolveston Hall, it is 65 ft. high, the diameter of the trunk 4 ft. 6 in., and of the head 80 ft.; at Campsey Ash is a group of 8 or 10, with trunks from 4 ft. to 6 ft. in diameter; at Ampston Hall, is one with a trunk 5 ft. in diameter, and the diameter of the head 90 ft. In Warwickshire, at Combe Abbey, it is 47 ft. high, the diameter of the trunk 4 ft., and of the head 80 ft. In Worcestershire, at Hagley, is one with a trunk 5 ft. 4 in. in diameter, and the diameter of the head 85 ft.; at Croome, 80 years planted, it is 100 ft. high, the diameter of the trunk 5 ft., and of the head 120 ft. In Yorkshire, at Hackness, 12 years planted, it is 11 ft. high; at Grimston, 13 years planted, it is 12 ft. high.

Cedrus Libani in Scotland. In the Experimental Garden at Inverleith, 10 years planted, it is 10 ft. high; at Gosford House, 30 years planted, it is 20 ft. high; at Beil, 110 years old, it is 54 ft. 6 in. high, the diameter of the trunk 4 ft. 7 in., and of the head 67 ft.; at Hopetoun House, 96 years planted, it is 68 ft. high, the diameter of the trunk 4 ft. 6 in., and of the head 81 ft.; at Ratho are many fine cedars, with trunks from 3 ft. to 5 ft. in diameter. In Ayrshire, at Loudon Castle, it is 30 ft. high, with a trunk 4 ft. in diameter. In Berwickshire, at the Hirsell, 30 years planted, it is 23 ft. high. In Kirkcudbright, at Cassinacrie, it is 50 ft. high, the diameter of the trunk 3 ft. In Haddingtonshire, at Tyingname, 24 years planted, it is 27 ft. high, the diameter of the trunk 1 ft., and of the head 27 ft. In Aberdeenshire, at Thainston, 20 years planted, it is 9 ft. high. In Argyllshire, at Toward Castle, 15 years planted, it is 13 ft. high; at Roseneath Castle, 45 ft. high, the diameter of the trunk 2 ft. 6 in. In Bute, at Mount Stewart, 12 years planted, it is 13 ft. high. In Banffshire, at Gordon Castle, it is 33 ft. high, with a trunk 1 ft. in diameter; at Huntley Lodge, 10 years planted, it is 14 ft. high; at Cullen House, it is 44 ft. high, the diameter of the trunk 2 ft., and of the head 44 ft. In Fifeshire, at Danbristle Park, 12 years planted, it is 12 ft. high. In Forfarshire, at Gray House, it is 60 ft. high, the diameter of the trunk 5 ft. 6 in., and of the head 65 ft.; at Invergowrie is one with a trunk 4 ft. in diameter. In Perthshire, at Taymouth, 40 years planted, it is 36 ft. high, the diameter of the trunk 1 ft. 6 in., and of the head 20 ft.; at Perth, in the nursery of Messrs. Dickson and Turnbull, 15 years planted, it is 19 ft. high. In Ross-shire, at Brahan Castle, 50 years planted, it is 40 ft. high, the diameter of the trunk 2 ft., and of the head 36 ft. In Strathmore, at Blair Drummond, 50 years planted, it is 45 ft. high, diameter of the trunk 1 ft. 6 in., and of the head 25 ft.; at Airthrey, 36 years planted, it is 36 ft. high, the diameter of the trunk 11 in., and of the head 19 ft.; at Callender Park, 15 years planted, it is 21 ft. in height.

Cedrus Libani in Ireland. In the Glasnevin Botanic Garden, 35 years planted, it is 24 ft. high, the diameter of the trunk 2 ft., and of the head 27 ft.; at Cypress Grove is a cedar of dwarfish growth, 10 ft. high, and covering a space 6 ft. in diameter; at Terenure, 20 years planted, it is 18 ft. high; at Glasnevin is a fine specimen, with a trunk 2 ft. 8 in. in diameter, and clear to the height of 20 ft.; at Colonel Conolly's, Castletown, it is 28 ft. high, the diameter of the trunk 2 ft. 6 in., and of the head 50 ft. In Antrim, at Antrim Castle, 10 years planted, it is 17 ft. high. In Fermanagh, at Florence Court, 35 years planted, it is 36 ft. high, the diameter of the trunk 2 ft., and of the head 30 ft. In Louth, at Oriel Temple, 35 years planted, it is 33 ft. high, the diameter of the trunk 1 ft. 8 in., and of the head 28 ft.

Cedrus Libani in Foreign Countries. In France, in the Jardin des Plantes, 100 years old, it is 80 ft. high, the diameter of the trunk 3 ft. 6 in., and of the head 85 ft.; at Fromout, 22 years planted, it is 56 ft. high, the diameter of the trunk 1 ft. 6 in., and of the head 96 ft., in the Botanic Garden at Toulon, 18 years planted, it is 22 ft. high; at Barres, 28 years planted, it is 28 ft. high; at Nantes, in the nursery of M. Nerrières, 40 years planted, it is 50 ft. high, with a trunk 4 ft. in diameter; in the Botanic Garden at Avranches, 24 years planted, it is 40 ft. high. In Germany, it will not stand out

described to have been which was used in the construction of Solomon's Temple. The principal difficulty, with reference to its being the cedar of Holy Writ, is, that it has never been found on, or near, Mount Lebanon. It is regarded by the Hindoos as a sacred tree, and is called by them *Devadera*, or the Tree of God. In some places it is highly venerated, and

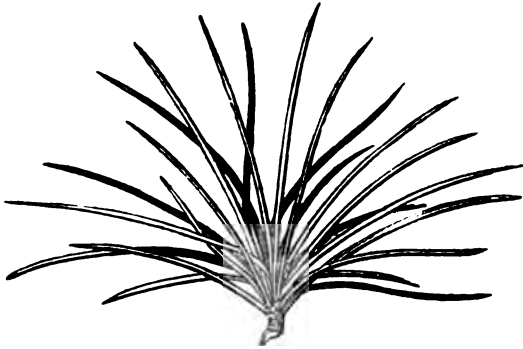

2986

never used but to burn as incense on occasions of great ceremony; but, in others, it is employed for building houses, &c., as a valuable timber tree. Mr. Moorcroft, in his *Journal*, as quoted in Lambert's *Pinus*, gives the following proofs of the durability of the wood of this tree:—"A few years ago a building erected by the order of the Emperor Akbar was taken down, and its timber (which was that of the deodar) was found so little impaired as to be fit to be employed in a house built by Rajah Shah. Granting that the former edifice was constructed at the same time as the fort of Nagurunger, A. H. 1006, or A. D. 1597, its age must have been 225 years. Zenool Abudeen began to reign over Kashmir A. H. 820, or A. D. 1417; and died A. H. 878, or A. D. 1473. His mother was interred in a domed building of excellent brick and mortar work, reported to have been erected in the time of the Hindoo sovereigns. In this building, pieces of deodar were inserted in the walls, by way, apparently, of strengthening the bond; and their ends or sides were left on the same plane with the brickwork. The window frames were of the same material, with the difference, however, of the former being squared and deprived of their sap wood, whilst the latter, somewhat carelessly, had part of the sap wood left; and the surface was only slightly smoothed, and partly retained its original form. In the latter instance, the crust of the wood was generally somewhat crumbly, and had been pierced by a worm about $\frac{1}{2}$ in. in depth; whilst that of the squared wood, exposed much more to the influence of the weather, was neither crumbly nor wormeaten, but was jagged, from the softer part of the wood, between the plates or ribs, having been often washed by the rain, though its structure had not been attacked by the worm."

The tree alluded to in the following extract from a letter from Bishop Heber to Lord Grenville appears evidently to have been the deodara. The bishop, speaking of a visit which he paid to the Himalayan Mountains, and of the pines which he found there, adds:—"Another, and of less frequent occurrence, is a splendid tree, with gigantic arms and dark narrow leaves, which is accounted sacred, and chiefly seen in the neighbourhood of ancient Hindoo temples, and which struck my unscientific eye as very nearly resembling the cedar of Lebanon. I found it flourishing at nearly 9000 ft. above the level of the sea, and where the frost was as severe at night as is usually met with at the same season (November and December) in England." In Burnes's *Travels in the Mysoore*, he states that "the frameworks of the houses are made of deodara cedar, which is floated down with the inundations of the river Schem, or Hydaspes, from the Himalaya. The durability and fragrance of the wood recommend it for buildings of every description. We saw a cedar tree," he continues, "lying on the banks of the Hydaspes, with a circumference of 13 ft. On this river the Macedonians constructed the fleet by which they navigated the Indus; and it is a remarkable fact, that in none of the Punjab

rivers are such trees floated down, nor do there exist anywhere else such facilities for the construction of vessels." (*Travels, &c.*, vol. i. p. 50.) The cedars which Victor Jacquemont found on the Himalayas and on the mountains of Cashmere, at 5360 ft. above the level of the sea (see *Corresp., &c.*, vol. i. p. 291., and vol. ii. p. 74.), were, doubtless, this species, and not cedars of Lebanon.

Properties and Uses. The wood of the *Cedrus Deodara* possesses, as we have before observed (p. 2429.), all the qualities attributed by the ancients to that of *C. Libani*. It is very compact and resinous, and has a fine, fragrant, refreshing smell, like that felt when walking in pine groves towards evening, or in moist weather; and very different from that of the cedar of Lebanon. Its wood has a remarkably fine close grain, capable of receiving a very high polish; so much so, indeed, that a table formed of the section of a trunk nearly 4 ft. in diameter, sent by Dr. Wallich to Mr. Lambert, has been compared to a slab of brown agate. Dr. Royle informs us that the wood is particularly valued for its durability, and is much used in the construction of Himalayan houses. In Cashmere, according to Mr. Moorcroft (*Lamb. Pin.*, ii. p. 94.), it is used for buildings, both public and private, and for bridges and boats. Strips of it are also employed for candles. Dr. Lindley states that "Mr. Moorcroft procured specimens from the starlings of the Zein ool Kuddul bridge in Ladakh, where it had been exposed to the water for nearly 400 years." (*Penn. Cyc.*) The following extract is from a letter from the Honourable W. Leslie Melville to the secretary of the Highland Society of Scotland, dated Calcutta, January, 1836, and printed in Lawson's *Manual*:—"The timber is employed for roofing, and other purposes; and, if sheltered from the weather, is very durable. It is found perfectly sound in the roofs of temples which cannot have stood less than 200 years. For out of door purposes, I understand it requires paint, which, however, perfectly protects it."

The turpentine from this tree, Dr. Royle informs us, is very fluid, and, though coarse, is much valued in Upper India for medical purposes; the leaves and twigs are also used by the natives in medicine; and tar and pitch are procured from the trunk.

In England, the specimens of it are at present small; but the feathery lightness of its spreading branches, and the beautiful glaucous hue of its leaves, render it, even when young, one of the most ornamental of the coniferous trees; and all the travellers who have seen it full grown agree that it unites an extraordinary degree of majesty and grandeur with its beauty. The tree thrives in every part of Great Britain where it has been tried, even as far north as Aberdeen; where, as in many other places, it is found hardier than the cedar of Lebanon. It is readily propagated by seeds, which preserve their vitality when imported in the cones, but scarcely otherwise. It also grows freely by cuttings, which appear to make as handsome free-growing plants as those raised from seed. It has been inarched on the larch; but the latter tree being deciduous, it may be doubtful whether plants so propagated will attain a large size, and be of great duration. It has been grafted in the wedge manner on the common cedar, in considerable numbers, by Mr. Barrow, gardener to the Earl of Harrington, at Elvaston Castle. Mr. Barrow has given a detailed account of his process, and of the success which attended it in *Gard. Mag.*, vol. xiv. p. 80. The nursery culture, and the soil and situation in which it is to be finally planted, may be considered in all respects the same as those of the common cedar.

Statistics. In the neighbourhood of London, in the Horticultural Society's Garden, 7 years planted, it is 8 ft. high; at Kew, it is 3 ft. high; at the Duke of Devonshire's villa, at Chiswick, it is 3 ft. high; at Hendon Rectory, it is 3 ft. 6 in. high. In Bedfordshire, at Flitwick, it is 2 ft. high. In Berkshire, at Droptmore, it is upwards of 6 ft. high: it was sown in March, 1831, and planted out in the autumn of the same year. In Derbyshire, at Chatsworth, it is 3 ft. 8 in. high. In Devonshire, at Bicton, it is 4 ft. high. In Kent, at Redleaf, it is 6 ft. high. In Wiltshire, at Boyton, it is 3 ft. high.—In Scotland, in the Experimental Garden, it is 4 ft. 6 in. high. In Aberdeenshire, in Roy's Nursery, it is 1 ft. 6 in. high. In Fifehire, at Lahill, it is 3 ft. high.—In Ireland, there are plants in the Trinity College Botanic Garden, in the Glasnevin Garden, and at Titouur, near Mount Kennedy. In Paris, there are plants in the nursery of M. Daniell, on the Boulevard Mont Parnasse. In Germany, it is in the Berlin Botanic Garden, and in the Flötbeck Nurseries.

Commercial Statistics. The price of plants, in the London nurseries, is two guineas each.

GENUS VI.



ARAUCARIA Ruiz et Pav. THE ARAUCARIA. *Lin. Syst. Dic'cia* Monadélphia.

Synonymes. *Eutassa Sal.*, *Colymba Sal.*, *Dombèys Lamb.*, *Cupressus Forst.*, the Southern Pine.

Derivation. From *Araucanos*, the name of the people in whose country *Araucaria imbricata* grows in Chili.

Description, &c. Magnificent evergreen trees, natives of South America, Polynesia, and Australia; one of them, the *Araucaria imbricata*, as hardy in the climate of Britain as the cedar of Lebanon.

♀ 1. A. IMBRICATA Pav. The imbricate-leaved Araucaria, or Chili Pine.

Identification. Pav. Diss. in *Mém. Acad. Reg. Méd. Mat.*, 1. p. 197.; Willd. Sp. Pl., 4. p. 880.; Ait. Hort. Kew., 5. p. 412.; Lamb. Pin., ed. 2., No. 52.; Laws. Man., p. 308.

Synonymes. *A. Dombeyi* Rich. *Mém. sur les Conif.*, p. 88.; Lindl. in *Penn. Cyc.*; *Pinus Araucaria Mol. Sag. sulla Stor. Nat. del Chili*, p. 182.; *Colymba quadrifaria Seisid. in Laws. Trans.*, 8. p. 315.; *Dombèys chilénsis Lam. Encyc.*; *Pino de Chili, Span.*; *Peghuen in the Andes*; *Sir Joseph Banks's Pine*.

The Seeds. There is a tree at Kew which bore female catkins in 1836; and a male plant at Beyton, which blossomed in the same year.

Engravings. Lamb. Pin., ed. 2., t. 56., and 57.; Rich. *Mém. sur les Conif.*, t. 20. and 21.; and our *figs.* 2286. to 2293. *Fig.* 2287. is a cone or female catkin in a young state, from Lambert; *fig.* 2292. is a specimen of the female tree at Kew; *fig.* 2291. is a portion of the male tree with the full-grown catkin, from Lambert's *Monograph*; and *fig.* 2288. is the full-grown female cone; all to our usual scale, that is, a sixth part of the natural size. *Fig.* 2286. is a portion of a cone of the natural size. *Fig.* 2290. *a.* is a seed with the scale and wing of the natural size, and *b.* is the kernel; and *fig.* 2289. is a leaf of the natural size.

Spec. Char. Leaves in eights, imbricated, ovate-lanceolate, with persistent mucros. (*Pav.*) A tree, growing to the height of 150 ft.; a native of the Cordilleras, in Chili. Introduced in 1796, and flowering from September to November.

Description. Flowers dioecious. — Male. Catkin dipsacus- (teasel-) shaped, ovate-cylindrical. Scales numerous, sessile, closely imbricated round a common conical axis; filament-like, obovate, somewhat woody; with an oblong reflexed point. Anthers numerous, oblong, 2-celled; connate a little below the points of the scales, afterwards dependent; free, at first adpressed to the scales, afterwards, having shed their pollen, divaricate. — Female. Catkin ovate. Scales numerous, wedge-shaped, 2-flowered. Germs wedge-shaped, compressed in the two opposite sides. Style none. Stigma 2-valved, callous, thick: exterior valve ovate-acuminate, larger, concave, with a linear inflexed point; interior smaller, somewhat linear, obtuse, erect. Pericarp: cone spherico-ovate; scales connivent, coriaceous and woody, wedge-shaped, terminated by a long awl-shaped point, 2-seeded. Seed: nut wedge-shaped, terminated at the apex by a short, callous, marginal wing, bluntly tetragonal at the base; afterwards gibbous, compressed, with opposite sides: tegument coriaceous. Nucleus of the same figure. (*Pavon Disert. in Mém. Acad. Reg. Méd. Matrit.*, i. p. 197., as quoted by Lambert.) Cone from 8 in. to 8½ in. broad, and from 7 in. to 7½ in. long; seed 2½ in. long, and ½ in. broad.

This is a very remarkable tree, the female of which, according to *Pavon*, is about 150 ft. high; while the male is seldom more than 40 ft. or 50 ft. high. The trunk is quite straight, and without knots, with a strong arrow-like leading shoot, pushing upwards. It is covered with double bark, the inner part of which, in old trees, is 5 in. or 6 in. thick; fungous, tenacious, porous, and light; and from it, as from almost every other part of the tree, resin flows in great abundance: the outer bark is of nearly equal thickness, resembling cork

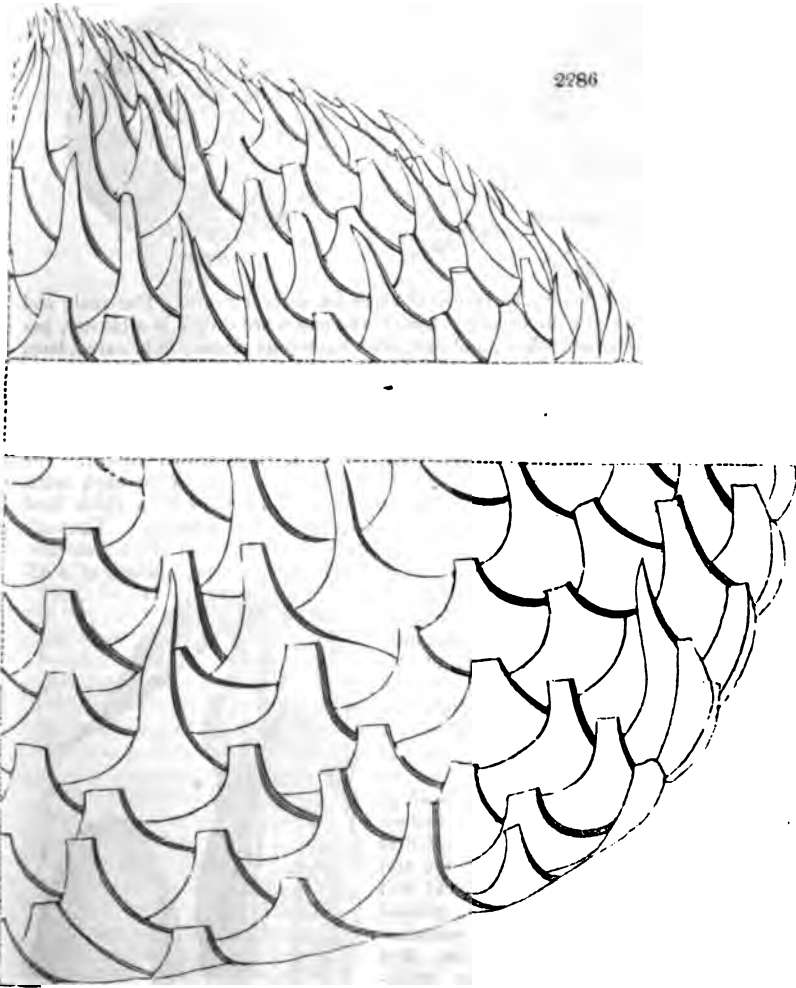

cleft in different directions, and equally resinous with the inner bark. In young trees, the bark of the trunk is studded with leaves from the base of the tree upwards, which remain attached for 12 or 15 years. The branches are produced in whorls of 6, 7, and sometimes 8, in a whorl, the greater number being nearest the ground; and the branches diminish in length as they ascend higher up the tree, till at the top they terminate in a kind of pyramidal head. They are horizontal, inflexed, and ascending at the extremities. These large horizontal arms, clothed with closely imbricated leaves, resemble, in young trees, snakes partly coiled round the trunk, and stretching forth their long slender bodies in quest of prey. The leaves are sessile, somewhat thickened at the base, ovate-lanceolate, stiff, straight, somewhat keel-shaped below, and strongly mucronate at the apex; verticillate, with 7 or 8 in a whorl; imbricate, and closely encircling the branches; concave, rigid, glabrous, shining, marked with longitudinal lines, dotted on both sides; leathery, with a cartilaginous

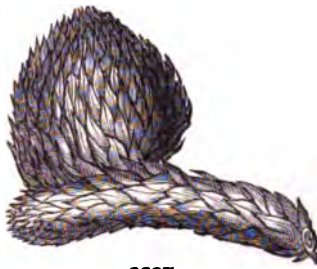

2287

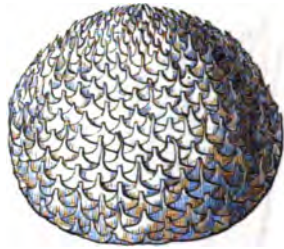

2288

margin, and remaining attached to the tree for several years. The male and female catkins are on separate trees: the males are 6 or 7 in a cluster, pedunculate, terminal, yellow, and oval, with numerous scales; imbricated, long, and recurved at the points: the female catkins are oval, with numerous imbricated wedge-shaped scales, with narrowed oblong brittle points; and they are produced at the ends of the branches, where they look at first sight like an unnatural thickening of the leaves. The cones, when fully ripe, are globular, from 3 in. to 4 in. in diameter, and of a dark brown colour. The scales are deciduous, and easily detached. The seeds are 2 to each scale, wedge-shaped, and very large, being more than 1 in. long, with a thick hard shell surrounding an eatable kernel: wings short and obsolete. The male tree has its leaves somewhat differently shaped from those of the female tree, and very much resembling those of *A. brasiliana* in shape, though of a different texture and colour. The following interesting description of this remarkable tree is from Pœppig's *Travels in the Peruvian Andes*, as quoted in the *Companion to the Botanical Magazine*:—"When we arrived at the first araucarias, the sun had just set: still some time remained for their examination. What first struck our attention were, the thick



2289

roots of these trees,

which lie spread over the stony and nearly naked soil, like gigantic serpents, 2 ft. or 3 ft. in thickness: they are clothed with a rough bark, similar to that which invests the lofty pillar-like trunks of from 50 ft. to 100 ft. in height.

The crown of foliage occupies only about the upper quarter of the stem, and resembles a large depressed cone. The lower branches, eight or twelve in number, form a circle round the trunk: they diminish till they are but four or six in a ring, and are of most regular formation, all spreading out horizontally, and bending upwards only at their tips. They are thickly invested with leaves that cover them like scales, and are sharp-pointed, above an inch broad, and of such a hard and woody texture, that it requires a sharp knife to sever them

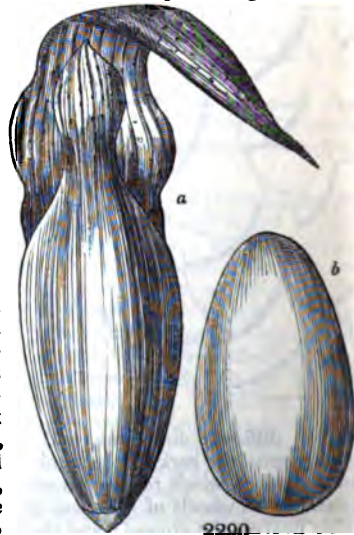

2290

from the parent branch. The general aspect of the araucaria is most striking and peculiar, though it undeniably bears a distant



2291



2292

family likeness to the pines of our country. The fruit, placed at the ends of the boughs, are of regular globular form, as large as a man's head; and each consists of beautifully imbricated scales, that cover the seeds, which are the most important part of this truly noble tree." (*Comp. Bot. Mag.*, i. p. 351.) "The wood of the araucaria is red where it has been affected by the forest fires; but otherwise it is white, and, towards the centre of the stem, bright yellow. It yields to none in hardness and solidity, and might prove valuable for many uses, if the places of growth of the tree were less inaccessible. For ship-building it would be useful; but it is much too heavy for masts. If a branch be scratched, or the scales of an unripe fruit be broken, a thick milky juice immediately exudes, that soon changes to a yellowish resin, of which the smell is agreeable, and which is considered by the Chilians as possessing such medicinal virtues, that it cures the most violent rheumatic headaches when applied to the spot where the pain is felt." (*Ibid.*) country very little is stated by

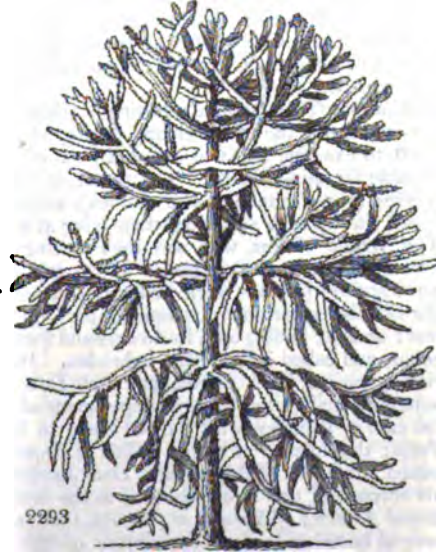

2293

Of the rate of growth of this tree in its native travellers It is probably slow, as appears to

be the case with plants in the climate of London; though scarcely any of these have yet had full justice done to them. The largest specimen in Europe, which is that at Kew, and of which *fig.* 2293. is a portrait taken in 1836, was then 12 ft. high, after having been above 40 years planted; but young plants, established in the open ground at Dropmore, make shoots, occasionally, of above a foot in length. It may be remarked of the araucaria in Britain, that young plants sometimes remain a whole year without making any shoot whatever; and that, at other times, the same plants require two years to produce one shoot; that is, the shoot continues slowly increasing in length, from the midsummer of one year to that of the year following.

Geography. The araucaria is a native of South America, in a part of the Andes inhabited by the Araucanians, a people who are said by Molina to pride themselves on their name, its signification being frank, or free. (See *Molina's History of Chili, &c.*) The tree is found in large forests on the mountains Caramavida and Naguelbuta, in Chili, belonging to the Llanista, Peghuen, and Araucano Indians. This chain, or Cordillera, of the Andes, says Pavon, as quoted by Mr. Lambert, "offers to the view, in general, a rocky soil, though in parts wet and boggy, on account of the abundance of rain and snow which falls in these regions, similar to many provinces in Spain." It is also found in the neighbourhood of Concepcion, in Chili. Pœppig says:—"The araucaria forest of Antuco is the most northerly that is known in Chili; so that the northern boundary of this king of all the extra-tropical American trees may be estimated at 36° south latitude. The extreme southern limit is not so clearly ascertained; which is not surprising, when we consider how little, comparatively, is known of Western Patagonia: it seems probable, however, that it does not stretch far beyond lat. 46°. Between Antuco and Valdivia, this tree only grows among the Andes, and, as the Indians assert, solely on their western declivities, and nowhere lower than from 1500 ft. to 2000 ft. below the snow line, up to which they frequently reach. Further to the south, the araucaria appears at a lower elevation; and, in the country of the Cuncos, and about Osorno, is said to occur on mountains of a very moderate altitude, near the sea. The Corcovado, a mountain that rises opposite Chilöe, is said to be studded, from its foot to the snow line, with large groups of these beautiful trees. Of all other vegetation, the araucarian forests are as bare as the pine woods, offering but few plants which can interest the botanist. Steep rocky ridges, where there is no water, are its favourite habitat." (*Pœpp.* in *Comp. Bot. Mag.*)

History. The Spaniards, having settlements in the immediate vicinity of the country of the Araucanians, employed Don Francisco Dendariarena, in 1780, to examine the trees, with a view of discovering if any of them were suitable for ship-building. The result of his experiments was to select this species (the Peghuen of the natives), which was accordingly made use of to repair the Spanish squadron, then lying at anchor in the port of Talcahuano. The Abbate Molina, who was then writing his *Civil and Natural History of Chili* (published at Bologna in 1782) supposed the tree to be a *Pinus*; and he described it in his work under the name of *Pinus Araucana*. In 1782, the Spanish government commissioned Don Joseph Pavon to search for this tree; and he, finding both its flowers and fruit, ascertained that it was a distinct genus, and called it *Araucaria imbricata*. Don Joseph Pavon (who had previously visited Chili, in company with Don Hippolito Ruiz and the French botanist Dombey, in 1777,) sent specimens of *Araucaria imbricata* to France, to the care of Dombey, who showed them to MM. Lamarck and De Jussieu, in Paris; the former of whom called it *Dombeya chilensis*, while Jussieu retained the name of *Araucaria*. Don Joseph Pavon, however, complains, in his account of this tree, published in the first volume of the *Memoirs of the Royal Academy of Sciences at Madrid*, that both Jussieu and Lamarck made several mistakes in their description of the botanical characteristics of the species, which had been avoided by both Molina and himself. In 1795, Captain Vancouver touched at the coast of Chili; and Mr. Menzies, who

accompanied the expedition, procured cones, seeds from which he sowed on board the ship, and brought home living plants, which he presented to Sir Joseph Banks, who planted one of them in his own garden at Spring Grove, and sent the others to Kew. From this circumstance, the tree was called at first, in England, Sir Joseph Banks's pine. The tree at Kew was kept in the green-house till about 1806 or 1808, when it was planted out where it now stands, by Mr. M'Nab, the present superintendent of the Edinburgh Botanic Garden. After it was planted out, not being considered quite hardy, it was protected, during winter, with a temporary frame, covered with mats; and, having become habituated to this mode of treatment, it has been considered unsafe to leave it off. The species is, however, now found quite hardy at Dropmore, and other places; and we have no doubt that, as soon as plants can be procured from seed at a reasonable rate, it will be as generally planted as the cedar of Lebanon, or the deodar, and will be found to be quite as hardy as these trees.

The *Araucaria imbricata* was introduced into France before 1822, and was treated there as a hot-house plant. Dr. Pœppig, who introduced it into Germany, gives the following description of the difficulty which attended his procuring seeds: — "We were obliged to seek water at a considerable distance from our bivouac; but, our frugal supper not requiring much cooking, we soon stretched ourselves on the hard rock to sleep, under the lullaby of a storm, to which the lofty summits above us imparted the most singular tones. All of us who had been accustomed to such primitive beds might have rested well enough, if a fog had not descended upon us about midnight, which was so dense as nearly to extinguish our fire. Matters became still worse, when violent thunder and hail apprised us that not even a forest of araucarias could shelter the traveller from the wrath of the Cordillera. We all trembled; my companions, however, chiefly from fear and superstition; though the temperature was sufficiently low to occasion a shudder in thinly clad travellers. The anxiously looked-for morning brought a brighter sky, and the means of kindling a cheerful and genial fire. A young man, who had joined us the preceding day, succeeded (by means of his lasso, which he threw over one of the lowest branches) in ascending a tree, from which he brought down many branches, loaded with their truly colossal fruit, which have since arrived safely in Germany." (*Pœppig's Travels in the Peruvian Andes*, as quoted in *Comp. Bot. Mag.*, vol. i. p. 355.) "The reason," he adds, "why many of the seeds of the araucaria that have been sent to Europe did not vegetate is, because the collectors did not procure them from the Indian country, but bought them in the market at Valparaiso, where they are offered for sale boiled and dried. My excursion to Quillay-Leuvu obtained for me fresh seeds of the araucaria, which reached Germany in October, 1829, being seven months after they were ripe; and, being sowed immediately, the period was just that of the Chilian spring. Of some hundreds, about 30 came up; but ignorance of the true climate, which led to the error of placing the young plants in a hot-house, killed the greater part during the first year. To my great satisfaction, however, about six individual plants have been preserved in different places. The specimen in the Botanic Garden at Leipzig flourishes beautifully: it is (? 1832) about 1 ft. 8 in. high, and already bears four long branches in whorls." (*Ibid.*)

Properties and Uses. Don Joseph Pavon describes the wood of this tree as of a yellowish white, fibrous, and full of beautiful veins, capable of being polished and worked with facility. He also states that it is well adapted for ship-building, as was proved by the experiments of Don Franciaco Dendarriarena, in 1780. The resin, abounding in all parts of the tree, is white: its smell is like that of frankincense, and its taste not unpleasant. It is applied as a plaster to contusions, and for various medical purposes. The Indians consider the fruit as a very nourishing food: they eat it raw, as well as boiled and roasted; and they distil from it a kind of spirituous liquor. They have stated times to collect the fruit, which they preserve to make use of as

required. (See *Lamb. Pin.*, ed. 2., ii. p. 106.) Dr. Poeppig says:—"The araucaria is the palm of those Indians who inhabit the Chilean Andes, from lat. 37° to 48°; yielding to these nomade nations, a vegetable substance that is found in the greater plenty the more they recede from the whites, and the more difficult they find it to obtain corn by commerce. Such is the extent of the araucarian forests (*pinares*), and the amazing quantity of nutritious seeds that each full-grown tree produces, that the Indians are ever secure from want; and even the discord that prevails frequently among the different borders does not prevent the quiet collection of this kind of harvest. A single fruit (*cabeza*, a head,) contains between 200 and 300 kernels; and there are frequently 20 or 30 fruits on one stem; and, as even a hearty eater among the Indians, except he should be wholly deprived of every other kind of sustenance, cannot consume more than 200 nuts in a day, it is obvious that 18 araucarias will maintain a single person for a whole year. The kernel, which is of the shape of an almond, but double the size, is surrounded with a coriaceous membrane, that is easily removed; though relishing, when prepared, it is not easily digestible, and, containing but a small quantity of oil, is apt to cause disorders in the stomach with those who are not accustomed to this diet. When the scarcely matured seeds are dried in the sun, a sugary substance exudes, which appears to reside chiefly in the embryo. The Indians eat them either fresh, boiled, or roasted; and the latter mode of cooking gives them a flavour something like that of a chestnut. For winter's use, they are dried after being boiled; and the women prepare a kind of flour and pastry from them. The collecting of these fruits would be attended with great labour, if it were always necessary to climb the gigantic trunks; but, as soon as the kernels are ripe, towards the end of March, the cones drop off of themselves, and, shedding their contents on the ground, scatter liberally a boon, which nothing but the little parrot (*Psittacus choræus Mol.*), and a species of cherry finch, divide with the Indians. In the vast forests, of a day's journey in extent, that are formed by these trees in the districts of Pehuenches and Huilliches, the fruits lie in such plenty on the ground, that but a very small part of them can be consumed. In former times, a great quantity came to Concepcion and Valdivia, by trading with the Indians; and thence they found their way to Valparaiso and Lima; but now they are seldom met with any where near the coast, till they are too old to be palatable." (*Ibid.*)

Propagation, Culture, &c. The treatment of this tree, when raised from seeds, may be considered in all respects the same as that of the cedar; regard being had to the different size of the seeds, which will, of course, require a thicker covering. Plants may be raised from cuttings; and these, we have no doubt, will in time assume a leading shoot, like that of seedlings; but, as the plant has been only a short time propagated in this way, the only instance in which we are certain of this having taken place is at Dropmore; where, in consequence of all the shoots of a plant raised from a cutting, now 6 or 8 years old, having been pegged down to the ground, a vigorous erect shoot, which, in 1837, was 2 ft. high, has been protruded from the collar, and promises to make as handsome a tree as any seedling plant whatever.

Statistics. The largest specimen in the neighbourhood of London is that at Kew, which, in 1836, was 12 ft. high, having been raised from seed in 1796, and planted out in the open air in 1808. In the Horticultural Society's Garden, 8 years planted, it is 6 ft. high. In Bedfordshire, at Flitwick, 4 years planted, it is 3 ft. 5 in. high. In Berkshire, at Dropmore, are several from 8 ft. to 9 ft. high. In Hertfordshire, at Chestnut, 3 years planted, it is 3 ft. 6 in. high; at Bayfordbury, it is 4 ft. 2 in. high. In Kent, at Redleaf, it is 5 ft. high. In Lancashire, in the Manchester Botanic Garden, 2 ft. 8 in. In Northumberland, at Belsay, it is 5 ft. 1 in. high.—In Scotland, in the Experimental Garden at Inverleith, 6 years planted, it is 3 ft. high; and in the Botanic Garden, 3 ft. 6 in. high; in Lawson's Nursery, 3 years planted, it is 2 ft. 6 in. high. At Aberdeen, in Roy's Nursery, it is 3 ft. 6 in. In Stirlingshire, at Buchanan, 3 ft. high. In all these places, except Kew, it stands without the slightest protection; and, at Aberdeen, is found more hardy than the common cedar of Lebanon.—In France, in the garden of M. Brunel, at Avranches, 6 years planted, it is 11 ft. high.

Commercial Statistics. Plants, in the London nurseries, are rarely to be met with, and they are charged from 2 to 5 guineas each, according to their size.

† 2. A. BRASILI'NA Rich. The Brazil Araucaria, or Brazil Pine.

Identification. Richard in Dict. Class. d'Hist. Nat., 1. p. 152.; Mém. sur les Conif., p. 154.; Lamb. Pin., ed. 2., t. 58, 59, 60.; Lawson's Manual, p. 396.

Engravings. Lamb. Pin., ed. 2., 2. t. 58, 59, 60.; our *Figs.* 2295. and 2296. to our usual scale; and *Fig.* 2294. of the natural size.

The Sexes. It is uncertain whether both are in Britain or only one; only a male plant, at Boyton, having flowered in 1836.

Spec. Char., &c. Leaves loosely imbricated, lanceolate, mucronate, glaucous green, keeled beneath. Female catkins roundish-oval; scales recurved at

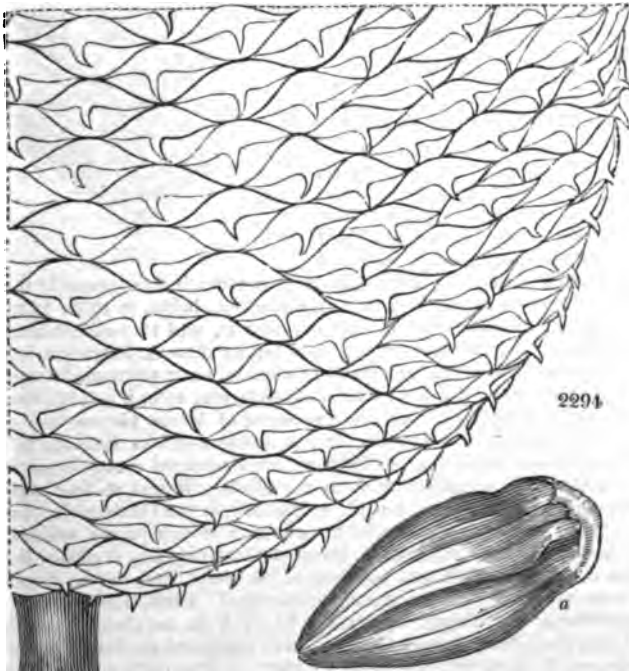

the apex. (*Lamb. Pin.*) A large tree, a native of the Brazil. Introduced in 1819, requiring protection during winter, or a green-house.

Description, &c. A tree, in general appearance and size, like *A. imbricata*; but much more loose and spreading. Branches numerous, leafy, approximate, sometimes almost verticillate; branchlets, in the young trees, flexible, spreading, twiggly, round, covered with a green smooth bark. Leaves lanceolate, mucronate, quite entire, a little cartilaginous, much more loose, and three times thinner than in *A. imbricata*; somewhat pliant, smooth; concave above, light green, and shining; beneath glaucous and keeled; 1 in. to 2 in. long, $\frac{1}{2}$ in. broad; marked on both sides, but especially on the lower, with many dotted lines; scattered on the young tree, spreading, linear-lanceolate, attenuated, 2 in. long, scarcely 2 lines broad. Male catkins not yet known. Female, roundish-ovate, solitary on the apex of the branches, sessile, similar in size and appearance to the heads of flowers of *Dipsacus sylvêstris*; scales thick, compressed, wedge-shaped-oblong, quadrangular, of a firm corky substance, closely placed together above a conico-cylindrical receptacle, each terminated by a lanceolate, acute, recurved ap-

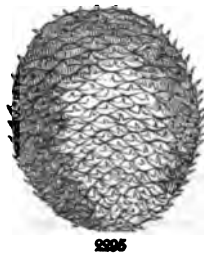

pendage, hollow within at the base of the upper side, and furnished with a young monospermous nut. Nut, in size and colour, like the preceding. (*Lamb.*) The *Araucaria brasiliãna* forms a tree from 70 ft. to 100 ft. high. It bears considerable resemblance to *A. imbricatã*; but the leaves are larger and less rigid; they are also much less closely imbricated, and are somewhat reflexed. The tree, when full grown, has a large "irregular head, with horizontal, pendulous, and aspiring branches, at the extremities of which the branchlets are collected into tufted masses. The cones are rather smaller, more compact, and harder than those of *A. imbricatã*; from which they differ in the scales being thick, and furnished with small, sharp, recurved spines on their points." *A. brasiliãna* grows much more rapidly than *A. imbricatã*; a tree at Dropmore, 10 years planted, being, in 1836, 11 ft. 6 in. high, while one of *A. imbricatã*, standing near it, and 13 years planted, was only 8 ft. high. It is, however, much more tender than *A. imbricatã*, and will not stand the winter in the climate of London without protection. According to the *Dictionnaire Classique d'Histoire Naturelle*, tom. i. p. 512., this tree forms immense forests between the provinces of Minas Geraes and Saõ Paulo, to the north of Rio Janeiro. It was introduced into England in 1819, by Mr. Lee of the Hammersmith Nursery, who received a cone from Rio de Janeiro, and raised some plants from the seeds. It was at first supposed to be the same as *A. imbricatã*, but M. A. Richard, in the *Dictionnaire Classique*, &c., published in 1822, states that he considers it a separate species, and that he has given it the name of *A. brasiliãna*; adding that it differs from *A. imbricatã* in the whiteness and softness of its wood, and in the disposition of its branches; but that its principal botanical distinction is, that it is entirely without any winged appendage to its fruit, as shown at *a* in *fig. 2294*. (See, also, *Mém. sur les Conif.*, p. 154., published in 1826; and *Lamb. Gen. Pin.*, ed. 2., ii. t. 58., published in 1832.) The nuts, which have very little resin, are sold as an article of food in the market of Rio de Janeiro; and the resin, which exudes from the trunk of the tree, is mixed with wax to make candles. Seeds are frequently sent to England; but they will seldom vegetate unless sent over in the cone. It propagates freely from cuttings; and Mr. Lambart has now several plants raised in that manner. In Britain, it can only be considered as fit for the green-house; though in the Horticultural Society, and at Dropmore, Woburn, Cheshunt, and various other places, there are plants in the open ground, from 3 ft. to 10 ft. high, which, however, are protected during winter, so as to exclude the frost. The plant in the Horticultural Society's Garden, after being 3 years planted, is 5 ft. high; that at Dropmore, the largest plant, was, in 1837, 12 ft. high.



2296

† 3. *A. EXCELSA* *Ait.* The lofty *Araucaria*, or *Norfolk Island Pine*.

Identification. *Ait.* in *Hort. Kew*, ed. 2., 5. p. 412.; *Rich. Mém. sur les Conifères*, p. 154.; *Lamb. Gen. Pin.*, ed. 2., 2. t. 61, 62.; *Lindl. in Penn. Cyc.*; *Lawson's Manual*, p. 366.

Synonymes. *Eutassa heterophylla Sal.* in *Læs. Trans.*, 8. p. 316.; *Cupressus columbãria, &c., Forst. Fl. Ins. Aust.*; *Dombeya excelsa Lamb. Monog.*, ed. 1., p. 87. t. 39, 40.; *Altingia excelsa Loud. Hort. Brit.*, p. 403.; *Pin de Norfolk, Fr.*

Engravings. *Lamb. Mon.* 3. 39, 40., *Pin.*, t. 61, 62.; and our *figs. 2297. to 2302.*

Spec. Char., &c. Adult leaves closely imbricated, bent inwards, mutic. (*Ait.*)

A lofty tree, a native of Norfolk Island and New Caledonia. Introduced in 1793; and requiring protection during winter, or to be kept in a green-house; being still more tender than *A. brasiliãna*.

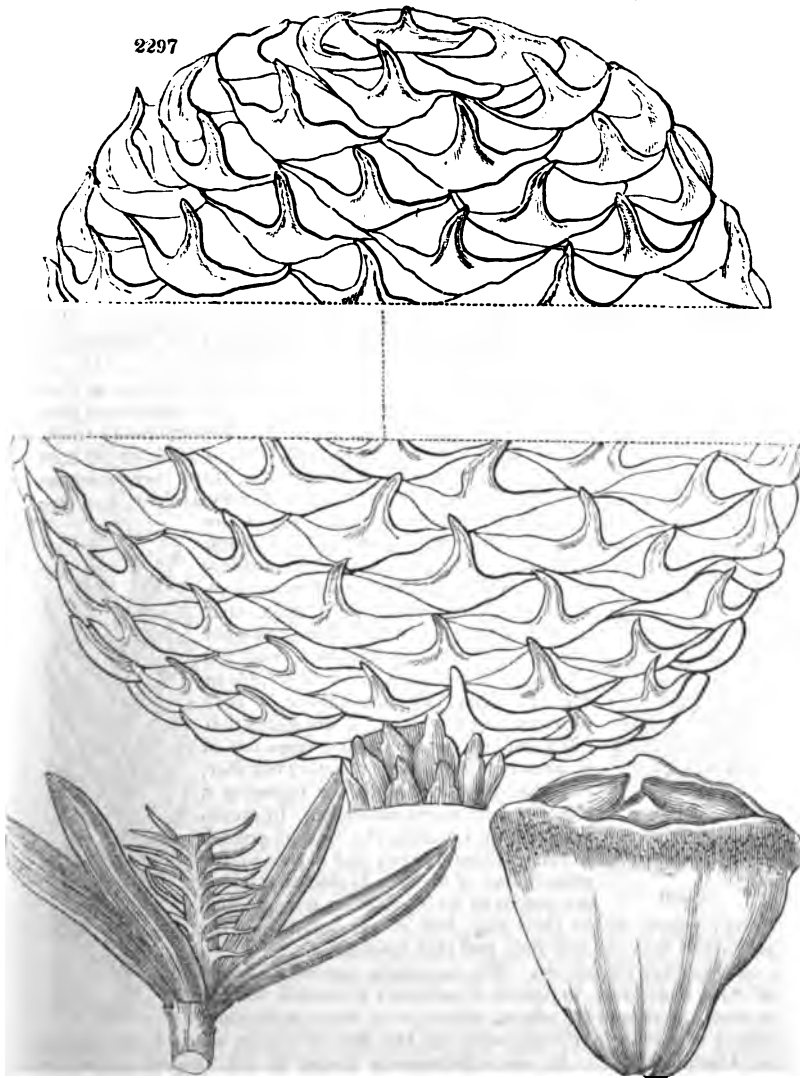

Description. A majestic tree, growing to the height of from 160 ft. to 228 ft., with a trunk sometimes 11 ft. in diameter, and free from branches to the height of 80 ft. or 100 ft. " Its trunk rises erect, and, in old trees, is sparingly covered with long, drooping, naked branches, towards the extremities of which the leaves are clustered: these latter, when the plant is young, are long, narrow, curved, sharp-pointed, and spreading, as shown in *fig. 2301.*; but, when the tree is old, they become shorter and broader, and are pressed close to the branches, as shown in *fig. 2300.* to our usual scale, and *fig. 2298.* of the natural size. (*Lindl. in Penn. Cyc.*) In consequence of this difference in the disposition of the leaves, old and young trees are so little alike, that they might

easily be mistaken for distinct species. The bark abounds in turpentine; but there is none in the wood, which is white, tough, and close-grained. Captain Cook, describing the tree when he discovered it, says: — “The wood is white, close-grained, tough, and light. Turpentine had exuded out of most of the trees, and the sun had inspissated it into a resin, which was found sticking to the trunks, and lying about the roots. These trees shoot out their branches like all other pines; with this difference, that the branches of these are much smaller and shorter, so that the knots



2298

become nothing when the tree is wrought for use. I took notice that the largest of them had the smallest and shortest branches, and were crowned, as it were, at the top by a spreading head, like a bush. This was what led some on board into the extravagant notion that they were basaltes.” (*Cook's Second Voyage*, vol. ii. p. 149., as quoted by Lambert.) In Captain Hunter's *Journal of the Transactions at Port Jackson and Norfolk Island*, also quoted by Mr. Lambert, it is mentioned that these trees grow there to a prodigious height, and are proportionably thick, being from 150 ft. to 200 ft. high, and from 12 ft. or 14 ft. to 28 ft. or 30 ft. in circumference. “These trees,” Captain Hunter continues, “from their immense height, have a very noble appearance, being, in general, very straight, and free from branches to 40 ft., and sometimes 60 ft., above the ground.” When some of these trees were felled, Captain Hunter observed that “most of them discharged a considerable quantity of clear water, which continued to flow at every fresh cut of the axe.” He adds, that there was no turpentine in them, but what circulated “between the bark and the body of the tree, and which is soluble in water;” also, that the timber is very short-grained and spongy. He states that the wood is so heavy, that 5 trees out of 6, when cut down, sank in water; but that, out of 37 trees cut down for repairing a ship, 27 were found defective. In green-houses near London, the rate of growth is 1 ft. or more a year; and a tree in the palm-house of Messrs. Loddiges attained the height of 40 ft., when it was stopped



2300

in its progress by the glass roof, but, in general, this is the case when they are less than half that height.

Geography, History, &c. The *Araucaria excelsa* is a native of New Caledonia, in Queen Charlotte's Foreland, and on a small neighbouring island, which is a mere sand-bank, only $\frac{1}{4}$ of a mile in circuit; also on the Isle of Pines, where it was found by Captain Cook. It was subsequently found by Dr. Brown, when on board the *Investigator*, with Captain Flinders, growing in great abundance on several parts of the east coast of New Holland; but it was not above 60 ft. or 70 ft. in height. It was introduced, according to Lambert, by Governor Philip; but, according to the *Hortus Kewensis*, by Sir Joseph Banks, in 1793. The plant is not uncommon in green-house collections, in most of which, in a few years, it grows as high as the roof will admit. One at Kew, which was at one time the largest in the country, was tried in the open air, and died the first winter. One in the conservatory in the Hammer-smith Nursery, which was planted in April, 1804, in seven years rose as high as the glass, and was obliged to be cut down; and this has been the case repeatedly since. It has now wide-spreading, pendulous, deep green



2299



2301

2302



branches, and a trunk upwards of 6 in. in diameter. One at Dropmore, in the open ground, was 14 ft. high in 1837; being protected during winter, so as to exclude the frost. One in M. Boursault's garden in Paris, which was kept in a conservatory during winter, and turned out during summer, was, in 1828, 12 ft. high; and, of this tree, the vignette *fig.* 2302. contains a portrait; it has since been removed to the conservatory at the Jardin des Plantes.

The timber of the *Araucaria imbricata* was found by Governor King to be sound only in the lower part of the trunk; but, in the upper part, too knotty, hard, and brittle to be useful; for which reason, no dependence could be placed on it for masts and yards. It is, however, he says, very suitable for buildings; and, when employed in erecting houses, it stands the weather very well. "The turpentine, which exudes freely from the bark, is of a milk-white glutinous substance; but it is rather remarkable that there is none in the timber. It was tried in paying boats, and for other purposes, but without success, as it would neither melt nor burn; it was also tried to make pitch or tar, by burning the old trees; but, there being no turpentine in the wood, all efforts of this kind were found useless." The fronds may be propagated by cuttings; and, when these have attained 5 or 6 years' growth, our opinion is, that, if the branches were pegged down, an erect shoot would arise from the collar; but this has scarcely been proved, except in the case of a plant observed by us in 1801, at Mongewell, near Wallingford, in Berkshire. A necessary precaution with this, and with every other species of the more valuable of the *Abietinæ*, is, during a storm of snow, occasionally to shake from the branches what adheres to them in masses. This should be done not only with young trees, but with trees in every stage of their growth; for the largest cedars, even in the climate of London, occasionally have their branches broken, in consequence of being heavily loaded with snow near their extremities.

"It is a highly interesting fact," says Dr Lindley, "that a plant very nearly the same as this *araucaria* certainly once grew in Great Britain. Remains of it have been found in the lias of Dorsetshire, and have been figured in the *Fossil Flora*, under the name of *Araucaria primæva*." (*Penn. Cyc.*, ii. p. 249.)

‡ 4. A. CUNNINGHAMII Ait. Cunningham's *Araucaria*, or the Moreton Bay Pine.

Identification. Ait. MS.; Swt. Hort. Brit., p. 475.; Lamb. Pin., 3.

Synonyme. *Altingia Cunninghamii* G. Don in Loud. Hort. Brit., p. 408.

Engravings. Lamb. Pin., 3. t. 96.; our *fig.* 2304. to our usual scale; and *fig.* 2303. of the natural size.

Spec. Char., &c. Decandrous. Leaves of the young tree vertically compressed, spinuloso-mucronate, straight; those of the full-grown tree lanceolate, acute, imbricated. Cones ovate; scales acuminate at the apex,

recurved, with membranaceous wings on the margin, replicate. (*Lamb. Pin.*, iii.) A tall tree, a native of New Holland. Introduced in 1824, and requiring the protection of the greenhouse.

Description. A tall tree, but more loose than *A. excelsa*; varying from 60 ft. to 100 ft. in height, with a very straight naked trunk, covered with a brownish bark, from 4 ft. to 8 ft. in diameter. Branches verticillate, spreading. Leaves smooth, shining green, of different forms: in the young tree, vertically compressed, divaricate and spreading, 2-rowed in a quincunx manner, linear-awl-shaped, spinulose and mucronate, straight, rigid, decurrent at the base, $\frac{1}{2}$ in. long; in the full-grown tree horizontal, and in a close spiral, incurved, loosely imbricated, lanceolate from the broad base, acute, glabrous, thick and coriaceous; flattish above keeled beneath, $\frac{1}{2}$ in. long. Male catkins terminating the branchlets, solitary, sessile, cylindrical, obtuse, 3 in. long, about as thick as the finger, a little contracted at the apex and base; scales peltate, stalked, closely imbricated, discoid and flattish, semi-ovate, mucronulate, callous; stalk linear compressed, bluntly keeled before, scarcely longer than the disk. Anthers many (10), linear, parallel, inserted under the disk of the scales, in 2 rows, and there connate, but in other respects free, pendent. Pollen rather large, spherical, smooth. Young cones only seen, terminal, solitary, sessile, ovate, 3 in. long, and of nearly the same thickness; about the size of the head of *Dipsacus fullonum*: scales wedge-shaped, thick, coriaceous, dark yellow, $\frac{1}{2}$ in. long, membranaceous and winged on the margin, replicate and wavy; point linear awl-shaped, spinulose and mucronate, recurved, callous, $\frac{1}{2}$ the length of the scale. Ovule conferruminate with the scale (flattened pericarpium), not free, but, as it were, concealed in the scale. Mature seed not seen. (*Lamb.*)

Geography, &c. The Moreton Bay pine is found, as the name imports, on the shores of Moreton Bay: it has also (according to a statement published by Mr. Allan Cunningham, the colonial botanist, in the 3d volume of *Lambert's Pinus*), a range

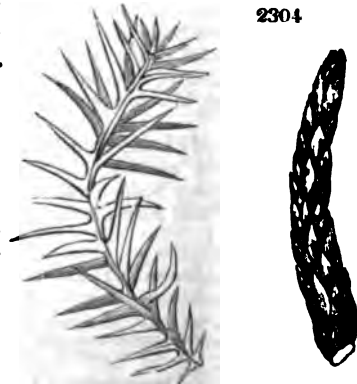
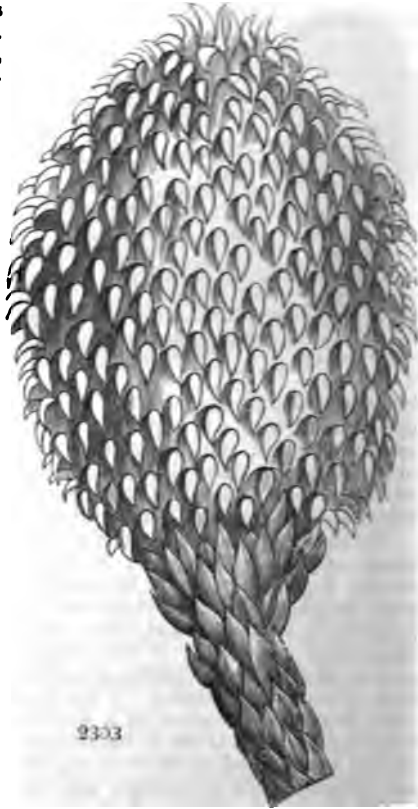

of 900 miles between the parallels of 14° and $29\frac{1}{2}^{\circ}$, on the eastern coast of New South Wales. On the alluvial banks of the Brisbane River, $27^{\circ} 30'$, it rises to the height of from 100 ft. to 130 ft., with a girth of from 14 ft. to 16 ft., and a clear trunk of 80 ft. It is found at a short distance from the river, in lat. 28° , and to the extent of 80 miles inland; but the trees are there comparatively small; and farther inland they entirely disappear. "Its maximum, therefore," says Mr. Cunningham, "is evidently on the coast, immediately within the influence of the sea air." This tree was first seen by Sir Joseph Banks and Dr. Solander, in 1770; but when the *Araucaria excelsa* was discovered on Norfolk Island in 1774, it was supposed to be the same species; the two trees, in their full-grown state, being very much alike. The Norfolk Island and Moreton Bay pines were consequently considered the same till the year 1824; when Mr. Allan Cunningham, visiting Moreton Bay in company with the late Mr. Oxley, satisfied himself "that it was a very distinct species, not simply in its habit of growth, which is very remarkable, but in the character of its leaves." Mr. Cunningham adds that "this pine bears young cones in the month of September. Its wood is of a pale yellowish deal, and is commonly used in house carpentry for making common furniture; and in boat-building at Brisbane Town. In the green state, its spars have been formed into masts for vessels of 200 tons, which are said to stand so long as the sap continues in them; but, after becoming dry, they are not to be depended on." It was sent from Sydney to Kew Gardens in 1824, and several plants have subsequently been imported. There are handsome specimens at Kew, Messrs. Loddiges's, Dropmore, and other places. That at Dropmore, presented to Lord Grenville by George IV., and of which *fig. 2305*, is a portrait, was, in 1837, 10 ft. high, after having been 7 years planted. It is carefully protected during winter, like the other tender species of this genus.



2305

GENUS VII.

CUNNINGHAMIA R. Br. THE CUNNINGHAMIA. *Lin. Syst. Monœcia*
Monadelphica.

Synonymes. *Pinus* Lamb., *Bèlis Salisb.*

Derivation. Named by Mr. Brown in honour of Mr. James Cunningham, "an excellent observer in his time, by whom this plant was discovered; and in honour of Mr. Allan Cunningham, the very deserving botanist who accompanied Mr. Oxley in his first expedition into the interior of New South Wales, and Captain King, in all his voyages of survey of the coast of New Holland. (*Bot. Mag.*, t. 2743).

Description. Only one species has been discovered, which is an evergreen moderate-sized tree, a native of China. Introduced in 1804.

2 1. *C. SINE'NSIS* Rich. The Chinese Cunninghamia, or Broad-leaved Chinese Fir.

Identification. Rich. Conif., p. 149. t. 18; Lamb. Pin., ed. 2., 2. t. 53.

Synonymes. *Bèlis jaculifolia Salisb.* in *Lin. Trans.*, 8. p. 316; *Pinus lanceolata* Lamb. *Monog.*, ed. 1., t. 34; *Araucaria major sinensis*, &c., *Pluk. Alm.*, 1. t. 351. f. 1; *Cunninghamia lanceolata* R. Br.; *Araucaria lanceolata* Hort.

Engravings. Rich. Conif., t. 18.; Lamb. *Monog.*, ed. 1., t. 34.; Pluk. *Alm.*, t. 351., f. 1.; Lamb. *Pin.*, ed. 2., t. 53.; *Bot. Mag.*, t. 2743.; our *fig. 2307.* to our usual scale; and *fig. 2306.* of the natural size.

Description, &c. A middle-sized tree, having the general appearance of *Araucaria*. Branches for the most part verticillate, spreading horizontally. Leaves sessile, deflexed, and spreading in every direction, $1\frac{1}{4}$ in. long; lanceo-

late, much pointed, rigid, flat, quite entire, somewhat scabrous on the margin. Male catkins terminal, fascicled, cylindrical, scarcely 1 in. long. Cones about the size of a walnut, sessile, drooping, globose, smooth. Scales ovate-acuminate, coriaceous, sharply denticulated on the margin. (*Lamb.*) This remarkable tree is a native of China, and was introduced in 1804, by Mr. Wm. Kerr, by direction of the Honourable Court of Directors of the East India Company. It was first supposed to belong to the genus *Pinus*, and was called *Pinus lanceolata*, from its sharp lanceolate leaves; but, on more careful examination, it was made a separate genus by Mr. Salisbury, in the *Linnaean Transactions*, under the name of *Bélis*, from *belos*, a javelin; from the leaves somewhat resembling in form the head of that weapon. The name of *Béllis* having been already applied to the daisy, that of *Bélis* was considered to bear too strong a resemblance to it, and accordingly it was afterwards changed by Mr. Brown to *Cunninghámia*; by which name it was first described by M. Richard, in his *Mémoires sur les Conifères*. For many years after it was first introduced, it was kept in the green-house; but, in 1816, a plant was turned out into a sheltered part of the pleasure-ground at Claremont, where it has continued to live without protection; and, though injured more or less by severe winters, it was, in 1837, 18 ft. high, the diameter of the trunk 7 in., and of the head 16 ft. A tree at White Knights, which had stood without the slightest protection for upwards of 10 years, was, in 1837, upwards of 25 ft. high, and formed a most beautiful object. A tree at Dropmore, planted in the open ground in 1822, was, in 1837, 17 ft. high. It was matted up every winter for several years after it was planted out; but, since 1828, it has received no protection whatever, and is now a very fine tree. This species is very readily propagated

by cuttings; and there are some trees at Dropmore, raised in this manner, which have thrown up erect stems from the collar, which will doubtless form as handsome trees as seedlings. The practice of pegging down the branches of plants of *Coniferae* raised from cuttings, with a view to the production of erect stems, appears to have been first exemplified in this species, and by Mr. Stewart Murray, the curator of the Glasgow Botanic Garden, who has given the following account of it in the *Gardener's Magazine*: — "In the Glasgow Botanic Garden, in 1825, were two plants, 2 ft. or 3 ft. high, struck from cuttings several years previously, the tops of which, though the trees were in very luxuriant health, still retained the appearance of a branch, which, even when tied up to a stake, always seemed as if endeavouring to regain its horizontal position. During the winter of 1825," continues Mr. Murray, "I loosened the top of one from its stake, and fastened it down quite in a horizontal direction; in about six weeks afterwards, a very vigorous shoot made its appearance from below the surface of the earth in the pot. When this shoot had attained the height of 8 in. or 9 in., I cut away the old top entirely, and at

2306



2307



this time (February, 1827) the centre shoot produced is nearly 2 ft. high, and is furnished all round with three sets, or tiers, of regular horizontal branches. I may add that this plant flowered with us in January, 1827, and was figured in the *Botanical Magazine*, t. 2743. In 1826, I repeated my experiment on the other plant with the very same success." (*Gard. Mag.*, ii. p. 410.)

Statistics. In the environs of London the largest plant is in the Hammersmith Nursery, which is upwards of 10 ft. high, and would have been twice that height had it not been cut down, upwards of 10 years ago, on account of its being too high for the house in which it then stood. At Fulham Palace, it is 5 ft. high; and there are plants of about this height in the Horticultural Society's Garden, Messrs. Loddiges's arboretum, Chestnut, Bayfordbury, and various other places. Those at Claremont, and White Knights, have been already mentioned. At Redleaf, it is 8 ft. 2 in. high. At Edinburgh, in the Botanic Garden, it is 4 ft. 6 in. high; and in the Experimental Garden, 2 ft. 6 in. high. In Ireland, there are plants in the different botanic gardens; and at Ortel Temple there is one, which, in 1834, after being 12 years planted, was 7 ft. high. In Austria, at Vienna, at Laxenburg, where it receives protection during winter, 5 years planted, it is 6 ft. high. In Italy, at Monza, 10 years planted, it is 30 ft. high. Price of plants, in the London nurseries, one guinea each.

GENUS VIII.

DA'MMARA Rumph. THE DAMMAR, or AMBOYNA, PINE. *Lin. Syst.* Monœcia Monadélphia.

Synonymes. Pinus Lamb., A'gathis Sal.

Derivation. From dammar, the name, in Amboyna, of the resin which it produces.

Description. Large, broad-leaved, evergreen, timber trees, abounding in resin; natives of Amboyna and New Zealand; and requiring, in England, the protection of a greenhouse.

‡ 1. D. ORIENTALIS Lamb. The Oriental Dammar Pine, or Amboyna Pitch Tree.

Identification Lamb. Pin., t. 54.

Synonymes. Pinus Dammara Willd. Sp. Pl., 4. p. 503.; Lamb. Monog., ed. 1., p. 32., Ait. Hort. Kew., ed. 2., 5. p. 321.; Dammara filia Rumph. Amboyn., 2. t. 57.; A'gathis toranthifolia Sal. in *Lin. Trans.*, 8. p. 312.; Lindl. in *Penn. Cyc.*; A. Dammara Rich. Conif., p. 83.; A'ribor javanensis, &c., *Rail Hist.*, 3., *Dendr.* p. 130.

Engravings Lamb. Pin., t. 54.; *Lin. Trans.*, 8. t. 15.; Rich. Conif., t. 81.; Lamb. Monog., ed. 1., t. 38., and our fig. 2309. to our usual scale, and fig. 2308. to the natural size.

Spec. Char., &c. Leaves opposite, oval-oblong, parallel-veined, attenuated at the base. Cones turbinate; scales adpressed, round at the apex. (*Lamb. Pin.*) A large tree, a native of Amboyna. Introduced in 1804.

Description, &c. Rumphius describes it as a very tall tree, with a straight, upright, cylindrical

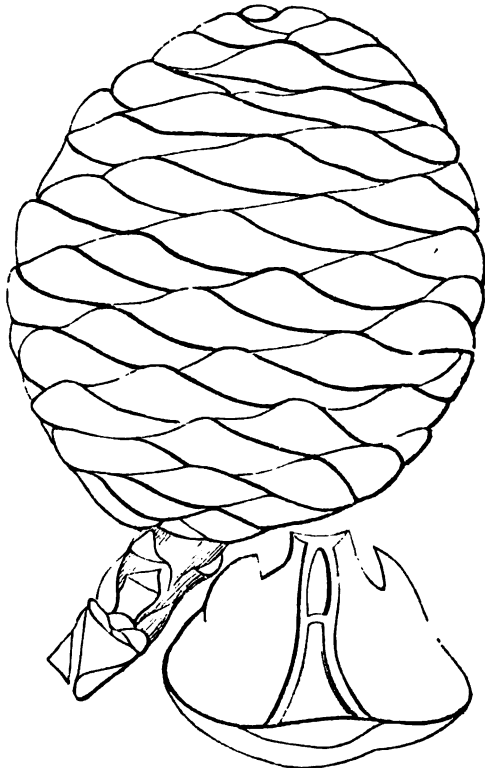

2308

trunk, smooth bark, and rather small head. Branchlets leafy and tetragonal. Leaves alternate or opposite, lanceolate, oblong, quite entire, glabrous, of a coriaceous texture, and a glaucous green; about 2 in. long, and nearly 1 in. broad, slightly striated longitudinally. The flowers are unisexual; the male catkins are ovate-oblong-shaped, about the size of a pigeon's egg, on a short peduncle, thick, and placed a little above the axes of the leaves. The male catkins are composed of a great number of obtuse imbricated scales: each scale is wedge-shaped, and abruptly curved inwardly at its upper extremity; the lower extremity is occupied by from 8 to 15 anthers, disposed in two rows. The female catkins are of the same form as the males; and they also are formed of obtuse, imbricated, thick, coriaceous scales. The dammar is distinguished from the pines and firs by its female flowers being solitary and not twin; and by the form and structure of its male flowers. It approaches nearest to the genus *Araucaria*, from which it differs in the form of its scales, in the absence of a bractea to each female flower, and by its seed being winged only on one side. (*A. Rick* in *Dict. Class. d'Hist. Nat.*, t. 5. p. 321.) The tree is found on the very summit of the mountains of Amboyna and Ternate, and in many of the Molucca Islands. The wood is said to resemble that of the cedar, and to be light and of inferior quality, wholly unfit for any situation exposed to the action of the weather, but answering tolerably well for indoor purposes. The most interesting produce of the tree, however, is its resin. (See *Dr. Linn.* in *Fens. Cyc.*) The resin, when it first flows from the tree, is soft and viscous; but in a few days it becomes as hard as stone, and has all the transparency and whiteness of crystal, especially that which adheres to the trees, and sometimes hangs from them in the shape of icicles. These crystals are sometimes 3 in. or 4 in. broad, and 1 ft. long, and exhibit an elegant striated appearance. They are very brittle, and, when broken, shine like glass. The resin does not retain its whiteness more than five or six months; after which it assumes a beautiful amber colour. Though the resin generally exudes naturally in great abundance, it is sometimes obtained artificially by making incisions in the bark. The smell of fresh and soft dammar is resinous; but, when dry, it does not emit any particular odour. When thrown upon burning coals, it smells like turpentine and mastich. It is very inflammable, and burns without crackling, though it emits a great quantity of acidulous smoke, which produces a very unpleasant effect on those who are unaccustomed to it. (See *Lambert's Pinus*, ff. p. 99.) *Dr. Lindley* says: "Liquid storax is thought to be yielded by the dammar pine; and a substance called in India dammar, or country resin, is procured from the same plant, or from a tree which *Dr. Buchanan* calls *Chloroxylon Dusada*." (*Annals*, l. p. 337., as quoted in *Nat. Syst. Bot.*, ed. 2, 1836.) This species was introduced into England in 1804, by Sir Joseph Banks; but, not being readily propagated, it is extremely rare. The only plant that we recollect to have seen is that at Kew, where it is kept in the greenhouse; though, as it is found on high mountains, it may possibly be as hardy as Cunninghamia.



2. *D. AUSTRALIS* Lamb. The southern Dammar, or *Kauri*, Pine.

Identification. Lamb. Pin., ed. 2, 2. t. 55.

Synonymes. *A'gathis australis* Lindl. in *Pena. Cyc.*; Cowrie tree, New Zealand Fitch tree, Kowrie Pine.

Engravings. Lamb. Pin., ed. 2, 2. t. 55; our fig. 2310. to our usual scale; and fig. 2311. of the natural size.

Spec. Char., &c. Leaves alternate or opposite, linear-oblong or elliptic, veinless, rigid. Cones turbinate; scales spreading, acute at the apex. (*Lamb. Pin.*) A large tree, a native of New Zealand. Introduced in 1821, but requiring the protection of a greenhouse.

Description. A large tree, attaining the height of from 80 ft. to 140 ft. Trunk very straight, without branches to the height of 40 ft. or 70 ft., and from 4 ft. to 7 ft. in diameter; covered with an entire, very thick, lead-coloured bark. Branches numerous, spreading, somewhat remote, about the thickness of a man's body, divided into numerous small branches; ascending and leafy towards the top, naked at bottom from the falling of the leaves. Wood white, abounding in a liquid resin. Leaves numerous, opposite, often (in adult trees) alternate, sessile, linear-oblong, or rarely elliptic, very similar in texture and appearance to those of *Buxus*, obtuse, quite entire, emarginate, coriaceous, rigid, erect, and spreading; from $\frac{1}{2}$ in. to $1\frac{1}{2}$ in. long, and $\frac{1}{4}$ in. to $\frac{1}{2}$ in. broad; flat on both sides, shining, nerveless; pale green; broadish at the base, not narrowed, as in *D. orientalis*. Catkins solitary, axillary on the tops of the branches, on very short thick footstalks; male cylindrical, erect, 1 in. long, 2 lines in diameter, very compact, imbricated, hard, in some having rounded bractea at the base. Anthers 5-6 on one scale, pendulous, situated under a convex, somewhat orbiculate, thick, bony, entire crest, scarcely adhering together, disposed round the lower side of the columella, each filled with yellow pollen, 1-celled, opening longitudinally; female erect, oblong, 1 in. in length, on a very short, thick, woody, pedicel. Cones scattered, solitary on the tops of the branches, turbinate, erect, pedicellate: scales short, broad, wedge-shaped, thick, coriaceous, closely imbricated, ferruginous on the inside; dilated, waved, and membranaceous on the margin; thicker externally towards the apex, woody, cartilaginous, smooth, hard, of a dull leaden ash-colour, spreading and acute at the apex: seeds in twos, wedge-shaped, brown, having at the apex on one side a membranaceous, quite entire, oblique, pale-coloured wing. (*Lamb.*)

Geography, History, &c. The *Kauri* pine is a native of New Zealand, on the banks of the river there which Captain Cook named the Thames. It was discovered in the year 1769, on Captain Cook's first voyage, and an enormous tree of it was then cut down. The straightness of the trunk,



and fine grain of the wood, made Captain Cook think that, if it proved light enough, it would make excellent masts. In consequence of his report, but several years afterwards, a small spar was brought to England by the Catharine whale-ship, which proved, to use the seamen's phrase, "a stick of first-rate quality." Captain Cruise was afterwards sent out in the Dromedary to bring home some spars of this wood. He found many trees with trunks 100 ft. high, without a single branch, and then forming large heads; while the trunks of others, not so tall, were 40 ft. in circumference. It was, however, very difficult to procure spars, as the large trees grew on the very summit of the highest hills. Two ships were afterwards sent out under Captain Downie, who not only brought home timber, but a living plant, which was presented to the Horticultural Society about 1821. (See *Lamb. Pin.*, ed. 2., 2. p. 103.) In 1833, another expedition was sent out for kauri pine in His Majesty's ship Buffalo; and it was accompanied from Sydney by the late Mr. Richard Cunningham, who found "many fair and noble specimens of the undisputed monarch of the forest, the kauri pines with their vast heads towering above the other gigantic timbers of those deeply shaded regions, supporting on their upper branches large tufts of those tilandsia-like epiphytes, the species of *Atella*, originally discovered by Sir Joseph Banks. These plants are much valued by the natives for the sweetness of the stem on which the flowers grow. They (the natives) will climb, says Mr. Gates, the highest tree, in search of these epiphytes; and, when they have gathered them, they will sit for a long time at the bottom of the tree, sucking out the juice of the stem; which to them, especially on a hot day, is peculiarly grateful. These plants give the smaller groves the appearance of an English rookery, and there only wants the tui (*Meros cinclinnatus Latk.*), that polyglot bird of the woods of New Zealand, to imitate the cawing of the rook, to make the deception complete."

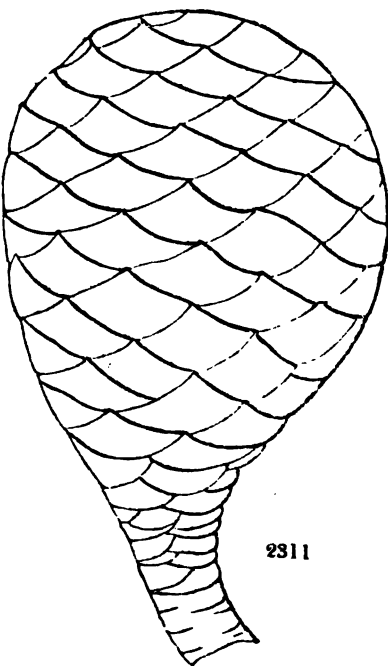

(*Comp. to Bot. Mag.*, ii. p. 217.) The excellence of the wood of this tree has been already mentioned, and Mr. Lambert adds to his account of it, that, on an experiment being tried as to the comparative strength of the wood, and that of the Riga pine, the result was as follows:— Both pines were 1½ in. square, 3 ft. long, and suspended 10 in. from the end. The kauri pine bore a weight of 1 cwt. 2 qr. and 15 lb. before it broke, and the Riga pine weighed only 1 lb. 8 oz. (*Lamb. Pin.*) In 1837, a contract was made to send a large quantity of wood of this pine to England. The tree yields, both spontaneously and by incision, a great quantity of pure limpid resin, which hardens by exposure to the air, and which is excellent as varnish. In 1837, Mr. Lambert received an immense mass of this resin, 6 in. or 8 in. in diameter. The outside is opaque, and of a dirty white; but, when broken, it has a glassy transparent look, and a pale green tinge. The *Dissmura australis* was first treated as a hot-house plant in England, but has since been found to thrive better in the green-house. There is a tree planted out at Dropmore, which, in 1837, was 5 ft. high. It was, however, very unhealthy, and requires to be strongly protected in winter.

App. i. *A Tabular View of the principal Pinetums, or Collections of Abietinæ, in Europe.*

The names of the pinetums are arranged, as nearly as could be ascertained, in the order in which they were commenced; and the species in the order in which they are described in the preceding pages. The existence of a species in any pinetum is indicated by its height in feet, according to measurements sent us in 1837; but, when the height is not exactly known, the existence of a species or variety in any pinetum or collection is indicated by a cross, thus +. When the species or variety is of doubtful existence in any collection, a point of interrogation is used; and when it is wanting, a cipher is introduced.

It is proper to observe, that our table, which occupies the two following pages, does not contain nearly so many names purporting to be species and varieties, as are in some of the original lists of the collections sent to us. For example, in the catalogue of the pinetum at Flitwick, (which ranks next to that at Dropmore, in the number of kinds,) there are of *Pinus* 59 names of species and varieties, of *Abies* (including *Picea*) 27, and of *Larix* 7. The reason why we have omitted several of these names is, that we are doubtful as to the application of some of them, and consider others as only varieties, or as

synonymes; while some of the names, which we acknowledge to be those of existing varieties, are omitted, because we think the varieties themselves of very little consequence, and scarcely worth notice.

Besides the pinetums and collections shown in the above tabular view, there are others which would have been included in it, had there been room; and a number of collections, more or less complete, which deserve to be recorded, as illustrative of the present taste for the culture of the pine and fir tribe. All of these that we have been able to recollect at the moment are included in the following paragraphs:—

In England, besides the pinetums noticed in the tabular view, there are collections at Syon and Whitton Park, Middlesex; Pain's Hill, Claremont, and Ockham Park, Surrey; Redleaf and Deepdene, Kent; Bayfordbury, Hertfordshire; White Knights and Bear Wood, Berkshire; Wardour Castle, Bowood, and Boyton House, Wiltshire; Bicton, Devonshire; Croome, Warwickshire; Trentham, Staffordshire; Carlton Hall, Durham; Clumber Park, Nottinghamshire.

The English Nurseries which possess the best collections are those of Messrs. Loddiges, Hackney; Messrs. Whitley and Osborn, Fulham; Messrs. Lee, Hammersmith; Messrs. Brown, Slough; Mr. Donald, Goldworth; and Messrs. Dickson, Chester. The best assortment of pine and fir seeds for sale is kept by Mr. Charlwood, London.

In Scotland, the best collections not included in the tabular view are: at New Posso, Peeblesshire; Oxenford Castle, and Hopetoun House, near Edinburgh; and Methven Castle, Perthshire.

The Scotch Nurseries which contain the best collections are those of Messrs. Cunningham and Messrs. Lawson, Edinburgh; Messrs. Turnbull and Dickson, Perth; and Mr. Roy, Aberdeen. The best collection of pine and fir seeds is kept by Mr. Lawson of Edinburgh.

In France, there are the following collections:—

1. *True Pinetums (Collections botaniques)*. Madame Aglié Adanson, at Balenie, near Moulins, Allier; Dumont de Courset, at Courset, near Sauer, Pas de Calais; M. Ivoy, at Bordeaux.

2. *Botanical Forests (Botanique forestière)*. M. Vilmorin, at Barres, near Nogent sur Vernisson, Loiret.

3. *Amateur Collections less complete than the Pinetums*. Count de Montbron, at Chatellerault; Baron de Tschoudi, at Metz; Viscount Héricart de Thury, in the environs of Paris; M. Bobée, near Châteauneuf, Haute Loire; M. De Lorgeril, at Baumanoir, near Rennes; Marquis de la Boessière, at Malleville, near Ploermel; Baron de Morogues, at La Source, near Orleans; M. Mallet De Chilly, at Sologne, near Orleans; M. De la Giraudière, Sologne, near Blois; M. Macarel, near Gien; M. Doublat, at Epinal; Viscount de Courval, and Count de Burnonville, in the environs of Paris; Count de Tristan, at Orleans. The late M. De Courson, near St. Briene; the late Du Hamel du Monceau, at Denainvilliers, at Monceau, and at Vrigny, near Pithiviers; and of M. De Malesherbes, at Malesherbes.

4. *Experimental Plantations (Plantations (non plus Collections) forestières expérimentales)*. M. Delamarre, at Harcourt; M. Marcellin Vétillard, at Mans; M. Bérard, sen., at Mans; M. Bataille de Mandelat, at Autun; M. Doulcet, La Fay, near Aubigny; and the government plantations in the forests of Fontainebleau, Compiègne, and Villers Cotterets, and in the Bois de Boulogne.

5. *Plantations of particular Species*.—*Pinus Laricio*, by M. Le Roy, at Boulogne-sur-Mer; and the Count Lemarrois. *P. sylvéstris*, by the Viscount Ruinard de Brimour at Rheims; and many others in Champagne. *Larix europæa*, by the Count de Rambuteau. *Picea pectinata*, by M. De Candecoste, at Laigle; besides many other plantations in Normandy.

The principal nurseries in France which contain collections of pines and firs are, those of M. Cels, M. Godefroy, and M. Soulange-Bodin, at or near Paris; and that of Messrs. Baumann at Bollwyller. The seedsman who keeps the most extensive collection of pine and fir seeds is M. Vilmorin, Paris.

In Belgium, the collection of the Baron de Serret, at Bruges.

In *Germany*, the principal collections, next to that in the Botanic Garden Berlin are : at Wörlitz, in Saxony ; at Harbcke, in Hanover ; at Brück on the Leytha, near Vienna ; in the University Botanic Garden, Vienna ; and in the Botanic Garden, Göttingen. The nursery in Germany in which there is the most complete collection of Coniferæ is that of Messrs. Booth, Hamburg, who also keep the best assortment of pine and fir seeds.

In *Russia*, there are collections in the Imperial Botanic Garden, St. Petersburg ; and in the Government Garden at Nikitka, in the Crimea.

In *Denmark*, there is a collection in the Royal Gardens, Rosenburg, Copenhagen.

In *Sweden*, in the Botanic Garden at Lund.

In *Italy*, in the Botanic Garden at Monza, near Milan.

Sect. II. CUPRESSINÆ.



THE Cupressinæ differ from the Abietinæ in being for the greater part shrubs or low trees, instead of lofty trees. They are all evergreen, with the exception of one species of *Taxodium* (*T. distichum*, the deciduous cypress) ; and none of them have the branches disposed in whorls, as is the case with all the pines and firs without exception. The greater part of the species are natives of warm climates, and comparatively few of them are perfectly hardy in British gardens. One only, the common juniper, is a native of Britain ; but between 30 and 40 foreign species and varieties endure the open air in England ; and 8 or 10 of these (exclusive of *Taxodium*), which have been not less than 30 or 40 years in the country, and which have had time to display their shapes, form very handsome or remarkable evergreen low trees, or tall shrubs ; such as the red cedar, the white cedar, the eastern and western arbor vitæ, the Phœnician and tall juniper, the cedar of Goa, the common and spreading cypress, &c. The greater number of the species or alleged species have, however, been but a short time in British nurseries, and are only to be seen as very young plants in the nurseries, or in very choice collections. These lately introduced kinds are so imperfectly known among cultivators, that little dependence is to be placed on the names which are applied to them ; and therefore all that we can recommend is, that they should be as extensively introduced into collections as possible, in order that they may grow up to some size, and be examined in various situations by different botanists. In collecting, with a view to this object, some of the alleged kinds will doubtless turn out duplicates, but the only objection to this, in the case of such very rare and interesting evergreens, is the first cost, which is comparatively a trifle. It may be observed of all the species of Cupressinæ, that it is not easy to describe by words, and scarcely practicable to illustrate by figures, without the fruit, many of the different species of this family ; nevertheless, to a practised eye, it is easy to distinguish the three leading genera, viz. *Thuja*, *Cupressus*, and *Juniperus*, by a portion of the branch, without either flowers or fruit. The flattened, two-edged, scaly, imbricated shoots of all the *thujas*, including *Callitris* (which may, if the reader chooses, be considered a subgenus), are two-edged, whether the specimen be young or old ; those of *Cupressus* are scaly and imbricated, but angular or roundish, and never two-edged ; and those of *Juniperus*, in the young state of the plants, have distinct acerose leaves, generally glaucous above, and often in threes joined at the base.

Propagation and Culture. All the kinds may be propagated by layers and cuttings ; and the most common species ripen seeds in Britain in abundance. The seeds, which generally lie a year in the ground, may be sown in spring ; and the young plants may be treated in all respects like those of the pine

and fir tribe. When the seeds are sown in autumn, immediately after being gathered, they sometimes come up the following year. Cuttings should be made in autumn, of the wood of the same year, with a small portion of the preceding year's wood attached; and they should be planted in sand, or in a very sandy loam, in a shady border, and covered with hand-glasses. Cuttings put in in September will form callosities at their lower extremities the same autumn, and should be protected by mats during severe frosts in winter: the following autumn they will be ready to transplant. Layers may be made either in autumn or spring.

GENUS IX.

**THUJA L. THE ARBOR VITÆ.** *Lin. Syst. Monœcia Monadelphica.*

Identification. *Lin. Gen.*, 1078.; *Reich.*, No. 1176.; *Schreb.*, No. 1457.; *Tourn.*, t. 538.; *Juss.*, 413.; *Gærtn.*, t. 91.; *Lamb. Pin.*, ed. 2., 2.

Synonymes. *Thuja*, or *Arbre de Vie*, *Fr.*; *Lebensbaum*, *Ger.*

Derivation. From *thyon*, sacrifice; in consequence of the resin of the Eastern variety being used instead of incense in sacrifices. Why it was called *Arbor Vitæ* is uncertain. *Parkinson* says the American species was presented to Francis I. under this name, and that it has been continued ever since, though for what reason he knows not. It was called the *Arbor Vitæ* by *Clusius*. *Royle* mentions that, in the East, the cypress is called the tree of life; and that its berries, &c., are considered a cure for all diseases.

Description, &c. Narrow, pyramidal, evergreen trees, or large fastigate shrubs; natives of Asia, Africa, and North America, and for the most part hardy in British gardens. The species have been divided by Professor *Don* into the following sections:—

1. *Thuja vèræ.* Cones oblong-compressed; scales consisting of a definite number (4 or 6), coriaceous, smooth, with one tubercle under the apex; two exterior ones shortened, boat-shaped. Seeds compressed, winged. To this belong *T. occidentâlis L.*, *T. plicatâ Donn.*, and *T. chilênsis D. Don.* In *T. occidentâlis* the seeds are flattened, winged all round, emarginate at the apex.
2. *Bidâ.* Cones roundish, squarrose; scales indefinite in number, peltate, woody. Seeds belying, crustaceous, without wings. To this belongs *T. orientâlis L.*
3. *Cyparissâ.* Cones roundish; scales indefinite in number, peltate, woody. Seeds winged at the apex. To this belong, *T. cupressoides L.*, *T. pênsilis D. Don.*, and *T. pëndula D. Don.*

§ 1. *Thuja vèræ.*‡ 1. *T. OCCIDENTALIS L.* The western, or American, *Arbor Vitæ.*

Identification. *Hort. Cliff.*, 449.; *Hort. Ups.*, 289.; *Roy Lugd.*, 87.; *Smith in Rees's Cyc.* No. 1.; *Kalm Itin.*, 3. p. 389.; *Mill. Dict.*, No. 1.; *Du Roi Harbk.*, 2. p. 455.; *Blackw.*, t. 210.; *Kniph. Cent.*, 1. No. 91.; *Wang. Amer.*, 7. t. 2.; *Willd. Arb.*, 383.; *Baum.*, 504.; *Sp. Pl.*, 4. p. 508.; *Michx. Arb.*, 3. t. 29.; *N. Du Ham.*, 3. p. 12.; *Pursh Fl. Amer. Sept.*, 2. p. 646.; *Michx. N. Amer. Syl.*, 3. p. 226.; *Rich. sur les Conif.*, p. 43.

Synonymes. *Thûja Theophrásti Bauh. Pin.*, 488.; *Arbor Vitæ Cæs. Hist.*, 1. p. 36.; white Cedar, *Amer.*; Cèdre américain, Cèdre blanc, *Arbre de Vie*, *Fr.*; gemeiner Lebensbaum, *Ger.*; *Arbero do Vita*, *Ital.*

Engravings. *Blackw.*, t. 210.; *Wang. Amer.*, 7. t. 3.; *Michx. Arb.*, 3. t. 29.; *Rich. Con.*, t. 7. f. 1.; our *figs.* 2312. to 2314.; and the plate of this tree in our last Volume.

Spec. Char., &c. Branchlets 2-edged. Leaves imbricated in 4 rows, ovate-rhomboid, adpressed, naked, tuberculated. Cones obovate; interior scales truncate, gibbous beneath the apex. (*Willd.*) A moderate-sized tree, or large shrub; a native of Canada, and in cultivation in England since 1596; flowering in May, and ripening its cones in the following autumn.

Varieties.

- ‡ *T. o. 2 variegatâ Marsh.*, p. 243.; *T. o. fôliis variegâtis Lodd. Cat.*, 1836; has the leaves variegated. There is a tree in the Horticultural

2312

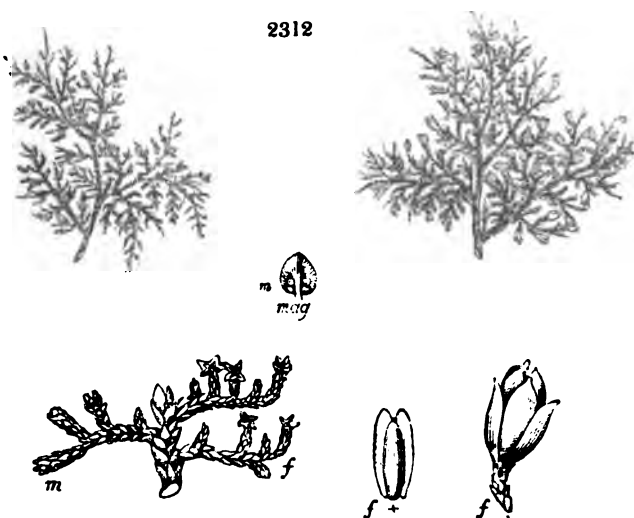

Society's Garden, 8 ft. high, which was received in 1831, from Mr. Hodgkins of the Dunganstown Nursery, in the County Wicklow.

† *T. o. odorata* Marsh., l. c., N. Du Ham., lli. p. 13., is said to be more fragrant than the species. We have not seen the plant.

Description, &c. The American arbor vitæ, in its native country, according to Michaux, is a tree from 45 ft. to 50 ft. in height, with a trunk sometimes more than 10 ft. in circumference; though, in general, it is not above 11 in. or 15 in. in diameter at 5 ft. from the ground. From the number of the concentric circles, 117 of which Michaux has counted in a log 13 in. 5 lines in diameter, its growth appears to be extremely slow. The foliage is numerously ramified, and flattened, or spread out laterally. The leaves are small, opposite, imbricated scales: when bruised, they diffuse a strong aromatic odour. The sexes are separate upon the same tree: the male catkins are in the form of small cones, which, when ripe, are yellowish, about 4 lines in length, and composed of oblong scales, which open throughout their whole length for the escape of several minute seeds, each of which is surmounted by a short wing. The flowers appear early in spring, and the catkins are matured towards the end of September. In America, the full-grown arbor vitæ is easily distinguished from all other trees by its shape and foliage. The trunk tapers rapidly from a very large base to a very slender summit; and it is furnished with branches for four fifths of its height. The principal limbs are widely distant from each other, placed at right angles with the trunk, and have a great number of drooping secondary branches. The bark upon the trunk is slightly furrowed, but smooth to the touch, and very white when the tree stands exposed. The wood is reddish, somewhat odorous, very light and soft, and fine-grained. (*Michx.*) Compared with the Chinese arbor vitæ, the American species is a loose irregular-headed tree, with the branches much more horizontal than in that species. The rate of growth, in the climate of London, is from 6 in. to 1 ft. in a year. In ten years, in favourable soils, it will attain the height of 10 ft. or 12 ft.; and in 30 or 40 years, in moist sheltered situations, drawn up by other trees, it will attain the height of 30 ft. or 40 ft. The largest specimens in the neighbour-



2313



hood of London are at Syon, where it is between 25 ft. and 30 ft. high. At Pain's Hill, in a moist bottom near the water-wheel, there is a tall erect tree, between 30 ft. and 40 ft. high; and, in Studley Park, the spreading tree of which *fig. 2314.* is a portrait to the scale of 1 in. to 12 ft., is 45 ft. high, with a head 40 ft. in diam. This remarkable tree has no main trunk, but divides into several large limbs near the ground. Another tree, in the same park, of which *fig. 2313.* is a portrait to the scale of 1 in. to 24 ft., is, on the contrary, 50 ft. high, with the side branches small like those of a larch.

Geography and History. The *Thûja occidentâlis* is found in North America, from Canada to the mountains of Virginia and Carolina. According to Pursh, it is rather scarce in the southern states, and is only found there on the steep banks of mountain torrents. Michaux states that it is found on the Hudson in abundance, and near the Rapids of the Potomac, in Virginia. Goat's Island, round which the Niagara divides itself to form the stupendous cataract so universally admired, is bordered with trees of *Thûja occidentâlis*. Mr. M'Nab, in 1834 (see p. 182.), found it in abundance in these habitats, and in various other places between New York and Canada. In Canada, and in the northern parts of the United States, it is called the white cedar; but in the district of Maine it is more commonly known as the arbor vitæ. In Lower Canada, New Brunswick, Vermont, and the district of Maine, the arbor vitæ is the most abundant of the resinous trees, after the black and the hemlock spruces. A cool soil seems to be indispensable to its growth. It is never seen on the uplands among the beeches, the hiches, &c., but is found on the rocky edges of the innumerable rivulets and small lakes which are

scattered over these countries; and it occupies in great part, or exclusively, swamps from 50 acres to 100 acres in extent; some of which are accessible only in the winter, when they are frozen over and covered with several feet of snow. It abounds exactly in proportion to the degree of humidity which exists in the soil; and in the driest marshes it is mingled with black spruce, the hemlock spruce, the yellow birch, the black ash, and a few specimens of the white pine. In all of these marshes, the surface is covered with a bed of *Sphagnum*, so thick, and so surcharged with moisture, that the foot sinks half-leg deep into it, while the water rises under the pressure. On the borders of the lakes, where the arbor vitæ has room, and enjoys the benefit of the light and air, it rises perpendicularly, grows more rapidly, and attains a greater size, than when crowded in the swamps, where its thick foliage intercepts the light from the trunk, and impedes the circulation of the air. In the swamps, its trunk is rarely straight, but forms an elliptic curve, more or less inclined to the ground. (*Michx.*) "By a strange mistake of Linnæus, this species is handed down as a native of Siberia; because Gmelin (*Fl. Sib.*, v. i. 182) mentions a *Thuja*, to which he misapplies the synonymes of the present, but which, by his own account, is different; for he says it is paler than the garden kind, and smaller in all its parts. It was brought to him by a travelling surgeon, from rocks near Pekin in China, and could be no other than *T. orientalis*." (*Smith in Rees's Cyc.*) The American arbor vitæ appears to have been first introduced into Europe in the time of Francis I., at the beginning of the sixteenth century; Clusius having stated that the first tree that he saw of it was one in the Royal Garden at Fontainebleau, which had been sent from Canada as a present to that monarch. It was cultivated in England by Gerard, who observes, writing in 1596, that, though not a native of the country, it grew in his garden very plentifully. As the tree ripens abundance of seeds, it is readily propagated, and, from the time of Gerard, has been one of our commonest hardy evergreens.

Properties and Uses, &c. From the shape of the main stem, Michaux observes, it is difficult to procure trunks of a considerable length, and a uniform diameter; hence, in the district of Maine, the timber of this tree is little employed for the framework of houses, though in other respects it is proper for this purpose. It is softer than the white pine, and gives a weaker hold to nails; for which reason, the Canadians always join it with more solid wood. The elder Michaux, in his journey to Hudson's Bay in 1792, found the church established there by the Jesuits yet standing. This building, constructed in 1728, as was proved by an inscription over the door, was built with square logs of the arbor vitæ, laid one upon another, without covering on either side; and it had remained perfectly sound more than 60 years. The most common use of this tree is for rural fences, for which it is highly esteemed. The posts last 35 or 40 years, and the rails 60 years; or three or four times as long as those of any other species. The posts remain undecayed twice as long in argillaceous as in sandy soils. In Canada, the wood of the arbor vitæ is selected for the light frames of bark canoes. Its branches, garnished with leaves, are formed into brooms, which exhale an agreeable aromatic odour. Kalm affirms that the leaves, pounded and mixed with hog's lard, make an excellent ointment for the rheumatism. (*Michx.*)

In Britain, the American arbor vitæ can only be considered as an ornamental shrub or low tree; thriving well in any soil, even in the most exposed situations, but attaining its largest size in low, sheltered, and moist places. It bears the knife and the shears; and is frequently employed to form hedges for shelter in gardens and nursery grounds. The smaller branches are long, slender, and remarkably tough, and may be used as ties to faggot-wood, or wattles to fences, where strength and durability are required. The tree is readily propagated by seeds, which are procured in abundance from America, or gathered from British trees; or by cuttings.

Statistics. In the environs of London. At Mount Grove, Hampstead, it is 20 ft. high, with a trunk 10 in. in diameter; in the Fulham Nursery, 20 years planted, it is 30 ft. high; at Stanmore, at Abercorn Priory, it is 33 ft. high; at Gunnersbury Park are several cone-shaped trees, 30 ft. high. — South of London. In Hampshire, at Alresford, 13 years planted, it is 19 ft. high. In Surrey, at

Bagshot Park, 12 years planted, it is 20 ft. high. In Berkshire, at White Knights, 34 years planted, it is 25 ft. high. In Buckinghamshire, at Temple House, 40 years planted, it is 16 ft. high. In Essex, at Braybroke, 51 years planted, it is 35 ft. high. In Nottinghamshire, at Clumber Park, it is 30 ft. high, the diameter of the trunk 1½ ft., and of the head 22 ft. In Radnorshire, at Maelaugh Castle, it is 30 ft. high, the diameter of the trunk 1½ ft., and of the head 15 ft. In Shropshire, at Kinlet, 60 years planted, it is 30 ft. high. In Staffordshire, at Teddesley Park, 14 years planted, it is 16 ft. high; at Rolleston Hall, 50 years planted, it is 25 ft. high, the diameter of the trunk 1 ft., and of the head 10 ft. In Suffolk, at Finborough Hall, 70 years planted, it is 30 ft. high. In Worcestershire, at Croome, 40 years planted, it is 20 ft. high.—In Scotland. In the environs of Edinburgh, at Gosford House, 80 years planted, it is 20 ft. high; at Hopetoun House, it is 35 ft. high. In Banffshire, at Gordon Castle, it is 30 ft. high. In Berwickshire, at the Hirsell, 30 years planted, it is 21 ft. high. In Haddingtonshire, at Tynningham, 72 years old, it is 17½ ft. high. In Perthshire, at Inverary, it is 28 ft. high; at Taymouth, 50 years planted, it is 36 ft. high; at Perth, in the nursery of Messrs. Dickson and Turnbull, 22 years planted, it is 12 ft. high. In Ross-shire, at Brahan Castle, 30 years planted, it is 20 ft. high. In Stirlingshire, at Airthrey, 43 years planted, it is 30 ft. high, the diameter of the head 18 ft.—In Ireland. In the environs of Dublin, in the Glasnevin Botanic Garden, 30 years planted, it is 16 ft. high; and at Cypress Grove, 30 years planted, it is 18 ft. high. In King's County, at Charleville Forest, 25 years planted, it is 20 ft. high. In the County Down, at Ballyleedy, 22 years planted, it is 16 ft. high. In Fermanagh, at Florence Court, 50 years planted, it is 26 ft. high. In Louth, at Oriet Temple, 30 years planted, it is 30 ft. high.—In France, near Paris, at Scéaux, 10 years planted, it 20 ft. high.—In Hanover, in the Göttingen Botanic Garden, 25 years planted, and from 30 ft. to 40 ft. high.—In Austria, at Vienna, in the University Botanic Garden, 20 years planted, it is 36 ft. high; at Laxenburg, 25 years planted, it is 20 ft. high; at Brück on the Leytha, 40 years planted, it is 30 ft. high.—In Prussia, at Berlin, at Sans Souci, 90 years planted, it is 14 ft. high; in the Frauen-Insel, 40 years planted, it is 14 ft. high.—In Sweden, at the Botanic Garden at Lund, it is 20 ft. high.—In Italy, at Monza, 24 years planted, it is 18 ft. high.

Commercial Statistics Seeds, in London, 4s. per lb. Plants, in the London nurseries, are from 6d. to 1s. each; at Bollwyller, 1 franc; and at New York, 50 cents.

‡ 2. *T. (o.) PLICATA* Donn. The plicate, or *Nee's*, Arbor Vitæ.

Identification. Donn Hort. Cantab., 6. p. 242; Lamb. Pin. ed. 2, 2. No. 61.; Lodd. Cat. ed. 1836.

Spec. Char., &c. Branchlets compressed, spreading. Leaves rhomboid-ovate; acute, adpressed, imbricated in 4 rows, naked, tubercled in the middle. Cones oblong, nodding. Seeds orbiculate. (*Lamb. Pin.*) A native of Mexico, where it was found by Nee; and of the western shores of North America, at Nootka Sound, where it was found by Menzies. Introduced into Britain by the last botanist, in 1796.

Description, &c. A very branchy, spreading, light green tree. Branches crowded, covered with a reddish brown bark; branchlets dense, often divided, pectinate, compressed. Leaves rhomboid-ovate, acute, closely adpressed, imbricated in 4 rows, crowded together between the nodes; glabrous, quite entire, shining, tubercled in the middle. Cones scattered, solitary, nodding, oblong: scales elliptic, obtuse, flat, obsolete furrowed. Seeds compressed, winged all round, emarginate at the apex, orbiculate-oblong. (*Lamb.*) There are plants in the Horticultural Society's Garden, at Messrs. Loddiges, and in other collections in the neighbourhood of London, where it has every appearance of being a variety of *T. occidentalis*, of which we, at least, have no doubt.

‡ 3. *T. CHILENSIS* Lamb. The Chili Arbor Vitæ.

Identification. Lamb. Pin. ed. 2, 2. p. 128, No. 63.

Synonyme. *Cupressus thuyoides Favon MSS.*

Spec. Char., &c. Branchlets jointed, spreading, compressed. Leaves ovate-oblong, obtuse, somewhat 3-angled, imbricated in 4 rows, adpressed, naked, furrowed on both sides. Cones oval-oblong; scales 4, compressed, elliptic, obtuse. Seeds winged at the apex, entire. (*Lamb. Pin.*, ii. No. 62.) A native of Chili, on the Andes; where it was found by Nee and by Favon. Not yet introduced.

Description, &c. A beautiful, dark green, spreading tree. Branches numerous, drooping, and covered with a greyish-brown bark. Branchlets crowded at the apices of the branches, often divided, compressed, articulated. Leaves oval-oblong, obtuse, somewhat trigonous, imbricated in 4 rows, adpressed, naked, somewhat distant; internodes distinct, especially in adult ones; glabrous, marked near the edge on both sides with a whitish, broad, depressed furrow, closely joined at the base, sheathing the branchlets. Cones numerous, terminal, drooping, oblong, compressed, 4-valved; exterior valves ovate-oblong, boat-shaped, pointed, externally convex; interior 2, opposite, spatulate, flattened at the apex, roundish, having a smaller nearly obsolete tubercle sometimes fertile. Seeds 2, sometimes inserted into the base of the interior valves, having a head scarious and membranaceous, very blunt; wing at the apex, decurrent at the base.

§ ii. *Biota*.

‡ 4. *T. ORIENTALIS* L. The Oriental, or Chinese, Arbor Vitæ.

Identification. Lin. Sp., 1422; Willd. Sp. Pl., p. 503; Baum., p. 505; Du Roi Harbk., 2. p. 458; Thunb. Jap., p. 266; Hort. Cliff., 449; N. Du Ham., 3. p. 11; Rich. Conif., p. 40.
Engravings. Dend. Brit., t. 149; Rich. Conif., t. 7. f. 2; and Gmel. Fl. Sib., l. p. 182; Smith in Rees's Cyc.; and our fig. 2315.

Spec. Char., &c. Branchlets 2-edged. Leaves imbricated in 4 rows, ovate-rhomboid, adpressed, furrowed along the middle. Cones elliptic; interior scales blunt, mucronate beneath the apex. (*Willd.*) A low tree, or fastigate

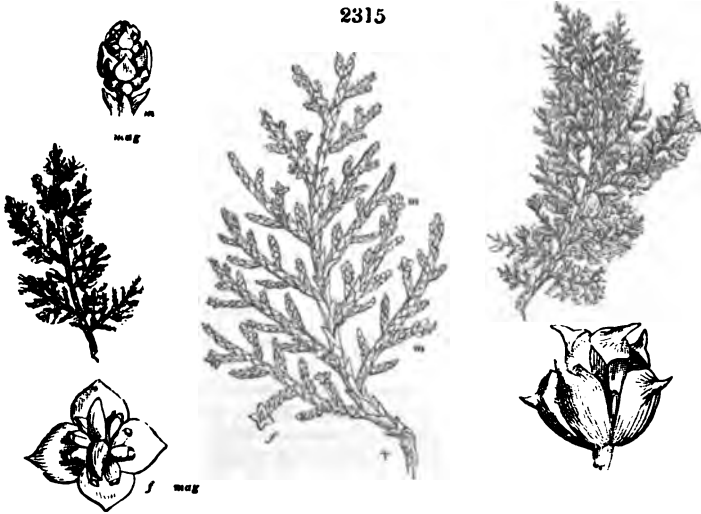

shrub; a native of rocky situations in China and Siberia; and also, according to Thunberg, on the mountains of Japan. (*Fl. Jap.*, 266.) Introduced in 1752, and flowering in May.

Varieties.

‡ *T. o. 2 stricta* Hort.; *T. pyramidalis* *Bauh. Cat.*, ed. 1837; and the plate of this tree in our last Volume, from the specimen in the Horticultural Society's Garden; is more fastigate than the species in its habit of growth, and forms a tall narrow shrub, or low tree.

■ *T. o. 3 tatarica*, *T. tatarica* *Lodd. Cat.*, ed. 1836, has the leaves, and the entire plant, rather smaller than the species. There is a plant in the Horticultural Society's Garden, 6 ft. high.

Description. A low tree or large shrub, distinguishable at first sight from the American arbor vitæ, by its more dense habit of growth, by its branches being chiefly turned upwards, and by its leaves or scales being smaller, closer together, and of a lighter green. The common height of full-grown trees of this species is from 18 ft. to 20 ft. The trunk is straight, with a brownish and somewhat rough bark; the branches are numerous, pointing outwards, so as to form almost a right angle with the stem; but soon afterwards they are turned upwards, in a direction almost parallel to the trunk. The leaves are flattened, and of a darker green in winter than in summer: they are imbricated, opposite, small, obtusely pointed, adpressed against the petioles, convex, furrowed at the back, and furnished with a clear green, smooth, shining gland. The male catkins are somewhat elongated, about 2 lines in length, composed of pointed scales disposed in 4 ranks. The female catkins are roundish, somewhat elongated, and composed of scales pointed at their summit,

which is recurved. When mature, the scales are thick, fleshy, rough, and opening lengthwise. The seeds are naked, ovoid, somewhat angular, reddish brown, and containing a kernel of the same form, but white. The fruit remains on the tree during winter, and opens and sheds its seeds with the first warm weather of spring. It is a native of China and Japan; and, according to Miller, it was first sent to Europe by the French missionaries. It has been in cultivation in England since 1752, and is a more compact-growing and handsomer species than the American arbor vitæ. It is quite hardy in the climate of London, where, in fine seasons, it ripens seeds. These are generally sown in pots immediately after they are gathered in autumn, in which case the plants come up the following summer; but, if the seeds are not sown till spring, they frequently do not come up for a year. Layers generally require two years to root sufficiently; and cuttings are rather more difficult to strike than those of *T. occidentalis*. In a young state, the plants are somewhat tender; but they become quite hardy when old, even in the climate of Edinburgh. The largest trees of this species in the neighbourhood of London are at Syon, and are nearly 20 ft. in height; there are also large trees on both sides of the road between London and Turnham Green.

Statistics. In the environs of London. At Mount Grove, Hampstead, 18 years planted, it is 14 ft. high, the diameter of the head 8 ft.; at Ham House, Essex, it is 25 ft. high, the diameter of the trunk 1 ft. 6 in., and that of the head 23 ft. — South of London. In Surrey, at Farnham Castle, 50 years old, it is 45 ft. high, the diameter of the trunk 2 ft. 4 in., and that of the head 30 ft.; at Claremont, it is 30 ft. high, the diameter of the trunk 1 ft., and of the head 15 ft.; at Nutfield, it is 24 ft. high, and the diameter of the head 17 ft. In Sussex, at Westdean, 11 years planted, it is 14 ft. high, the diameter of the trunk 8 in., and of the head 8 ft. In Bedfordshire, at Southill, 22 years planted, it is 25 ft. high. In Berkshire, at Bear Wood, 12 years planted, it is 15 ft. high. In Denbighshire, at Llanbede Hall, 15 years planted, it is 21 ft. high. In Staffordshire, at Teddesley Park, 14 years planted, it is 14 ft. high. In Warwickshire, at Coomb Abbey, 60 years planted, it is 31 ft. high. In Worcestershire, at Croome, 30 years planted, it is 20 ft. high. — In Scotland. In the environs of Edinburgh, at Gosford House, 14 years planted, it is 10 ft. high. In Ayrshire, at Auchencruive, 40 years planted, it is 20 ft. high. In Perthshire, at Taymouth, it is 40 ft. high. In Stirlingshire, at Callendar Park, it is 23 ft. high. — In Ireland. In the environs of Dublin, in the Glasnevin Botanic Garden, 30 years planted, it is 15 ft. high; at Cypress Grove, it is 15 ft. high. — In France. At Paris, in the Jardin des Plantes, 35 years planted, it is 36 ft. high; at Scéaux, 10 years planted, it is 20 ft. high. In the Botanic Garden at Toulon, 36 years planted, it is 29 ft. high; at Nantes, in the nursery of M. Nerrières, 40 years old, it is 29 ft. high, the diameter of the trunk 8 in.; at Avranches, in the Botanic Garden, 40 years planted, it is 29 ft. high, the diameter of the trunk 1 ft., and of the head 16 ft. — In Hanover, in the Göttingen Botanic Garden, 20 years planted, it is from 8 ft. to 16 ft. high. — In Austria, at Vienna, in the University Botanic Garden, 35 years planted, it is 30 ft. high; at Bruck on the Leytha, 40 years planted, it is 20 ft. high. — In Prussia, at Berlin, at Sans Souci, 90 years planted, it is 20 ft. high; in the Pfauen-Insel, 6 years planted, it is 10 ft. high. — In Sweden, in the Botanic Garden at Lund, it is 10 ft. high. — In Italy, at Monza, 24 years planted, it is 20 ft. high.

Commercial Statistics. Price of plants, in the London nurseries, 1*s.* 6*d.* each; at Bollwyller, 1 franc; and at New York, 50 cents.

§ iii. *Cyparîssa.*

5. *T. CUPRESSOIDES* L. The Cypress-like, or African, Arbor Vitæ.

Identification. Willd. Sp Pl., 4, p. 510.; Lin. Mant., 125.; Thunb. Prodr., 110.; N. Du Ham., 3, p. 16.; Ait. Hort. Kew., ed. 2., 5, p. 322.

Synonyme. *T. sphylla* Burm. Prodr., 27.

Engraving. Our fig. 2316. of the natural size.

Spec. Char., &c. Branchlets round. Leaves imbricated in 4 rows, oblong, depressed, smooth. Cones globose, somewhat 4-angled. (*Willd.*) A native of the Cape of Good Hope. Introduced into Kew Gardens, by Dr. Roxburgh, in 1799. Fig. 2316., of the natural size, is from a specimen of a young plant which bears the name of *Thuja cupressoides* in some of the nurseries; but, as none of the plants exceed 2 ft. in height, and very little is known of their origin, the correctness of the application of the name may reasonably be doubted.

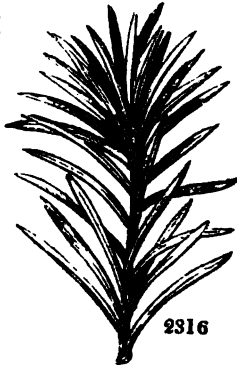

2316

6. *T. PENNSILIS* Lamb. The pensile Arbor Vitæ.

Identification. Staunt. Embosa, p. 436.; Lamb. Pin., 2., No. 63.

Spec. Char., &c. Leaves alternate, 3-rowed, trigonous, awl-shaped. Cones obovate. Scales cuneate, tubercled. Branches filiform, erect (*Lamb. Pin.*). A native of China, whence Sir Geo. Staunton brought specimens to England, but there are no living plants in the country.

Description, &c. An elegant much branched tree. Branchlets crowded, filiform. Leaves scattered, 3-rowed, spreading, trigonous, acutely keeled, mucronulate, 2—3 lines long, light green; younger ones closer at the apex of the branchlets, shorter, adpressed. Galbulus pear-shaped, large, many-valved; scales wedge-shaped, thick, woody, muricate externally; margin crenated. Seeds winged at the apex. (*Lamb.*)

‡ 7. *T. PENDULA* Lamb. The pendulous, or weeping, Arbor Vitæ.

Identification. Lamb. Pin., ed. 2, 2 t. 67.

Engravings. Lamb. Pin., ed. 2, 2 t. 67.; our fig. 2318. to our usual scale; and fig. 2317. of the natural size.

- Spec. Char., &c.* Leaves opposite and decussating, spreading, lanceolate, mucronulate, keeled, somewhat distant. Cones globose. Scales convex, smooth. Branches filiform, pendulous. (*Lamb. Pin.*, ii. t. 67.) Branches very long, hanging down in the most graceful manner; light green. Cones globose, about the size of a wild cherry, 6-valved; valves roundish, very thick, fungous, externally convex, smooth. A native of Tartary, probably, Mr. Lambert thinks, from that part of it which is included within the Chinese empire; as it is nearly related to *T. pensilis*, which is known to come from that part of Tartary. Mr. Lambert's plant was kept in the conservatory at Boyton; and he says, writing in 1832, that it is perhaps the only one in Europe. He received it from Messrs. Loddiges, and has since given it to Mr. Anderson of the Botanic Garden, Chelsea, where it is kept in the green-house; and, when we saw it in 1837, it was about 6 ft. high. Cuttings have been struck from the plants in the Chelsea Botanic Garden, and they have stood at Dropmore in the open air for two or three winters. There is a cupressinous plant, without a name, evidently of the same species as that at Chelsea, in the arboretum at Kew, which, in December, 1837, was upwards of 10 ft. high. Dr. Wallich, in 1830, is said to have recognised this plant as a native of Nepal, but he does not appear to have given it a name. In 1835 it bore fruit, which, Mr. Smith informs us, closely resembled that of a *Juniperus*; and indeed we have little doubt, from the foliage of the plant, that it is likely to prove either a *Juniperus* or a *Cupressus*; at all events, we do not think it can be a *Thuja*, two-edged branchlets being in our opinion essential to that genus. But whether a *Cupressus* or a *Juniperus*, or, what is not unlikely, worthy to be considered as a distinct genus, this plant deserves to be extensively cultivated, and introduced into every collection. Its long, slender, pendulous shoots bear no resemblance to the branches of any other species of *Cupressinæ*; and the fruit, though considered as that of a juniper, does not, in our opinion, present an insurmountable barrier to the identification of the Kew plant with the one figured by Lambert, since the berried appearance in *Juniperus* is merely

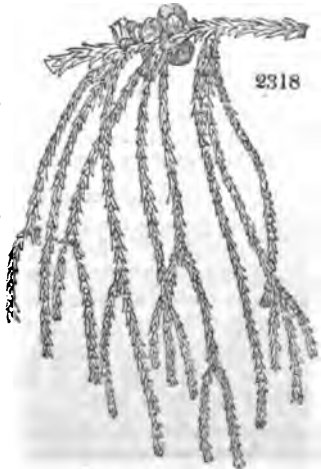

owing to the scales which compose the cone being more closely adpressed than they are in *Cuprèssus*. In some species of *Juniperus*, and in some individual berries of other species, such as *J. phœnicea*, *J. drupacea*, &c., the scales appear quite distinct, and they terminate in horny-looking prickles or appendages, which give the fruit fully as much the appearance of a *Cuprèssus* as of a *Juniperus*.

App. i. *Species not sufficiently known to be referred to any of the preceding Sections.*

T. filiformis Lodd. Cat., ed. 1836. There are plants in the Hackney arbo-retum, but they are too small to enable us to determine anything respecting them.

T. dolabrata Lin. Suppl., p. 420, Thunb. Jap., p. 266, Willd. Sp. Pl., 4 p. 509, Lamb. Pin. ed. 2., t. 68, from a specimen in Kœmpfer's herbarium, at the British Museum; *Quai*, vulgo *Pi no ki*, and *Ibuki*, Kœmpf. Amœn., p. 684. Branchlets 2-edged. Cones squarrose. Leaves broad-ovate, obtuse, imbricated in 3 rows, white, and hollowed beneath. (*Lamb. Pin.*) A large, lofty, and very handsome tree. Branchlets very numerous, alternate, flattened, irregularly divided. Leaves imbricated in 3 rows, ovate, obtuse, thick, much larger than in the other species; convex above, of a beautiful green, shining, furrowed in the middle; concave, margined, and white beneath. Cones squarrose. A native of Japan, where Thunberg observed it in the countries of Orygwa and Fakonia, between Misao and Jedo, and found it planted along the high road on the hill of Fakonia. He speaks of it as a tree of vast height and dimensions, the most beautiful of all the evergreen tribe, but it has not yet been introduced. Mr. Lambert states that he has no doubt of its being perfectly hardy.

Other Species. There are various names in nursery catalogues, but the plants to which they are applied bear so close a resemblance to those already described, that we cannot venture to consider them distinct.

GENUS X.



CA'LLITRIS Vent. THE CALLITRIS. *Lin. Syst. Monœ'cia Monadélphia.*

Identification. Vent. Dec. Nov. Gen.; R. Brown in Litt.; Richd. Mém. sur les Conifères, p. 141.

Synonymes. Thùja, part of, *Linn.*; *Fresnèlis* Mirbel Mém Mus.

Description, &c. Evergreen low trees, natives of Africa and Australia, and requiring, in England, the protection of a green-house. This genus was established from the *Thùja articulata* of Desfontaines. It differs from the genus *Thùja* in having the scales of the female catkins constantly from 4 to 6, all opening like the valves of a regular pericarp; and in having, at the base of each of these scales, a number of seeds winged on the margin.

‡ 1. *C. QUADRIVALVIS* Vent. The four-valved Callitris.

Identification. Ventenat, Dec. Nov. Gen.; Rich. Mém. sur les Conifères, p. 46.

Synonymes. *Thùja articulata* Desf. Atl., 2 p. 353, *Arb. et Arbust.*, 2 p. 576, *Willd. Sp. Pl.*, 4 p. 506, *N. Du Ham.*, 3 p. 15; *Cuprèssus fructu quadrivalvi* Shaw *Afric.*, No. 188, icon;

Thùja stròbilis tetragònia, &c. *Vahl Symb.*, 2 p. 96.

Engravings. Shaw, 1 c., icon; Vahl *Symb.*, t. 48; Desf. Atl., 2 t. 252, *N. Du Ham.*, 3 t. 5, Lodd. *Bot. Cab.*, t. 844, and our fig. 2319. from specimens received from M. Otto of Berlin.

Spec. Char. Leaves flattened, articulate. Female catkin tetragonal, with 4 oval valves, each furnished with a point, and 2 of which bear seeds. (*Desf.*) A low tree; a native of Barbary. Introduced in 1815, and flowering from February to May.

Description, &c. A tree, attaining the height of from 15 ft. to 20 ft., according to the soil and situation in which it grows, with a trunk from 1 ft. to 3 ft. in diameter. Branches forming an open angle with the trunk, with numerous smaller shoots, flattened, striated, articulated, fragile, and of a green colour. Articulations enlarged at their summit; about 3 lines in breadth, and from 9 to 10 lines in length. Leaves very small; straight, unequal, and mucronate, with very small glands at their base. Flowers monœcious. Male

catkin a small cone, somewhat pendent, obtusely tetragonal. Scales disposed in four ranks, pediculate, buckler-shaped, and of a pale yellow. Anthers 3 or 4 at the base of each scale; sessile, somewhat rounded. Female catkins solitary, and situated at the summit of the branches. Cone tetragonal, with obtuse angles; scales 4, woody, thick, heart-shaped, hollowed longitudinally on their exterior surface, convex on the interior, and open from the base to the summit; the two large opposite scales bearing seeds, and the two small ones sterile. Seeds few, small, and with

a wing at the side. A native of Mount Atlas, and of other uncultivated hills on the coast of Africa, where it was discovered by Desfontaines, and seeds sent to the Jardin des Plantes, about 1796. The trees seen by Desfontaines in Algiers were only from 15 ft. to 20 ft. high; but Broussonet states that he had seen larger ones in the kingdom of Morocco. In the climate of Paris, it requires the protection of the conservatory during winter. In the conservatory of the Botanical Garden, at Berlin, there is a plant 15 ft. high, which flowers and fruits every year, but the seeds do not germinate. *Cállitris quadriválvis* was introduced into England in 1815; and there are plants at Messrs. Loddiges's, where, trained against the wall of one of their green-houses, it grows vigorously, and in January, 1832, flowered for the first time in this country. There are also plants in some other collections, but it is by no means common. In the kingdom of Morocco, according to Broussonet, this tree produces the gum sandarach of commerce. This substance is in tears, clear, shining, diaphanous, of a whitish yellow, and free from impurities. Dissolved in the spirit of wine, it produces a delicate varnish, easily scratched; reduced to a fine powder, it forms a very superior kind of pounce, and is applied to paper and parchment to make them bear ink. It was for a long time thought that the gum sandarach was obtained from some species of *Juniperus*. Captain S. E. Cook, in his *Sketches in Spain*, vol. ii., has brought to light the interesting fact, that the woodwork of the roof of the celebrated mosque, now the cathedral of Cordova, which was built in the ninth century, was of the wood of this tree. It had been previously thought to be that of the larch, from the resemblance of the Spanish word *alerce*, which is applied to the wood of *Cállitris quadriválvis* in Spain and Barbary, to the Latin word *larix*; whence the English word larch. The larch, however, is not found in any part of Spain. After carefully examining the wood in question, and comparing it with the timber of the roofs of the Alhambra, the Alcaza, or Royal Palace of Seville, and other remains of the Moors in Andalusia, the roofs of which are of the *Pinus Pínea*, or stone pine, once extensively grown in Andalusia, Captain Cook came to the conclusion, that the origin of the timber of the mosque must be sought elsewhere, and that it was not of any Spanish or even European, tree. "By a singular coincidence, the subject had been undergoing investigation about the same time in Africa. Mr. Drummond Hay, the British consul at Tangier, had, by tracing the Arabic etymology of the word *alerce*, by availing himself of the extensive botanical researches of the late Mr. Schawboe, the Danish consul in Morocco, and by collating the accounts of the resident Moors, made out that the *alerce* was the *Thuja articulata*, Desf. (*Cállitris quadriválvis Vent.*), which grows on Mount Atlas, in the

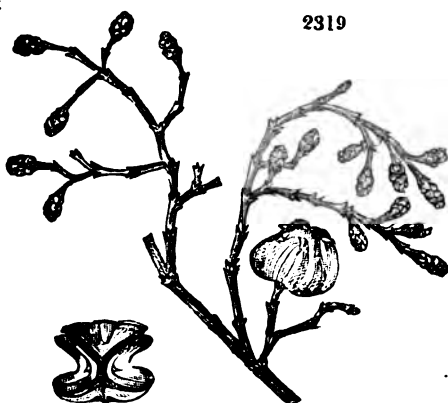

vicinity of Tangier. In corroboration of his views, a plank of the timber in question was transmitted to London. This plank, which is still in the rooms of the Horticultural Society, in Regent Street, is 1 ft. 8 in. in diameter; and Captain Cook says that he is perfectly satisfied of its identity with the parts of the timber of the mosque at Cordova which he examined. It is highly balsamic and odoriferous; the resin, no doubt, preventing the ravages of insects, as well as the influence of the air. There is reason to believe that it was the sandal wood of the Orientals, and that this species was employed, whenever it could be procured, in the construction of their religious edifices. Captain Cook adds that he sees no reason to apprehend that this species, which is nearly allied to the Italian cypress (*Cuprèssus sempervirens*) and the juniper of the south of Europe (*Juniperus phœnicea*), should not be as hardy as its congeners, which are natives of similar latitudes, and which grow as well in the warmer parts of England, as in the south of Europe." (*Gard. Mag.*, xiii. p. 523.) He therefore strongly recommends a trial of the tree in the open air in this country. At present, plants are rather scarce, but they might easily be increased by cuttings, or by importing seeds from Morocco.

‡ *C. Fothergillii*, ? *Cuprèssus Fothergillii*. There are young plants of this name at Elvaston Castle, and in some of the nurseries, which in general appearance resemble the common evergreen cypress.

‡ *C. triquetra*, *Cuprèssus triquetra* Lodd. *Cat.*, ed. 1836, is a native of the Cape of Good Hope, introduced in 1820. There are plants at Messrs. Loddiges's, and also at Elvaston Castle, where it has stood out three years, and appears quite hardy.

‡ *C. cupressiformis* Vent., *Lond. Hort. Brit.*, p. 490., is a native of New Holland, introduced in 1826. There are small plants of it in various nurseries.

‡ *C. macrostachys* Hort. There is a plant at Elvaston Castle.

App. i. *Species of Cálitris Natives of Australia, and not yet introduced into Britain.*

C. rhomboides R. Brown, *Rich. Conif.*, p. 47. pl. 118. No. 1. A low tree, with the habit of a cypress, and thin articulated branches. The leaves are imbricated, and closely adpressed to the branch. The female catkins are small, solitary, and terminal. It is a native of New Holland, whence specimens were brought by Mr. Brown, and communicated by him to M. Richard.

C. oblonga Rich. *Mém. sur les Conif.*, p. 49. pl. 18. No. 2. *C. fruticosa* R. Brown, has the nut dry and opening, like that of the preceding species, but much larger. It is a native of Fort Jackson, and specimens were brought home by Mr. R. Brown.

GENUS XI.



CUPRÈSSUS L. THE CYPRESS. *Lin. Syst. monœcia Monadelphica.*

Identification. *Lin. Gen.*, No. 1079.; *Reich.*, 1177.; *Schreb.* 1428.; *Gertn.*, t. 91.; *Tourn.*, t. 386. *Juss.* 413.; *Lamb. Pin.*, ed. 2.

Synonymes. *Cypres*, *Fr.*; *Cypresse*, *Ger.*; *Cipresso*, *Ital.*; *Cipreste*, *Port.*; *Cyproa*, *Hungaria.*

Derivation. According to some, from *κυσ*, to produce, and *πριαος*, nearly resembling; in allusion to the regularity of the branches; or from *Cyparissus*, a beautiful youth of the Island of Ceos, who was changed into a cypress; or, according to others, from the Isle of *Cyprus*, where one species of the tree was found in abundance.

Description. Evergreen low trees; natives of Europe, Asia, and North America; remarkable for the fine grain and durability of their wood.

‡ *C. SEMPERVIRENS* L. The common, or evergreen, Cypress.

Identification. *Willd. Sp. Pl.*, 4. 511.; *Rall Hist.*, 1406.; *Gouan Mon.*, 495.; *Mill. Dict.*, No. 1.; *Scop. Carn.*, No. 1199.; *Fabric. Helms.*, 442.; *Regn. Bot.*; *Hort. Cliff.*, 449.; *Hort. Ups.*, 288.; *Roy Londb.*, 88.; *Tourn. Inst.*, 587.; *Bauh. Pin.*, 488.; *Cam. Epit.*, 52.; *N. Du Ham.*, 3. p. 2.; *Lam. Dict.*, 1.; *Lodd. Cat.*, ed. 1836.; *Bon Jard.*, ed. 1837.; *Laws. Man.*, p. 360.

Synonymes. *C. pyramidalis* *Hort.*; *Cypres pyramidal*, *Cypres ordinaire*, *Fr.*; *gemeine Cypressenbaum*, *Ger.*; the Italian Cypress.

Engravings. *Dend. Brit.*, t. 155.; *N. Du Ham.*, 3. t. 1.; *Lob. Icon.*, 2. p. 222.; *Blackwall's Herb.*, 127.; our *fig.* 2330.; and the plates of this tree in our last Volume.

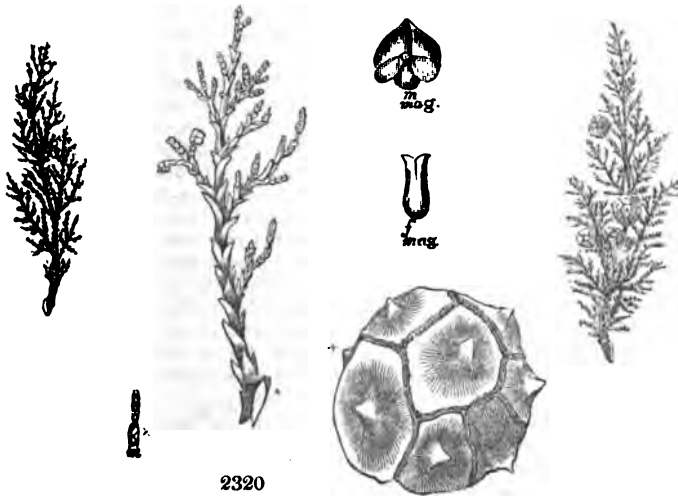

Spec. Char., &c. Branchlets quadrangular. Leaves imbricated in 4 rows, obtuse, adpressed, convex. Cones globose; scales nutic. Branches straight. (*Willd.*) An evergreen tree, a native of the south of Europe. Introduced before 1548.

Varieties.

- † *C. s. 1 stricta* Mill. Dict., *Cyprés mâle, Fr.*, has the branches upright, and closely pressed towards the trunk; and is the most common form of the species. (See the plate of *C. sempervirens* in our last Volume.)
- † *C. s. 2 horizontalis* Mill. Dict.; *C. horizontalis N. Du Ham.*, 3. p. 6.; *C. expansa Hort. Par.*; has the branches spreading. (See the plate of this tree in our last Volume.) In the *Nouv. Du Hamel*, it is stated that there is a very fine specimen of a horizontal cypress, which is quite a distinct species, received from the Levant, in the Botanic Garden at Montpellier, which has borne seeds, from which young plants quite true to the parent have been raised. There is a tree in the Horticultural Society's Garden, which is named *C. s. horizontalis*, 12 ft. high, and received about 1825, from Godefroy, near Paris; and another named *C. horizontalis*, received from Audibert's Nursery, in the south of France, also in 1825, but which is only 6 ft. high. Mr. Gordon considers them to be quite distinct; but they appear to us to be the same. There is, also, in the Horticultural Society's Garden, a cypress, received from Messrs. Audibert in 1835, under the name of *C. expansa*; but we do not know whether it is the *C. expansa Hort. Par.*, and it is at present too small, for us to determine whether it is the same as M. Audibert's *C. horizontalis*.

Description. The evergreen cypress is a flame-shaped, tapering, cone-like tree, with upright branches growing close to the trunk, and resembling in general appearance the Lombardy poplar; but, even in its native country, rarely rising above the height of 50 ft. or 60 ft., though it is sometimes found much higher. Its frond-like branchlets are dichotomous, and are closely covered with very small imbricated leaves, which, when old, become more distinct, diverging, and sharp-pointed: they are of a yellowish green, smooth, shining, and persistent, remaining on the tree for 5 or 6 years. The male catkins are yellowish, about 3 lines long, and very numerous. The female catkins are much fewer, and of a roundish-oblong form. The cone, or nut, which was called by

Varro *galbulus*, is from 1 in. to 1½ in. in diameter, sessile, and generally produced in pairs, on the sides or at the extremities of the branches; it ripens during the winter, and opens with the first warmth of spring. The cone is composed of large, angular, corky scales, slightly convex on the outside, streaked in rays, and mucronate in the centre; becoming woody and separating when ripe; on the inside, ending in a thick angular peduncle, to the extremity of which adhere 4 little nuts, which are bony, obovate, compressed, or irregularly angular, and covered with a thin membranaceous skin of a dun colour. The seed is of a bay colour, and of a linear-oblong shape. The wood is hard, fragrant, and of a remarkably fine close grain, very durable, and of a beautiful reddish hue, which Pliny says it never loses. Du Hamel says that he has observed on the bark of young cypresses small particles of a substance resembling gum tragacanth, and that he has seen bees taking great pains to detach these particles, probably to supply the glutinous matter used by them in forming their combs. The rate of growth, in the climate of London, will average, for the first 8 or 10 years, from 1 ft. to 1 ft. 6 in. a year; after which the tree grows more slowly; and, when it has attained its full size, and is between 30 ft. and 40 ft. high, it will live many years without any perceptible increase in dimensions. The largest, and probably also the oldest, evergreen cypresses in the environs of London, are at Syon, where there is one tree (probably one of those planted there by Dr. Turner, in the reign of Henry VIII.) upwards of 52 ft. high. A tree, probably contemporary with this, is now in ruins in the park at Ditton, near Windsor, said to have been



2321

planted by Cardinal Wolsey. The trunk is 8 ft. in circumference; but the head and branches are in a state of great decay. There are some very fine specimens at Croome, of two of which *figs.* 2321. and 2322. are portraits, kindly presented to us by Miss Radcliffe of Worcester. *Fig.* 2321. is a portrait of *C. s. horizontalis*, which, in 1836, after being 30 years planted, was 65 ft. high; and *fig.* 2322. is a portrait of one of several trees of *C. s. stricta*, which, after being 40 years planted, was 35 ft. high. The largest, the oldest, and, doubtless, the most celebrated evergreen cypress in the world, is that at Soma, in Lombardy, which has been already noticed in p. 169., and of which a portrait and the history will be given in a future page.



2322

Geography. The common evergreen cypress is a native of the islands of the Archipelago; particularly Candia (the ancient Crete) and Cyprus. It is also a native of Greece and Turkey, and of Persia and Asia Minor. It is found apparently wild in Italy; but Pliny tells us that it was introduced into that country from Greece, and first planted there in the environs of Tarentum. Desfontaines states that he has seen it growing on Mount Atlas, and in some of the gardens at Algiers. It was found in great abundance on Mount Ida, and also, as is mentioned in the *Bible*, on Mount Sion. It flourishes in various soils and surfaces, from moist bottoms to dry rocky precipices; but it is always found of largest size in soils which are deep and sandy, rather dry than moist, somewhat sheltered, and at no great elevation above the level of the sea.

History. The upright cypress is mentioned in Holy Writ, in the Book of Ecclesiasticus:—"I am exalted like the cedar in Lebanon, and like a cypress on Mount Sion." The gopher wood, of which the ark was made, is also supposed by some to be cypress. This tree was known both to the Greeks and Romans. Herodotus tells us that the Egyptians made their mummy-cases of the wood. Theophrastus states that it grew naturally in the Isle of Crete, on the mountains covered with snow (*Hist.*, lib. iv. c. 1.); and that it would not thrive in situations that were too warm. He adds that those who wish to have the cypress flourish, must procure a little of the earth of the Isle of Cyprus for it to grow in. (Lib. v. c. 2.) Thucydides says that the Greeks who died for their country had their ashes preserved in cypress. According

to Theophrastus, it was dedicated to Pluto; because the tree, when cut down, never throws up suckers; and hence also, perhaps, the custom mentioned by Horace, of shutting up in the tomb with the dead a branch of cypress, and enveloping the body in its fronds; though some suppose it to have originated in the supposition that the balsamic odour of the cypress would neutralise the infectious exhalations proceeding from the corpse. Among the Romans, many authors mention this tree. Pliny tells several extraordinary stories respecting the durability of its wood; the statue of Jupiter in the Capitol, which was formed of cypress, had existed above 600 years, without showing the slightest symptom of decay; and the doors of the temple of Diana at Ephesus, which were also of cypress, when 400 years old, had the appearance of being quite new. He also says that, in his time, the wood was used for many rural purposes, particularly for vine-props, for which the wood of the horizontal variety was preferred. He adds that the plantations of cypress were cut down every 13 years, for poles, rafters, and joists; which made the wood so profitable, that a plantation of cypress was thought a sufficient marriage portion for a daughter; and, hence, the tree was sometimes called "dos filiæ." (*Plin.*, lib. xvi. c. 33.) In another place, he informs us that the Romans made verdant walls of cypress in their gardens; and also that they clipped the entire trees into a variety of forms, so as to represent a chase, a fleet of ships, and numerous other fancies. He adds that, in his time, there were standing at Rome some cypresses that were more ancient than the city itself. Plato had his code of laws engraved on cypress wood, as being more durable than brass. Vitruvius and Martial also speak of the great durability and beauty of cypress timber. Columella mentions the various rural uses of the cypress wood; and Cato (*De Re Rustica*) gives directions for making plantations of cypress trees, recommending the planters to procure the seed from Tarentum. The odour of the cypress was thought so balsamic, that the Eastern physicians used to send those of their patients who had weak lungs to the Isle of Crete. In the middle ages, we find this tree frequently mentioned. Leon Alberti, a celebrated Florentine architect of the fifteenth century, tells us that he found the wood of a vessel which had been submerged 1300 years, and which was perfectly sound, to be principally of cypress. The doors of St. Peter at Rome, which had lasted from the time of Constantine to that of Eugene IV. (that is, above 1100 years), were of cypress, and were found, when removed by Pope Eugene, to give place to brass, to be perfectly sound. The popes, in the middle ages, were buried in coffins of cypress wood, from the belief that it would never decay. The Turks plant cypress trees in their cemeteries, one at each end of the grave, when they inter their dead; and these are so numerous at Scutari, that the cemetery there (see *fig.* 2323.) resembles one vast forest of cypress. This magnificent burying-ground extends for miles in length; and, among high and turbaned tombstones, gold-lettered inscriptions, and graves ornamented with flowers, the tall evergreen cypress has a very striking effect. (*Alex. Trav.*, p. 240.) The cemetery at Pera (see *fig.* 2324.) is on a comparatively level surface: it is of great extent, bordered by the sea, and thickly set, in many places, with Turkish monuments, shaded by cypress trees.

The question as to whether the upright and spreading cypresses are the same, or two distinct kinds, has long engaged the attention of botanists. Theophrastus says that they degenerate into each other, and both bear seeds alike. Pliny supposes *C. s. horizontalis* to be the male, and *C. s. stricta* to be the female; and his opinion seems to have been adopted by most of the earlier botanists. Gerard calls the upright, the tame cypress; and the spreading, the wild; but Johnson, in his edition of Gerard, seems to have supposed the upright cypress to have been made so by art. Miller, writing nearly a century later, appears to be almost of the same opinion, as he says: "The cypresses were formerly planted in the borders of pleasure-grounds, and kept shorn into a pyramidal or conic form; and some people, believing them to be subject to be killed if they cut them, tied them up with cords into a pyramidal figure, which form they are

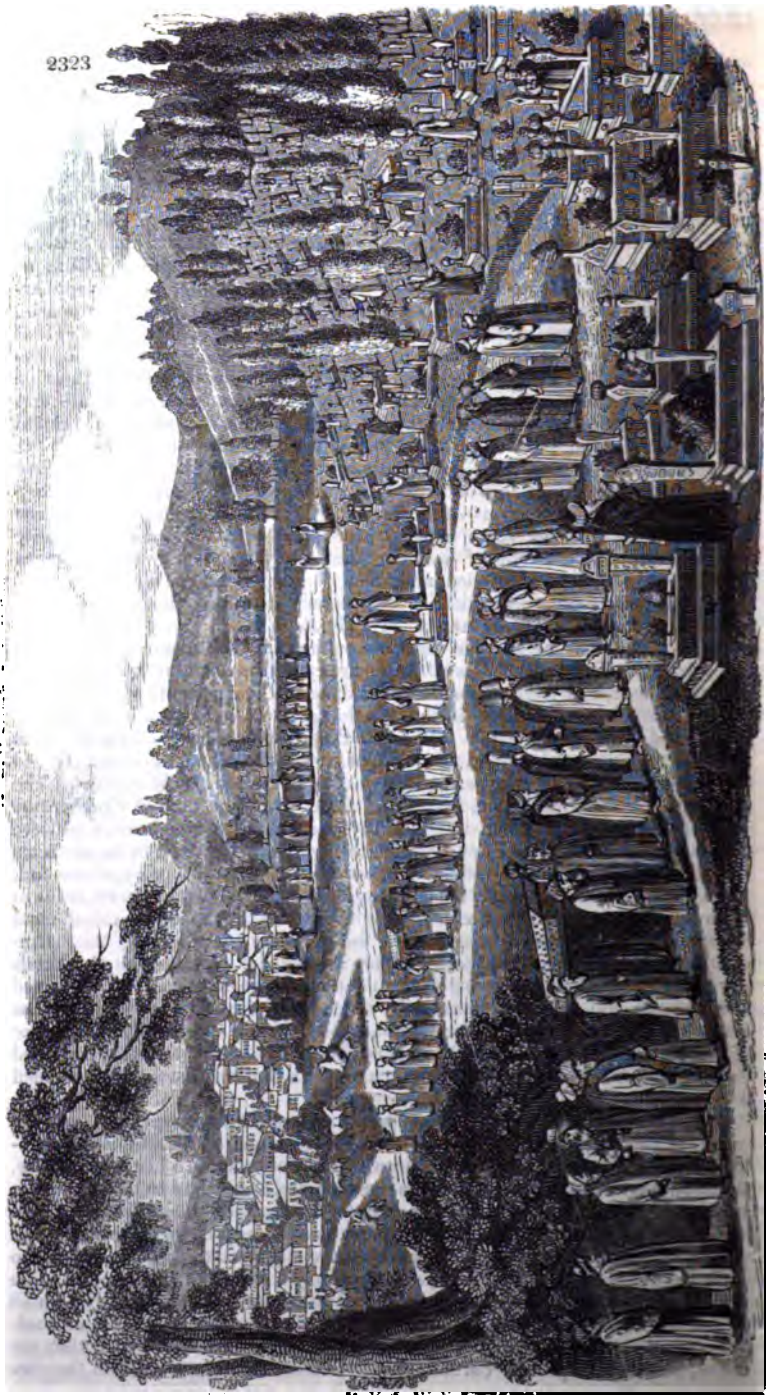



naturally disposed to grow in; but this winding them about prevented the air from entering the inward parts of the branches, so that the leaves decayed, and became unsightly, and greatly retarded their growth." Lamarck, Desfontaines, and some other French writers, assert that, if the seed of either variety be sown, the produce will consist partly of both kinds; but M. Fougereux, in a memoir read to the Royal Agricultural Society of Paris, in 1786, asserts that he has sown the seeds of both varieties repeatedly, and has always found them come true. He adds that the spreading cypress is hardier, and furnishes wood of a better quality, from the air getting free access among the branches, which it cannot do in the upright variety. Dr. Walsh, in his "Notes on the Botany of Constantinople," published in the *Horticultural Transactions* for 1824, is decidedly of opinion that *C. horizontalis* is a distinct species. "The character of the whole tree," he says, "is distinct and permanent. The branches project as horizontally as those of the oak; and the tree more resembles a pine than a cypress. It is in great abundance, mixed with *C. sempervirens*, in all the Turkish cemeteries. Whenever a Turk of respectability buries one of his family, he plants a young cypress at the head of the grave, as well because its aromatic resin qualifies the putrid effluvia of the place, as because its evergreen foliage is an emblem of immortality."

The exact date of the introduction of the cypress into England is uncertain; but Turner mentions it as "growing plenteously at Syon," in the edition of his *Names of Herbes* which was published in 1548, when Turner was physician at Syon; and Gerard, writing in 1597, mentions that there are trees of it at "Syon, a place neere London, sometime a house of nunnes. It groweth also at Greenwich, and at other places, and likewise at Hampstead, in the garden of Mr. Wade, one of the clerkes of Her Majesties prive councill." (*Herb.*, 1368.) As seeds are ripened abundantly in England, the tree has long been plentiful in British nurseries; and, in consequence, it has been so extensively distributed, that there is scarcely a suburban villa or a country seat in which it is not to be found. In France, in the climate of Paris, it can scarcely be considered as hardy, being killed to the ground by severe winters. It is, however, much cultivated there in pots and tubs, for the decoration of parterres and apartments, in the summer season. In this case, it is always neatly tied, so as to insure the permanence of its pyramidal form. In the south of France, as at Montpellier for example, it attains a large size; but in the north and throughout Germany, it is a green-house plant.



Remarkable Cypresses. Perhaps the oldest tree of which there is any record in the world is the cypress of Soma, or Somma, in Lombardy. This celebrated tree, of which *fig. 2325.* is a portrait (from an original drawing kindly sent to us by Signor Manetti of Monza), is generally supposed to have been planted the year of the birth of Jesus Christ, and on this account is treated with great reverence by the inhabitants of that part of Lombardy where it grows; but the Abbé Beléze informs us that there is an ancient chronicle extant at Milan, which proves that it was a tree in the time of Julius Cæsar, B. C. 42. (See p. 169.)

2326

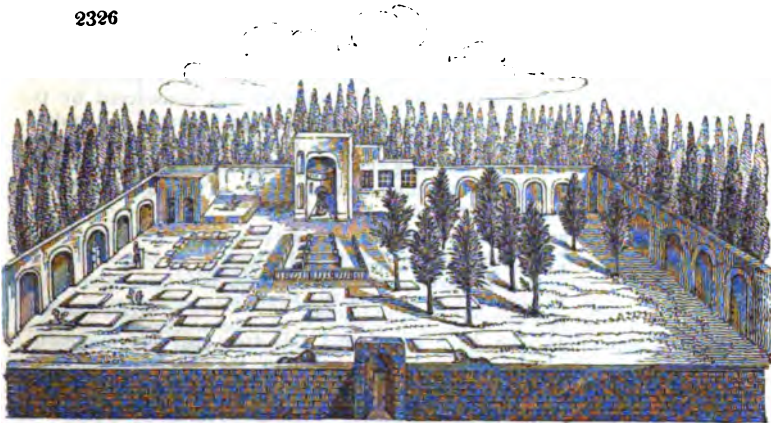

When measured for us by direction of Signor Manetti, this tree was found to be 121 ft. high, and 23 ft. in circumference at 1 ft. from the ground. Besides its great age, the cypress of Soma is remarkable for having been wounded by Francis I., who is said to have struck his sword into it, in his despair at losing the battle of Pavia; and for having been respected by Napoleon, who, when laying down the plan for his great road over the Simplon, diverged from the straight line to avoid injuring this tree.

The cypress of Hafiz, near Shiraz, is mentioned by several writers. Tavernier, in 1665, says that it required four men to embrace it. Chardin also mentions it; as does Johnson, who visited it in 1817. This tree is said by some to have been planted by the poet himself; and, by others, to have grown over his grave. In Kæmpfer's *Amœnitates Exoticæ*, &c., however, there is given a plate of the sepulchre of Hafiz (see fig. 2326.), from a Persian drawing; and, in the description, it is stated that Hafiz, who died in 1340, was buried in a square cemetery shaded by poplars, a rare tree in Persia; and that the wall which surrounded it was built to coincide in direction with the boundary of the cypress grove in the adjoining garden, which had belonged to the poet, and was bequeathed by him for the preservation of his cemetery. In this garden, probably, was the celebrated cypress alluded to by the travellers. The small tombstones shown in fig. 2326. are those of persons who wished to be buried under the guardian influence of the poet.

The cypresses of Chartreux were planted by Michael Angelo; and they were seen by M. Simond, who, in his *Travels through Italy* in 1817, visited the garden of the convent of the Chartreux, situated on the site of the baths of Dioclesian at Rome. There are three trees, all nearly the same size; and the trunk of the largest, when measured by M. Simond, was about 13 ft. in circumference.

Los Cypressos de la Reyna Sultana are mentioned by Hunter in his edition of Evelyn's *Sylva*, and by M. Loiseleur Deslongchamps, in his very able article on the cypress in the *Annales de la Société d'Horticulture de Paris*, vol. xv. These noble trees formed an avenue in the gardens of the palace of the Generalife at Granada; and under their shade the last Moorish king of Granada is said to have surprised his wife with one of the Abencerages, which led to the massacre of thirty-six princes of that race. These trees were still in existence in 1832, when (as according to the legend, they were large trees in 1490) they must have been nearly 400 years old.

The oldest and largest cypress in France is one near St. Remy, in Provence. When measured by MM. Audibert and Varrel, in October, 1832, it was 55 ft. 6 in. high, French (above 60 ft. English); the circumference of the trunk was 14 ft. (15 ft. 2 in.), and of the head 75 ft. (82 ft. 3 in.). This tree

is supposed to be 300 years old; and it is said that, when Philip, Infant of Spain, and son of Philip V., was defeated in Italy, in 1747, the remains of his army took refuge in Provence, and 22 of the Spanish soldiers hid themselves in this tree. (*Annales de la Soc. d'Hort. de Paris*, vol. xv. p. 41.)

Poetical and mythological Allusions. The cypress was considered by the ancients as an emblem of immortality, and, as such, was dedicated to the dead. It was also held sacred to Proserpine and Pluto. It was esteemed the emblem of immortality, from its being evergreen, and from its power of rising again when bent down by the wind, or manual force. This power is alluded to in the following lines from Statius:—

"The mountain cypress thus, that firmly stood
From age to age, the empress of the wood,
By some strong whirlwind's sudden blast declined,
Bends arching down, and nods before the wind:
The deep roots tremble till the blast blows o'er,
And then she rises stately as before."

HART'S *Statius*.

The ancient poets who have mentioned this tree are very numerous: Homer, Virgil, Ovid, Lucan, and many other of the poets of antiquity, make frequent allusions to it. Virgil frequently speaks of its use in funeral ceremonies, particularly at that of Misenus:—

"Ingentem struxere pyram: cui frondibus atris
Intexunt latera, et feras ante cupressos
Constituunt, decorantque super fulgentibus armis."

Æneid. vi. 215.

"And first with massy logs the pile they rear,
Spreading the gloomy fronds above with care.
In front, the tapering cypress rears its head,
And bears the shining armour of the dead."

The legend of the origin of the cypress is given by Ovid:—A beautiful stag, the favourite of Apollo, was accustomed to come every day to be fed by the god, or his faithful attendant, Cyparissus. One day, the youth was hurling his spear merely for exercise, when, unfortunately, it struck and killed the stag, which was coming bounding from the forest to Cyparissus, expecting to be caressed as usual. The youth's grief at this accident was so great, that Apollo endeavoured in vain to comfort him: he threw himself to the ground in despair,—

"Praying, in expiation of his crime,
Thenceforth to mourn to all succeeding time.
And now, of blood exhausted, he appears
Drain'd by a torrent of continual tears.
The fleshy colour in his body fades,
A greenish tincture all his limbs invades.
From his fair head, where curling ringlets hung,
A tapering bush, with spiry branches, sprung,
Which, stiffening by degrees, its stem extends,
Till to the starry skies the spire ascends.
Apollo saw, and sadly sighing, cried,
'Be, then, for ever what thy prayer implied.
Bemoan'd by me, in others grief excite,
And still preside at every funeral rite.'"

OTID, book x.

Claudian, in his poem of the *Rape of Proserpine*, says that the two torches which Ceres employed to seek her daughter were not pine trees, but two cypresses, which grew on Mount Etna.

Tasso, in his *Gerusalemme Liberata*, says,—

"Sorve a pari col sole, ed agli stesso
Seguir la pompa funeral poi volle;
A Dudon, d'odorifero cipresso,
Composto hanno un sepolcro a piè d'un colle."

Canto iii.

The following lines are by De Lille, in *Les Jardins*:—

— "Et toi, triste cyprès,
Fidèle ami des morts, protecteur de leurs cendres,
Ta tige, chère au cœur, mélancolique et tendre,
Laisse la joie au myrte, et la gloire au laurier.
Tu n'est point l'arbre heureux de l'amant, du guerrier,
Je le sais; mais ton deuil compatit à nos peines."

Among the English poets, from the time of Spenser to the present day, the allusions to the cypress are very numerous. Lord Byron says, speaking of the simoon:—

" Beneath whose widely wasting breath
The very cypress droops to death :
Dark tree! still sad when others' grief is fled,
The only constant mourner of the dead."

Sir Walter Scott's ballad in *Rokeby* is well known : —

" Oh, lady ! twine no wreath for me,
Or twine it of the cypress tree.
Too lively glow the lilies light,
The varnish'd holly 's all too bright ;
The mayflower and the eglantine
May shade a brow less sad than mine :
But, lady, weave no wreath for me,
Or weave it of the cypress tree."

Properties and Uses. The wood of the cypress, as we have already seen, was much used by the ancients for all purposes which required durability; and Horace says that whatever they thought worthy of being handed down to the most remote posterity was preserved in the wood of that tree, or of the cedar. It was occasionally used for building; and the bridge thrown by Semiramis over the Euphrates is supposed to have been built of it. The Romans used the wood of the wild, or spreading, cypress, which they called citron wood, for beds and tables; and it was highly esteemed for its numerous spots and figures, from which the tables made of it were called *mensæ tigrinæ et pantherinæ*. It was used in the funeral ceremonies; and, when any one was dead, it was placed at the door, or in the vestibule of the house in which the body lay. Evelyn enumerates many purposes to which the wood of the cypress was applied: — "What the uses of this timber are for chests and other utensils, harps, and divers other musical instruments (it being a sonorous wood, and therefore employed for organ-pipes, as heretofore for supporters of vines, poles, and planks, resisting the worm, moth, and all putrefaction, to eternity), the Venetians sufficiently understood, who did every twentieth year, and oftener (the Romans every thirteenth), make a considerable revenue of it out of Candy (Candia). . . . But there was in Candy a vast wood of these trees, belonging to the republic, by malice or accident, or, perhaps, by solar heat (as were many woods, 74 years after, here in England), set on fire; which, beginning 1400, continued burning 7 years before it could be extinguished; being fed by the unctuous nature of the timber, of which there were to be seen at Venice planks above 4 ft. broad." Evelyn adds that the chips were used to flavour rich wines; that the cones and chips burnt, will destroy and drive away moths, gnats, and flies; and that it yields a gum not much inferior to mastic. The tree is not found of sufficient size, or in sufficient quantities, for the wood to be employed as timber at the present day; but it is said to be still used for building in Candia and Malta; and it is employed as the inner coffin, or shell, for burying the popes, there being also a coffin of lead, and an outer one of pine or fir. Du Hamel says that he had the fence of his melon-ground made with posts of cypress, which, at the time he wrote, had been 25 years in the ground, and were still quite fresh. He recommends trees of 7 in. or 8 in. in diameter for forming palisades for the defence of fortified towns during war, and for other services of a similar kind, where oak of the same dimensions does not last above 7 or 8 years. The young branches of the cypress make, he says, excellent props for vines; and, doubtless, the young shoots in England would make very durable props for supporting plants. In Britain, however, the cypress is only to be regarded as an ornamental tree, and it is one of the most remarkable belonging to that class, the future growth and shape of which may be predicted with tolerable certainty. The planter of an oak, an ash, or an elm, can never tell, till the tree is full grown, whether it will have a widely spreading, or a tall erect, head; but the planter of the spruce or silver fir, or of the Lombardy poplar or evergreen cypress, can predict with certainty that the form will be conical; and he may estimate the size and shape of the cypress, in a given time, with more exactness than he can that of any of the others. Like other trees of narrow conical forms, such as the Lombardy poplar, or even the spruce fir and the larch, the cypress is not calculated to produce a grand effect when planted in masses; but in rows, singly, under certain circum-

stances, in a group of trees of other shapes, or to break an outline formed by round-headed low trees or shrubs, the cypress is particularly suitable. It is also, from its narrow form and erect habit of growth, well adapted for small suburban gardens, and for planting near buildings, with which, by the contrast it affords to their horizontal roofs, it harmonises better than most other trees. It does not, however, thrive so well within the smoke of cities as the Lombardy poplar. In a picturesque point of view, it may be used in Britain for all those purposes to which we have shown, when treating of the Lombardy poplar (see p. 1662.), that that tree may be applied; but with this difference, that, as the cypress is of slower growth than the Lombardy poplar, and does not attain half its height, the description of round or irregular-headed trees, with which it is to be associated or contrasted, must be proportionately small; and thus, instead of elms, sycamores, and, perhaps, round-headed poplars and pines, must be used, thorns, crabs, sorbs, amelanchiers, cotoneasters, yews, hollies, Portugal laurels, ilexes, &c. Thus far as to the picturesque uses of the common cypress; but every one knows that there are certain associations connected with this tree, which are supposed to render it particularly suitable for places of burial. "If the name of the cypress," Bosc observes, "calls up gloomy ideas, it is not because its foliage has a sad hue, as is commonly alleged, but because its pyramidal shape, affording a striking contrast to the general forms of trees, and its head, occupying but a very limited space, and requiring no pruning, have occasioned it, from the earliest times, to be chosen as an object of decoration; and, as tombs and cemeteries were more decorated, in the earlier ages, than gardens, the cypress was frequently planted among them; till, at last, it has become, in the language of the poets, a symbol of the last residence of man. This is so true," he says, "that the appearance of the cypress produces no gloomy ideas in the minds of the inhabitants of the north of Europe, who only see it in the gardens of the living, or in conservatories; or on those who see the tree without knowing its name or having read anything respecting it. Hence," he continues, "it is only in the imaginations of those who are prepossessed with the supposed character of this tree, that it is considered an image of sadness: other persons regard it as a very beautiful object, fit for forming avenues and planting in pleasure-grounds. Singly, and of a large size," Bosc continues, "the cypress has a grand and very imposing appearance. In pots and tubs, it is highly prized both in France and Italy, and is used, along with orange trees, pomegranates, oleanders, &c., for decorating churches, and other public buildings, during great fêtes; for forming gardens of pots on balconies and on house tops, and even for ornamenting private apartments on holidays." In the *Nouveau Du Hamel*, the cypress is considered as recommending itself for being planted among tombs by filial piety, not only from the gloomy aspect of the tree, but on account of its long duration. "Depuis quelques années," the author says, "on reserve un endroit solitaire dans les parcs et les jardins, pour y placer des urnes et des monumens funéraires. Le cyprès doit y occuper la première place: il doit accompagner de son silence lugubre la retraite paisible des morts. Lorsque tous nos amis auront dit un éternel adieu, le cyprès fidèle nous prêtera son ombrage. Les urnes, les cercueils, périront: il se renouvellera, pour annoncer aux races futures qu'une main hospitalière l'a placé auprès de nous: il pourra quelquefois leur rappeler les bienfaiteurs de l'humanité.

"C'est ainsi, Du Hamel, qu'aux jours de l'avenir
 Tes neveux fortunés, plein de ton souvenir,
 Sans aller te pleurer au pied d'un mausolée,
 S'imagineront voir ton ombre consolée
 Errer dans les bosquets, sous les arbres chéris
 Que tes mains ont plantés, que la terre a nourris."

*Épigramme de Colardeau à Du Hamel de Denainvilliers,
 le Frère de Du Hamel.*

Soil, Situation, Propagation, and Culture. Any common garden soil suits the cypress; but it attains its largest size in such soils as are rather dry and deep, and in situations sheltered rather than exposed. It may be propagated either by cuttings or seeds; the former being put in in autumn, and treated like

those of *Thuja*. (See p. 2460.) The cones, which appear to be ripe in autumn, are not perfectly so, but require to hang on the trees till the following March or April. They may then be gathered, and placed in a warm room, or in a box or basket, and set in a dry stove. In a few days, the scales will open, when the cones may be thrashed and the seeds collected: they may be immediately afterwards sown, and treated like those of the *Abiétinæ*. In England, it is common to sow the seeds in flat pans or in boxes; because, as they are somewhat tender when they first come up, they admit of being more readily protected by being carried to a pit. Unlike the seeds of the genus *Thuja*, which commonly lie in the ground a year, those of the cypress come up in three or four weeks. They grow to the height of 3 in. or 4 in. the first season, and may be transplanted into pots, and kept in a pit through the winter. At the end of the second autumn, they may be planted where they are finally to remain; but, if it be thought necessary, they may be kept three or four years in pots; shifting them frequently, or allowing them to remain in the pot unshifted, according as the object may be to produce large plants, or to concentrate the roots in a small ball, so as to occupy less space in sending the trees to a distance. When the cypress is planted where it is finally to remain, and the situation and soil are suitable, it may be said to require no farther attention during the whole of its existence. It always grows erect, so that no care is requisite to train up a leading shoot; and, as its branches occupy little space, it seldom or never requires pruning. The only culture which we have ever seen given to it in England is, replacing some of the side shoots when their points may have been blown out, by a violent storm of wind and rain, so as to protrude beyond the regular head: but this happens only in very old trees, and in exposed situations; as, for example at Croome.

Statistics. At Syon, it is 52 ft. high, diameter of the trunk 1 ft. 3 in., and of the head 8 ft.; at Fulham Palace, 50 years planted, it is 40 ft. high. In Devonshire, at Kenton, 38 years old, it is 60 ft. high, diameter of the trunk 2 ft. In Dorsetshire, at Melbury Park, 44 years planted, it is 44 ft. high. In Surrey, at St. Ann's Hill, it is 35 ft. high, diameter of the trunk 1 ft. In Northumberland, at Heartburn, 80 years planted, it is 35 ft. high. In Suffolk, at Stretton Rectory, it is 63 ft. high, with a trunk 2 ft. in diameter. In France, at Avranches, in the garden of M. Brunel, 26 years planted, it is 30 ft. high. In Italy, at Monza, 150 years old, it is 90 ft. high, the diameter of the trunk 2 ft. 6 in., and of the head 20 ft.

Commercial Statistics. Price of seeds, in London, of both varieties, 6s. per pound; and of plants in pots, 1s. 6d. each.

‡ 2. *C. THYÏDES L.* The Thuja-like Cypress, or White Cedar.

Identification. Willd. Sp. Pl., 4. p. 512; Kalm It., 2. p. 175; Mill. Diet., No. 5; Du Roy Harbk., 2. p. 198; Wagh. Amer., 8. t. 2; Willd. Arb., 92; N. Du Ham., 3. p. 6; Bon Jard., ed. 1837; Laws. Man., p. 391.

Synonymes. *C. nana mariana*, &c., *Pluk. Mant.*, 61., t. 345. f. 1.; *Thuja sphaeroidalis* Rich. *Mém. sur les Conif.*, p. 43; *Cyprus faux Thuja*, Fr.

Engravings. Wagh. Amer., t. 2. f. 4.; *Pluk. Mant.*, t. 345. f. 4.; N. Du Ham. 3. t. 2.; N. Amer. Syl., 3. t. 152.; Wats. Dend. Brit., t. 156.; and our *fig.* 2327.

Spec. Char., &c. Branchlets compressed. Leaves imbricated in 4 rows, ovate tuberculate at the base. (*Willd.*) An evergreen tree; a native of North America. Introduced in 1736; flowering in April and May.

Variety.

‡ *C. t. 2 foliis variegatis* has clusters of the leaves variegated, or blotched, with white. The plant in the Horticultural Society's Garden, after being 6 years planted, is 5 ft. high. It was received from the Dunganstown Nursery in Ireland about 1831.



Description. The white cedar, according to Michaux, is a tree from 70 ft. to 80 ft. high, and rarely more than 3 ft. in diameter, unless, perhaps, in some of the great swamps, which have not been thoroughly explored. When the white cedars grow close together, the trunk is straight, perpendicular, and destitute of branches to the height of 50 ft. or 60 ft. The bark is very thin on young trees; but on older trees it becomes thick, of a reddish colour, and similar to that of an old vine. When cut, a yellow transparent resin exudes from it, of an agreeable odour, but in such small quantities, that only a few ounces could be collected in the course of a summer, from a tree 3 ft. in diameter. The wood is light, soft, fine-grained, and easily worked. When perfectly seasoned, and after it has been some time exposed to the light, it is of a rosy hue. It has a strong aromatic odour, which it preserves as long as it is guarded from humidity; and it resists the alternations of dryness and moisture longer than the wood of any other species of American tree. The concentric circles are always perfectly distinct, even in trunks of considerable size; but their number and compactness prove that many years must elapse before the tree arrives at its full growth. Michaux informs us that he has counted 275 annual layers in a trunk only 1 ft. 9 in. in diameter, and 47 in a plank only 8 in. thick. The tree, in the climate of London, is of slow growth, seldom exceeding the height of 4 ft. or 5 ft. in 10 or 12 years. There is an old shattered specimen at Mill Hill, probably one of the original plants which were raised by Collinson, which, in 1836, was 15 ft. high; and a magnificent tree at Pain's Hill, near the temple of Bacchus, which, in 1837, was 50 ft. high, with a trunk 2 ft. in diameter; the trunk is erect, and the branchlets are pendulous, somewhat in the manner of those of a spruce fir. There is a very handsome tree of about the same dimensions near the Duke of Devonshire's villa at Chiswick, on the property which in the 17th century belonged to Sir Stephen Fox, and which is now occupied by — Lance, Esq., a well known cultivator of Orchidææ. Plants, in the Horticultural Society's Garden, which have been 12 years planted, are only 5 ft. high; and there are some of the same age, but rather higher, in the Hackney arboretum.

Geography, History, &c. In America, the white cedar grows only in wet grounds in the maritime districts of New Jersey, Maryland, and Virginia, where it nearly fills the extensive marshes which lie adjacent to the salt meadows, and are exposed, at high tides, to be overflowed by the sea. In New Jersey, it covers, almost alone, the whole surface of the swamps, of which the tupelo and red maple occupy the skirts. Farther south, it is mingled with the deciduous cypress, by which it is at length entirely supplanted. In Lower Jersey and Maryland, the swamps are accessible only during the driest part of the summer, and when they are frozen during winter. The trees stand so thick in these swamps, that the light can hardly penetrate through the foliage; and, under their gloomy shade, at every step, are found tufts of the dwarf rhododendron, azalea, and andromeda, the luxuriant vegetation of which proves that they delight in dark and humid places. The Dismal Swamp, near Norfolk, in Virginia, is covered with the white cedar and the deciduous cypress; the cedars being in the centre of the swamp, and the cypresses on the margin. The white cedar was introduced into England by Peter Collinson, in 1736; and, though it is not so frequent in collections as the common cypress, it is still to be met with in the principal nurseries. The tree at Pain's Hill, which is in deep sandy loam, shows that, if not common in the climate of London, it is not because it will not thrive there.

Properties and Uses, &c. The wood, on account of its lightness, and its power of resisting alternations of dryness and moisture, is in common use, at Baltimore and Philadelphia, for shingles, which are cut transversely to the concentric circles, and not parallel to them like shingles of the deciduous cypress. They are from 2 ft. to 2 ft. 3 in. long, from 4 in. to 6 in. broad, and 3 lines thick at the larger end. At Baltimore, they are commonly called juniper shingles, and are there preferred to those of the deciduous cypress,

as they are larger, and free from the defect of splitting when nailed upon the rafters. The houses of Philadelphia, Baltimore, and New York are covered with them; and large quantities are exported to the West Indies. The shingles of the white cedar are much more durable and secure from worms than those of the white pine, generally lasting from 30 to 35 years. The wood is also considered well adapted for joinery and for household utensils. In Philadelphia, there is a distinct class of mechanics, called cedar coopers, who make pails, wash-tubs, churns, &c., of the wood of this tree, for both the domestic and the foreign markets. These utensils are held together with hoops made of young cedars stripped of their bark, and split down the middle. In some places, the sides of fishing-boats are covered with white cedar clap-boards, which are preferred to those of the deciduous cypress, as being lighter, more durable, and less liable to split. The wood makes excellent sounding-boards for pianofortes; and casks formed of it are found better than any others for preserving oils. The young wood makes an excellent charcoal for gunpowder; and the smoke of the seasoned wood affords a beautiful lampblack, which weighs less, and is more intensely coloured, than that obtained from any species of pine. When employed as fence-wood, the rails of young trees, either entire, or split down the middle, and deprived of their bark, last from 50 to 60 years. In England, the white cedar is only planted as an ornamental shrub or low tree; in Scotland, it is rather tender; and in the climate of Paris is rare, seldom rising above 5 ft. or 6 ft. high, and requiring protection during winter. In Germany, it is a green-house plant.

Propagation and Culture. Cones are sometimes imported, and the seeds may be sown early in spring, and treated in all respects like those of *Cupressus sempervirens*: it may also be propagated by cuttings; and, in the London nurseries, it is sometimes raised by layers. It would probably attain a much larger size than it generally does in England, if planted in a moist soil, more analogous to that in which it is found in its native habitats; at the same time, as our summers are far from being so warm as those of Maryland and Virginia, it is not likely that it would succeed in swamps in England so well as it does in those countries; because the average of cold and moisture and warmth must necessarily be materially different. In deep sandy soils, as is proved by the tree at Pain's Hill, it not only grows luxuriantly, but ripens its wood, which it would probably not do in Britain, if grown in a swamp. Price of plants, in the London nurseries, 5s. each; at Bollwyller, 1 franc 50 cents; and at New York, 25 cents.

3. *C. LUSITANICA* Tourn. The Cedar of Goa, or Portuguese Cypress.

Identification. Tourn., 587; Willd. Sp. Pl., 4 p. 511; Mill. Dict., No. 3; Du Ham. Arb., 1. p. 198; Lamb. Pin., ed. 2. t. 65; Lawr. Man., p. 391; Lodd. Cat., ed. 1836.
Synonymes. *C. glauca* Brot. Fl. Lus., 1. p. 216; Lam. Encyc., 2. p. 243; *C. pendula* L'Hérit. Stirp. Nov., p. 15; Hort. Kew., 3. p. 373; N. Du Ham., 3. p. 7; Ben Javé., ed. 1837, p. 370; Cedar of Busaco. *C. pendula* Thunb. Lamb. Pin., ed. 2. t. 66, is supposed to be a different plant.
Engravings. L'Hérit. Stirp. Nov., t. 8; Lamb. Pin., t. 65; N. Du Ham., 3. t. 3; our fig. 2323; and the plate of this tree in our last Volume.

Spec. Char., &c. Branches flexuose, spreading; branchlets quadrangular. Leaves imbricated in 4 rows, acute, keeled, glaucous, adpressed. (Lamb. Pin.) A tree; a native of Goa, in the East Indies. Said to have been introduced in 1683.

Description, &c. A branchy tree, attaining, in its native country and in Portugal, the height of 50 ft. and upwards: branchlets scattered, irregular, flexuose, and spreading; branchlets incurved, very numerous; quadrangular when young, thickly covered with leaves; roundish when old. Leaves scale-like, somewhat stem-clasping; broad at the base, attenuated upwards, awl-shaped, remaining on very long; when young, imbricated in 4 rows, glaucous, marked on the back lengthwise with a concave resinous gland; when old, somewhat distant, scarcely imbricated, rigid afterwards, withered and brownish. Male catkins numerous, ovate, obtusely 8-angled, terminal, solitary, yellowish, 2 lines long; scales about 20, convexo-concave, yellow, greenish externally at the apex. Female catkins solitary, surrounded by the

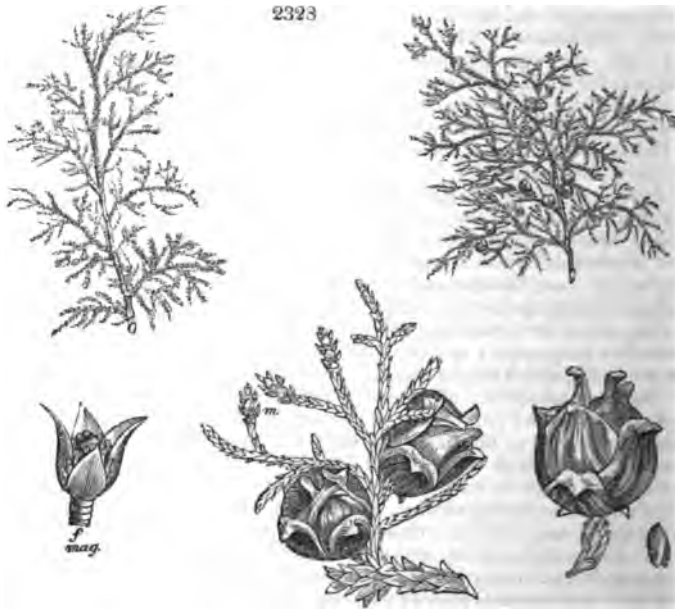

leaves; depressed, minute. Cones ovate-globose, roughish, muricate, about the size of a sloe, covered with a grey powder. Scales 8-angled; mucros elongated, reflexed. Seeds yellowish. (*Lamb.*) This species forms, in the climate of London, a remarkably handsome low tree, with spreading branches, somewhat pendulous, and covered with fine glaucous foliage. It is, however, rather scarce; and almost the only specimens that are to be met with in the neighbourhood of London are in the Horticultural Society's Garden, and at Purser's Cross; at both which places it is upwards of 12 ft. high, after being 12 years planted. The largest specimen which we have heard of is in Ireland, at Oriel Temple, the seat of Lord Viscount Ferrard, the history of which has been given at p. 109., and which was, in 1834, 32 ft. high, after being 24 years planted. There is another fine tree in the nursery of Mr. Hodgins, at Dunganstown, near Wicklow (see p. 116.), which, after being 54 years planted, was 20 ft. high. From Ray's *Letters*, as quoted in the *Hortus Kewensis*, the tree appears to have been introduced into England by Bishop Compton, in 1683; but it still continues rare. Mr. Lambert had a tree in his conservatory at Boyton, which produced "hundreds of cones, when not more than 12 ft. high." In Miller's time, there were specimens of it in different gardens; but most of them were killed by the severe frosts of 1740 and 1762. According to Brotero, it has been long in cultivation in Portugal, where it grows much faster than the common cypress. The tree is abundant at Bussaco, near Coimbra, in Portugal, whence cones might be imported, and thus so fine a tree rendered frequent in collections. Its seeds may be treated like those of the white cedar; or it may be propagated by cuttings, treated like those of *Thuja*. Judging from the two very handsome trees in the Horticultural Society's Garden, and that at Purser's Cross, it grows luxuriantly in a deep loamy soil. In the climate of Edinburgh, it requires protection during winter; and at Paris it is kept in the conservatory. Price of plants, in the London nurseries, 2s. 6d. each.

‡ 4. *C. TORULO'SA* *Lamb.* The *Bhotan*, or twisted, Cypress.

Identification. *Lamb. Pin.*, ed. 2, 2. No. 59; *D. Don* in *Prodromus Nepalensis*, p. 55.; *W. & Webb* in *Litt.*; *Royle* *Illustr.*

Engravings. Our *figs.* 2329 to 2331. of the natural size, from specimens taken from the plant in the Hort. Soc. Garden, and showing the very different appearance that the shoots assume on the same plant, and that even a young one.

Spec. Char., &c. Leaves ovate-obtuse, imbricated in 4 rows. Galbulus globose, pedicellate. Scales bossed. Branchlets round, knotted, divaricate, crowded, spreading. (*Lamb. Pin.*, ii. No. 59.) A tree, a native of Nepal, on the Bhotan Alps. Introduced in 1824; flowering in April.

Description, &c. A beautiful, pyramidal, much-branched, evergreen tree covered with a brown bark. Branches crowded, ascending; branchlets much crowded, round, divaricate, spreading, knotted, 2 in. to 6 in. long, very closely imbricated with leaves. Leaves small, ovate-obtuse, convex, smooth, imbricated in 4 rows, adpressed, green; adult ones persistent, and falling off,



with the bark. Only young male catkins seen: these numerous on the summit of the smaller branchlets, club-shaped, tetragonal, imbricated. Galbulus globose, on a very short scaly pedicel, pitch-black, of a glaucous hue; scales trapezoidal, bossed in the middle, thick, woody. (*Lamb.*) Found by Dr. Royle on the Himalayas, at 11,500 ft. above the level of the sea; also in Kunawar, on the borders of Chinese Tartary. Seeds were sent to England in 1824, and again in 1830, by Dr. Wallich; and there is a plant in the Horticultural Society's Garden, which, 6 years planted, is now 6 ft. high. There are also young plants in the Fulham and several other London nurseries; in the pinetum in the Chester Nursery, and in that at Elvaston Castle. As it appears tolerably hardy, and is very handsome, it well deserves a place in collections.

♀ 5. *C. PENDULA* Thunb. The weeping Cypress.

Identification. Thunb. *Fl. Japon.*, p. 265; Willd. *Sp. Pl.*, 4. p. 512; Staunt. *Embass.*, 2. p. 525. *Lamb. Pin.*, ed. 2, t. 66.

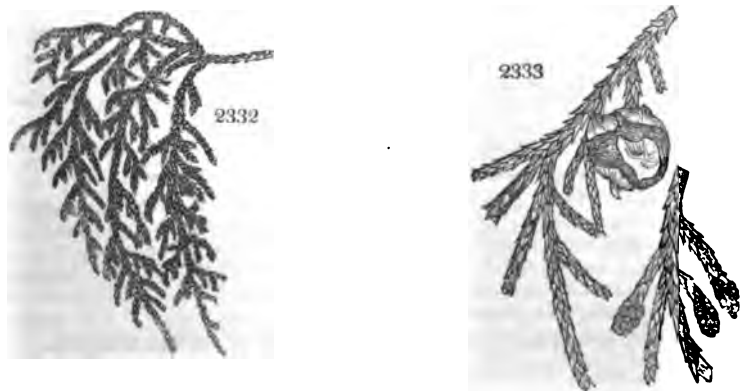

Synonymy. Fl. moro, *Kempf. Amen.*, p. 283.

Engravings. Lamb. Pin., ed. 2, t. 66.; Staunt. Embasa, t. 41.; our *fig.* 2332 to our usual scale; *fig.* 2333. of the natural size; and *fig.* 2334. showing parts of the shoots magnified.

Spec. Char., &c. Branchlets 2-edged, leafy; the oldest very long, pendulous; the younger short, alternate, 2-rowed, spreading. (*Lamb.*) A tree, with a large expanded head. Branches dichotomous, loose, leafless, much divided; branchlets long, compressed, pendulous, closely covered with leaves; again divided, secondary branchlets short, spreading. Leaves imbricated in 4 rows, rather stem-clasping, and triquetrous; keeled, adpressed. Male catkins numerous, ovate, more than one line long, solitary on the apex of the branches, sessile; female depressed, surrounded by spreading leaves, terminating the very short inferior branchlets. Cone brownish, about the size of a sloe. Scales 8-angled; mucros obtuse. Seeds yellowish. (*Lamb.*) A tree, a native of China, said to have been introduced in 1806, but respecting which we know nothing with certainty. The pendulous cypress, or Thuja, at Chelsea, and in the Kew arboretum, may possibly be the same as Thunberg's plant.



App. i. *Kinds of Cuprèssus of which there are Plants in British Gardens, but of which very little is known.*

C. horizontalis Audibert. This plant has been already referred to, p. 2465, as being considered by some to be the same as the spreading variety of *C. sempervirens*; and by others, as a distinct species. As it has produced cones exactly resembling those of *C. sempervirens*, we have no doubt of its being only the spreading variety of that species. The tree in the Horticultural Society's Garden, received from Audibert in 1825, is now 6 ft. high, of vigorous growth, and with spreading branches.

C. expansa Audibert, ? *C. expansa Hort. Par.* The tree received from Audibert's Nursery at Tarascon in 1834, and now in the Horticultural Society's Garden, was, in 1837, 2 ft. high. The *C. expansa* of the *Hort. Par.* is *C. a. horizontalis*.

C. Fothergillii Lec. A plant under this name is in the Horticultural Society's Garden, which was received from the Hammersmith Nursery in 1834. It is now 2 ft. high, and is found rather tender.

C. thurifera. A plant in the Horticultural Society's Garden, bearing this name, is only a few inches high.

C. Tournefortii Audibert. The plant bearing this name in the Horticultural Society's Garden, received from Audibert in 1834, is 2 ft. high.

C. bacciformis Willd. A hardy tree, 20 ft. high. Introduced in 1818.

C. australis Pers. A shrub, with slender branches, a native of New Holland, and rather tender. Before anything can be determined with certainty respecting the above kinds, they must have produced fruit; and, consequently, several years must elapse. Most of them are probably only synonyms to species of *Cuprèssus* above described, or of some of the kinds of *Juniperus* which will hereafter be given.

App. ii. *Kinds of Cuprèssus not yet introduced.*

C. nootkatensis Lamb. Branchlets tetragonal. Leaves broad-ovate, acute, convex on the back, imbricated in 4 rows, adpressed. Galbulus globose, almost sessile. Scales bossed, smooth, (*Lamb. Pin.*, ii. No. 60.) A tree. Branches round, spreading, scaly from the withered leaves, covered with a brownish bark. Branches numerous, somewhat distant, tetragonal, short, spreading. Leaves broad-ovate, acute, very thick, glabrous, shining, closely adpressed, imbricated in 4 rows, convex on the back; adult ones shortly awl-shaped at the apex. Galbulus globose, lateral, the size of a wild cherry, covered with a glaucous hue, on a very short scaly footstalk, similar to a branchlet; scales trapezoidal, peltate, smooth, bossed in the centre. (*Lamb.*) Discovered by Mr. Menzies, in Nootka Sound, on the north-west coast of North America.

C. Japonica Thunb. *Jap.*, p. 265. Willd. *Sp. Pl.*, 4. p. 513. *Lin. Supp.*, p. 421. Leaves 4-rowed, compressed, furrowed, decurrent. (*Thunb.*)

GENUS XII.



TAXODIUM Rich. THE TAXODIUM, or DECIDUOUS CYPRESS. *Lin. Syst.* Monœcia Monadèlphia.

Identification. Rich. *Conf.*, p. 148.; Lamb. *Pin.*, ed. 2, 2.

Synonymy. *Cuprèssus L.* *Schubertia* Mirb., *Condylocarpus Salisb.*

Derivation. From *taxis*, the yew, and *oidos*, like; the trees resembling the yew.

Description. Lofty, deciduous, and evergreen trees, natives of the southern part of North America; separated from the genus *Cuprèssus*, principally because the male catkins are disposed in loose spreading bunches, instead of being solitary and terminal; and because the female catkins are roundish and scaly, like the male, and each scale has only 2 perfect flowers. The genus is also distinguished by the embryo having from 5 to 9 cotyledons. The species are generally propagated by seeds, and the varieties by cuttings or layers.

‡ 1. *T. DISTICHUM* Rich. The two-ranked-leaved Taxodium, or Deciduous Cypress.

Identification. Rich. in Ann. Mus., xvi. p. 298; Mém. sur les Conif., p. 53. 143; Lamb. Pin. ed. 2., 2. t. 63.

Synonymes. Cupressus disticha Lin. Sp. Pl., 1422; Hort. Cliff., p. 498; Gron. Virg., p. 153; Michx. Fl. Bor. Amer., 2. p. 308.; Arb., 3. p. 4.; N. Amer. Syl., 3. p. 197.; Pursh Fl. Amer. Sept., 2. p. 645; Lodd. Cat., ed. 1836; C. americana Cat. Carol., 1. p. 11.; C. virginiana Comm. Hort., 1. p. 113; Pluk. Alm., p. 125; Schubertus disticha Mirb., Lous. Man., p. 392; bald Cypress, Cypress, Amer.; Cyprés de l'Amérique, Cyprés chauve, Fr.; zweysellige Cypressse Ger. *Engraving.* Rich. Conif., t. 10.; Michx. Arb., 3. t. 1.; North Amer. Syl., 3.; Catesb. Car., t. 11.; Comm. Hort., 1. t. 59.; Pluk. Alm., t. 85. f. 6.; Lamb. Pin., ed. 2., t. 63.; our fig. 2335; and the plates of this tree in our last Volume.

Spec. Char., &c. Leaves 2-rowed, flat, deciduous. Male flowers leafless and paniced. Cones somewhat globose. (Willd.) A lofty deciduous tree; a native of North America. Introduced before 1640.



Varieties.

- ‡ *T. d. 1 patens* Ait. Hort. Kew., ed. 2., v. p. 323. — Leaves approximate, and strictly 2-rowed. This is the most common form.
- ‡ *T. d. 2 nutans*, l. c.; *T. d. pendula* Loud. Hort. Brit.; the long-leaved deciduous Cypress; has the leaves much longer and drooping, but more remote and thinner. There is a tree of this variety in Loddiges's arboretum, of which figs. 2336. and 2337. are portraits; fig. 2336. being taken when the fronds or deciduous shoots are first



developed in June, when they have the tortuous curly appearance shown in the figure; and *fig. 2337.* showing the fronds fully expanded, as they appear in August. A specimen of the early shoots is shown more in detail in *fig. 2338.* There is a tree of this variety at Hendon Rectory, which, in 1837, was 15 ft. high. There are also fine specimens at Messrs. Loddiges's, in the Horticultural Society's Garden, and more especially at White Knights.

- † *T. d. 3 excelsum* Booth.—There is a plant of this variety in the Horticultural Society's Garden, which, in 1837, when 2 years old, was 2 ft. high.
- † *T. d. 4 sinense*, *T. sinense Noisette.*—There is a tree in the Horticultural Society's Garden, which was received under this name from M. Noisette, and which, in 1837, was 6 ft. high, after having been planted 10 years. How far it differs from *T. d. nutans*, or whether it differs at all, we are uncertain.
- † *T. d. 5 s. pendulum*, *T. sinense pendulum Hort.*—There is a tree under this name in the Horticultural Society's Garden, which was received from Mr. Knight in 1827, and which in 1837 was 6 ft. high.

Remarks. The deciduous cypress is one of those trees that sport exceedingly in the seed-bed; and, hence, wherever a number of them are found growing together, scarcely any two appear to have precisely the same habit. This is strikingly the case at White Knights, where there are several scores of trees, presenting a variety of forms and foliage almost as great as their number. They may all, however, as well as those enumerated in the above list, be reduced to the following four forms. 1. The species, having the branches horizontal or somewhat inclined upwards. 2. *T. d. pendulum*, with the branches pendulous. 3. *T. d. nutans*, with the branches horizontal, and the young shoots of the year pendulous; the leaves being twisted and compressed round them in the early part of the season, but fully expanded, like those of the species.

towards the autumn. Most of these shoots have their points killed every winter, and many of them are entirely destroyed. 4. *T. d. tortuosum pendulum*, with the leaves on the young shoots tortuous, and the branches pendulous. There is a very elegant specimen of this tree at White Knights. With respect to the *T. sinense* of cultivators, we have not been able to discover in what it differs from *T. nutans*.

Description. A tree, in North America, 120 ft. high. Trunk very thick, often from 25 ft. to 40 ft. in circumference at the base. Branchlets very slender, elegantly pinnate, bark brownish. Leaves pectinate and distichous; spreading horizontally, from being twisted at the base; linear, mucronulate, flat, 1-nerved (nerve somewhat depressed above); glabrous on both sides, light green; margins acute, exterior somewhat convex, $\frac{1}{2}$ in. or more in length, about 1 line broad. Male catkins roundish, in a racemose panicle; scales very short, obtuse, concave, keeled, membranaceous on the margin. *Galbulus* roundish or roundish-oval, of the size of a pigeon's egg. The tree, though pyramidal in form when it is young, yet, when full-grown, has a spreading broad head, somewhat in the manner of that of an old cedar of Lebanon. There are but few trees in Britain which have assumed this character; but, according to Michaux, it is common in the swamps of America; and it has also begun to show itself in some of the old trees at Whitton and Syon. The bark of trees which grow near the natural beds of the rivers, and are half the year surrounded with water to the height of 3 ft. or 4 ft., is lighter-coloured than that of trees which stand in places which the waters do not reach; the wood, also, is whiter, less resinous, and less heavy. These are called white cypresses. The others, of which the bark is browner, and the wood heavier, more resinous, and of a dusky hue, are called black cypresses; whence we have, in some catalogues, *T. d. nigrum*; but this name we have not given in our list of varieties, as it is obviously only that of a variation. The wood is fine-grained, and, after being for some time exposed to the light, becomes of a reddish colour: it possesses great strength and elasticity, and is lighter and less resinous than that of the pines. It has also a greater power of resisting heat and moisture. The foliage is open, light, and of a fresh agreeable tint; each frond, or young shoot, is 4 in. or 5 in. long, and consists of two parallel rows of leaves upon a common stem. The leaves are small, fine, and somewhat arched, with the convex side outwards. In the autumn, they change from a light green to a dull red, and soon after fall off. The deciduous cypress blossoms in Carolina about the 1st of February. The male catkins are produced in flexible pendulous aments, and the female in very small bunches. The cones are about as large as the point of the thumb, hard, roundish, and of an uneven surface. The seeds are small, ligneous, and of irregular shapes, with a cylindrical kernel: they are ripe in October, and retain their productive power two years. (*Lamb., Michx., and obs.*)

The deciduous cypress, in America, attains its largest size in the swamps of the southern states and the Floridas, on the deep miry soil of which a new layer is every year deposited by the floods. These trees, which are sometimes 40 ft. in circumference at the base, are, however, always at least three times as thick there as they are in any other part of the trunk. The base is usually hollow for three quarters of its bulk; and its surface is longitudinally furrowed with deep tortuous channels. In consequence of the hollowness and comparative worthlessness of the lower part of the trunk, the negroes raise themselves on scaffolds 5 ft. or 6 ft. from the ground, when the trees are to be felled, in order to cut off only the sound part of the tree. The roots of large trees, particularly in situations subject to inundation, are charged with conical protuberances, commonly from 1 ft. 6 in. to 2 ft. high, and sometimes from 4 ft. to 5 ft. in thickness: they are always hollow, smooth on the surface, and covered with a reddish bark, like the roots, which they resemble also in the softness of their wood. Michaux says that "no cause can be assigned for their existence: they are peculiar to the deciduous cypress, and begin to appear when it is only 20 ft. or 25 ft. high. They are made use of by the negroes for bee-hives." He adds that they exhibit

no signs of vegetation, and that he has never succeeded in obtaining shoots from them by wounding the surface, and covering them with earth. These facts are confirmed by Dupratz, the author of *Voyage à la Louisiane*, who says that he has seen protuberances which had grown up from the roots of deciduous cypresses after they had been cut down, in the form of a sugar-loaf, to the height of 10 ft., being a fourth part as broad as they were high, and without having ever produced either a root or a shoot. Bosc, who mentions this on Dupratz's authority, doubts the accuracy of his observation, and says that he never saw these protuberances of more than 1 ft. in height. Flint, in his *Geography and History of the Western States*, mentions these "curiously-shaped knobs," which, he says, are, in America, commonly called "cypress knees;" while the hollow base of the trunk is called "the tree's buttock." "The cypress," he says, "loves the deepest, most gloomy, inaccessible, and inundated swamps; and seems to flourish where water covers its roots more than half the year. When the water rises from 8 ft. to 10 ft. from the overflow of the rivers, the apex of the tree's buttock is just on a level with the surface of the water. It is then, in many places, that they cut it. The negroes surround the tree in periogues, and thus get at the tree above the large and broad buttock, and fell it with comparative ease. They cut off the straight shaft as suits their purpose, and float it to a raft, or the nearest high grounds." (*Geog. and Hist., &c.*, vol. i. p. 62.) The knees are produced abundantly by the large trees at Syon and Whitton, where they rise upwards of 1 ft. above the surface of the soil; and more than double that height from the roots under water, in the case of trees growing by the sides of lakes at these places. These protuberances are shown in the plate of the full-grown tree of this species in our last Volume. The tree is of comparatively slow growth in the climate of London; and the fronds, or points of the shoots, are frequently killed back by early frosts. Nevertheless, it attains the height, in moist soils, of 5 ft. or 6 ft. in 6 or 8 years, and of 15 ft. in 12 or 15 years; and, in 40 or 50 years, it is 40 ft. or 50 ft. in height. The largest tree in the environs of London is at Whitton, where, in 1834, it was 81 ft. high, with a trunk 5 ft. in diameter at 2 ft. from the ground. There are trees nearly 70 ft. high at Syon; and trees at Bagshot, St. Ann's Hill, and Purser's Cross which have borne male blossoms and cones. The first tree on record which bore cones in England was one at Wimbledon, before 1752. (See *History*.) The tree thrives well in Scotland, and also in the climate of Paris, and in central Germany.

Geography. The deciduous cypress is found on the banks of the Indian River, a small stream that waters part of Delaware, in lat. $38^{\circ} 50'$, and which may be considered as its northern boundary. Hence, proceeding southward, it becomes more abundant in the swamps; but, in Maryland and Virginia, it is confined to the view of the sea, where the winter is milder, and the summer more intense. Beyond Norfolk, its limits coincide exactly with those of the pine barrens; and, in the Carolinas and Georgia, it occupies a great part of the swamps, which border the rivers after they have left the mountains, and entered the low lands. In East Florida, the soil is, in general, more uniform; and here the long-leaved pine (*P. australis*) and deciduous cypress are very abundant; the one on the low grounds, and the other on the uplands. The Mississippi, from its mouth to the river of the Arkansas, a distance (following its windings) of more than 600 miles, is bordered with marshes, which, at the annual overflowing of this mighty stream, form a vast expanse of waters. In Louisiana, those parts of the marshes where the deciduous cypress grows almost alone are called *cyprières* or cypress swamps, as those in which it is mingled with the white cedar are called cedar swamps, and they sometimes occupy thousands of acres. In the Floridas, these swamps are contiguous to the immeasurable tracts covered with pines, and called pine barrens; or with tall rank grass, and called savannahs. In the midst of the pine forests and savannahs is seen, here and there, a bog, or a plash of water, filled with deciduous cypresses, the squalid appearance of

which, when they exceed 18 ft. or 20 ft. in height, proves how much they are affected by the barrenness of the soil. From these particulars an idea may be formed of the situations and soils in which the deciduous cypresses are found, over an extent of more than 1500 miles, from their first appearance in the north, to the Mississippi. Michaux adds that he has some reason to believe that the deciduous cypress is found as far south as the mouth of the Rio del Norte, lat. 36°; which, if we measure the circuit of the Gulf of Mexico, makes a range for this tree of more than 3000 miles. (*Michx.*)

History. The deciduous cypress appears to have been introduced before 1640; as Parkinson, writing in that year, speaks of it. "The Americane cypresse is, as it is said, in sundrie countries of the North America; its seed was brought by Master Tradescant from Virginia, and sown here, and does spring very bravely." (*Park. Theat., &c.*, p. 1477.) Miller, speaking of this tree, says: "One in the gardens of John Tradescant, in South Lambeth, near Vauxhall, is upwards of 30 ft. high, and of considerable bulk; and, though in a common yard at present, where no care is taken of it, but, on the contrary, many hooks are driven into the trunk to fasten cords thereto for drying clothes, yet the tree is in great health and vigour, but has not produced any fruit as yet, which may be occasioned for want of moisture; for we often see aquatic plants will grow upon a drier soil, but yet are seldom so productive of either flowers or fruit as those which remain growing in the water." (*Dict.*, ed. 1731.) In a subsequent edition, Miller says: "There is also a pretty large tree of this kind now growing in the gardens of Sir Abraham Jansen, Bart., at Wimbledon, in Surrey, which has produced a great quantity of cones for some years past, which, in favourable seasons, come to maturity; and the seeds have been as good as those which have been brought from America. This tree was transplanted when it was very large, which has stunted its growth," and may have thrown it into fruit. (See *Dict.*, ed. 1752.)

The deciduous cypress appears to have been introduced into Scotland about 1746; as Dr. Walker, in 1776, speaks of a fine tree of it in the grounds at Loudon Castle, in Ayrshire, which, he says, was then 30 years old, and 25 ft. high. This tree, he adds, was "the only considerable tree of the kind in North Britain. It was feathered down to the ground with branches; and is, without exception, the most elegant tree of the kind to be seen in our climate. It used formerly to be kept in the green-house, which, from this instance, appears quite unnecessary, as the tree has never suffered in winter. It stood well sheltered, and in a heavy clay soil." (*Essays, &c.*, p. 80.) Humboldt mentions that there are some trees in Mexico, which were planted in the garden of the emperor there, before the Spanish invasion; and it is probably to these that Ward alludes in his *Mexico*. "The cypress of Montezuma," he says, "stands in the gardens of Chapultepec, near Mexico; and, as it had attained its full growth when that monarch was on the throne (1520), it must now be nearly 400 years old. The trunk is 41 ft. in circumference, and is so high as to appear slender." At Santa Maria de Tula, in Oaxaca, is a cypress 93½ ft. in circumference.

Botanical History. Parkinson, in 1640, expresses his doubts that this tree was not "a true cypresse," and suggests that it must have been called so from the fragrance of the wood. It was, however, classed by Linnæus, and all succeeding botanists, as a *Cupressus*, till M. Richard, in the *Annales du Musée*, tom. xvi. p. 269., constituted it a genus, under the name of *Taxodium*; which name was applied from the leaves being disposed in the same manner as those of the yew. Two years afterwards, M. Mirbel and M. Schubert described it as a separate genus, under the name of *Schubertia* (*Nov. Bull. de la Soc. Phil.*, iii. p. 123.); but the name of *Taxodium* having been applied first, and accompanied by a scientific description, necessarily takes precedence.

Properties and Uses. The wood is universally employed, throughout the United States, for the best kind of shingles; and in Louisiana it is used for almost every other purpose to which timber is applied. Nearly all the

houses in New Orleans, in 1819," Michaux informs us, were of wood, and not only the frame, but the interior work and the outer covering, were, in most cases, of cypress. The shingles made of this wood are split off parallel to the concentric circles. At Norfolk, in Virginia, near the Dismal Swamp, immense quantities of shingles are made both of this wood and of that of the white cedar. Throughout the southern states, it is used for the interior fitting up of brick houses, for window sashes, and panels of doors exposed to the weather; and cabinet-makers use it for the drawers, &c., of mahogany furniture. It has been employed, in Louisiana, for the masts and sides of vessels; and is often used for canoes, which, when fashioned from a single trunk, and about 30 ft. long and 5 ft. wide, are light, solid, and more durable than those formed of any other tree. It makes excellent and very durable posts for fences, and

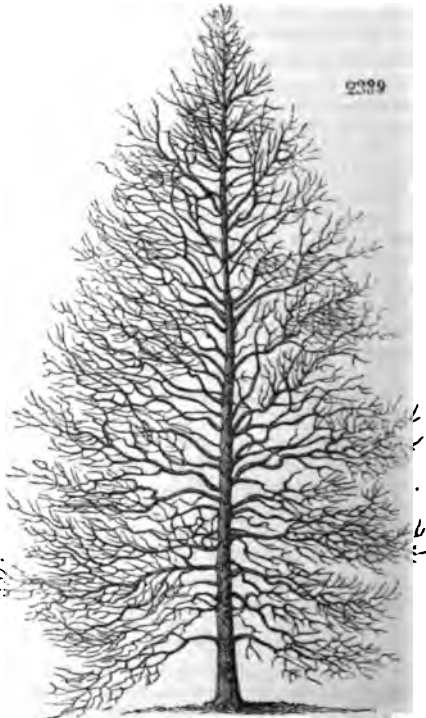

pipes to convey water under ground; particularly the kind grown on dry land, and called the black cypress, the wood of which is more resinous and solid than that of the white. A resin, of an agreeable odour and red colour, exudes from the bark; but not in sufficient abundance to be used for the purposes of commerce, though more copious than that of the white cedar: the negroes prefer it to that of the pines for dressing wounds. The protuberances formed by the roots, as already observed, are used by the negroes as bee-hives. In England, the deciduous cypress is only valued as an ornamental tree; and the delicacy of its foliage, and the graceful pendent disposition of its lower branches, insure it a place in every collection where the soil is naturally moist, or where it can be planted in the vicinity of water. The noble trees at Syon and Whitton are admired by all who have seen them. The most graceful pendent-branched tree which we have seen is that at St. Ann's Hill, already mentioned; and, in the wood at White Knights, there are above a score of young trees, so different in their foliage, in the fastigate, spreading, or pendulous disposition of their branches, and also in the twisted or flattened 2-ranked arrangement of the leaves, that each might be considered as a distinct variety.

Soil, Propagation, &c. A rich moist soil is required to produce the deciduous cypress of any size, and it will not thrive in elevated situations. The species is increased by seeds, which are procured from imported cones: they may be treated in all respects like those of the common evergreen cypress, and, like them, come up the first year. The tree may also be propagated by cuttings, put in in autumn, in sand or heath soil, in the shade, and kept moist; a practice which, Bosc observes, is in use in the nurseries at Orleans, but not in those at Paris. Cuttings of the winter's wood, or of the summer's shoots with the leaves on, will root in a vessel of water in a very few

weeks; and, if an inch of soil be placed at the bottom of the vessel, the fibres will root into it, and the plants may be used as if they had been struck in the usual manner. Layers, put down in moist soil, root the first year.

Statistics. In the Neighbourhood of London. At Whitton, it is 81 ft. high, diameter of the trunk 5 ft. at 2 ft. from the ground; at Purser's Cross, it is between 70 ft. and 80 ft. high (this tree has borne cones and male blossoms); at Abercorn Priory, at Stanmore, it is 42 ft. high, diameter of the head 75 ft.; at Muswell Hill, it is 43 ft. high; at Kenwood, 50 years planted, it is 40 ft. high, diameter of the trunk 2 ft. 8 in., and of the head 24 ft.; at Gunnersbury Park it is 51 ft. high, diameter of the trunk 1 ft. 6 in.; at York House, Twickenham, it is 52 ft. high, diameter of the trunk 3 ft., and of the head 33 ft.; and at Syon there are several from 60 ft. to 70 ft. high, and, among others, the tree of which we have given a portrait in our last Volume. — South of London. In Cornwall, at Port Elliot, 80 years planted, it is 50 ft. high, diameter of the trunk 3 ft., and of the head 30 ft. In Hampshire, at Strathfieldaye, it is 50 ft. high, with a trunk 3 ft. 4 in. in diameter. In Surrey, at St. Ann's Hill, 35 years planted, it is 45 ft. high, diameter of the trunk 2 ft., and of the head 30 ft., bearing cones abundantly. — North of London. In Berkshire, at Ditton Park, 90 years old, it is 80 ft. high, with a trunk 3 ft. 6 in. in diameter. In Cambridgeshire, at Wimpole, 45 years planted, it is only 27 ft. high. In Essex, at Hylands, 10 years planted, it is 13 ft. high. In Herefordshire, at Hisfield, 11 years planted, it is 14 ft. high. In Leicestershire, at Elvaston Castle, 16 years planted, it is 15 ft. high. In Suffolk, at Great Livermore, 35 years planted, it is 37 ft. high, the diameter of the trunk 1 ft. 2 in., and of the head 18 ft. In Warwickshire, at Combe Abbey, it is 47 ft. high, the diameter of the trunk 2 ft. 3 in., and of the head 24 ft. In Worcestershire, at Croome, 60 years planted, it is 55 ft. high, the diameter of the trunk 2 ft., and of the head 40 ft. In Yorkshire, at Studley, the very handsome tree of which *Ag.* 2339. is a portrait, 36 ft. high. — In Scotland, in Ayrshire, at Fullarton, 50 years planted, it is 20 ft. high. — In Ireland, in the county of Down, at Ballylead, 22 years planted, it is 16 ft. high. — In France. In the Botanic Garden at Toulon, 38 years planted, it is 80 ft. high, the circumference of the trunk 10 ft. 4 in. On the Government Farm of Rambouillet are several from 65 ft. to 70 ft. high, with trunks about 10 ft. in circumference; and several others with trunks from 3 ft. to 8 ft. in circumference. At Avranches, in the Botanic Garden, 20 years old, it is from 30 ft. to 40 ft. high, the diameter of the trunk 1 ft. 2 in., and of the head 24 ft. In Austria, near Vienna, at Brück on the Leytha, 30 years planted, it is 36 ft. high, the diameter of the trunk 1 ft. 6 in., and of the head 13 ft. — In Prussia, at Berlin, at Sans Souci, from 45 to 50 years old, it is 20 ft. high, the diameter of the trunk 1 ft., and of the head 9 ft. — In Italy, in Lombardy, at Monza, 24 years planted, it is 62 ft. high, the circumference of the trunk 4 ft. 2 in., and the diameter of the head 45 ft. — In America, at Philadelphia, in Bartram's Botanic Garden, it is 120 ft. high, with a trunk 28½ ft. in circumference, above the buttock.

Commercial Statistics. Price of cones, in London, 3s. per quart; plants 1s. each: at Bollwyller, plants are from 1 franc to 2 francs; and at New York, 50 cents.

♀ *T. sempervirens* Lamb. Pin., ed. 2., 2. t. 64.; our *Ag.* 2340. to our usual scale; and *Ag.* 2341. of the natural size. The evergreen Taxodium. Leaves distichous, linear, acute, evergreen, coriaceous, glabrous, opaque. (*Lamb.*) An evergreen tree. Branchlets angled, leafy, glabrous. Leaves linear, acute, distichous, coriaceous, glabrous: opaque and shining on both sides, keeled beneath, flat on the margin; ½ in. to 1 in. long; ½ line broad, decurrent. Galbulus terminal, solitary, roundish, with short imbricated scales at the base; scales trapezoidal, peltate, thick, fungous and woody; rough above, and radiately striated; depressed in the centre, terminating at the base in a thick angular pedicel. Seeds many to a single scale, angular, yellowish. (*Lamb. Pin.*) This species was discovered by Mr. Menzies, on the north-west coast of America, in 1796; and immense trees of it were seen by Dr. Coulter in 1836; but it has not yet been introduced. It will probably prove hardy; and, in that case its introduction would be exceedingly desirable.

♀ *T. capensis*; Cupressus juniperoides *Lin. Sp. Pl.*, 4.; the African, or Cape, Cypress; has the branches loose and spreading; leaves nearly 1 in. long, of a light green colour, and continuing the same all the year. Galbulus black when ripe. A native of the Cape of Good Hope; cultivated before 1756 by Miller; and flowering in April and May. It requires the protection of the greenhouse.



GENUS XIII.



JUNIPERUS L. THE JUNIPER. *Lin. Syst. Diœ'cia* Monadélphia.

Identification. *Lin. Gen.*, No. 1134.; *Reich.*, 1240.; *Schreb.*, 1552.; *Gœrtn.*, t. 91.; *Tourn.*, t. 361. *Jus.*, 413.; *Lamb. Pin.*, 2.

Synonymes. *Sabina Bauh.*; *Cedrus Tourn.*; *Genévrier, Fr.*; *Wachholder, Ger.*

Derivation. From *Junepirus*, rough or rude, *Celt.*, the plants of this genus being stiff shrubs; or from *Juniores pariens*, from the young and old leaves being on the tree at the same time, or with reference to the young fruit being produced before the old fruit drops off.

Description, Geography, &c. Evergreen shrubs and trees; natives of Europe, Asia, Africa, and America; mostly hardy in British gardens. The wood of all the species is more or less aromatic, and very durable. The berries are employed in medicine as a diuretic, and are used in flavouring gin; but in some species the aromatic is united with an acrid principle, as in the savin. According to Royle, the berries of the common juniper secrete sugar, as well as an essential oil. The genus has a very extensive geographical range. The common juniper is found in most parts of Europe and North America; and it was also seen by Capt. Webb on the Neetee Pass, in the Himalayas, where it is called Bilhara, also Pudma, and Pumaroa; and by Mr. Inglis, in Kunawar. Here there is also another species, *J. religiosa* Royle (? *J. recurva* Ham.), called Gogul by the natives, and employed for burning as incense in their religious ceremonies. The most common species, however, in India, is *J. squamata* Royle (*J. squamata* D. Don), occurring on such mountains as Choor and Kedarkauta, as high as 11,000 ft.; as well as near Neetee, &c.; and on Peer Punjal, as well as Gossainthan. In the last-mentioned place, *J. recurva* is also found. As there is some difficulty in distinguishing the species, it is not easy to ascertain what species is called bastard, or creeping cedar, in contradistinction to the Himalaya cedar wood (*Juniperus excelsa*), found in Gossainthan, in Kamaon, and on the confines of Tartary. This, in its foliage, resembles *Cupressus torulosa*, specimens of which, indeed, are mixed with those of *J. excelsa* in the East Indian herbarium. The former appears to be the plant called Theloo by the natives, and seen by Huree Sing between Simla and Phagoo, near a small piece of water; and by Murdan Aly, a very intelligent plant collector, near Saughee Ke Ghat, a high hill to the southward of Rol. It is also found in Kamaon, near Neetee, Simla, and in Kunawar. (Royle *Ill.*) The species, with the exception of three or four, which have grown to some size, and ripened fruit in England, are very imperfectly known to British cultivators; and, probably, some of those kinds which we have given as distinct species may prove not to be so. We could not, however, avoid this, from the impossibility of seeing any plants of many of the kinds, but those which were quite young. All the species are readily propagated by seeds, which retain their vitality, when kept in the berry, for several years; and, when sown, lie one year, and often two years, before they come up. They may also be increased by cuttings, planted in sandy soil, in a shady situation, in the autumn, and covered with a hand-glass during winter; or by layers.

Insects. The juniper is not much frequented by insects. Two species of British lepidopterous insects, however, derive their names from feeding upon this tree; namely, *Thera juniperata*, a very rare species of *Geometridæ* (*Steph. Illust.*, pl. 31. f. 2.); and *Anacampsis Juniperella* (one of the *Tinidæ*). Three species of Linnæan Hemiptera, also, are named from their inhabiting this plant; namely, *Pentatoma juniperina* (one of the field bugs), *Aphis juniperi* (a species of plant louse), and *Thrips juniperi*; as well as a saw-fly (*Tenthredo juniperi*).—*J. O. W.*

The Fungi are not very numerous. On the leaves of *Juniperus communis* are found *Hystèrium Pinastri* var. *Juniperi* Fr., *Hystèrium Juniperi* Grev., t. 26., and our fig. 2342; and *Podisoma folisolum* Berk. On the living branches are found *Gymnosporangium Juniperi* Lk., and *Podisoma Juniperi communis* Fr., which are a kind of perennial mildew, resembling in structure *Pucciniæ*, with the addition of copious gelatine. On *Juniperus Sabina* occurs *Podisoma Juniperi Sabinae*.—*M. J. B.*



§ i. *Oxycedri*.—Leaves spreading in the adult plants. D. Don.

■ 1. *J. COMMUNIS L.* The common Juniper.

Identification. Lin. Sp. Pl., 1470.; Willd., 4. p. 853.; Fl. Br., 1085.; Eng. Bot., t. 1100.; Hook. Scot., 290.; Woodv., t. 95.; Mill. Illust., t. 95.; Ehr. Pl. Off., 449.; Engl. Flor., 4. p. 251.; N. Du Ham., 6. p. 46.; Hook. Brit. Fl., p. 434.; Lindl. Syn., p. 241.; Lodd. Cat., ed. 1836; Bon Jard., ed. 1857.

Synonymes. J. No. 1661a., *Hall. Hist.*, 2. p. 319.; *J. vulgaris*, &c., *Raii Syn.*, 444., *Bauh. Hist.*, 1. pt. 2. p. 293., *Bauh. Pin.*, 488., *Ger. Em.*, 1572., *Matth. Valgr.*, 1. p. 109., *Com. Epit.*, p. 53., *Lob. Ic.*, 2. p. 222.; *J. minor Fuchs Hist.*, p. 78., *Ic.*, t. 44., *Dalech. Hist.*, p. 67.; *J. communis saxatilis Pall. Ross.*, 2. p. 12.; *J. alpina Gus. Hist.*, 38., *J. Bauh.*, 1. lib. 9. p. 329.; *J. minor montana C. Bauh. Pin.*; *Genévrier commun, Fr.*; gemeiner Wachholder, *Ger.*

Engraving. Engl. Bot., t. 1100.; Woodv., t. 95.; Mill. Illust., t. 95.; N. Du Ham., t. 15. f. 1.; Hayne Abbild., t. 206.; our *fig.* 2349. to our usual scale; and *fig.* 2348. of the natural size.

Spec. Char., &c. Leaves in threes, spreading, mucronate. Berries longish. (*Willd.*) An evergreen shrub; a native of Europe, North America, and Asia; flowering in May.

Varieties.

■ *J. c. 1 vulgaris* Park. Theat., 1029., Mart. Mill., No. 7.; *J. v. fruticosa Bauh. Pin.*, p. 488.; *J. c. erectis Pursh Fl. Amer. Sept.*, ii. p. 646. — Leaves, according to Hayne, $\frac{1}{2}$ in. in length. A bushy shrub, from 3 ft. to 5 ft. high; but, in favourable situations, growing much higher. (*Willd.*)

■ *J. c. 2 suecica* Mart. Mill., Ait. Hort. Kew., ed. 2., v. p. 414.; *J. suecica Mill. Dict.*, No. 2.; *J. vulgaris arbor Bauh.*; the Swedish, or true, Juniper; (*fig.* 2343.) has the leaves spreading and acute, and according to Hayne, 1 in. in length; and the branches erect, with oblong fruit. This kind was supposed by Miller to be a species, because he found it always come true from seed. It generally attains the height of 10 ft. or 12 ft., and sometimes of 16 ft. or 18 ft. The branches are more erect than those of the common juniper; the leaves are narrower, they end in more acute points, and are placed farther asunder on the branches; the berries are also larger and longer. It is a native of Sweden, Denmark, and Norway, and is in common cultivation in British nurseries. The leaves of the plants in the Horticultural Society's Garden, which are marked *J. suecica*, and also those of the plants that are sold for that variety, or species in the British nurseries, are rather shorter than those of the common juniper; or, at all events, not longer. Perhaps the variety *J. c. oblonga*, mentioned below, which has leaves an inch long, and the fruit oblong, may be the true Swedish Juniper.



■ *J. c. 3 nana* Willd. Sp. Pl., iv. p. 854.; *J. communis β Fl. Br.*, 1086., *Lightf.*, p. 624., *Lin. Sp. Pl.*, 1470.; *J. c. saxatilis Pall. Ross.*, ii. t. 54.; *J. No. 1661. Hall. Hist.*, ii. p. 320.; *J. alpina Ray Syn.*, 444., *Bauh. Hist.*, i. pt. 2. p. 301. f. 302., *Clus. Hist.*, p. 38., *Pann.*, p. 26. f. 25., *Lodd. Cat.*, ed. 1836; *J. alpina minor Ger. Emac.*, 1372.; *J. minor montana, &c., Bauh. Pin.*, 489., *N. Du Ham.*, vi. p. 46.; *J. nana Smith Engl. Fl.*, iv. p. 252.; *J. sibirica Hort.*; *J. däärica, Hort.*; *J. c. montana Ait. Hort. Kew.*, v. p. 415.; and our *fig.* 2344.; has the leaves broader and thicker, and the fruit longer, than the species.



■ *J. c. 4 oblonga, J. oblonga Hort.*, (*fig.* 2346.) has longer leaves than any other variety, and small oblong fruit. There is a large bush of this variety in the Horticultural Society's

Garden, which is only 4 ft. high, after having been planted 12 years, and which was received from M. Godefroy, Ville d'Avray, near Paris.



2345



2346

■ *J. c. 5 o. pëndula.* (fig. 2345.)—We apply this name to a plant at Kew, which resembles that in the Horticultural Society's Garden, in every respect, except that the habit of the main branches is fastigiate; and the points of the shoots pendulous. It forms a very graceful plant, about 5 ft. high.

■ *J. c. 6 canadensis, J. canadensis* Lodd. *Cat.*, ed. 1836, (fig. 2347.) is a handsome vigorous-growing variety, coming near in foliage to *J. c. nana*; but, as we have only seen a small plant of it in the collection of Messrs. Loddiges, we are unable to depict the particular feature in which it differs from the species. In Lawson's *Manual*, a variety of this name is referred to *J. virginiana*.

■ *J. c. 8 depressa* Pursh *Fl. Amer. Sept.*, ii. 646, is a native of North America, and does not grow above 1 ft. or 2 ft. high; though its root will sometimes cover a space of from 15 ft. to 20 ft. in diameter. It does not appear to have been introduced. Possibly this may be the *J. canadensis* of Lodd. *Cat.*, No. 6. above.

Other Varieties. In Loddiges's *Catalogue*, there are *J. cracòvia* and *J. hibèrnica*, very small plants, but obviously belonging to *J. communis*. There can be no doubt of this, though as in the case of *J. c. canadensis* in the same collection, we cannot point out in what the difference consists. There are other names current in the nurseries, in some of which they are applied to *J. communis*, in others to *J. Sabina*, and in others to *J. virginiana*.

Description, &c. The common juniper, in its native habitats, is a low shrub, seldom rising more than 3 ft. high, and sending out many spreading tough branches, which incline on every side, and are covered with a smooth brown or reddish bark, with a tinge of purple. The bark of the young branches is green; but that of the trunk and old wood is of a greyish brown, cracked and scaly. Leaves narrow, awl-shaped, ending in acute points, placed by threes round the branches, pointing outwards; bright green on one side, and grey on the other; continuing throughout the year. The male



2347

flowers are sometimes on the same plant with the females, though at a distance from them; but they are commonly on distinct plants. The female flowers are succeeded by roundish berries, which are first green, but, when ripe, are of a dark purple or blackish blue colour, covered with a bloom. They continue on the bush two years, and are sessile in the axils of the leaves. They are juiceless, spongy-fleshed, and each contains 3 stones. Each berry is marked at top with 3 raised dots and a 3-forked groove, received at bottom into a very small starred involucre. When planted in a deep sandy loam, the common juniper will grow 15 ft. or 16 ft. high, and will form a handsome bushy shrub.

In Birch Wood, near Farningham, is the juniper of which *fig.* 2350. is a portrait to a scale of 1 in. to 12 ft., for the drawing of which we are indebted to J. F. Christy, Esq. This remarkable tree is 20 ft. high, with a trunk 5 ft. 8 in. in circumference at the base, and 4 ft. 1 in. at 2 ft. from the ground. In the grounds at Pain's Hill is a bush 15 ft. high, and 36 ft. in diameter. At White Knights, there are several hundreds of plants, varying in height from 2 ft. to 12 ft.; but the largest of the species in England is probably that at Wardour Castle, which is 30 ft. high. Of the variety *J. c. 2 suécica*, there is a specimen at Farnham Castle, 40 ft. high. The rate of growth of the taller-growing varieties, in the climate of London, is from 6 in. to 9 in. a year, till the plants are 6 ft. or 8 ft. high, after which they grow more slowly; and their duration is more than a century.

Geography. The juniper is common in all the northern parts of Europe, both in fertile and barren soils, on hills and in valleys, in open sandy plains or in moist and close woods. On the sides of the hills, its trunk grows tall; but on the tops of rocky mountains, and in bogs, it is only a shrub. In England, it is found chiefly on open downs, in a chalky or sandy soil. In the southern countries of Europe, it is less common, except in very elevated situations. According to Pursh, it is found in North America, about rocks, near the falls of rivers, in Canada, and the western part of New York; and the variety *J. c. depréssa* in the state of New York, and particularly in the province of Maine, in rocky or gravelly situations. The common juniper, he adds, "may probably have been originally brought from Europe; but the variety, or, probably, distinct species, *J. c. depréssa*, seems to be really a native." (*Pursh Fl. Amer. Sept.*, ii. p. 646.) In Asia, the common juniper was found by Capt. Webb in Nepal, and on the Bhotan Alps. In all these countries it generally grows in dry soil, and never attains a large size but in soils which are dry and deep.

History. The juniper is mentioned in the *Bible*, in the *First Book of Kings*, as the tree under which the prophet Elijah took refuge in the wilderness of Beersheba, to avoid the persecution of King Ahab. It was known to the Greeks, who used its berries medicinally, though they thought its shade unwholesome. Pliny says the juniper has the same properties as the cedar; adding that, in his time, it grew in Spain to a great size; but that wherever it grows its heart is always sound. He also says that a piece of juniper wood, when ignited, will, if covered with ashes of the same wood, keep on fire a whole year. It is mentioned by Virgil, who says that its shade is hurtful both to men and corn. The species referred to by the classical writers is, in all probability, not the common juniper, but the Phœnician, or some other species of the south of Europe. The botanists of the middle ages appear to have had a high opinion of the virtues of the common juniper. Tragus asserts



2348



2349

the varieties 1s. 6d. each; at Bollwyller, the varieties, 2 francs each. At New York, plants of the Swedish juniper, which requires protection there during winter, are 50 cents each.

■ 2. *J. OXYCEDRUS* L. The Sharp Cedar, or brown-berried, Juniper.

Identification. Lin. Sp. Pl., 1470.; Willd. Sp., 4. p. 854.; Lam. Dict., 2. p. 625.; Desf. Fl. Atl., 2. p. 270.; Lois. Fl. Gall., p. 634.; N. Du Ham., 6. p. 47.
Synonymes. *J. major* Cass. *Spic.*, 54.; *J. in. monspeliensium* Lob. *Sc.*, 2. p. 223.; *J. phœnicea*, &c., *J. Bauh.* *Hist.*, 1. p. 277.; *J. major*, &c., *C. Bauh.*, p. 489.; *Tourn. Inst.*, 589.; *Du Ham. Arb.*, p. 352. t. 128.; *Rail Hist.*, 1413.; *Cedrus phœnicea* Matth. *Valgr.*, 127.; *Oxycedrus* Cass. *Hist.*, p. 33.; *O. phœnicea* Dod. *Pempt.*, p. 853.; the prickly Cedar; le Cade, *Fr.*; Spanische Wachholder, *Ger.*
Engravings. Du Ham. *Arb.*, 2. t. 128.; N. Du Ham., 6. t. 15. f. 2.; our *fig.* 2352. to our usual scale; and *fig.* 2351. of the natural size.

Spec. Char., &c. Leaves in threes, spreading, mucronate, shorter than the berries. (*Willd.*) An evergreen shrub, native of Spain, Portugal, and the south of France. Introduced before 1739; flowering in May and June.

Description, &c. A shrub, closely allied to *J. communis*, from 10 ft. to 12 ft. high, and feathered from the ground. The branches are small and taper, with-



out angles. Berries very large, of a brownish red, and marked with two white lines. This species is said to form a handsome shrub when allowed sufficient space; and to be rather more tender than *J. communis*. In France, an essential oil is distilled from its wood, called *huile de cade*, which is used in veterinary medicine.



There are small plants in the Horticultural Society's Garden, at Kew, and at a few other places; but we have never been able to see any above 1 ft. in height.

■ 3. *J. MACROCARPA* Smith. The large-fruited Juniper.

Identification. Smith in *Fl. Græc. Prod.*, 2. p. 263.; ? Tenore *Syll. Fl. Neapol.*
Synonymes. *J. major*, *baccæ cæruleæ*, *Tourn. Inst.*, 589.
Engravings. Lob. *Icon.*, 2. p. 223. f. 1.; *Tourn. Inst.*, 589. f.; and our *fig.* 2353. of the natural size, copied from the figure of L'Obel.

Spec. Char., &c. Leaves ternate, spreading, mucronate, sharply keeled, one-nerved. Berries elliptical, longer than the leaf. (*Smith Fl. Gr.*, 2. p. 267.) A shrub, a native of Greece, with leaves like those of *J. Oxycedrus*, but the berries are twice as large, elliptic or obovate, and black covered with a violet bloom. There is a specimen in Sibthorp's herbarium, in the Linnean Society. (*Du Ham.*) Berries have been sent to us by the Honourable W. Fox Strangways, under the name of *J. macrocarpa*, (but which were of a brownish red, and only differing from those of *J. Oxycedrus* in size,) accompanied by the following remarks:—"Juniperus macrocarpa is described in Tenore's *Syllog. Fl. Neapol.*, 1832, 8vo. It is common along the sea-shore, particularly near Baia, Cuma, and Licola; and is a low thick bush, having neither the cedar-like spread of the common juniper, nor the upright stature of *J. Oxycedrus*. *J. Oxycedrus* appears to be intermediate between *J. communis* and *J. macrocarpa*; having the small fruit of the former, and the spreading prickly leaves, wide apart, of the latter. It is not common in Italy, but is abundant in Istria and Dalmatia, where it bears the *Viscum Oxycedri*.—*W. Fox Strangways, January 20, 1830.*" Professor Don doubts much whether Tenore's *J. macrocarpa* be any thing more than a variety of *J. Oxycedrus*. As Mr. Strangways has given seeds of Tenore's plant to the Horticultural Society, and to other collections, it will be known in a few years what it is.



■ 4. *J. DRUPACEA* Lab., N. Du Ham. The drupaceous, or large-fruited, Juniper.

Identification. Labillard. *Icon. Plant. Syr. Dec.*, 2. p. 14.; Mart. *MHL.*, No. 11.; Desfont. *Hist. des Arbres et Arbriss.*, 2. p. 558.



2354



2355

Synonymes. *Hæhnel fructus Clus. Hist. Ic.*, 37; *J. major Bellon. Obs.*, 2, p. 162. *Engravings.* Clus. Icon.; Labillard. Icon.; our *fig.* 2354, reduced to our usual scale from the figure of La Billardière; and *figs.* 2355, and 2356, of the natural size, also from the same authority. *Fig.* 2355, shows the scales of the fruit much openner than is usual in Juniperus; it is, however, a correct copy of the original.

Spec. Char. Leaves in threes, spreading, acute, three times shorter than the fruit. Nut 3-celled. (*Labillard.*) A shrub, a native of Syria. Introduced in 1820; but we have not seen the plant.

Description, &c. Stem erect, branched. Branches spreading; branchlets 3-sided. Leaves lanceolate, sessile, somewhat glaucous, with a double line above. Fruit testaceous, often three times as long as the leaves; large, roundish, angular, dark blue, with a glaucous bloom, and marked with six or nine retuse tubercles. Nut subovate, large, with three small cells; very hard, hollowed above with three lines; kernel solitary, oblong, fixed by a pellicle to the bottom of the cell. A native of Mount Casius, and probably the same with the greater junipers observed by Bclionius on Mount Taurus, which he describes as rising to the height of a cypress, and bearing a sweet fruit, the size and shape of an olive, which is eaten by the inhabitants of the mountains. (*Mart. Mill.*) This species was seen by Desfontaines in Paris, in the nursery of M. Cels. Clusius received it from the East, under the name of *Hæhnel*.

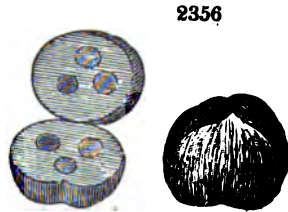

2356

‡ 5. *J. VIRGINIANA* L. The Virginian Juniper, or Red Cedar.

Identification. Lin. Sp. Pl. 1471; Willd. Sp. Pl., 4, p. 853; Michx. Arb. For., 3, p. 42; North Amer. Syl., 3, p. 222; Mart. Mill., No. 6; Ait. Hort. Kew., ed. 2., 5, p. 415.

Synonymes. *J. major americana Rostk. Hist.*, 1413; *J. maxima, &c., Sloan, Lodd. Cat.*, ed. 1836, *Bos. Jard.*, ed. 1837, *Lous. Mem.*, p. 392. *Engravings.* Michx. Arb. For., 3, t. 5; North Amer. Syl., 3, t. 155; and the plates of this tree in our last Volume.

Spec. Char. Leaves in threes, the three growing together at the base; young ones imbricated, old ones spreading. (*Willd.*) An evergreen tree; a native of North America. Introduced before 1664; flowering in May, and ripening its fruit in October.

Varieties.

‡ *J. v. 2 humilis* Lodd. Cat., ed. 1836.—The only plant that we have seen is at Messrs. Loddiges's, and it is there so very small and sickly, that it is difficult to form any opinion respecting it.

‡ *J. v. 3 caroliniana*; *J. caroliniana Du Roi, Mill. Dict.*, No. 2.—Miller says that the lower leaves of this kind are like those of the Swedish Juniper; but that the upper leaves are like those of the cypress; while in the Virginian cedar all the leaves are like those of the Juniper. The name is in Messrs. Loddiges's catalogue for 1837; but, as the plant in their collection is dead, we can say nothing as to the difference between it and the species.

Other Varieties. The red cedar varies exceedingly from seed. At White Knights, where there are some hundreds of trees, some are low and spread-

ing, and others tall and fastigate; some bear only male blossoms, and others only female ones. The foliage, in some, is of a very light hue; in others, it is glaucous; and in some a very dark green. The fruit, also, varies considerably in size; but, perhaps, the most striking variety is one in which the branches are decidedly pendent. Miller mentions a variety which has leaves like a cypress.

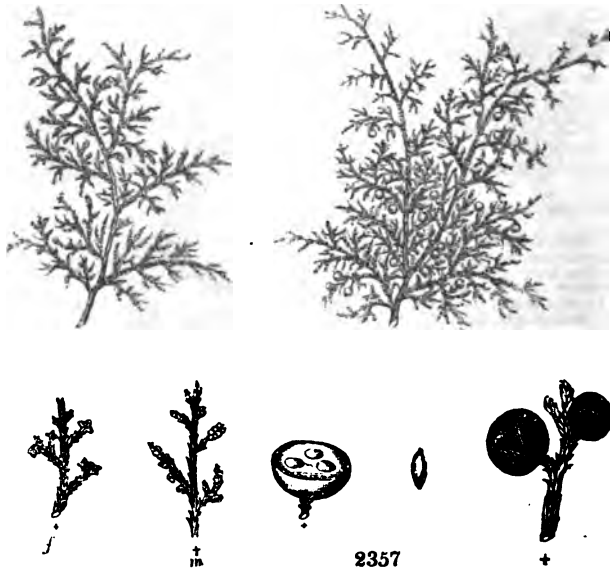

Description, &c. The red cedar, in its native country, is a tree from 40 ft. to 45 ft. high, with a trunk from 1 ft. to 1 ft. 6 in. in diameter. Its branches, which are numerous and close, spring near the earth, and spread horizontally; and the lower limbs are, during many years, as long as the body of the tree. The trunk decreases so rapidly, in diameter as it ascends, that the largest specimens rarely afford timber for ship-building more than 11 ft. in length. The diameter of the wood is also very much diminished by deep oblong furrows in every part of the trunk, occasioned by the large branches persisting after they are dead. (*Michx.*) The wood is fragrant, compact, fine-grained, and light; though heavier and stronger than that of either the white cedar or the deciduous cypress. The bark is thin and scaling off. The leaves are fastened at the base by their inner side, in the new shoots, imbricated in four rows, giving them the appearance of being quadrangular; the year following these spread from the branch at an acute angle, and appear to be disposed in six rows, or longitudinal phalanxes. The male and female flowers are small, not conspicuous, and borne separately on the same or on different trees. The berry is dark blue, and covered with a whitish resinous meal. The rate of growth, in the climate of London, is 10 ft. or 12 ft. in ten years; and the duration of the tree is upwards of a century. The largest specimens that we have seen are at Whitton, where there is one 60 ft. high, with a trunk 2 ft. in diameter; at Pain's Hill, where there is one 40 ft. high, with a trunk 2 ft. in diameter, and the diameter of the head 40 ft.; and at Syon, where there is the tree figured in our last Volume.

Geography and History. According to the elder Michaux, Cedar Island, in Lake Champlain, nearly opposite to Burlington, in lat. 44° 25', is the most northern boundary of the red cedar. Eastward, it is found near Wiscasset, a

small town of the district of Maine, at the mouth of the Kennebeck; whence it spreads, without interruption, to Cape Florida, and thence round the Gulf of Mexico, to beyond St. Bernard's Bay, a distance of more than 3000 miles. As it retires from shore, it becomes gradually less common and less vigorous; "and, in Virginia and the more southern states, it is rare at the point where the tide ceases to flow in the rivers: farther inland, it is seen only in the form of a shrub, in open dry sandy places. In the western states, it is confined to spots where the calcareous rock shows itself naked, or is so thinly covered with mould, as to forbid the vegetation of other trees. Though the red cedar grows naturally in the district of Maine, and in the islands of Lake Champlain, it is repressed by a winter as intense as that of the north of Germany; and develops itself less vigorously than in Virginia and farther south, where the soil and climate are favourable to the growth of the tree, and the perfection of its wood. Upon the downs, it is often buried in the sand cast up by the waves, except the summit of the branches, which appear like young trees above the surface. When unencumbered with sand, as in the middle of the islands, and on the borders of the narrow sounds which flow between them and the main, it attains the height of 40 ft. or 45 ft.; but it would be difficult to meet with trees of this size northward of the river St. Mary, within the ancient limits of the United States." (*Michx.*) According to Pursh, it is found in dry and rocky woods and fields, from the province of Maine to Georgia. It is mentioned by Parkinson; but he says that he has only seen the wood. It is said, in the *Hortus Kewensis*, to have been introduced before 1664, by Evelyn; and it has long been one of the commonest evergreens in British shrubberies. It endures the open air in Paris, and in Central Germany.

Properties and Uses. The name of red cedar has reference to the heart wood of this tree, which is of a beautiful red, while the sap wood is perfectly white. It is so strong and durable, that it would be preferred, in America, to every other kind of wood for many rural purposes, if it were not become so scarce in that country as to be very dear. According to Michaux, the barriers of the side walks in the streets of Philadelphia are made of this wood: they are 10 ft. or 11 ft. long, and 8 in. wide; and they are sold at 80 cents each; while those made of white cedar cost only 16 or 17 cents. The wood of the red cedar is admirably fitted for subterranean water-pipes; but it is rarely used for that purpose, from the difficulty of procuring trunks of sufficient size. The wood of the red cedar grown in the southern maritime states is reckoned the best; and it is used, combined with live oak, for the upper part of the frames of vessels; it is also generally used, in the southern states, for coffins. In Philadelphia the turners make their large stop-cocks of it; they also make very elegant little tubs, neatly wrought, and hooped with brass, resembling the Scotch bickers, of alternate staves of the heart and sap wood. It makes admirable fuel; and, when used for this purpose on board the steam-boats, the volumes of smoke which issue from the boiler furnaces are said to perfume the air for several miles in the track of the boat, or in the direction of the wind. The timber is imported into England for the manufacture of black-lead pencils; though the Bermuda juniper is preferred for that purpose. In Britain, the red cedar it is not planted as a timber tree; though, from the size which it attains in deep dry sandy soils, it might be worth while to plant it in masses for this purpose. As an ornamental tree, or large shrub, it is highly valued, either for planting singly on lawns, or in groups along with other trees and shrubs. It is more especially adapted for grouping with other Cupressinæ, the pine and fir tribe, and the yew.

Soil, Propagation, Culture, &c., as in the common juniper.

Statistics. In the Environs of London. At Ham House, Essex, it is 38 ft. high, with a trunk 1 ft. 9 in. in diameter; in the Fulham Nursery, 12 years planted, it is 15 ft. high. — South of London. In Devonshire, at Bilton, 10 years planted, it is 12 ft. high. In Hampshire, at Strathfieldsaye, it is 47 ft. high, with a trunk 2 ft. in diameter. In Somersetshire, at Nettlecombe, 60 years planted, it is 36 ft. high, diameter of the trunk 2 ft., and of the head 25 ft. In Surrey, at Bagshot Park, 20 years planted, it is 22 ft. high. In Sussex, at Westdean, 14 years planted, it is 29 ft. high. — North of

London. In Bedfordshire, at Southill, it is 35 ft. high, diameter of the trunk 2 ft. 5 in., and of the head 27 ft. In Berkshire, at White Knights, 34 years planted, it is 30 ft. high. In Cambridgeshire, at Wimpole, 100 years old, it is 32 ft. high, diameter of the trunk 3 ft. In Essex, at Braybroke, 51 years planted, it is 32 ft. high; at Hylands, 10 years planted, it is 16 ft. high. In Gloucestershire, at Doddington Park, 27 years planted, it is 18 ft. high. In Hertfordshire, at Cashibury, 30 years planted, it is 34 ft. high. In Leicestershire, at Elvaston Castle, 35 years planted, it is 31 ft. high, diameter of the trunk 1 ft. 8 in.; at Whatton House, 20 years planted, it is 24 ft. high. In Nottinghamshire, at Clumber Park, it is 36 ft. high. In Staffordshire, at Robeston Hall, 50 years planted, it is 32 ft. high. In Suffolk, at Finborough Hall, 70 years planted, it is 60 ft. high; at Sretton Rectory, 50 years old, it has three stems, the total circumference of which is 11 ft. In Warwickshire, at Cosme Abbey, 60 years planted, it is 44 ft. high, diameter of the trunk 1 ft. 9 in., and of the head 20 ft. In Worcestershire, at Croome, 50 years planted, it is 65 ft. high, the diameter of the trunk 1 ft. 8 in., and of the head 30 ft. In Yorkshire, at Hackness, 40 years planted, it is 14 ft. high.—In Scotland. In the environs of Edinburgh, at Gosford House, 50 years planted, it is 15 ft. high; at Dalhousie Castle, 20 years planted, it is 16 ft. high. In Berwickshire, at the Hirsel, 30 years planted, it is 21 ft. high. In Haddingtonshire, at Tynningham, 23 years planted, it is 17 ft. high. In Roxburghshire, at Minto, 65 years planted, it is 35 ft. high. In Aberdeenshire, at Thainston, it grows about 11 in. a year. In Perthshire, at Taymouth, 50 years planted, it is 36 ft. high. In Ross-shire, at Brahan Castle, 50 years planted, it is 54 ft. high. In Stirlingshire, at Blair Drummond, it is 40 ft. high.—In Ireland. In the environs of Dublin, in the Glasnevin Botanic Garden, 30 years planted, it is 16 ft. high. In Fermanagh, at Florence Court, 50 years planted, it is 40 ft. high. In Louth, at Oriel Temple, 35 years planted, it is 26 ft. high.—In France. At Paris, in the Jardin des Plantes, 25 years planted, it is 52 ft. high, the diameter of the trunk 1 ft., and of the head 25 ft.; in the Botanic Garden at Toulon, 36 years planted, it is 29 ft. high. At Avanches, in the garden of M. Brunel, 29 years planted, it is 24 ft. high, the diameter of the trunk 1 ft. 6 in., and of the head 29 ft.—In Hanover, in the Göttingen Botanic Garden, 50 years planted, it is 40 ft. high.—In Bavaria, in the Botanic Garden, Munich, 30 years planted, it is 12 ft. high.—In Austria, at Vienna, in the University Botanic Garden, 30 years planted, it is 25 ft. high; at Luxenburg, 30 years planted, it is 20 ft. high; at Brück on the Leytha, 45 years planted, it is 30 ft. high.—In Prussia, at Berlin, at Sans Souci, 50 years planted, it is 40 ft. high; in the Pfauen Insel, 40 years planted, it is 26 ft. high.—In Sweden, in the Botanic Garden at Lund, it is 22 ft. high.—In Italy, at Monza, 29 years planted, it is 30 ft. high.

Commercial Statistics. Price of berries, in London, 1s. 3d. per quart; of seedling plants, 5s. a hundred; plants from 12 in. to 18 in. high, 75s. a hundred. At Bollwyller, plants in pots are 1 franc each; or seedlings, one year transplanted, per hundred, 30 francs. At New York, plants are 25 cents each.

§ 6. *J. BERMUDIA'NA* L. The Bermudas Cedar.

Identification. Lin. Sp. Pl., 1471.; Reisch., 4. p. 276.; Herm. Lugdb., t. 347.; Rail Hist., 1414.

Synonyme. *Cedrus Bermudas* Ray's Letters, p. 171.

Engraving. Herm. Lugdb., t. 347.; and our *fig.* 2358. of the natural size, from a young plant at Messrs. Loddiger's.

Spec. Char. Leaves in threes; upper in pairs, decurrent, awl-shaped, spreading, acute. (*Willd.*) A tall tree, a native of the Island of Bermudas. Introduced before 1683, and flowering in May and June.

Description, &c. A lofty tree, with loose, thin, reddish bark, and very fragrant wood. When young, it has acutely pointed leaves, which spread open, and are placed by threes round the branches; but, as the trees advance in age, their leaves alter, and become very short; lying over each other by fours round the branches, so as to make the branchlets appear 4-cornered. The berries are produced towards the end of the branches, and are of a dark red colour, inclining to purple. According to Ray's *Letters*, p. 171., it was introduced in 1683; but, in Martyn's *Miller*, it is said that it was first cultivated by the Earl of Clarendon, in 1700. The wood is much used, in the West Indies, for wainscoting, and different articles of furniture, as it is never attacked by cockroaches or other insects. It is imported into England for the purpose of making black-lead pencils; and shavings of it, under the name of cedar shavings, are used to put in drawers, &c., to keep away moths. The tree, being rather tender in the climate of London, is not frequent in collections; but plants may be obtained in the principal nurseries. The largest specimen which we have seen is at Hendon Rectory, where it is about 2 ft. high. There are plants in the Fulham Nursery, and in the Horticultural Society's Garden. Price of plants, in the London nurseries, 2s. 6d. each. At Bollwyller and New York, it is a green-house plant.



2358

J. nepalensis Hort., *Cupressus nepalensis* Hort. Seeds of this species were sent to the Horticultural Society's Garden, by Mr. Ward of the Isle of Wight, in 1834, and many plants raised from them. They are of vigorous growth, and have the general appearance of the common red cedar. The largest plant in the Horticultural Society's Garden is 2 ft. high.

§ ii. *Sabina*. — *Leaves of the adult plant imbricated.* D. Don.

■ 7. *J. SABI'NA.* The common Savin.

Identification. Lin. Sp., 1472.; Hort. Cliff.; Woodv. Med. Bot., p. 256. t. 94.; Gouan Hort. Monsp., 510.; Hall. Helv. No. 1662.; Scop. Carn., No. 1238.; Gmel. Sib., 1. 183. No. 34.; Pall. Itin., 3. 368.; Fl. Ross., 1. 2. 15. t. 56. f. 2.; Mart. Mill., No. 5.; Willd. Sp. Pl., 4. 852.; Ait. Hort. Kew., 5. p. 414.; Du Ham. Arb., 2. t. 62.; Desf. Hist. des Arb., &c., 2. p. 559.
Engrossings. Woodv. Med. Bot., t. 94.; Pall. Fl. Ross., t. 56. f. 2.; Du Ham. Arb., 2. t. 62. 63.; Bull. Herb., t. 139.; and our fig. 2364.

Spec. Char., &c. Leaves oval, opposite, imbricated, somewhat acute, convex on the back; the male catkins pedunculate. Berries of a blackish blue, generally monospermous. (*N. Du Ham.*) A low shrub, introduced before 1548, and flowering in March and April.

Varieties.

- *J. S. 1 cupressifolia* Ait. Hort. Kew., v. p. 414.; *J. lusitanica* Mill. Dict., No. 11.; *Sabina* Dod. Pempt., 854.; *S. folio Cupressi* Bauh. Pin., 487., *Du Ham. Arb.*, ii. t. 62., *Rau Hist.*, 1415.; la *Sabine mâle*, Fr.; the Cypress-leaved Savin; (*fig. 2359.*) has the leaves like those of a cypress.

- *J. S. 2 tamariscifolia* Ait., l. c.; *Sabina folio Tamarisci Dioscoridis* Bauh., l. c.; *J. Sabina* Mill. Dict., No. 10.; la *Sabine femelle*; the Tamarisk-leaved, or berry-bearing, Savin. (*fig. 2360.*)

- *J. S. 3 folius variegatis* Mart. Mill. has the leaves variegated.

There are plants of all the above varieties in the Horticultural Society's Garden.

- *J. S. 4 prostrata*, *J. prostrata* Michx., *J. repens* Nutt., *J. hudsonica* Lodd. Cat., 1836, and our *fig. 2361.*, is a low trailing plant, seldom rising above 6 in. or 8 in. in height, but rooting into the soil, and extending its branches to a great distance.

- *J. S. 5 alpina*, *J. alpina* Lodd. Cat., 1836, (*fig. 2362.*) is a procumbent plant, more slender in its habit, but, in other respects, only slightly different from *J. prostrata*. The plant in the Horticultural Society's Garden is about 18 in. high.

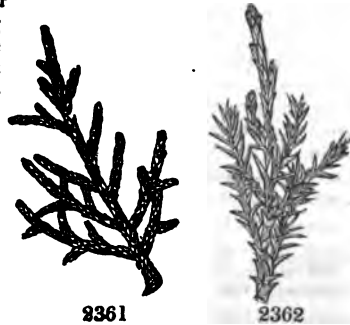

Description. &c. The savin, though generally seen, in British gardens, as a low spreading shrub, has sometimes an upright trunk, clothed in a reddish brown bark, and rising to the height of 10 ft. or 12 ft., or even higher. Its branches are nearly straight, very much ramified, and form, with the trunk, a regular pyramid. Its young branches are entirely covered with imbricated leaves, which have a very strong and disagreeable odour, and a

very bitter taste. The male flowers are disposed in small catkins, on peduncles covered with little imbricated leaves, and are dispersed laterally along the youngest branches. The female flowers are generally produced on separate trees, and are disposed in the same manner: they are succeeded by oval berries, of a blue so deep as to be almost black, and are about the size of a currant: they generally contain only one seed, which is long, oval, and somewhat compressed. The variety *J. S. tamariscifolia* is a much lower shrub, with spreading branches, and longer leaves, which are only half-opened. (*N. Du Ham.*) Miller says that the cypress-leaved savin is by many supposed to be only an accidental variety; but the branches grow more erect, the leaves are shorter, and end in acute points, which spread outwards. It rises to the height of 7 ft. or 8 ft., and produces great quantities of berries; whereas the tamarisk-leaved savin very rarely produces either flowers or seeds in British gardens. (*Mart. Mill.*) This last-mentioned variety sends out its branches horizontally, and seldom rises more than 3 ft. or 4 ft. high, but spreads to a considerable distance every way. The leaves are very short, acutely pointed, and running over each other along the branches, with the ends pointing upwards. The berries are smaller than those of the common juniper, but of the same colour, and a little compressed. The savin is a native of Spain, Italy, part of France, and the Levant. Professor Pallas says that it is also found in the Taurian Chersonese, where it often has a trunk 1 ft. in diameter, and an upright habit of growth, like a cypress; whereas in the Tanais it is procumbent, the branches extending on the sand several fathoms. The wood very much resembles that of *J. lycia*, but has a more unpleasant smell. (*Mart. Mill.*) Both the two first-mentioned varieties, or, rather forms of the species, were in cultivation in British gardens before 1548, as they are mentioned in Turner's *Names of Herbes, &c.*, published in that year. The leaves of the savin are used in medicine, as a diuretic; but, if taken in large quantities during pregnancy, as well in the human species as in domestic animals, will produce abortion. When dried and pulverised, they are used for cleansing foul ulcers. The upright savin was formerly much used in England, and still is in some parts of France, in topiary work, as it bears the sheers very well. In France, it is employed in the same manner as the common juniper, to form screens (*rideaux de verdure*), and to cover walls which it is wished to conceal. The Baschkirs, a people of Russia, between the Volga and the Oural, use fumigations of savin to cure the diseases of children; they also believe it to have a great effect against witches, for which purpose they hang branches of it at the doors of their houses. The ancient Germans, it is said, gave savin to their chargers to give them ardour. In Britain, the savin is a very common ornamental evergreen, thriving in the poorest soils, and in exposed situations; in the latter remaining an humble prostrate shrub, and in the former attaining a considerable size. Price of plants, in the London nurseries, of the species 6*d.* each, and of the varieties 1*s.* 6*d.*; at Bollwyller, of the species 1 franc 50 cents, and of the varieties 2 francs; and at New York, 50 cents each.

■ *J. DAURICA* *Pall.* The Daurian Juniper.

Identification. *Pall. Ross.*, 2. p. 13. t. 55.; *Gmel. Sib.*, 1. p. 185. No. 35.; *And. Rep.*, 534.; *Mart. Mill.*, No. 12.; *Ait. Hort. Kew.*, ed. 2., 5. p. 414.; *Lodd. Cat.*, ed. 1836.

Engravings. *Pall. Ross.*, t. 55.; our *Ag.* 2365. to our usual scale; and *Ag.* 2366. of the natural size.

Spec. Char., &c. Leaves opposite, acute, imbricate-decurrent, spreading, and awl-shaped. (*Willd.*) A prostrate shrub, a native of Dauria. Introduced in 1791, by John Bell, Esq., and flowering from June to August.

Description, &c. The limbs of this juniper are large and very thick, and are usually found lying prostrate on the rocks. The branches are dichotomous, and covered with imbricated young leaves, and the remains of old leaves, which change into acuminate scales before they fall off. The leaves differ in



2363

the different sexes : in the male, they are decurrent, with a short awl-shaped



point, and closely imbricated, with here and there a longer needle-shaped leaf on the branches. This kind, though principally bearing male catkins, has sometimes on the tips of the branchlets a few female flowers. The female tree is covered with berries all over the branches, except the outer and younger shoots; and the leaves, like those of *J. Oxýcedrus*, are sharp and needle-shaped, spreading



outwards from the base, and are almost as long as the berries. The berries are globular, more bitter than those of the common juniper, blackish when ripe, but appearing blue from the white meal that covers them; peduncled, as it were, by standing on a leafless thickened branchlet, and containing one or two stones. It is a native of Siberia, but is totally different from *J. lycia*. (*Pall. Ross.*, ii. p. 13.) There are plants at Messrs. Loddiges's.

‡ 9. *J. PHŒNICÆA* L. The Phœnician Juniper.

Identification. Lin. Sp. Pl., 1471.; Willd. Sp., 4. p. 855.; Mart. Mill., No. 9.; Lam. Dict. Encyc., 2. p. 628.; Desf. Fl. Atlau., 2. p. 571.; Pall. Ross., 2. p. 14. 57.; Alt Hort. Kew., 5. p. 415.; N. Du Ham., 6. p. 47.; Lodd. Cat., ed. 1836.; Bon Jard., ed. 1837.

Synonymes. *J. major* Dioscoridis Clus. Hist., 33.; *Cedrus phœnicæa media* Lob. Icon., 2. p. 221.; *C. lycia retusa* J. Bask. Hist., 1. lib. 9. p. 300.; *C. folio cupressi major*, &c., *C. Bask. Pin.*, 487.; *Tourm. Inst.*, 588.; *N. Du Ham. Arb.*, 1. p. 140.; *Oxycedrus lycia* Dod. Pempt., 853.; *Genévrier de Phœnicie*, Fr.; *dichtnädiger Wachholder*, Ger.

Engravings. Du Ham. Arb., 1. t. 52.; Pall. Ross., t. 56.; N. Du Ham., 6. pl. 17.; and our *Ag.* 2367.

Spec. Char., &c. Leaves in threes, obliterated, imbricated, obtuse. (*Willd.*) A native of the south of Europe, Russia, and the Levant; cultivated in Britain in 1683, and flowering in May and June.

Description, &c. The Phœnician juniper is a shrub, the trunk of which is loaded with numerous branches, disposed so as to form a pyramid, and both trunk and branches are covered with a reddish brown bark. The young branches are slight, entirely covered with very small leaves, which are disposed in threes opposite to each other, closely covering the surface of the branches, and laid one upon another like scales. These leaves are oval, obtuse, somewhat channeled, and convex on the back, perfectly smooth. On some of the branches, a few sharp linear leaves are found, which are about 3 lines long, and quite open. The male and female flowers are sometimes found on the same tree, but they are generally on different trees. The form and disposition of the male and female flowers closely resemble those of *J. Sabina*. The berries are about the size of a pea, and of a pale yellow when ripe, which is not till the end of two entire years. They generally contain 9 bony seeds in each, of an irregular oval, slightly compressed and angular: the pulp is dry and fibrous, in the middle of which are 3 or 4 bladders, filled with a sort of resinous fluid. The Phœnician juniper was first cultivated in Britain by Mr. James Sutherland, of the Botanic Garden, Edinburgh, in 1683. It is now occasionally to be met with in collections; but is

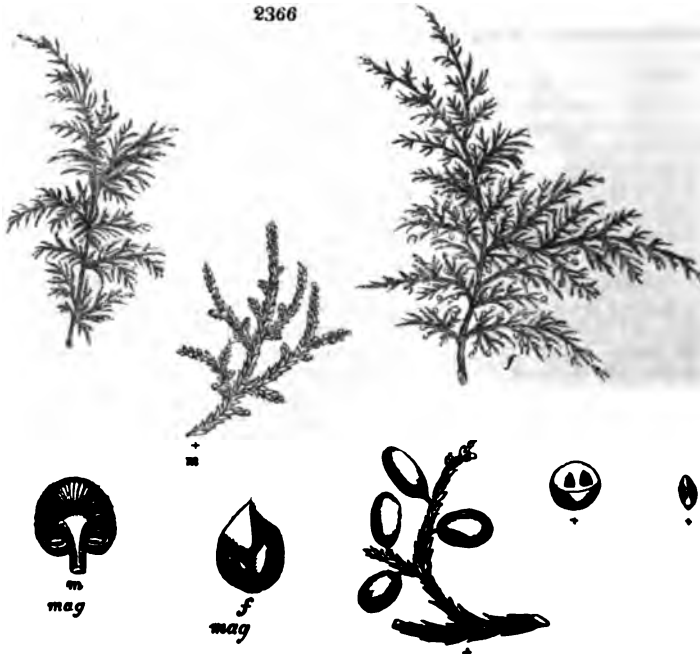

much less common than so fine a shrub deserves to be. The plant in the Horticultural Society's Garden, after being 10 years planted, is 10 ft. high. In the Botanic Garden at Toulon, 48 years planted, it is 19 ft. high, and the diameter of the trunk 1 ft. 2 in. Plants, in the London nurseries, are 2s. 6d. each; and at Bollwyller, 3 francs.

n. 2. 10. *J. (P.) LY'CIA L.* The Lycian Juniper.

Identification. Lin. Sp., 1471; Willd. Sp. Pl., iv. p. 855; Pall. Ross., ii. p. 14. t. 56; Alt. Hort. Kew., v. p. 415; Lodd. Cat., ed. 1836.
Synonymes. *J. p. ß lycia* N. Du Ham., vi. p. 47.; *Cedrus phoenicea altera* Plinii et Theophrasti Lob. Ic., ii. p. 221; *C. folio Cupressi*, &c., C. Bauh. Pin., p. 487.
Engravings. Pall. Ross., t. 56.; N. Du Ham., 6. t. 17.; and our fig. 2367., and fig. 2368. from Pallas.

Spec. Char., &c. Leaves in threes, imbricate on all sides, ovate, obtuse.

(Willd.) Miller describes the Lycian cedar as having its branches "growing erect, and covered with a reddish brown bark. Leaves small, obtuse. Male flowers at the ends of the branches, in a conical ament; and the fruit single from the axils below them, on the same branch. Berries large, oval, and, when ripe, brown." According to Pallas, *J. lycia* is an entirely prostrate shrub, with the trunk branching from the very bottom, and often thicker than the human arm. This, and the branches, are often variously deformed, with scarcely any outer bark. The wood smells very strong, like that of the Bermudas cedar. Branches and branchlets wand-like, and covered with a testaceous bark. Shoots dark green, dichotomous, and imbricate with scale-formed sharp leaves. Berries terminal, globular, middle-sized, nearly black when ripe, and covered with a glaucous bloom; containing 3 or 4 stones. Pallas adds that it greatly resembles the dwarf savin, and that it differs principally in the greater thickness of the shoots,



2367

and in the leaves being acute and less clustered. Native of the south of Europe, the Levant, and Siberia. It was cultivated in 1759, by Miller, who received it from Spain and Italy. In its native climate it produces the resinous gum called olibanum, which has a strong smell, and a bitterish and somewhat pungent taste. When burned, it diffuses a fragrant smell, and is supposed to be the incense which was used by the ancients in their religious ceremonies (though not the same as the substance known by that name in the shops.) It is much employed by the Roman Catholics, in their churches, for similar purposes. It is used in medicine, as an astringent. The only plants that we have seen of it were quite young; that in the Horticultural Society's Garden being, in 1837, only 2 ft. high; the upper part of the plant so closely resembling *J. phœnicea* as scarcely to be distinguished from it, but the lower part with the leaves glaucous on both sides, and 4-rowed. There is a large plant at Boyton, of which we have received specimens from Mr. Lambert, and the shoots of which were covered with a white resinous matter, like minute scales. Mr. Lambert describes his plant as hardy, very much branched, and 6 ft. or 8 ft. high. It is the only plant, he says, which he has seen of the species.



2368

‡ 11. *J. THURIFERA* L. The incense-bearing, or Spanish, Juniper.

Identification. Lin. Sp., 1471; Willd. Sp. Pl., 4 p. 851.; Alt. Hort. Kew., ed. 2., 5. p. 413.; Mart. Mill., 1.; Lodd. Cat., ed. 1836.

Synonymes. *J. hispanica* Mill. Dict., No. 13., *Lam. Encyc. Dict.*, 2. p. 626., *N. Du Ham.*, 6. p. 50.; *Cedrus hispanica*, &c., *Tourne. Inst.*, p. 568.

Engraving. Fig. 2368, from a specimen received from Mr. Lambert.

Spec. Char., &c. Leaves imbricate in 4 rows, acute. (*Willd.*) A tree, a native of Spain and Portugal; cultivated in 1752, by Miller; and flowering in May and June.

Description, &c. An evergreen low tree, growing to the height of from 25 ft. to 30 ft., and sending out many branches, so as to form a pyramidal head. The leaves are acute, and lie over each other in four rows, so as to make the branches appear four-cornered. Berries very large, and black when ripe. There is a tree at Mr. Lambert's seat at Boyton, which, in 1837, was 28 ft. high, with a trunk 9 in. in diameter; one at Bagshot Park, 12 years old, which is 12 ft. high; and one at Croome, 40 years planted, which is 30 ft. high: there are also plants in the Horticultural Society's Garden, and in the Fulham Nursery, in both places 3 ft. high. Price of plants, in London, 3s. 6d. each; at Bollwyller, 3 francs.



2369

‡ 12. *J. EXCELSA* Willd. The tall Juniper.

Identification. Willd. Sp. Pl., 4. p. 852.; Alt. Hort. Kew., ed. 2., 5. p. 413.; Laws. Man., p. 369.; Pursh Fl. Amer. Sept., 2. p. 647.; Royle Illust.; Lodd. Cat., ed. 1836; Bon Jard., ed. 1837.

Synonymes. *J. Sabina* var. *Pall. Ross.*, 2. p. 15.; Himalaya Cedar-wood.

Engraving. Fig. 2370, from a plant about 2 ft. high.

Spec. Char., &c. Leaves opposite, somewhat obtuse, with a central gland; 4-ranked and imbricate; slender, acute, disposed in threes, and spreading. Stem arboreous. (*Willd.*) A tall evergreen tree. Introduced in 1806.

Description, &c. A very handsome and elegant tree, with an upright trunk, and slightly pendulous branches. Leaves opposite, imbricated in 4 rows, and having a raised line on the back. This species has a very extensive geographical range. It was first discovered in Siberia, by Pallas; and it was introduced in 1806, by Sir Joseph Banks. Some years afterwards, it was discovered

in North America, on the banks of the waters of the Rocky Mountains, by Mr. Lewis (see *Pursh Fl. Amer. Sept.*, ii. p. 647.); and, since, it has been found on the Himalayas, by Captain Webb, in Gossainthan, Kamaon, and on the confines of Tartary. It is a very free grower; and there are plants at Messrs. Loddiges's, in the Horticultural Society's Garden, and in the Fulham Nursery. There is a large tree of this species in the Jardin des Plantes, 32 ft. high, diameter of the trunk 1 ft. 3 in., and of the head 25 ft.

■ 13. *J. SQUAMATA* D. Don. The scaled Juniper, or creeping Cedar.

Identification. Lamb. Pin., 2. No. 66.; D. Don Fl. Nepalensis, p. 55.; Boyle Illust.

Spec. Char., &c. Leaves in threes, closely imbricated, ovate-oblong, more or less pointed; remaining on after they are withered; young ones inflexed at the apex, as if obtuse. Berries ovate, umbilicate on the top. Branches and branchlets crowded round. Stem prostrate. (Lamb. Pin.) A large, decumbent, much-branched shrub. Branches large, 3 ft. to 6 ft., reclinate; apices ascending. Bark brownish purple, scaling off. Branchlets crowded round, closely imbricated with leaves. Leaves in threes, oblong, closely imbricated, of an intense green, very smooth, externally convex; young ones generally obtuse, with an inflexed point; adult ones more or less pointed; when withered, always having a very long point, persistent, and adhering to the branches like scales; whence the name. Berries numerous, roundish-ovate, solitary, red, on a short scaly footstalk, umbilicate at the summit, a little larger than in the common juniper. (Lamb. Pin.) Found in Narainhetty, in Nepal, by Dr. Hamilton; and on the Bhotan Alps, by Captain Webb: flowering in August. It was introduced in 1824; but we have not seen the plant.



2370

■ 14. *J. RECURVA* Ham. The recurved Nepal Juniper.

Identification. Ham. MSS., as quoted in Don's Flora Nepalensis, p. 55.
Engraving. Our fig. 2371.

Spec. Char., &c. Leaves linear-lanceolate, mucronate loosely imbricated, smooth, convex beneath. Berries roundish oval, tubercled. Branches and branchlets recurved. (D. Don.) A shrub, found by Dr. Hamilton in Narainhetty, in Nepal, and flowering there in February. There is a plant in the Horticultural Society's Garden, which, in 1837, after having been four years planted, was 3 ft. high; and one at Messrs. Loddiges's, 4 ft. high, which ripened fruit, and from which our figure was taken. It forms a graceful bush, or low tree, from its pendulous habit; and it is readily distinguished from all the other species, not only by this circumstance, but by the mixture of its brown, half-decayed chaffy leaves of the past year, with its greenish grey leaves of the present year. The bark is rough, brown, and soon begins to curl up; when it has a rough appearance, and ultimately scales off.



2371

■ 15. *J. UVI'FERA* D. Don. The grape-bearing, or large-fruited, Juniper.

Identification. Lamb. Pin., 2. No. 67.

Spec. Char., &c. Leaves ovate, obtuse, adpressed, imbricated in 4 rows. Branchlets short, erect, crowded, knotted. Drupes terminal, roundish. (Lamb. Pin.) A decumbent, much branched shrub. Branches ascending, round, covered with a greyish brown scaly bark. Branchlets short, erect, crowded, closely imbricated with leaves, knotted, twiggly. Leaves ovate, obtuse, adpressed, imbricated in 4 rows, quite entire, coriaceous, glabrous, smooth. Drupes roundish, purple, about the size and shape of a small grape, solitary, on the apex of the branchlets, sessile, smooth. Abundant about Cape Horn, and the only species in the southern hemisphere. It was introduced from Cape Horn by Mr. Middleton, probably about the beginning of the present century, but we have not seen a plant. (See Lambert.)

‡ 16. *J. BARBADE'NSIS* L. The Barbadoes Juniper.

Identification. Lin. Sp. Pl., 1471.; Willd. Sp. Pl., 4. p. 851.; Reich., 4. p. 276.; Pluk. Phyt., t. 197. f. 4.; Mart. Mill., No. 2.; Pursh Fl. Amer. Sept., 2. p. 647.

Synonymes. *J. bermudiana* Hort. Aug., t. 1. f. 1., *Brown Jam.*, 302.; Jamaica Berry-bearing Cedar.

Engraving. Pluk. Phyt., t. 197. f. 4.

Spec. Char., &c. All the leaves imbricate in 4 rows; the younger ovate, the older acute. (Willd.) A large timber tree, with very widely spreading branches. The bark is rugged, of a very dark

brown, and splits off in strings. The leaves are extremely small, and always imbricate. The berries are smaller than those of the Bermudas cedar, and are of a light brown colour when ripe. It is a native of the West Indies, and also, Pursh says, on the authority of Michaux, of the coast of Florida. It was cultivated in England in 1759, by Miller, but we have not seen the plant.

■ 17. *J. CHINENSIS* L. The Chinese Juniper.

Identification. Lin. Syst., 894.; Reich., 4. 277.; Mant., 137.; Lour. Coch., 636.

Engravings. Our figs. 2372. and 2373.

Spec. Char. Leaves decurrent, imbricate-spreading, clustered; stem leaves in threes, branch leaves in fours. (*Willd.*)

Description, &c. According to Martyn's *Miller*, Loureiro describes the Chinese juniper as a shrub of 3 ft. in height, with twisted and very spreading branches. Leaves awl-shaped, hardish, dark green:



2372

according to Linnæus, spreading, green on both sides, more clustered than in the other sorts, fastened at the base, scarcely pungent, and extremely distinct by the density of the leaves. (*Mant.*) There are two plants in the Horticultural Society's Garden bearing the name of *J. sinensis*, male



2373

and female, 12 ft. and 10 ft. high. The leaves are green, short, and imbricated; the fruit rough, angular, and dry; and the plants do not accord, in some respects, with the species described by Loureiro. Specimens of the plant in the Horticultural Society's Garden were, however, compared by Professor Don with the Linnæan specimens, and he is of opinion that it is correctly named.

J. c. 2 Smithii. A species of *Juniperus* in the Horticultural Society's Garden (*fig. 2374.*), without a name, and said to have been received from Smith of Ayr, about 1825 or before, bears a close resemblance to *J. chinensis*, but the fruit is rather more angular. The plant in the garden is of vigorous growth, 8 ft. or 10 ft. high; it produces both male and female blossoms, and ripens fruit. There can be no doubt that it is not a European plant; nor are there any species at all resembling it from North America. We have been informed that there is a species in some of the Scotch nurseries raised from Nepal seeds, and commonly called *Juniperus nepalensis*, which bears so close a resemblance to Mr. Smith's plant, as to leave little doubt of their identity. Mr. Smith, to whom we have written on the subject, can give us no satisfactory information; and it even appears to us doubtful if the plant in the Horticultural Society's Garden was received from him. We have ventured to give it a name, merely to prevent it from being lost sight of; and because we should wish to see such a vigorous-growing healthy species propagated, and introduced into collections.



2374

App. i. *Kinds of Juniperus mentioned in Books, but of which very little is known.*

J. fastidissima Willd. Sp. Pl. approaches *J. excelsa*, but has not been yet introduced.
J. capensis Lam. Dict., p. 626., Desf. Hist. des Arb., &c., Dum. Bot. Cult., 6 p. 444., has an upright trunk, and numerous branches, which are short and close together. The leaves, at the extremity of the branches, are in threes, linear, sharply pointed, and glaucous; the others are smaller and imbricated. Lamarck mentions having sent this species to Kew; but it is not included in the *Hortus Kewensis*. Desfontaines says that the species is rare and little known, and that it requires protection during winter.

CHAP. CXIV.

OF THE HARDY LIGNEOUS PLANTS OF THE ORDER EMPETRA'CEÆ.

Identification. Nutt. Gen., 2. 233; Don in Edinb. New Phil. Journ., 1826; Hook in Bot. Mag., t. 2758; Lindl. Syn., 224; Bart. Ord. Nat., 572; Arnott in Edinb. Encyc., 129.

Gen. Char. of the Order. Flowers semi-sexual. Sepals hypogynous imbricated scales, the innermost of which are sometimes petaloid. Stamens equal in number to the inner sepals, and alternate with them; anthers roundish, 2-celled, the cells distinct, bursting longitudinally. Ovary superior, seated in a fleshy disk, 3-6- or 9-celled; ovules solitary, ascending. Style 1; stigma radiating, the number of its rays corresponding with the cells of the ovary. Fruit fleshy, seated in the persistent calyx, 3-6- or 9-celled; the coating of the cells bony. Seeds solitary, ascending; embryo taper, in the axis of fleshy watery albumen; radicle inferior. Small shrubs, with heath-like evergreen leaves, without stipules, and with minute flowers in their axils. A very small group, comprising a few species from North America, the south of Europe, and the Straits of Magellan. (*Lindl. Nat. Syst. of Bot.*, p. 117.) The fruit is in all a small berry.

There are only three genera, which are as follows:—

EMPETRUM L. Calyx 3-leaved, coriaceous, with 6 imbricated scales at the base. Petals 3. Stamens 3. Stigma 6—9-cleft. Berry depressed, 6—9-stoned. Small, branchy, procumbent shrubs; natives of the north of Europe and the Straits of Magellan. Leaves alternate, linear tongue-shaped, obtuse; flat above, convex and marked with a membranaceous line beneath; dark green, shining. Flowers axillary, solitary, sessile, dark red. Berries black or red. (*D. Don in Edinb. New Phil. Journ.*)

COREMA D. Don. Calyx 3-leaved, membranaceous, naked at the base. Petals 3. Stamens 3. Stigma 6-cleft. Berry globose, 3-stoned. A small, erect, branchy, rigid shrub, covered with resinous dots; a native of the south of Europe. Leaves scattered, linear, obtuse, spreading; flattish above, revolute on the margin. Flowers in terminal heads, sessile, situated on a hairy disk; white, large. Heads having villous scales. Berries white. (*D. Don in Edinb. New Phil. Journ.*)

CERATIOLA Rich. Calyx 2-leaved, membranaceous, with 4 scales at the base. Petals 2, converging into a tube. Stamens 2. Stigma 6-cleft. Berry globose, 2-stoned. A small, upright, branchy, rigid shrub; a native of North America. Branches straight, simple. Leaves alternate, spreading, needle-shaped, obtuse, glabrous, shining, green; marked beneath with a narrow furrow; slightly canaliculate above; about $\frac{1}{2}$ in. long; sometimes crowded, as if verticillate. Flowers axillary, sessile, numerous (2—4), rarely solitary; sometimes (like the leaves) verticillate. Berries red,? (*D. Don in Edinb. New Phil. Journ.*)

GENUS I.

**EMPETRUM L. THE CROWBERRY. Lin. Syst. Dic'cia Triandra.**

Identification. Lin. Gen., 515; Juss., 162; Fl. Br., 1072; Tourn., t. 421; Lamb., t. 303, Gaertn., t. 106.

Derivation. From *en*, upon, and *petros*, a rock; in allusion to the place of growth.

Description, &c. Small evergreen heath-like shrubs, natives of Europe and South America. Propagated by cuttings or seeds, and thriving best in peat soil.

1. *E. NIGRUM* L. The black Crowberry, or *Crakeberry*.

Identification. Lin. Sp. Pl., 1450.; Willd. Sp. Pl., 4. p. 713.; Fl. Br., 1072.; Eng. Bot., t. 526.; Hook. Scot., 287.; Mill. Illust., t. 86.; Fl. Dan., t. 975.; Dicks. H. Sicc., fasc., 2. 10.; Eng. Fl., 4. p. 233.; Mackay Fl. Hibern., p. 238.; Hook. Br. Fl., p. 431.; Lindl. Synop., p. 224.; Lodd. Cat., ed. 1836.

Synonymes. *E. montanum fructu nigro Raii Syn., 444.; E. No. 1605., Hall. Helv., 2. p. 279.; Erica Matth. Valgr., 1. p. 139.; Erica bacifera Com. Epit., p. 77., Cus. Pan., p. 49., Dalech. Hist., p. 188., Bauh. Hist., 1. p. 596.; E. coccifera procumbens Ger. Emac., p. 1583.; E. Còris folio undecima Cus. Hist., 1. p. 45.*

Engravings. Eng. Bot., t. 526.; Mill. Illust., t. 86.; Fl. Dan., t. 975.; our *fig.* 2375. to our usual scale; and *fig.* 2376. of the natural size.

Spec. Char., &c. Leaves linear-oblong. Berries black and clustered. (*Hook.*) A procumbent shrub, a native of Britain.

Variety.

1. *E. n. 2 scoticum* Hook. Br. Fl., p. 431., is somewhat smaller than the species.

Description, &c. A small, procumbent, much-branched shrub; the outer bark of which is deciduous and brown, but the inner bark is yellow. The branches are rough with the remains of the petioles of the fallen leaves. The leaves are in fours, somewhat 3-cornered, with a white linear keel, and petioled; and they have their margins so much recurved as to meet behind. The flowers are axillary towards the summits of the branches, small, and purplish, with a whitish calyx. The berries are of the size and colour of juniper berries, but become of a brownish black when ripe. They are marked at top with a small round hole, and protected at bottom by the persistent calyx. The flesh is rather firm, and of a pale green, except in the centre, where it is purplish. The receptacle is columnar, and slender; and from 6 to 9 bony pale-coloured seeds are fixed round it in a ring, and attached to it a little above the base. This species is a native of the north of Europe, generally in elevated situations, both on dry and barren, and on moorish or boggy, soils. It is found in moors, from the Baltic to the Eastern Ocean, in Kamtschatka, and in the islands towards America. According to Linnæus, it will live on the mountains of Lapland, where other plants perish with cold. It is found in Warwickshire, Staffordshire, Derbyshire, and the northern counties of England, and abundantly in Scotland. The Scotch Highlanders and the Russian peasants eat the berries, which are esteemed antiscorbutic and diuretic. Grouse and heathcocks feed on them; and, boiled in alum water, they afford a dark purple dye. Linnæus mentions that the Laplanders use them for dyeing otter and sable skins black. Cattle do not browse on this shrub. The crowberry is the badge of the clan M'Lean. The *Empetrum nigrum* thrives very well in gardens, but it requires a moist boggy soil, and a shady situation. The seeds remain a year in the ground before they vegetate, and the plants are very slow in their growth. (*Mart. Mill., and Hook. Brit. Fl.*)



2. *E. RUBRUM* L. The red-fruited Crowberry.

Identification. Willd. Sp. Pl., 4. p. 713.; Lindl. Bot. Reg., t. 1783.

Synonymy. Cranberry of Staten Island.

Engravings. Bot. Reg., t. 1783.; our *fig.* 2377. to our usual scale; and *fig.* 2376. of the natural size.

Spec. Char. Leaves and branches with woolly margins. Berries red.
(Lindl.) An evergreen procumbent shrub, with brownish purple flowers, and red fruit. A native of the southern point of South America, where it is found "along the sandy coast, spreading over the stones, but especially thriving at the back of the low sand hills, by which the shore is often skirted." (*Bot. Mag.*) It is also found near Concepcion. It was introduced in 1833, by Mr. Low of the Clapton Nursery, and flowered there in July, 1835. "According to Gaudichaud, the red berries are pleasant to eat." It grows freely in peat, and is quite hardy.



2377



2378

GENUS II.



COREMA D. Don. THE COREMA Lin. Syst. Diœ'cia Triândria.

Identification. D. Don in New Edin. Phil. Journ.; Lindl. in Nat. Syst. of Bot.

Synonymy. *E'mpetrum*, in part, L.

Derivation. From *korēma*, a broom; in allusion to the habit of the plant.

Description, &c. An upright shrub, a native of Portugal; closely allied to *E'mpetrum*, and requiring the same soil and culture in British gardens.

= 1. C. A'LEBA D. Don. The white-berried Corema.

Identification. D. Don in New Edin. Phil. Journ.

Synonymy. *E'mpetrum album* Lin. Sp., 1450.; *Willd. Sp. Pl.*, 4. p. 712.; *Gertn. Fruct.*, 2. 107.; *Mart. Mill.*, No. 1., *Art. Hort. Kew.*, ed. 2., 5. p. 363.; *E. lusitanicum*, &c., *Tournef. Inst.*, 579.; *Erica erecta*, &c., *Bauh. Pin.*; the white-berried Heath, Portugal Crakeberry.

Spec. Char., &c. Stem erect. Branches pubescent. Leaves linear, with revolute margins; somewhat scabrous above. (*Willd.*) A shrub, a native of Portugal. Introduced in 1774.

Description, &c. An upright-growing low shrub, very much branched, rigid, sprinkled with resinous dots. Leaves scattered in all directions, linear, obtuse, spreading; flattish above, revolute on the margin. Flowers terminal, grouped, sessile; imposed upon a hairy disk, white, and larger than those of *E'mpetrum*. Groups bracteolated with villose scales. Berry white. Introduced from Portugal, in 1774, by Messrs. Kennedy and Lee. Culture the same as for *E'mpetrum nigrum*.

GENUS III.



CERATIOLA Michx. THE CERATIOLA Lin. Syst. Monœ'cia Diândria.

Identification. Michx. Fl. Bor. Amer., 2. p. 222.; Lindl. in Nat. Syst. of Botany, ed. 2.

Derivation. From *keration*, a little horn; in allusion to the shape of the stigma.

Engravings. *Fursh.*, l. t. 13.; *Bot. Mag.*, t. 2758.; our *fig.* 2380. to our usual scale; and *fig.* 2379. of the natural size.

Description, &c. A small, heath-like, evergreen shrub; a native of North America; grown, in British gardens, in peat soil, and propagated by cuttings.

■ 1. C. ERICOIDES. The Erica-like Ceratiola.

Identification. Michx. Fl. Bor. Amer., 2. p. 222.; Bot. Mag., t. 2758; Willd. Sp. Pl., 4. p. 712.; Pursh Fl. Amer. Sept., 1. t. 13.

Spec. Char., &c. Flowers in the axils of the upper leaves, solitary, except a small abortive one by the side of the principal flower.

Description, &c. An upright much branched shrub, greatly resembling a heath, and varying from 2 ft. to 8 ft. high. Branches subverticillate, erect, and marked with the remains of the petioles of the fallen leaves. The upper and younger branches retain their leaves, which are slightly tomentose. Leaves in whorls of 4, spreading, long, linear, rigid, acerose. Flowers very small. A native of South Carolina, on the Edisto River, where it covers a space 300 or 400 yards in width, and two or three miles long, which appears to have been a sand-bank formed by some of the ancient freshets of the river, and on which only a few stunted oaks (*Q. Catesbæi* and *Q. nigra*) are found intermingled with it. According to Pursh, it is also found in the gravelly dry soil of Georgia and Florida; and, in great plenty, on the islands at the mouth of St. Mary's River. It was introduced in 1826.



CHAP. CXV.

OF THE HARDY LIGNEOUS PLANTS BELONGING TO THE ORDER SMILACEÆ.



Identification. Lindl. Nat. Syst. Bot., p. 359.

Synonymes. Liliacæ, in part, *Juss. Gen.*, 42.; Sarméntacæ, in part, *Nees Von Esenbeck Gen. Pl.*;

Smilacæ, in part, *R. Brown Prodr.*, p. 222.; *Lindl. Synops.*, p. 270.; *Bart. Ord. Nat.*, p. 52.

Derivation. From *Smilax*, a beautiful youth, fabled to have been changed into this plant (see *Ovid Met.*); or, according to others, from *smilæ*, a scraper, from the roughness of the stems of most of the species.

General Characteristics, &c. Monocotyledonous. Flowers hermaphrodite or diœcious. Calyx and corolla confounded, inferior, 6-parted. Stamens 6, inserted into the perianth near the base; seldom hypogynous. Ovary 3-celled; the cells 1- or many-seeded. Style trifid. Stigmas 3. Fruit a roundish berry. Albumen between fleshy and cartilaginous. Embryo usually distant from the hilum. (*Lindl. in Nat. Syst. of Bot.*) Small climbing shrubs, with woody stems, and reticulated leaves, though they are considered as monocotyledonous plants. This order is nearly allied to Liliacæ, of which it was formerly considered to form a part. The plants composing it are found in small quantities in most parts of the world; but the only ligneous plants which it contains belong to the genus *Smilax*.

GENUS I.

SMILAX L. THE SMILAX. *Lin. Syst. Diss'cia Hexándria.*

Identification. Lin. Gen., No. 1190.; Reich., No. 1225.; Schreb., No. 1522.; Tournef., t. 421.; Juss., 42.; Gussn., t. 16.; Mart. MB.

Description, &c. Evergreen shrubs, climbing by means of their tendrils, with stems that are generally prickly. Leaves with veiny disks. The tendrils are intrapetiolar stipules. Natives of Europe and North America. In British gardens, they grow in sandy loam, and are readily propagated by division of the root. They are not showy, but they are interesting from their twining character, as being generally evergreens, and as being some of the few hardy ligneous plants which belong to the grand division of vegetables *Mesocotyledonæ*. The species being little cultivated, and many of those which are being seldom seen in flower, are very imperfectly known by cultivators. The greatest number of species are at Messrs. Loddiges's, in the Botanic Garden at Twickenham, and at Kew. Plants, in the London nurseries, are from 2s. to 5s. each, according to the scarcity of the species.

The following fungi are found upon the North American species:—*Sphaeria smilacicola* Schwein, *S. erumpens* Schwein, *Rhytisma Smilacis* Schwein, chiefly on *S. laurifolia* and *S. rotundifolia*; *Hysterium Smilacis* Schwein, on *S. rotundifolia*; *Cladosporium Smilacis* Fr., *Uredo Smilacis* Schwein, *Æcidium Smilacis* Schwein. — *M. J. B.*

§ i. *Stems prickly and angular.*1. *S. a'SPERA* L. The rough Smilax.

Identification. Lin. Sp., 1458.; Gron. Orient., 315.; Scop. Carn., No. 1261.; Gouss. Hort. Monsp., 505.; Vill. Dauph., 3. p. 272.; Mart. Mill., No. 1.; Lodd. Cat., ed. 1836.

Synonymes. Rough Bindweed; Smilax, Fr. and Ger.

Engravings. Schk. Han., 3. 322.; and our Ag. 2381.

Spec. Char., &c. Stem prickly, angular; leaves toothed and prickly, cordate; 9-nerved. (*Willd.*) A native of the south of Europe, Asia Minor, and Africa. Cultivated in the Oxford Botanic Garden in 1648.

Variety.

1. *S. a. 2 auriculata* Ait. Hort. Kew., ed. iii. p. 401., has the leaves ear-shaped at the base.

Description, &c. An evergreen climbing shrub, with numerous slender angular stems, armed with short crooked spines, and having tendrils on their sides, by which they fasten themselves to any neighbouring object for support. The roots are thick and fleshy, "spreading wide, and striking deep." The leaves are rather large, and heart-shaped; somewhat stiff, of a dark green, marked with 5 longitudinal nerves, and with a few short reddish spines round their margins. The flowers are axillary, on short branches, small and whitish; and those on the female plants are succeeded by berries, which are sometimes red and sometimes black. It is a native of the south of France, Italy, Spain, and Carniola; and it has also been found near Tripoli, and between Rama and Joppa. It is stated, in Martyn's *Miller*, to have been introduced by Mr. John Tradescant, in 1656; but the *Hortus Kewensis* informs us that it was cultivated in the Oxford Botanic Garden before 1648. The roots are sometimes sold by the druggists



2381

of the south of Europe for those of *S. Sarsaparilla*; and they possess nearly the same qualities, but in an inferior degree: they are also larger, and more porous. In British gardens, it is commonly trained against a wall; but it will also attach itself to rough stakes, though it seldom flowers when so treated. It will attain the height of about 6 ft.

1. *S. a. 2 mauritànica*, *S. mauritànica* Poir., was introduced in 1820, and there are plants in the Horticultural Society's Garden,

1. 2. *S. EXCELSA* L. The tall Smilax.

Identification. Lin. Sp., 1458; Willd. Sp. Pl., 4. p. 774; Mart. Mill., No. 2; Alt. Hort. Kew. ed. 2., 5. p. 387; Lodd. Cat., ed. 1836.
Synonymes. *S. orientalis*, &c., *Tavern. Cor.*, 45., *Bux. Cent.*, 1. 18; *S. áspera* Alp. *Ægypt.*, ed. 2., 140.
Engravings. *Bux. Cent.*, 1. t. 37.; Alp. *Ægypt.*, ed. 2., t. 141.; and our *fig.* 2382.

Spec. Char., &c. Stem prickly, angular. Leaves unarmed, cordate, 9-nerved. (*Willd.*) A climbing shrub, a native of Syria; cultivated before 1739, by Miller; and flowering in August and September.

Description, &c. Stems 4-cornered, and prickly; mounting to the tops of tall trees, by means of their clasping tendrils. Leaves 2 in. long, and 1½ in. broad at the base, having 5 longitudinal nerves, but no spines on their margins. The flowers and fruit are like those of *S. áspera*. The roots resemble and possess the same qualities as those of *S. áspera*, but are inferior to those of *S. Sarsaparilla*. It is a native of Syria, whence it was introduced before 1739, and was at first thought tender; there are, however, plants in Messrs. Loddiges's arboretum, in the Horticultural Society's Garden, and other places, which appear quite hardy.



1. 3. *S. S. RU'BENS* Wats. The red-tendriled Smilax.

Identification. Watson Dend. Brit., t. 108.; Loud. Hort. Brit. Engravings. Dend. Brit., t. 108.; and our *fig.* 2383.

Spec. Char., &c. Stem angular, prickly. Leaves ovate-subcordate, rather obtuse, mucronate, coriaceous, 5-nerved; margin mucronate-denticulate near the base. (*Wats.*) A handsome climbing shrub, with the leaves edged with short prickles, and brown stipules, with a red spiral tendril on each side. A native of North America, in woods and by streams. There are plants in the Botanic Garden, Twickenham, where one flowered in July, 1821. This is a most ornamental species, from the contrast between the colour of its leaves and that of its tendrils; it is, however, in very few collections.



1. 4. *S. SARSAPARILLA* L. The medicinal Smilax, or Sarsaparilla.

Identification. Lin. Sp., 1459; Willd. Sp. Pl., 4. 775; Alt. Hort. Kew., ed. 2., 5. p. 388.; Mart. Mill., No. 4.; Pursh Fl. Amer. Sept., 1. p. 249.; Lodd. Cat., ed. 1836.
Synonymes. *S. áspera* peruviana *Sarsaparilla* Rauh. Pin., 236.; Rail Hist., 656.; *S. peruviana* *Sarsaparilla* Gr. Emac., 289.; *S. áspera* peruviana *Park. Theat.*, p. 173.; *S. glauca* *Michx.*, 2. p. 257.; *Walt. Fl. Car.*, 245.; the glaucous-leaved Smilax.
Derivation. *Sarsaparilla* is compounded of two Spanish words; viz., *zarza*, red, and *parilla*, a little vine.
Engravings. *Park. Theat.*, t. 174. f. 3.; *Dend. Brit.*, t. 111.; and our *fig.* 2384.

Spec. Char., &c. Stem prickly, angular. Leaves unarmed, ovate-lanceolate, ending in a long sharp point; 5-nerved, glaucous beneath. (*Willd.*) A

native of North and South America. Introduced before 1664, and flowering in July and August.

Description, &c. Stems shrubby, long, slender, and climbing. Roots divided into several long slender branches, which are somewhat thicker than a goose-quill, straight, brown on their exterior, but white internally, and from 3 ft. to 4 ft. long. Leaves alternate and pointed, with long tendrils at the base. Flowers lateral, usually three or four together on one common peduncle. A native of Peru, Brazil, Mexico, and Virginia. It is included in Evelyn's *Kalendar*, as having been in cultivation before 1664; but, according to Plukenet, it was first brought to England by Mr. Foster, in 1691. Caspar Bauhin informs us that the root was introduced into Spain from Mexico, as a medicine, in 1573; but Monarda asserts that it was known there twenty or thirty years previously. Sarsaparilla, on its first introduction, was considered as a specific against numerous disorders; but it has since gradually fallen into disuse. It is, however, still occasionally employed in rheumatic complaints, scrofula, and all cutaneous diseases, "where an acrimony of the fluids prevails." The plant is at Messrs. Loddiges's, and in the Botanic Garden, Twickenham; but it does not grow so freely as *S. áspera*, and is somewhat tender.



1. 5. *S. HASTATA* Willd. The spear-shaped Smilax.

Identification. Willd. Sp. Pl., 4. p. 782.; Pursh Fl. Amer. Sept., 1. p. 240.; Loud. Cat., ed. 1830.
Synonymes. *S. Edna* n. s. Michx. Fl. Amer., 2. p. 237.; Walt. Fl. Car., 245.; *S. áspera* var. Linn. Encyc., 6. p. 465.
Engraving. Pluk. Alm., t. III. f. 8.

Spec. Char. Stem subarmed. Leaves lanceolate, acuminate; auriculate, or spear-shaped, at the base; ciliated or prickly on the margin; 3—5 nerves. Berries round. (Willd.)
A native of the sea coast of Carolina and Florida. Introduced in 1820.

Variety.

1. *S. h. 2 lanceolata* Pursh Fl. Amer. Sept., i. p. 240.;
S. lanceolata Walt. Fl. Car., 245.; ? *S. longifolia*
Wats. Dend. Brit., t. 110.; and our fig. 2385.; *S.*
Watsoni Sweet; has the leaves longer and narrower
than the species, and not spear-shaped at the
base.

Description, &c. A weak climbing shrub, with subangular, green, smooth branches, with horizontal, acute, short spines. Leaves alternate, glabrous, and of the same colour on both sides; and with long spiral tendrils. There are plants at Messrs. Loddiges's.



1. 6. *S. WALTERII* Pursh. Walter's Smilax.

Identification. Pursh Fl. Amer. Sept., 1. p. 240.
Synonymes. *S. China* Walt. Fl. Car., p. 245.

Spec. Char., &c. Stem prickly. Leaves ovate-cordate, smooth, 3-nerved. Berries acuminate. (Pursh.) A native of the low sandy parts of Virginia and Carolina, on the river sides. It is rather ornamental, from the shape of its leaves, and its having red berries. It was supposed by Walter to be *S. China*; but it differs in its leaves having only 3 nerves, and in some other particulars. It is rather tender. There are plants in the Horticultural Society's Garden, against the conservative wall.

§ ii. Stem prickly, round.

E. 7. *S. CHINA* L. The Chinese Smilax.

Identification. Lin. Sp. Pl., 1459; Willd. Sp. Pl., 4. p. 778; Gron. Orient., 317.; Brown Jam., 359.; Thunb. Jap., 152.; Lour. Coch., 622.; Mart. Mill., No. 6.; Alt. Hort. Kew., ed. 2., 6. p. 368.
Synonymæ. *China* radix *Bauh. Pin.*, 896., *Park. Theat.*, 1578., *Hort. Hist.*, 657.; *C. vulgaris officinarum Ger. Emac.*, 1618.; *Smilax aspera minor Plum. Ic.*, 183.; *Sankira*, vulgo *Quaquara*, &c., *Kempfer Amam. Es.*, p. 781.
Engravings. Gmel. Il., 3. t. 6.; *Blackw.*, t. 433.; *Kempf. Amom.*, t. 782.; *Pluk. Amal.*, t. 408. f. 1.

Spec. Char., &c. Stem round, with a few spines; leaves roundish-ovate, with acute points, 5-nerved. (*Willd.*) This is a climbing shrub, rising in its native country, to the height of 20 ft., with thick leaves, long tendrils, and red berries. The root is very large, fleshy, and reddish: it is used for food, in some parts of China, instead of rice; and is considered extremely nourishing. It is a native of China and Japan, and also of Jamaica; and of Carthagea, in New Spain, whence Miller received it before 1759. Brown found it in abundance in Jamaica, where the roots are used to feed hogs. When first brought to England, it was cultivated in the stove; it was afterwards transferred to the green-house; and, in 1831, was planted out against a wall in the Horticultural Society's Garden, where it has remained uninjured ever since.

E. 8. *S. ROTUNDIFOLIA* L. The round-leaved Smilax.

Identification. Lin. Sp., 1460.; Willd. Sp. Pl., 4. p. 779.; Mart. Mill., 7.; Alt. Hort. Kew., ed. 2., 5. p. 338.; Pursh Fl. Amer. Sept., 2. p. 250.; Lodd. Cat., ed. 1836.

Spec. Char., &c. Stem round, somewhat prickly. Leaves roundish-ovate, or cordate, very smooth, 5-nerved. Berries spherical. (*Willd.*) A climbing shrub, ascending to the height of about 6 ft., with flexuose stems, and a very few straight prickles. Leaves naked, 5-nerved, wider than long, acute; on short petioles, with 2 filiform tendrils. A native of North America, where, according to Pursh, it is common in hedgerows from Canada to Carolina. It was found in Canada by Kalm, and sent by him to England, where it was first cultivated by Archibald Duke of Argyll, in 1760. There are plants at Messrs. Loddiges's.

E. 9. *S. LAURIFOLIA* L. The Laurel-leaved Smilax.

Identification. Lin. Sp. Pl., 1460.; Willd. Sp. Pl., 4. p. 779.; Mart. Mill., No. 8.; Alt. Hort. Kew., ed. 2., 5. p. 338.; Pursh Fl. Amer. Sept., 1. p. 250.; Lodd. Cat., ed. 1836.
Synonymæ. *S. altera*, &c., *Plum. Ic.*; *S. laurina*, &c., *Calceol. Car.*, 1. t. 15.
Engravings. *Cat. Car.*, 1. t. 15.; *Plum. Ic.*

Spec. Char., &c. Stems round; main stem prickly. Branches unarmed. Leaves coriaceous, elliptic, 3-nerved. Umbels on very short peduncles. (*Willd.*) A very handsome climbing shrub, rising 10 ft. or 12 ft. high, with smooth coriaceous leaves (which, Linnæus says, are thicker than those of any of the other species of Smilax), and black berries. It is a native of North America, in sandy boggy woods, from New Jersey to Georgia, and was in cultivation in England, by Miller, before 1739. There are plants at Messrs. Loddiges's.

E. 10. *S. TAMNÖIDES* L. The black Bryony-like Smilax.

Identification. Lin. Sp. Pl., 1460.; Willd. Sp. Pl., 4. p. 780.; Mart. Mill., 9.; Pursh Fl. Amer. Sept., 1. p. 251.; Lodd. Cat., ed. 1836.
Synonymæ. *S. Bryonia nigra*, &c., *Catesb. C. r.*, 1. t. 52.
Engraving. *Cat. Car.*, 1. t. 53.

Spec. Char., &c. Stem round and prickly. Leaves unarmed, cordate-oblong, 7-nerved. (*Willd.*) A climbing evergreen shrub, rather suffrutescent than woody; with taper stems, and leaves 4 in. long, and 2½ in. broad at their base, having 7 longitudinal veins. The flowers come out in long loose bunches from the sides of the stalks, and the berries are black. (*Mill.*) A native of North America, in sandy wet woods and bogs in Virginia and Carolina. It was cultivated by Miller before 1739, and flowers in June

and July. A very handsome species, of which there are plants at Messrs. Loddiges's.

Æ 11. *S. CADUCA* L. The deciduous Smilax.

Identification. Lin. Sp. Pl., 1460.; Willd. Sp. Pl., 4. p. 780.; Mart. MIL., No. 10.; Ait. Hort. Kew., ed. 2., 5. p. 389.; Pursh Fl. Amer. Sept., 1. p. 250.; Lodd. Cat., ed. 1836.

Spec. Char., &c. Stem round, prickly. Leaves unarmed, ovate, 3-nerved. (Willd.) A deciduous climber, with a flexible stem, armed with a few short spines, black at the tip. According to Miller, he received this plant from Carthage, in New Spain; and he describes it as rising to the height of 30 ft., and having thick heart-shaped leaves. In the *Hortus Kewensis*, it is said to be a native of Canada, and introduced before 1759; but Martyn says that it was introduced in 1775, by Mr. William Young. A species was found in China by Loureiro, which he calls *S. caduca*; and the description of it agrees with that of Linnæus; but Professor Martyn appears to think it improbable that the same species should be a native of three climates so different as those of Canada, South America, and China. There are plants of *S. caduca* at Messrs. Loddiges's.

§ iii. *Stalks unarmed, 4-angled.*

Æ 12. *S. BONA NOX* L. The Bona nox, or ciliated, Smilax.

Identification. Lin. Sp. Pl., 1460.; Willd. Sp. Pl., 4. p. 781.; Mart. MIL., No. 11.; Ait. Hort. Kew., ed. 2., 5. p. 389.; Pursh Fl. Amer. Sept., 1. p. 249.

Synonyma. *S. aspera* India occidentalis *Benth. Pta.*; *S. foliis latis*, *Gr.*, *Pluk. Phyt.*, 348.; *S. variegata* *Willd. Fl. Car.*, 244.
Engraving. *Fluk. Phyt.*, t. 111. f. 1.

Spec. Char., &c. Stalks unarmed, angular. Leaves cordate-ovate, with an acute point, ciliated, 7-nerved. (Willd.) A native of North America, in the woods of Carolina and Georgia; cultivated by Miller, according to the *Hortus Kewensis*, before 1739, and flowering in June and July. *Plukenet* mentions a variety, which he has figured under the name of *S. B. caroliniana* *Pluk. Phyt.* t. 111. f. 3. There are plants in the Horticultural Society's Garden.

Æ 13. *S. LATIFOLIA* R. Br. The broad-leaved Smilax.

Identification. *Brown Prod.*, 293.; Ait. Hort. Kew., ed. 2., 5. p. 390.

Spec. Char. &c. Stem unarmed, angular. Leaves ovate; base half-heart-shaped or obtuse, glabrous, 5-nerved; petioles bearing tendrils. (*Brown*) A native of New Holland. Introduced by Sir Joseph Banks, in 1791. It was first placed in the green-house, but has since been found to stand out at Kew.

Æ 14. *S. QUADRANGULARIS* Muhl. The four-angled Smilax.

Identification. Muhl. in *Flora Dan.*; Willd. Sp. Pl., 4. p. 5775.; *Wats.* in *Dend. Brit.*, t. 103.; *Pursh Fl. Amer. Sept.*, 1. p. 249.
Engraving. *Dend. Brit.*, t. 103.; and our fig. 2386.

Spec. Char., &c. Stem prickly, tetragonous. Leaves unarmed, ovate, acute, 5-nerved. (Willd.) A native of North America. Introduced in 1812, and flowering in June and July.

Description, &c. A weak twining shrub, with 4-angled glabrous branches, covered with pale spots. Leaves glabrous, alternate, deltoid-orbicular, with an entire margin; subcordate at the base, and obtusely acuminate at the point, with a short, glabrous, grooved, and reddish petiole. Tendrils 2, from a sheath at the base of each petiole; long, filiform, and glabrous. The berries are black. A native of North America, in woods, on the edges of ponds, from Pennsylvania to Carolina. It was introduced in 1812, and is occasionally to be met with in collections. There are plants in the Botanic Garden, Twickenham.



2386

§iv. *Stems unarmed, round.*15. *S. LANCEOLATA* L. The lanceolate-leaved Smilax.

Identification. Lin. Sp. Pl., 1460.; Willd. Sp. Pl., 4. p. 783.; Lour. Coch., 683.; Ait. Hort. Kew., ed. 2., 5. p. 680.; Pursh Fl. Amer. Sept., 1. p. 250.

Synonymæ. *S. non spinosa*, &c., *Cast. Car.*

Engraving. Catesb. Car., 2. t. 84.

Spec. Char., &c. Stem unarmed, round. Leaves unarmed, lanceolate. (*Willd.*) A climbing shrub, with a short, very branchy stem, and smooth, entire, 3-nerved leaves, and red berries. Catesby found this species in Carolina, hanging from the branches of lofty trees, to which it had attached itself. The leaves are long, narrowed at both ends, thick, stiff, and shining, with a very conspicuous rib down the middle. They are alternate at very considerable distances. The flowers, which are of a greenish white, are produced at the ends of the branches, in small tufts; and are succeeded by globular, mucilaginous, red berries, each containing one very hard round stone. These berries serve as food for birds. It is a native of Virginia, Carolina, and Cochin-China; in which last country it was discovered by Loureiro; and it was introduced from America in 1785, by Mr. William Young.

16. *S. VIRGINIANA* Mill. The Virginian Smilax.

Identification. Mill. Dict., No. 9.; Mart. Mill., No. 90.; Lodd. Cat., ed. 1836.

Engraving. Fluk. Phyt., t. 110. f. 4.

Spec. Char., &c. Stem prickly, angular. Leaves lanceolate, unarmed, acuminate. (*Mill.*) This species is somewhat tender; but there are plants in the open ground at Messrs. Loddiges's.

17. *S. PUBERA* Willd. The downy Smilax.

Identification. Willd. Sp. Pl., 4.; Ait. Hort. Kew., ed. 2., 5. p. 390.; Pursh Fl. Amer. Sept., 1. p. 250.

Synonymæ. *S. pumila* Walt. *Car.*, 944.

Spec. Char., &c. Stem unarmed, round. Leaves oblong, acute, cordate, indistinctly 5-nerved; soft and pubescent beneath. Berries oblong, acute. (*Willd.*) A climbing shrub, a native of North America. Introduced in 1806, by Mr. John Lyon, who found it in shady woods in Carolina and Georgia. According to Walter, the berries are white. We have not seen the plant.

App. i. *Kinds of Smilax which are either not introduced, or of which we have not seen the Plants.*

S. ovata Pursh Fl. Amer. Sept., 1. p. 249., has the stem subarmed; the leaves smooth, ovate, 3-nerved, and very shining on both sides; berries black. A native of Georgia, near Savannah, flowering in July.

S. alba Pursh, l. c., p. 250. Stem subarmed, slightly angular; leaves 3-nerved, lanceolate, coriaceous, glabrous; berries white. Found by Walter, in sandy ground on the edge of rivulets, in Carolina; flowering in June.

S. paniculata Pursh, l. c., p. 251. Stem prickly; leaves ovate, saddle-shaped, acuminate, 3-nerved; smooth and shining on both sides. Found by Pursh, in sandy woods, from New Jersey to Carolina; flowering in July.

S. nigra W. and *S. catalanica* Poir. are natives of Spain, from which country they were brought to England in 1817. The first is probably a black-berried variety of *S. aspera*.

S. horrida Desf. is a native of North America, introduced in 1820.

S. glauca Walt. is a native of North America, introduced in 1811; and is probably a variety of *S. sarsaparilla*.

S. alpinus W. is a native of Greece, introduced in 1820.

CHAP. CXVI.

OF THE HARDY AND HALF-HARDY LIGNEOUS PLANTS BELONGING TO THE ORDER LILIA'CEÆ.

THE only genera containing hardy ligneous plants, in the order Liliacæ, belong to the section *Asparagææ*, and are as follows:—

ASPARAGUS L. Corolla six-parted; erect; the three inner petals reflexed at the tip. Berries 3-celled, 2-seeded.—Suffruticose plants, climbing and erect. Natives of Europe, Asia, and Africa.

Ruscus L. Flowers unisexual.—Male. Calyx 6 sepals. Corolla none. Nectary central, oval, and perforated at the apex.—Female. Calyx, corolla, and nectary like those of the male. Style 1. Berry 3-celled. Seeds 2.—Evergreen shrubs, with inconspicuous flowers, which are borne on the leaves. Natives of Europe and Africa.

Fuchsia L. Corolla bell-shaped and spreading. Style none. Capsules 3-celled.—Aloe-like shrubs, with very long, lanceolate, sharp-pointed leaves, and tall spikes of bell-shaped flowers. Natives of North and South America.

GENUS I.

**ASPARAGUS L. THE ASPARAGUS. Lin. Syst. Hexándria; Monogýnia.**

Identification. Lin. Gen., No. 464; Reich., 457; Schreb., 573; Tournef., 154; Gærtn., 16; Jacq., 41; Ait. Hort. Kew., ed. 2, p. 273; Mart. Mill.

Synonymes. Sarméntaceæ, part of, *Juss.*, *Necesse von Esenbeck*; *Asperges*, Fr.; *Spergula*, Ger.; *Coral-cruyt*; Dutch; *Sperage*, *Old English*; *Corruca*, Span.

Derivation. According to some, from *a*, not, and *sparassô*, to tear; from the prickles not being very strong; or from *asper*, rough, and *gustus*, a taste; in allusion to the common asparagus being rough, and yet eaten as food. Gerard says that the Latins used the word *asparagi* to signify the young shoots or sprouts of any plant; and that this was applied to asparagus, because it is only the young shoots of the common asparagus that are eaten. *Coral-cruyt* signifies coral-weed, from the coral-like appearance of the berries.

Description, &c. Slender-stemmed suffruticose plants; natives of Europe and Africa, not remarkable for beauty. All the species grow freely in deep dry sandy soil, at the base of a wall with a southern exposure; and they are propagated by division of the root. They are seldom met with, except in botanic gardens.

1. *A. SCANDENS* Willd. The climbing Asparagus.

Identification. Willd. Sp. Pl., 2 p. 152; Ait. Hort. Kew., ed. 2, p. 273.

Spec. Char., &c. Stem unarmed, twining. Leaves lanceolate and sickle-shaped. (Willd.) A suffruticose, climbing, evergreen shrub; a native of the Cape of Good Hope. Introduced by Mr. Fr. Masson, in 1795. There is a plant against the conservative wall in the Horticultural Society's Garden, which was planted out in 1831.

2. *A. ALBUS* L. The white Asparagus.

Identification. Lin. Sp. Pl., 449; Reich., 2 p. 107; Raf. Hist., 634, 635; Mart. Mill., No. 7; Ait. Hort. Kew., 2 p. 273; Lodd. Cat., 1836.

Synonymes. *A. spinosus*, &c., *Park. Theat.*, p. 455; *A. sylvestris*, &c., *Ger. Emac.*, p. 231; *Corruca tertia* *Clus. Hist.*, 2 p. 178; *Wild Thong Sperage*.

Engravings. *Park. Theat.*, p. 455. f. 5.; *Ger. Emac.*, III. t. 8.

Spec. Char., &c. Prickles solitary. Branches angular, flexuose. Leaves fascicled, triquetrous, awnless. (Willd.) Stems shrubby, 3 ft. or 4 ft. high, with very white bark, and armed with strong thorns, which are single, and come out just below each tuft of leaves. The stems continue several years, and put out many branches, with short narrow leaves; and these continue green all the winter, if the plants are screened from severe frost. It is a native of Spain and Portugal, but has been long in cultivation in British gardens. According to Gerard, it is mentioned by Belon in his *Singularitez*, &c., lib. i. cap. 18., as growing in Candy; that is, Candia. Parkinson, in 1600, first mentions its being cultivated in Britain. He calls it the "unparag" with cruell sharpe thornes," and says that it grows "in rough uneven places, very plentiful about Lishborne, in the common wayes, and by the River Thames, and in many other places, both in Spain and Portugal, and in Candy like

wise; but it will hardly endure our cold climate." There are plants at Messrs. Loddiges's

3. *A. APHYLLUS*, The leafless, or prickled Asparagus.

Identification. Lin. Sp. Pl. 450; Reich., 2. 70; Mart. Mill. No. 10; Ait. Hort. Kew., No. 11.
Synonymes. *Corrêda* altera Clus. *Elat.*, 2. p. 178; *A. petraea*, Prickly Roche Asparagus, *Park.*
Flora. *Flora* 9000.

Spec. Char., &c. Stem regular, shrubby. Leaves or spines awl-shaped, diverging. (*Willd.*) A shrub, with many weak irregular shoots, which have no leaves, but, instead of them, are armed with short stiff spines, in fascicles of 4 or 5 together, and spreading out from each other every way. The flowers are small, and greenish; and the berries, which are larger than those of the common sort, are black when ripe. A native of the south of Europe. Introduced in 1640. We observed it, in 1819, common in the hedges by the road sides, in various parts of Tuscany.

Variety.

a. *A. a. 2 crêticus fruticosus, &c.*, Tourn. Inst., i. 273. — Somewhat more ligneous than the species.

4. *A. (A.) ACUTIFOLIUS* L. The acute-leaved Asparagus.

Identification. Lin. Sp. 449; Reich., 2. 70; Mart. Mill. No. 8; Ait. Hort. Kew., ed. 2. p. 275.
Synonymes. *A. Corrêda* Scop. Carn. No. 417; Vill. Dauph., 2. p. 273; *A. fol. acutis* Bauh. *Pis.*, 200; *A. sylvêtris* Cam. *Epil.*, 200, Matth., 349; *A. petraeus* Ger. *Emac.*, 1130, *Rail Hêc.*, 683; *Corrêda* l. Clus. *Hist.*, 2. 177; Bauh. *Pin. Hist.*, 3. 726.

Spec. Char., &c. Stem unarmed, angular, shrubby. Leaves needle-shaped, rather rigid, perennial, mucronate, equal. (*Willd.*) This species has crooked shrubby stems, with white bark, which rise 4 ft. or 5 ft. high, but have no spines on them; the leaves came out in clusters, like those of the barsh; they are very short, and in sharp prickles. Scopoli thinks that this may be the same as Linnaeus's *A. aphyllus*; what are above called leaves, being, in fact, only spines, which are considered by botanists as abortive shoots. It is a native of Spain and Portugal, and was cultivated in 1708, by *Museo.* We have not seen the plant.

5. *A. HORRIDUS* L. The horrid-spined Asparagus.

Identification. Lin. Syst., 633; Reich., 2. 70, Suppl., 202; Mart. Mill., No. 9.
Synonymes. *A. hispanica* Tourn. Inst., 300.

Spec. Char., &c. Stem shrubby, five-cornered. Prickles four-cornered, compressed, striated. The spines of this plant are said to be 2 in. or 3 in. in length, whence the name. It is a twining shrub, and was introduced in 1600. We have not seen the plant.

GENUS II.



RUSCUS, L. THE BUTCHER'S BROOM. Lin. Syst. Dicotyl. Triandria.

Identification. Lin. Gen., 464; Juss., 43; Fl. Fr., 1073; Tourn., t. 15; Lam., t. 815; Gærtn., t. 16.

Synonymes. *Fragon*, Fr.; *Müusedorn*, Ger.
Derivation. It is said to have been anciently called *Bruscus*, from *brus*, box, and *aleum*, holly (*Calla*), box holly, or from *bruscus*, hem. Some suppose it to be derived from *ruscus*, flesh-coloured; alluding to the color of the fruit. The word *ruscus* was, however, applied to any prickly plant by the ancient Romans, as *ruscus sylvestris*, the holly, &c.

Description, &c. Though, in a practical point of view, the species in British gardens are treated as evergreen shrubs, yet, in a strict sense, they are biennial plants, like the raspberry and the bramble. Popularly, they are evergreen undershrubs, and one a climber. They have stiff sharp-pointed leaves, on which the flowers and fruit of the plant are produced, except in *R. racemosus*. Natives of Britain and other parts of Europe, and of Africa. Soil and culture the same as those of *Sunilax* and *Asparagus*. Though the berry contains the rudiments of several seeds, they are generally all abortive but one. *Sphaera atrovirens* and *S. Ruscii* Fr. are occasionally found upon the different species of this genus.

Synonyma. *R. angustifolius*, *Sw.*, *Tournef. Inst.*, 78.; *Hypocistis* *Asch. Adv. Bot.*; *Lobelia-andriana*, *funcio pediculis incidente*, *Boiss. Pin.*, 304.; *Rail. Hist.*, 663. 2.; *Uvularia* *Dumf.*, 3. 25.; *Fragon à Foliole*, *Fr.*; *Zungen Mäusedorn*, *Ger.*
Engravings. *Lob. Adv. Bot.*, 638.; *Barrel. Ic.*, 250.; *Blackw.*, t. 128.

Spec. Char., &c. Leaves floriferous underneath, with a leaflet. (*Willd.*)
 Root like the preceding. Stems about 10 in. high. Leaves lanceolate, about 3 in. long, and 1 in. broad in the middle, drawing to a point at both ends, and having several longitudinal veins running from the footstalk to the point. They are mostly alternate, but sometimes opposite. On the middle of the upper surface comes forth a small leaf of the same shape; and at the same point, from the bosom of the small leaves, about April or May, come out the flowers, which are of a pale yellow, and have peduncles longer than themselves. The berries are almost as large as those of *R. aculeatus*; they are red, and ripen in winter. Seeds one or two; bony, hemispherical. A native of Italy, Idria, Hungary; and found in Africa, about Algiers. It was cultivated by Gerard, in 1586. There are plants at Messrs. Loddiges's. Desfontaines considers this as a variety of *R. hypophyllum*, differing only in the narrowness of the leaves, and in the flowers emerging from the middle of the leaf, under a leaflet.

4. *R. RACEMOSUS*. L. The racemose Ruscus, or *Alexandrian Laurel*!

Identification. *Lin. Sp.*, 1474.; *Syst.*, 896.; *Reich.*, 4. 285.; *Mart. Mill.*, No. 5.; *Ait. Hort. Kew.*, ed. 2., 5. p. 421.; *Lodd. Cat.*, ed. 1836.
Synonyma. *R. angustifolius*, *fructu summis ramulis*, &c., *Tournef. Inst.*, 78.; *De Ham. Arb.*, 4.; *Fragon à Grappes*, *Fr.*; *Trauben Mäusedorn*, *Ger.*
Engravings. *Dend. Brit.*, t. 145.; our *fig.* 2389. to our usual scale; and *fig.* 2390. of the natural size.

Spec. Char., &c. Flowers hermaphrodite, produced at the ends of the branches. (*Willd.*) Roots like those of the other species: Stalks slender, and much more pliable: they rise about 4 ft. high, and send out many side branches. Leaves oblong, acute-pointed, about 2 in. long, and 1/2 in. broad; rounded at the base, smooth, of a lucid green, placed alternately, and sessile. Flowers in long bunches at the ends of the branches; of a greenish-yellow colour. Berries like those of *R. aculeatus*, but smaller; fleshy, smooth, red, with a round coriaceous white disk at the base; ripening during winter. They are 3-celled, each cell containing one seed; but all the cells, except one, are frequently abortive; from which circumstance the berry often appears 1-celled.

A native of Portugal, cultivated by Miller in 1739. According to some, this species is supposed to be the plant with which the ancients crowned their victors; but, though the stalks are flexible enough to wreath easily, and the leaves resemble those represented on ancient busts, yet the fruit, being terminal, does not agree nearly so well with the fruit represented in the crowns of those busts, as that of the *Laurus nobilis*, which is axillary, and resembles that shown in this coronal wreath.

R. androgynus *Lin. Sp.*, 1475.; *Ait. Hort. Kew.*, No. 4.; *Lodd. Cat.*, ed. 1836., No. 118.; this is the most common of their varieties. It is a native of the County of Lodi, and was introduced before 1713, in the Royal Gardens at Hampton Court. It is a twining shrub, rising to the height of 7 ft. or 8 ft., and is one of the oldest inhabitants of our green-houses; where, when planted in sheltered ground, and allowed to twine round a rod, it produces a fine effect by its numerous green shining leaves, which in the shade become very dark, and pale green when fully exposed to the light. The flowers are white, and are produced in clusters on the edges of the leaves. The berries are round, and at first, green, then yellowish, and finally red. They are smaller than those of *R. aculeatus*, and are not produced in great abundance, though the flowers are numerous, and continue to appear during great part of the summer. As the main source of vitality, in all kinds of plants, is

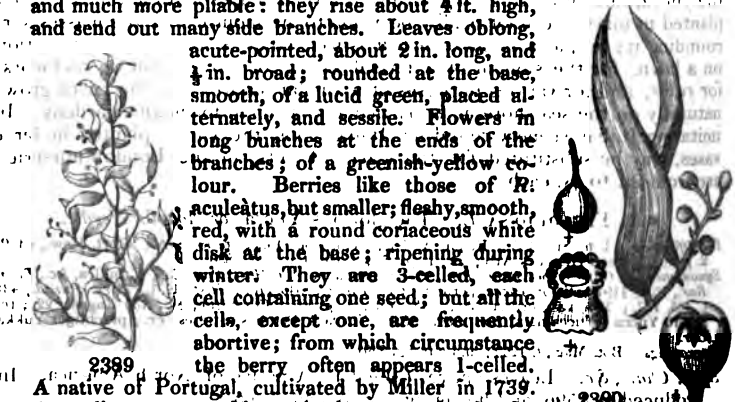

In the east, we have no doubt that *A. austroriparia*, and some other species which are now kept in the green-house, would live against a conservative wall.

GENUS III.



YUCCA L. THE YUCCA, or ADAM'S NEEDLE. *Lin. Syst. Hexandria Monogynia.*

Authorit. Lin. Sp., 456; Benth., 2 88; Willd., 2 183; Alt. Hort. Kew., ed. 2, 2 291; N. O. H. 3, 445.

Derivation. The name of the plant in Peru.
Description, &c. Low evergreen shrubs, with the habit of palm trees; natives of North and South America. In British gardens, most of the species are somewhat tender. They prefer a dry and deep sandy soil, or a sandy loam; and they are readily propagated by suckers, which are thrown up by the roots, or by side shoots, which are occasionally produced on the stem. They sometimes ripen seeds, which, if sown immediately after they are gathered, and placed on a moderate hot-bed, will come up in six weeks. In their native countries, their leaves, treated like the stalks of hemp or flax, afford a fibre which may be used like that of those plants, in the manufacture of cloth or cordage; and the stems, macerated in water, deposit a feculent matter, from which starch may be procured. In a floricultural point of view, all the species are highly ornamental; and no lawn or flower border ought to be without some of them. Considered with reference to landscape-gardening, the yucca, like other trees and shrubs of formal shapes and rigid habit, when planted in masses, cannot readily be made to harmonise with the masses surrounding it; but, as a single object, it is well adapted for attracting attention on a lawn, for the summit of a formal knoll, for growing out of rockwork, for ruins, and for various purposes of a similar nature. As the yucca grows naturally on the sea shore, it is particularly adapted for marine gardens. In imitating Italian scenery round an Italian villa, the yucca, planted in large vases, may be substituted for the agave. Plants, in the London nurseries, are from 2s. to 5s. each.

1. YUCCA L. The glorious Yucca, or Adam's Needle.

Authorit. Lin. Sp., 456; Reich., 2 88; Willd., Sp. Pl., 2 p. 183; Alt. Hort. Kew., ed. 2, 2 p. 291; Desc. Hist. des Arb., &c., 1. p. 17; Lodd. Cat., ed. 1836.
Synonymy. *Y. (Alta) Aloes Barb. Flm.*, 91; *Y. canadensis Ald. Hort. Flav.*, 33; *Y. Indica, &c. Barr. Bar.*, 20, t. 1194; *Y. or Yucca, peruana, Ger. Emac.*, 1548; *Rati Hist.*, 1801; *Park Parod.*, 454; *Y. K. 1*; *Y. nova glorioza, &c. Lab. Adv.*, 2. p. 507; *Cordylite, &c. Roy. Lugd.*, 22; the Yucca Yucca; *Yucca halei, Bosc. Jav.*, 1857; *Yucca A. Fendles entières, Fr.*; *prachoger Yucca, &c.*

Engelm. Bot. Mag., t. 1220; and our fig. 2391.
Spec. Char., &c. Leaves entire. (*Willd.*) A native of North America. Introduced in 1596, and flowering in July and August.

Variety.
Y. g. 2 foliis variegatis Lodd. Cat., ed. 1836, has the leaves variegated.

Description, &c. This species has a stem, or trunk, about 2 ft. or 3 ft. high, clothed with leaves almost to the ground. The leaves are broad and stiff, but thin; they are of a very dark green, and end in a sharp black spine. The flower-stalk is generally about 3 ft. high, branching out on every side to a considerable distance; but the flowers are very wide asunder on the stalk. Sometimes the particles of flowers spring at once from the centre of the leaves, without the intervention of a stalk. The flowers are bell-shaped, and hang downwards; and each petal is white within, but is marked with a purple stripe on the outside. They are scentless, appear from July to September, but are seldom succeeded by seeds in England. This yucca is a native of Virginia and Carolina, of Carthage in New Spain, and of the West Indies; and, though a native of warm coun-



tries, it is perfectly hardy in the climate of London. It was first cultivated in England by Gerard, about 1592, who says: "This plant groweth in all the tract of the Indies, from the Magellane Straits unto the Cape of Florida, and in most of the islands of the Canibals, and others adjoining; from whence I had that plant brought me that groweth in my garden, by a servant of a learned and skilful apothecary of Excester named Mr. Thomas Edwards." Gerard supposed that the cazava, or Indian bread, was made from the root of this plant; but his commentator, Johnson, says that this was "wherein he most shewed his weakness, for that he doth confound it with the manibot, or true yucca." Gerard also supposed that it was "a low herbe, consisting onely of leaves and roots. It hath neither stalks," he says, "flowers, nor fruit, that I can understand of others, or by experience of the plant itself, which hath grown in my garden four yeares together, and yet doth grow and prosper exceedingly." On this passage Johnson observes, that Gerard's plant, "some few yeares after he had set forth his worke, flowered in his garden;" adding that he himself once saw a yucca in flower "in the garden of Mr. Wilnot, at Bow, but never since, though it hath been kept for sundry yeares in many other gardens, as with Mr. Parkinson and Mr. Tuggy." Respecting the plant in Gerard's garden "at Holborne, in the suburbs of London," Parkinson, in his *Paradisus*, p. 434, tells us that Gerard kept it till his death; after which "it perished with him who got it from his widow, intending to send it to his country house;" adding that Gerard sent a sucker of it to Robin, gardener, to Henry IV. in Paris, which was the first seen in France. Michaux found it growing on the sea shore in Carolina. The fibres of the leaves are used by the Indians to make a kind of cloth, and also cords, which they use to fasten

their houses together, and to make their swinging beds, called hammocks. At Carthagena, a starch, or rather glue, is made from the stem, which is sold there at 1½d. the Spanish pound. A specimen of this starch was sent to us in 1834, by Dr. Hamilton of Plymouth. (See *Gard. Mag.*, vol. x. p. 454.)

‡ 2. *Y. (G.) SUPERBA.* The superb Yucca.

Identification. Haworth Suppl. Plant. Succ., p. 35; Bot. Reg., 1698.

Synonymy. *Y. gloriosa* *Asd. Bot. Rep.*, t. 473.

Engravings. *Bot. Rep.*, t. 473; *Bot. Reg.*, t. 1698; and our fig. 2392.

Spec. Char., &c. Stem arborescent. Leaves sword-shaped and plaited, with a very strong spine. Flowers ovate, bell-shaped, and drooping; pure white. (*Asd.*) This species was separated from *Y. gloriosa* by Mr. Haworth, on account of its more arborescent stem, the greater density of the flowers, and the whiteness of their petals when expanded; the young buds, however, have a tinge of purple like those of *Y. gloriosa*. In cultivation in Malcolm's Nursery about 1810; and there are plants in the Horticultural Society's Garden.



‡ 3. *Y. ALOIFOLIA* L. The Aloe-leaved Yucca, or Adam's Needle.

Identification. *Lin. Sp.*, 457; *Reich.*, 2. 83; *Willd.*, 2. 184; *Mart. Mill.*, 2; *Alt. Hort. Kew.*, ed. 2, p. 291; *Desf. Hist. des Arb.*, &c., 1. p. 18; *N. Du Ham.*, 3. p. 146; *Lodd. Cat.*, ed. 1836; *Ben Jard.*, 1837.

Synonymy. *Y. arborescens*, &c. *Dill. Elth.*, 435; *Aloe Yuccæ foliis, cauliscescens, Fluk. Alm.*, 19, *A. americana Yuccæ foliis, arborescens, Com. Præl.*, 64; *Y. cauliscescens, foliis linearilanceolatis, &c., Michx. Fl. Bor. Amer.*, 5. p. 196.

Engravings. *Dill. Elth.*, t. 323. f. 416; *Fluk. Alm.*, t. 286. f. 4; *Comm. Præl.*, t. 14; *Bot. Mag.*, t. 1700; and our fig. 2393.

Spec. Char., &c. Leaves crenulate, stiff. (*Willd.*) A native of South America. Introduced before 1696, and flowering in August and September.

Variety.

‡ *Y. a. 2 péndula* *Cat. Hort. Par.*, p. 24., *N. Du Ham.*, iii. p. 147., *Ben Jard.*, ed. 1837, has the leaves pendent.

Description, &c. A remarkable palm-like tree, with a thick tough stem or trunk, 10 ft. or 12 ft. high, crowned with a head or tuft of stiff, narrow, light green leaves, the edges of which are slightly serrated, and the points ending in sharp, strong, very hard spines. The flower-stalk rises from the centre of the leaves, and is 2 ft. or 3 ft. high, branching out so as to form a pyramid. The flowers grow close to the branches, and form a regular spike: they are purplish without and white within. When the flowers have dropped, the head from which they sprang dies; but, generally, one or two young heads come out from the side of the stalk, below the old head. This species is rather more tender than *Y. gloriosa*. It is a native of South America, and was cultivated before 1696, in the Royal Gardens at Hampton Court. Fig. 2394 is a portrait of a plant, or rather tree, of *Y. aloifolia*, growing in the gardens at Adare, which was taken in October, 1837, and kindly sent to us by the Countess Dunraven. The plant measured 28 ft. in height; the circumference of the trunk, at 10 ft. from the ground, is 17 in.; and, at the height of 20 ft., it divides into six massy branches, each terminating in a pyramid of flowers. In the figure, only four of these branches are exhibited, this being the greatest number that could be seen at one time from any one point of view. It is supposed to have been planted upwards of 40 years, and appears, from the drooping habit of the leaves, to be the variety *Y. a. péndula*. It is the finest specimen of Yucca that we





have had any account of, either at home or abroad. There are plants, both of this variety and of the species, in the Horticultural Society's Garden, in the Epsom Nursery, and at Messrs. Loddiges's.

2 4. Y. DRACONIS L. The Dragon Yucca, or drooping-leaved Adam's Needle.

Identification. Lin. Sp., 457; Reich., 2. p. 84; Willd., 2. 184; Mart. Mill., No. 3; Ait. Hort. Kew., ed. 2, 2. p. 291; Desf. Hist. des Arb. et Arbrius, 1. p. 18; Ham. Supp., p. 33; Elliot Fl. S. Car., 1. 401; Lodd. Cat., ed. 1836; Bon Jard., ed. 1837.
Synonymes. Y. draconis folio serrato reflexo Dill. Eith., 457. Com. Prax., 42. 67; Draconi Arbori, &c., Bauh. Pin., 506; Tacóni folio Dracóni arboris simili Bauh. Hist.
Engravings. Dill. Eith., 324. 117; Bot. Reg., t. 1894; and our fig. 2395.

Spec. Char., &c. Leaves crenated, nodding. (Willd.) Native of South Carolina. Introduced in 1732, and flowering in October and November.

Description, &c. Stem rising to the height of 3 ft. or 4 ft. Leaves narrow, dark green, hanging down, serrated, and ending in acute spines. Flowers pendulous, milk-white, with a strong unpleasant smell. Gartner describes the fruit as a fleshy oblong berry, contracted at the top, with a narrow aperture between the sessile stigmas; obscurely 6-cornered and 6-celled; cuticle very thin, not separating; pulp firm, of a dark dusky blood-red colour; three of the partitions thicker than the other three, all longitudinal: between these are transverse, membranaceous, very thin, white diaphragms, forming partial cells for each of the seeds. Receptacle none, except the central angle of the cells, to which the seeds are fastened horizontally in a single longitudinal row. Seeds numerous, spherically triangular; flattish on both sides, dark, but not shining. This species is a native of South Carolina, whence Miller received the seeds under the name of oil-seed. It had, however, been previously introduced into Europe; and it flowered in August, 1729, at Hamburg, in the garden of M. Von Sprekelsen. The plant was 20 years old, with a trunk 8 ft. high, and the flower-stem was 2 ft. 6 in. long. The flowers were white, and about 150 in a thyse. The seed-vessel was 3-celled; and the seeds were horny, wrinkled, and blackish when ripe. Y. draconis, says Dr. Lindley, in the *Botanical Register* for September, 1836, "is one of the most stately species of the genus. It grows along the sea shore of Carolina, frequently intermixed with Y. gloriosa; and flowers from May to August, and sometimes grows as much as 9 ft. or 10 ft. high. The great peculiarity by which it appears to be distinguished is, the spreading of the flowers, the segments of which, instead of remaining closed in a globose manner, as in most of the other species, expand till they diverge from the flower-stalk nearly at a right angle. The main stem, clear of leaves, was [in the plant figured in the *Botanical Register*] 2 ft. long, and terminated in three clusters of leaves, from the centre of each of which rose a flower-stem 3 ft. high. The foliage, notwithstanding its stiffness, does not offend the eye, as the leaves gradually turn back as they grow old," till at last they form a very graceful arrangement. "Nothing can be better adapted than these plants, for ornamenting either artificial or natural masses of rockwork, precipitous banks, or other situations where their singular stems can be so much above the eye as to form a bold and prominent object standing out in strong relief against the sky." Y. draconis is perfectly hardy, and stands out, without the slightest protection, in the nursery of Messrs. Backhouse of York. There are also plants standing out in the Horticultural Society's Garden at Chiswick, which "no weather seems to harm." (*Bot. Reg.*) Dr. Lindley also observes that yuccas are very suitable for gardens near the sea coast, from that situation being similar to their native habitat.



2 5. Y. STRICTA Sims. The upright Yucca, or Lyon's narrow-leaved Adam's Needle.

Identification. Sims in Bot. Mag., t. 2222.
Engravings. Bot. Mag., t. 2222; and our fig. 2396.

Spec. Char., &c. With a stem. Leaves linear-lanceolate, very stiff; elongated at the apex. Flower-stem branched at the base; branches simple. Flowers orbiculate, bell-shaped. (*Sims.*) The leaves are very long, straight, and tapering to a long point, with a very few scattered threads on the margin. They are of a deep green, edged with yellow. The flowers are globular, greenish, with a purplish tinge, and large. The flower-stem is about 4 ft. or 5 ft. high, growing very upright, and branching at the base. It was found in Carolina by Lyon, and introduced about 1817.



2396

■ 6. *Y. RECURVIFOLIA* *Salm.* The recurved-leaved Yucca.

Identification. *Salm.* in *Parad. Lond.*, 31.; *Pursh Fl. Amer. Sept.*, 1. p. 228.
Synonymy. *Y. recurva Hort.*

Spec. Char., &c. With a stem. Leaves linear-lanceolate; green, recurved, deflexed, slightly thready on the margin. Petals broad in the interior. (*Salm.*) Stem about 3 ft. high. Flowers a greenish yellow, with a tinge of purple. Found on the sandy shores of Georgia by Le Comte; flowering in July and August. Introduced in 1794.

■ 7. *Y. FILAMENTO'SA.* The filamentose Yucca, or thready Adam's Needle.

Identification. *Lin. Sp.*, 457.; *Reich.*, 2. 84.; *Willd.*, 2. p. 184.; *Trew Ehret.*, t. 57.; *Mart. Mill.*, No. 4.; *Alt. Hort. Kew.*, ed. 2., 2. p. 291.; *N. Du Ham.*, 3. p. 147.; *Lodd. Cat.*, ed. 1836; *Bon Jard.*, ed. 1837.
Synonymy. *Y. foliis filamentosis Moris. Hist.*, 2. 419.; *Y. virginiana, &c., Pluk. Alm.*, 365.
Engravings. *Bot. Mag.*, t. 900.; and our *fig.* 2397.

Spec. Char., &c. Leaves serrated and thready. (*Willd.*) The stalk and leaves are like those of *Y. gloriosa*; but the leaves are obtuse, and have no spines at their ends. The flower-stalk rises 5 ft. or 6 ft. high, and is generally covered with flowers for most of its length. The flowers are larger and whiter than those of *Y. gloriosa*, and sit close to the stalk. On the sides of the leaves are long threads, which hang down. *Morison* states that he saw this species bearing seeds in the garden of Mr. George Crook of Waterstock, near Oxford, in 1675; and that the capsules were 3-sided and 3-celled. It is a native of Virginia, and flowers in September and October. It is perfectly hardy.



2397

■ 8. *Y. (Y.) ANGUSTIFOLIA* *Pursh.* The narrow-leaved Yucca.

Identification. *Pursh Fl. Amer. Sept.*, 1. p. 227.; *Nuttall Gen. Pl. Amer.*, 1. p. 218.; *Sims* in *Bot. Mag.*, t. 2236.
Engravings. *Bot. Mag.*, t. 2236.; and our *fig.* 2398.

Spec. Char., &c. Without a stem. Leaves long-linear, rigid; margin slightly filamentose. Capsules large, obovate-cylindrical. (*Pursh.*) This species has been sometimes confounded with *Y. stricta*; but the leaves are narrower, and more recurved, and the threads on the margin much longer. The whole plant is of humbler growth: the flower-stem is not branched; and the flowers are more oblong than round, and of a greenish white, without any tinge of purple. Found by Nuttall on the banks of the Missouri; and



2398

described by Pursh, from the specimen in Nuttall's herbarium. Closely resembling *Y. filamentosa*. Introduced in 1811.

■ 9. *Y. FLA'CCIDA* Haw. The flaccid-leaved *Yucca*.

Identification. Haw. Supp., p. 35; Lindl. in Bot. Reg., vol. 2399
xxii., under *Y. dracōnis*.
Engravings. Bot. Reg.; and our fig. 2399.

Spec. Char., &c. Leaves all very flaccid, weak, bent below the middle and recurved, very long and lanceolate, flat, concave and mucronulate at the apex, roughish; marginal filaments strong, yellowish. (*Haworth Suppl.*, p. 35.) "A pretty and apparently distinct species, well marked by its thread-edged scabrous leaves, and pale flowers, which appear in July." Introduced from Georgia in 1819.



■ 10. *Y. GLAUCE'SCENS* Haw. The glaucescent *Yucca*.

Identification. Haw. Sup. Pl. Suc., p. 35.; Swt. Brit. Fl.-Gard., t. 53.
Engravings. Brit. Flow.-Gard., t. 53.; and our fig. 2400.

Spec. Char., &c. Leaves linear-lanceolate, entire, concave, glaucescent, straight; margin slightly filamentose. (*Swt.*) A stemless species, with very stiff concave leaves, of a dull glaucous colour, terminating in a sharp horny spine; margin entire, with here and there a slender white thread, slightly twisted. Flowers of a greenish white, tinged with yellow. A native of North America. Introduced by Mr. John Lyons in 1819. This plant was first given to the nurseries from High Clere, where it flowers freely every year. It has the habit of *Y. filamentosa*, with larger and more numerous blossoms, and more elegant sharp-pointed foliage. (See *Gard. Mag.*, vol. x. p. 254.)



CHAP. CXVII.

HALF-HARDY MONOCOTYLEDONOUS PLANTS, DESERVING A PLACE IN THE BRITISH ARBORETUM.

FOURCROYA longæ'va Karw. et Zuccar. Trans. Munich, vol. xvi. part 2. t. 48, 49. A splendid plant, brought from South America to Europe, in 1828, by the Baron Karwinski; and introduced into England by M. Francis Rauch, in 1833. A tree, with a straight cylindrical trunk, 40 ft. or 50 ft. high, and from 12 in. to 18 in. in diameter, and surmounted by a flower-stem from 36 ft. to 40 ft. high. It is found on the summit of Mount Tanga, in the province of Oaxaca in Mexico, at an elevation of 10,000 ft. above the level of the sea, growing in declivities



along with oaks and arbutuses. It flowers there in May, and ripens its fruit in the following winter. Baron Karwinski mentioned to M. Rauch, in 1833,

that, where he found the plant, the ground was covered with snow and ice; so that there can be no doubt of its being hardy in the climate of London. It is of such remarkably slow growth in its native habitats, that the inhabitants say it flowers only once in 400 years. Fig. 2402., reduced from Baron Karwinski's plate to a scale 1 in. to 12 ft., shows the general appearance of the full-grown plant, with its noble spike of flowers. Fig. 2401. shows the flowers of the natural size. Only seven plants were introduced, one of which was purchased by the Duke of Devonshire, and the rest sold to Messrs. Loddiges. Price five guineas each.

F. gigantea Vent., Bot. Mag., t. 2250., is an agave-like plant, with leaves 7 ft. long, and a flower-stem 30 ft. high; a native of South America: introduced in 1690. It flowered in 1821, at the Earl of Powis's seat at Wallcot, Shropshire.

Litsea gemmiflora Brig.; *Aga've gemmiflora* Ker; *Bonaparteia juncea* Haw., Hort. Journ. Roy. Inst., iii. t. 1.; and our fig. 2403.; is a native of Peru, introduced in 1800; and, though commonly kept in the green-house, it is probably as hardy as some kinds of *Yucca*. The plant of which our figure is a portrait, with a single flower of the natural size, flowered in the conservatory of Knight's Exotic Nursery, King's Road, in 1826. The flower-stem first appeared about the



middle of August; and, for about six weeks, it made the rapid growth of about 4 in. every 24 hours. After this, its growth gradually became slower, till, on the 11th of November, the spike was 14 ft. high, as shown in the figure, and bearing 846 flowers in various stages of progress. The flowers were green without, and of a greenish yellow within. A specimen in the conservatory of the geographical establishment of Van der Maelen at Brussels flowered in December, 1837. The height of the flower-stem was 30 ft., and it was furnished with from 1200 to 1500 flowers. The same plant had flowered some years previously, so that this second flower-stem in all probability proceeded from a sucker. (*L'Echo du Monde Savant*, Dec. 29., 1837.) The plant has ripened seeds freely in the conservatory of M. Soulange-Bodin, with whom it flowered in 1825, and who had, in the following year, 1000 plants raised from its seeds.

Agave americana, the American Aloe, a native of the tropical part of South America, on mountains 900 ft. above the level of the sea. "Thence," says Sir W. J. Hooker, "it has been introduced into the warmer parts of the old world, where fences are made of it, and a fermented liquor called *pulque*; and fibres for thread, and a substance analogous to soap, have also been extracted. It was, by the late Mr. Yates, planted in his garden at Saltcombe Bay, in Devonshire, in 1804, when only 3 years old, and but 6 in. high. It was placed in the open air, without any protection, save what was afforded by the neighbouring hills. In the year 1820, it had attained a height of 11 ft., and covered a space of ground the diameter of which was 16 ft., when it threw up a flower-stem, which grew for 6 weeks at the rate of 3 in. a day, and in September measured 27 ft. in height, its branches being loaded with 16,000 blossoms; thus contradicting the generally received opinion, that the American aloe flowers only once in 100 years." (*McCulloch's Statistics of the British Empire*, i. p. 126.)

Phormium tenax, the New Zealand Flax, is also quite hardy both in the south of England and Ireland, and is technically a shrub.

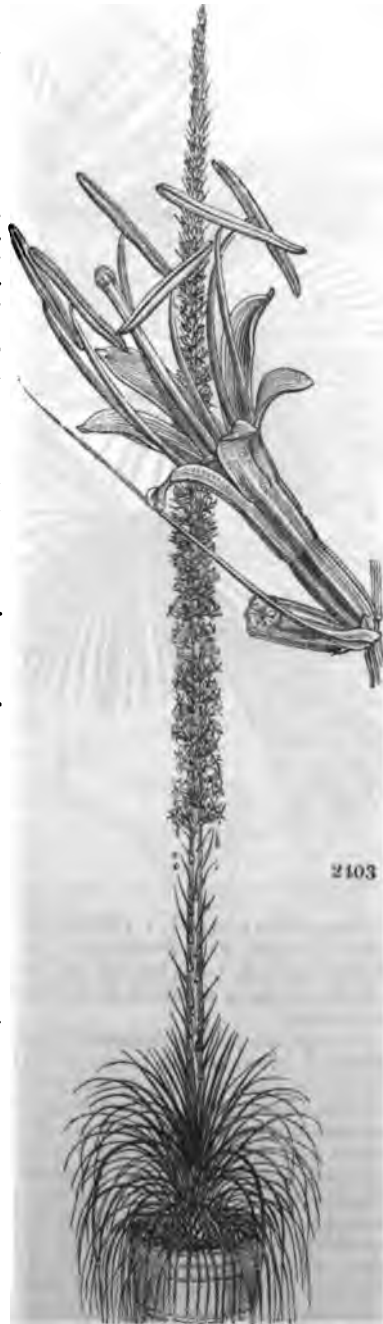

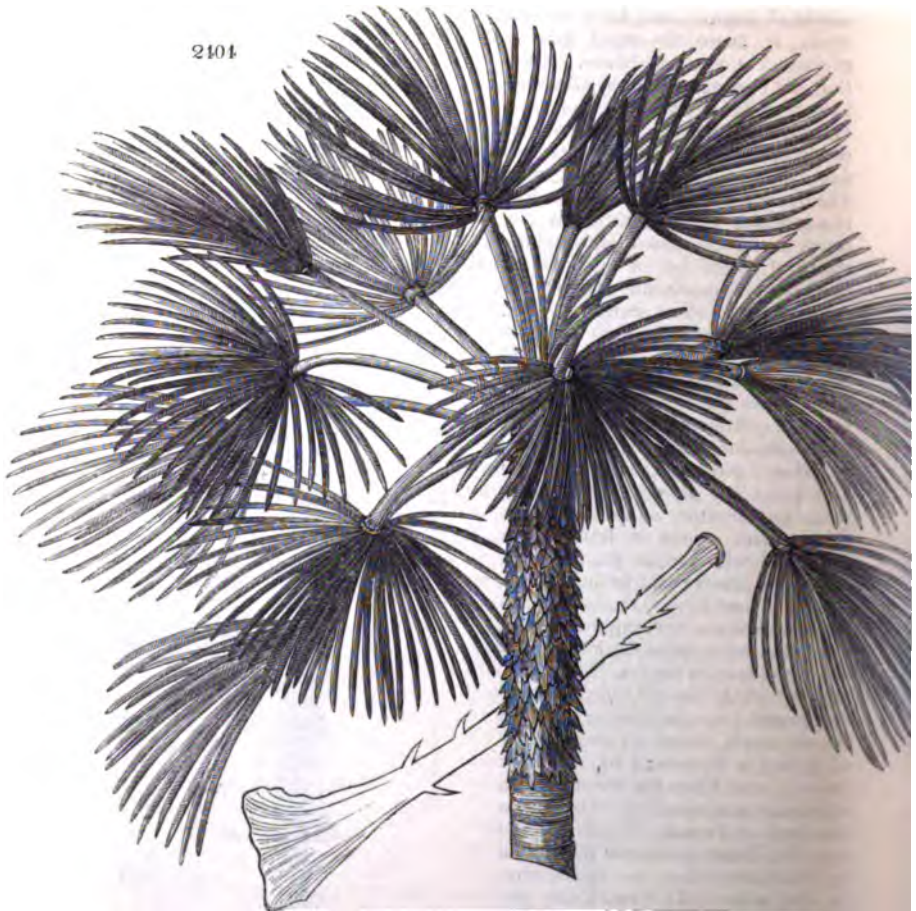

Chamaerops humilis L. ; *Phoenix humilis* Cav. ; *Palma humilis* Benth. ; *Palmiste E'ventail*, Fr. ; *Zwergpalme*, Ger. ; the dwarf Fan Palm, or Palmetto ; N. Du Ham., iii. t. 58., and our fig. 2404. ; is a native of the south of Europe, and, in dry warm situations in England, will stand the winter with very little protection.

Though this palm is designated dwarf, yet, according to the *Nouveaux Du Hamel*, it grows to the height of 30 ft. or 40 ft. in Spain; and one in the *Jardin des Plantes*, in a tub, attained the height of 30 ft. In England, one in an old conservatory at Buckeridge House, near Godalming, was, in 1836, upwards of 12 ft. high. The trunk of plants of this size is cylindrical, perfectly naked from the ground to within a short distance of the leaves, where scales commence, of a reddish hue, being the bases of the footstalks, which remain for some years after the leaves and petioles have dropped off; and which scales, with great plausibility, have been considered as giving the first hint for the foliaged capitals of Corinthian columns. As this palm produces abundance of seed in Italy and Sardinia, if large quantities of it were imported, and the plants raised from it exposed to the frost, some would doubtless be found more hardy than others; and these might be perpetuated from the suckers, which rise abundantly from the roots. The soil which this palm prefers is a deep sand; in which soil it is said to grow in the south of Europe, and spread

over the surface, in the same manner as the fern does in England. As a single object on a British lawn, few, in rarity and singularity, can surpass a handsome fan palm. A plant has stood out in the open air in the Edinburgh Botanic Garden for several winters, with scarcely any protection.

The *Chamærops humilis*, being a plant of small size and slow growth, is very easily covered in such a manner as effectually to exclude frost; and, if it is found worth while to protect the pines and araucarias of warm climates, it surely will not be thought too much to recommend the bestowing of this care on the only species of palm yet known which is likely to make a fine appearance in the open air in British gardens. It may be observed, that the dwarf fan palm, having strong tough fronds, may be protected throughout the winter without the admission of light, which adds greatly to the facility and economy of the operation of protection. On the other hand, pines, firs, and most dicotyledonous plants, when protected during winter, not only require the frost to be excluded, but light and air to be frequently admitted. A cylindrical frame of iron rods, with a cover formed of a slightly convex plate of zinc, manufactured by Messrs. Cottam and Hallen, is well adapted for protecting plants of this kind. The zinc cover throws off the rain and protects the plant under it from perpendicular snows, while the sides are covered with mats, which can be taken off or put on at pleasure, and in a few minutes. Fig. 2406. shows one section of the skeleton cylinder, which may be increased to any height by placing others of the same dimensions over it; and fig. 2405. shows the zinc cover. Covers of this kind are admirably adapted for protecting shrubs which flower early in spring, such as the *Pæonia Moutan*, *Magnolia conspicua*, camellias, &c.; and in autumn they may be placed over currant bushes, or over Buttner's mirellio cherry trees; by which means the fruit may be preserved hanging on the branches, and fit for the table, till November. Instead of having the skeleton cylinders of iron, and the cap zinc, the former we should greatly prefer

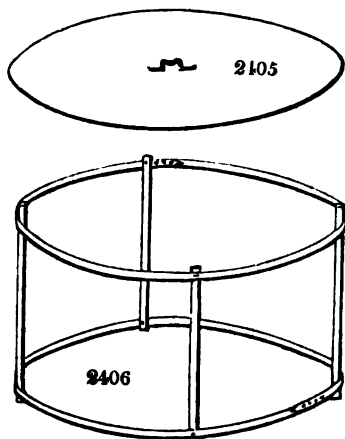

being made of Kyanised willow or hazel rods, and the latter of oiled paper, or of birch bark fastened to a wickerwork frame. Even if the cap were 5 ft. or 6 ft. in diameter, it might still be covered with plates of bark, such as that of oak, beech, birch, &c., cut in the form of plain tiles, but larger for placing round the circumference, and smaller for the centre, and projecting a few inches all round, so as to clear the sides from the drip and perpendicular rain. The different sections forming the sides might also be covered with bark, or, if not with bark, with straw or reeds, unbruised, and placed in a vertical direction, so as to throw off side rains. Where these frames are used, they are commonly covered with straw or hay ropes, or with bast mats; but, these not presenting either a smooth surface like the bark, or a channeled surface like the straw or reeds, absorb the moisture which falls on them, and thus not only chill the atmosphere within, by the evaporation which takes place while they are drying, but rot the material. We have a great objection to the use of iron in the support or protection of plants, where wood can be substituted, and an equal objection to the preference generally given to wood prepared with the saw and the plane, and painted, rather than to poles or rods with the bark on. The reason for our objections is: the great disparity between the nature and durability of the protector and supporter, and the thing protected or supported. The means appear badly adjusted to the end, and the end seems as it were only secondary to the means. It is true, there has been hitherto a

powerful inducement to the use of iron rods for supporting standard roses, dahlias, and similar plants, and it is very proper that such rods should be painted to give them durability; but there is less excuse for employing iron rods, or rods of joiner's work, for tying up small green-house plants, and small plants in the open border; and none, as we think, for painting either wooden or iron rods of a pea-green. The natural colour of the bark of young trees is, in our opinion, greatly preferable. In the present day, when it is so clearly proved that stakes and rods with the bark on can be rendered at least of 6 or 7 years' duration by the kyanising process, we should always recommend their use in preference to iron. We acknowledge, however, the value of the latter material for espalier rails, some descriptions of trellis-work, sash-bars, &c.

C. serrulata Willd., Michx. Fl. Bor. Amer., i. p. 206., Pursh Fl. Amer. Sept., i. p. 239., grows on the coast of Georgia and Florida, and differs very little from the dwarf fan palm of Europe.

C. hystrix Pursh, l. c., p. 240., has a creeping root, like the former, but differs in having the petioles of the leaves long, with prickles resembling porcupine's quills. Found near the town of Savannah, in Georgia.

C. Palmétto Willd., Pursh, l. c., Michx. N. Amer. Syl., iii. l. t. 101.; *Côrypha Palmétto* Walt.; the Cabbage Tree, Amer. This is a tree with a trunk from 40 ft. to 50 ft. high, of a uniform diameter, and crowned with a regular and tufted head, composed of leaves of a brilliant green, palmated, and borne by petioles from 1 ft. 6 in. to 2 ft. long, nearly triangular and united at the edges. The leaves vary in length and breadth from 1 ft. to 5 ft., and are so arranged, that the smallest occupy the centre of the summit, and the largest the circumference. Before their developement, they are folded like a fan; and, as they open, the outside sticks of this fan separate and fall, leaving the base surrounded with filaments woven into a coarse and flimsy russet web. The base of the unclosed bundle of leaves is white, compact, and tender: it is eaten with oil and vinegar, and resembles the artichoke and the cabbage in taste; whence the American name of the cabbage tree. The flowers are of a greenish hue, and are produced in long clusters: they are succeeded by black horny fruit, about the size of a pea. This tree is found on the sea coast of Carolina and Florida, where the wood is used for forming piles for building wharfs; for which purpose it is preferred, though it is extremely porous, from its power of resisting the attacks of the sea-worms, which, during summer, destroy most other kinds of wood placed in situations accessible to them. When subject to be alternately wet and dry, it decays as rapidly as any other wood. In the war of independence, it was used for building forts, as, when a ball entered the wood, it immediately closed over it. (*Michx.*) The leaves are manufactured into light and very durable hats. — As there are several trees and shrubs, natives of Carolina, Florida, and Georgia, which endure the open air in England, it is at least worth while to try these three palms, which are, probably, as hardy as the *Chamærops humilis*.

Bambusa; the Bamboo. There are two kinds of bamboo in the Horticultural Society's Garden, which have endured the open air for 10 or 12 years, without any protection whatever. One of these, *B. nigra* Lodd. Cat., the black bamboo, was, in 1837, 7 ft. high, with several stems varying in thickness from $\frac{1}{2}$ in. to 1 in. Though a native of India, it appears nearly as hardy as the European reed. Another species, in the same garden, *B. arundinacea*, has stood out during the same period at the base of a wall with an eastern aspect, but has not grown so freely, probably owing to its being in a drier soil. In Jersey, there are several species and varieties in Saunders's Nursery, which stand out perfectly well without any protection.

Arundo Donax is a grass with woody stems, a native of the south of Europe; and on Mount Ætna supplying stakes for supporting the vine. It sometimes grows 15 ft. high in one season, in the climate of London; and makes a fine appearance on the rocky margin of a pond.

SUPPLEMENT,

CONSISTING OF

ADDITIONS AND CORRECTIONS.

Part I. HISTORY AND GEOGRAPHY, ETC.

WHEREVER the words "*Schubertia disticha*" occur, substitute "*Taxodium distichum*;" for "*Abies Picea*," read "*Picea pectinata*;" and for "*Pópulus dilatata*," read "*Pópulus fastigiata*."

Page 48. line 6., for "70," read "65."

51. l. 15., for "*fruxinifolia*," read "*fraxinifolia*."

58. l. 15. and 16., for "the Misses Gostling, the present proprietors of Whitton Place," read "John Gostling, Esq., the present proprietor of Whitton Park."

75. l. 7. from the bottom, for "William Swainson, the proprietor of some popular vegetable medicines," read "Isaac Swainson, who was originally a clerk to a woollen draper, but who afterwards purchased a share in De Verno's Vegetable Syrup."

78. l. 22. ditto, for "the stock was sold off," &c., read "the stock was advertised to be sold off, and the ground let for building on," &c.

91. l. 16. from the top, after "*amerina*," insert "[*decipiens Hoffman*; see *Hook. Brit. Flor.*, i. p. 414.]"

l. 20., for "*longifolia*," read "*palustris [australis]*."

97. l. 16. from the bottom, after the word "son," insert "of the brother."

103. l. 15. ditto, for "ii.," read "iii."

106. l. 8. ditto, dele "*L.*"

119. l. 21. from the top, dele "*inèbrians*."

125. l. 12., insert "*c.*" before "*Douglàssi*," and "*[C. occidentale]*" after it.

after l. 16., insert :—

"*Cratægus Douglàssi*
punctata brevispina."

after l. 19., insert :—

"*Philadélphus Gordoniana*."

l. 25., for "*Pinus Sabiniana* var.," read "*Pinus macrocarpa [Coulteri]*."

l. 10. from the bottom, for "Meath," read "King's County."

134. l. 3., dele "*mediterranea*."

135. l. 18., after "*Characias*," add "or *amygdaloides*."

140. l. 7., from the bottom, after "*deciduus*," insert "*cypress*."

145. l. 26. ditto, for "nearly 50 ft.," read "35 ft.; and its age, as estimated by Dr. Kops in 1835, between 70 and 80 years."

146. l. 15. ditto, dele "*Euphorbia sylvatica*."

148. and 149., for "*Schwöbbache*," read "*Schwöbber*."

149. l. 7. from the top, insert, after full stop, "(See *Gard. Mag.*, viii. p. 445.)"

151. l. 2., dele "*Làrix europæa*, *microcarpa*, and *péndula*."

l. 5., dele "*androgynus*."

153. l. 6. from the bottom, dele "*Linnæa borealis*."

l. 9. ditto, dele "*Phyllodoce taxifolia (Menzièsia cærulea)*."

l. 13. ditto, dele "*hastata*."

l. 16. and 17. ditto, dele "*Potentilla fruticosa*."

- Page 156. line 18. from the bottom, dele "Phyllodoce cærulea."
 166. l. 3. ditto, dele "minor."
 l. 13. ditto, dele "mediterræna (Portugal)."
 167. l. 18. ditto, dele "sylvatica (Portugal and Sicily) Characias."
 173. l. 14. ditto, insert "†" before "fraxinifolia;" and dele "†" before
 "Dobinæ'a."
 177. l. 21. from the top, after "chinense," insert "longiflorum."
 180. l. 22. and 23., dele "polifolia angustifolia, polifolia latifolia."
 l. 29., dele "cærulea."
 181. l. 34., dele "Empetrum nigrum."
 184. l. 11. from the bottom, for "shrub," read "scrub."
 188. l. 26. ditto, for "has since been added," read "was published in 1832,
 and a third in 1837."
 l. 25. ditto, before "has," insert "of the first two volumes."
 189. l. 24. ditto, insert "North" before "American."
 192. last line, for "Encyclopædia," read "work."

Part II. OF THE SCIENCE OF THE STUDY OF TREES.

Page 193. to p. 230.

195. l. 31. and 32. from the bottom, for "Sórbus," read "Pýrus."
 201. l. 32. ditto, dele "first."
 206. l. 14. from the top, for "Part IV. of this Encyclopædia," read "our
 Encyclopædia of Arboriculture."
 209. l. 5. from the bottom, for "the series of plates," &c., read "our volumes
 of plates."
 l. 7. ditto, for "These, in the plates," &c., read "These, in our volumes
 of plates."
 210. l. 19. from the top, for "volume," read "volumes."
 219. l. 13. from the bottom, for "Encyclopædia," read "work."
 223. l. 4. and 5. from the top, for "the plates which form a separate volume,"
 read "our volumes of plates."
 l. 17., for "all," read "most."

Part III. THE ARBORETUM ET FRUTICETUM BRITANNICUM.

Page 231. to p. 2592.

Wherever the words "our plate in Vol. II.," or "our plate in Vol. III.,"
 occur, substitute "in our volumes of plates."

CLEMATIDÆ.

- Fungi.* 233. l. 13. from the top, after the full stop, insert:—"The principal
 fungi found on the Clematidæ are, *Solenia urceolata Walbr.*, and
Æcidium Clematidis Dec."
Clematis tritermâta. 238. l. 21., add: "According to Mr. Gordon, it is of
 stronger growth than any of the atragenes; and is so like *C. virginiana*,
 as to be probably only a variety of that species."
Flammula. 240., at the end of § i., introduce:—
 "C. *nepalensis* Dec. Syst., i. p. 164., Prod., i. p. 9., Wall. Cat., 4680.,
 Royle Illust., p. 51.; *C. montana* D. Don, Prod., p. 192.; *C. m.* var. *Ham. MSS.*
 Peduncles many; each 1-flowered, longer than the leaves, jointed, and with
 an involucre below the apex. Leaves ternate or trifid, glabrous; leaflets
 lanceolate, acute, cut, 1-nerved. Perianth oblong, ash-coloured, and woolly.

(*D. Don.*) A native of Choor, Urukta, and other mountains in the Himalayas, at the elevation of from 9,000 ft. to 10,000 ft.; flowering in May. (*Royle.*) There is a plant in the Horticultural Society's Garden, which has not yet flowered; but, from its foliage, Mr. Gordon considers it to belong to the ♂ *Flammula*.

"*C. Hendersōnii Hort.* There is a plant in the Horticultural Society's Garden bearing this name, which was raised from seed by Mr. Henderson of Pine-Apple Place. It has the appearance of the herbaceous species of *Clematis*, *C. integrifolia*, but is decidedly shrubby."

C. florida. Page 241. line 3. from the top, for "*Variety*," read "*Varieties*;" and insert 2 after *f.* After line 5., add:—

"*C. f.* 3 *Sieboldti D. Don* in *Sweet's Brit. Fl. Gard.*, t. 396.; *C. Sieboldti Pax. Mag. of Bot.*, iv. p. 147.; *C. bicolor Hort.*—This is a very beautiful variety. The sepals are cream-coloured suffused with violet spots, so as to give the plant what is termed by florists a dark eye. The leaves and branches are more hairy, and the flowers much larger than those of the species. It is a native of Japan, whence it was brought to Europe by Dr. Van Sieboldt; and Messrs. Low and Co. of the Clapton Nursery introduced it into England from Belgium in 1836. (See *Gard. Mag.*, vol. xiii. p. 430.)"

Before *C. Viticella*, insert:—

"**1** *13. *C. CÆRU'LEA Lindl.* The blue, or violet, flowered *Clematis*.

Identification. Lindl. in *Bot. Reg.*, t. 1955.
Synonymes. *C. azurea grandiflora Sieb.*; *C. grandiflora Hort.*
Engravings. *Bot. Reg.*, t. 1955.; and our *fig. 2407*.

Spec. Char., &c. Leaves spreading, hairy, ternate; segments ovate-acute, entire. Peduncles 1-flowered; sepals 6—8, oblong, lanceolate, acute, membranaceous; margin distended. (*Lindl.*) It is a free-growing and profuse-blooming plant, with large violet-coloured flowers, and deep purple stamens. Dr. Lindley observes that it is nearly related to *C. florida*, from which it differs not only in the colour, delicacy, and transparency of its blossoms, but also in its leaves being only once ternate, and in the sepals not touching and overlapping each other at the edges. A native of Japan. Introduced into Belgium by Dr. Van Sieboldt, whence it was sent to England to Messrs. Loddiges, in 1836."

C. Viticella. 241. l. 3. from the bottom, dele:—

"**1** *C. V. baccata Dec.* The berried-fruited *Vine-bower Clematis*;" it being the same as *C. campaniflora*.

C. campaniflora. 242. add "*C. Viticella baccata Dec.*" to the list of synonymes.

C. balearica. 244., add to the list of *Engravings*, "and our *fig. 2408*."

C. montana. 245. l. 2. from the bottom, after the full stop, insert:—"It was first sent home in 1831, by Lady Amherst."

246. l. 4. from the top, add: "It may also be propagated by cuttings."

Anticipated Introductions. 246. l. 21., dele "*nepalensis*."

PRONIA'CEÆ.

Pæonia. 250. l. 5. from the top, add: "*Sphæria flaccida A. & S.* is found on the leaves of *P. officinalis*, but is probably not confined to that species."

2407



2408



MAGNOLIA'CEÆ.

Magnolia grandiflora. Page 262. line 3., for "præ'cox *Andri*," read "præ'coce d'*Andry*."

l. 10., add: "In the nursery of M. Roy, at Angers, are 18 varieties, part of which do not appear to be in British gardens, and some of which, M. Roy informs us, are very much hardier than the species. (See *Gard. Mag.*, xiii. p. 21.) The Hon. and Rev. W. Herbert thinks it probable that some beautiful and hardy varieties may be raised by fertilising the seed of *M. grandiflora* with the pollen of *M. tripétala* and *M. conspicua*."

266. l. 25., after full stop, add: "In one of Drummond's letters to Sir W. J. Hooker, he states that *Epidéndrum conópseum* grows parasitically upon *M. grandiflora*, as well as on *Quercus virens* in South Florida, at Apalachicola. (See *Comp to Rot. Mag.*, i. p. 46.)"

last line, add: "At Desio, near Milan, it is 50 ft. high; diameter of the trunk 1 ft. 10 in., and of the head 30 ft."

M. glauca. 269. l. 4., for "that at Syon figured in our Second Volume," read "one at Syon 20 ft. high."

Statistics. 269. l. 13., for "Cowan," read "Conon."

M. tripétala. 270., to "Propagation and Culture," add: "Mr. Herbert suggests that, from its hardiness, it would be desirable to try to produce some hybrids between it and the more delicate Chinese species."

272. l. 12. after full stop, add: "It ripened seeds at Desio, near Milan, in 1835; and 150 young plants were raised from it in the spring of 1836; among which were some, from seed which had been fecundated with the pollen of *M. conspicua* and *M. purpurea*."

M. purpurea. 282., to the paragraph headed "Varieties," add: "A curious variety of this species has been raised at Desio, near Milan, by Signor Casoretti, the garden director there, which has all the characteristics of the species, but is only 1 ft. 6 in. high. Signor Casoretti calls this variety *M. obovata pumila*."

Liriodéndron Tulipifera. 289., after the paragraph headed "Propagation and Culture," add:—"The fungi found on the *Liriodéndron* are, *Lentius strigosus* Fr., *Polýporus gilvus* Schwein., *P. corticola* Fr., *Peziza Erimæci* Schwein., *Sphæria Liriodéndrus* Schwein., *S. subiculata* Schwein., *Ectostròma Liriodéndri* Fr., *Trichoderma globosum* Schwein.—*M. J. B.*"

ANONA'CEÆ.

Asimina. 293., after the paragraph headed "Geography, History, &c.," add: "The only fungus which is known to be found on plants of this genus is *Ectostròma Anonæ* Fr."

BERBERA'CEÆ.

299., add after the paragraph headed MAHO'NIA: "These genera contain all the ligneous species in the § *Berberidea*; but in the § *Nandina* is one half-hardy ligneous species, *Nandina domestica*."

Berberis vulgaris. 301., add "and our fig. 2409."

l. 29. *Varieties*, dele "B. v. 2 lutea," &c., it being the same as B. v. 8 *asperma*.

l. 34. for "*Kielm*," read "*Kalm*."

l. 16. from the bottom, after "B. v. 8 *asperma*," add "syn. B. v. lutea."

303., after the paragraph headed "Diseases, &c.," add: "Also to *Peziza Berberidis* Pers., *Sphæria destrusa* Fr., *S. Berberidis* Pers. (syn. *Cucurbitaria Berberidis* Grev., t. 84., and fig. 16384. in the *Encyclopædia of Plants*), and *S. epidérmidis* Fr., on the leaves. *Erysiphe penicillata* Schlect., which is found on the honeysuckle and the gooseberry, is also found on the common berberry.—*M. J. B.*"



B. empetrifolia. Page 306. line 21. from the top, for "Engraving," read "Engravings;" and add "Swt. Brit. Fl.-Gard., 2d ser., t. 350."

l. 23., after "(*Don's Mill.*, i. p. 117.)," add: "A low procumbent shrub, with slender, twiggy, angular branches, covered with a chestnut-coloured bark. Leaves fasciculate, linear, mucronate; revolute and entire at the margins; glaucous; about $\frac{1}{2}$ in. long, and nearly a line in breadth. Peduncles 1-flowered, solitary or in pairs, slender, filiform, often curved, as long as the leaves. Flowers rather large, spreading. Sepals elliptical, yellow. Petals orange, obovate, retuse, shorter than the sepals. Stamens 6, shorter than the petals, pale yellow. Ovarium elliptical, green. Stigma broad, peltate, sessile, yellow. A native of the Straits of Magellan, whence it was sent to the Clapton Nursery by Mr. Anderson, an indefatigable collector for that establishment, who accompanied Captain King in his voyage of survey. The plant was originally discovered by Commerson, and has been long known from the specimens collected by that botanist. The habit of the plant is extremely delicate; but its flowers are large, and of a rich orange colour. It is readily increased by layers. (*Brit. Fl.-Gard.*, 2d ser.)"

B. floribunda. 306. l. 36. after "Synonymes," add "*B. Lycium angustifolium* Royle."

B. asiatica. 306. l. 4. from the bottom, after "Synonymes," add "the *Lycium* of Dioscorides Royle in *Lin. Trans.*, xvii. p. 83., *Ann. des Scien. Nat.*, t. 2. p. 181."

307. l. 17., after "racemes," add: "The fruit of *B. asiatica* was formed, and of considerable size, at Syon, on July 20. 1837, when *B. aristata* was beautifully in flower, and with many of the flower buds not fully expanded. The fruit of *B. asiatica* was oblong, pinkish or purplish, wrinkled, and covered with a fine thick bloom, like the best table raisins. The flowers of *B. aristata* were of a brilliant yellow, and the plant was covered with them."

B. dealbata. 307. l. 33. after full stop, insert: "Mr. Gordon says that the fruit is of a yellowish purple; and adds that the flowers are sweet-scented, and the plant quite hardy."

Additional Species of Berberis. 308., add to the beginning of the paragraph: "*B. Coriaria* Wall. et Royle has been raised from seeds received from Dr. Wallich and Dr. Royle, in the Horticultural Society's Garden, and another species from Kamaon, both of which are quite hardy."

308. l. 38., after "p. 306.," add: "Mr. Gordon informs us that there are plants of *B. buxifolia* in some of the London nurseries, from which it appears to be very nearly related to *B. dulcis*. It is the true *B. provinciâlis* of the French."

Mahonia. 309., add to the first paragraph: "*Sphæria æquilinearis* Schwein. occurs on some of the species."

M. fasciculâris. 309. l. 16. from the bottom, after "distinguished," insert "even."

l. 15. ditto, insert a comma after "distance."

M. repens. 311. l. 27., for "but these have not yet been succeeded by fruit," read "and, like *M. Aquifolium*, it ripens seeds freely. The seeds should be sown in a cold-pit, as soon as they are ripe, and they will come up the following spring."

§ *Nandina*. Add as a paragraph at bottom of page.

"*Nandina domestica* Thunb. Nov. Gen., l. p. 14., Bot. Mag., t. 1109., and our fig. 2410., is an elegant evergreen shrub, growing to the height of 5 ft. The flowers are white, with yellow anthers; and the berries, which are about the size of a pea, are red. It is a native of China and Japan, whence it was brought to England in 1804, and is now not uncommon in British green-houses."



2410

CRUCIACEÆ.

Cheiranthus Cheiri fruticosus. Page 313. line 7., after "wallflower," add
" (the leaves of which are sometimes spotted with *Macrosporium*
Cheiranthi Fr.)"

Iberis sempervirens. 313. l. 11., after the full stop, add : " A plant of *I. sempervirens*, in the Trinity College Botanic Garden, Dublin, which was planted out in 1809, had, in 1837, attained the height of 3 ft. in the centre, and formed a hemispherical tuft, which, if it had not been constantly cut in every year, would have been several yards in diameter. It flowers in the month of May, and, at that season, resembles a heap of snow."

CISTACEÆ.

317. l. 15., after the full stop, add : " *Antennaria cistophila Fr.* is found on the leaves of some of the species."

Cistus latifolius. 327. l. 22., add : " There is a plant of this *Cistus* in the Horticultural Society's Garden."

Helianthemum umbellatum. 329. last line, add : " There are plants in the Horticultural Society's Garden, raised from seeds collected near Paris."

POLYGALACEÆ.

Polygala Chamæbixus. 356. l. 9., after "Switzerland," add : " On the limestone rocks, on the road from Zurich to Zug, it is very fine and abundant." After "rocky situations," add "generally."

MALVACEÆ.

Hibiscus syriacus. 362. l. 2., from the bottom, after full stop, add : " *Sphæria Hibisci Schwein.* is found on the leaves."

363. before App. I., add : " *Málva Munroana D. Don, Bot. Reg.*, t. 1306., and our *fig. 2411.*, is a hardy suffruticose plant, from 1 ft. to 2 ft. high, a native of Columbia, introduced into England in 1828, and producing its scarlet flowers from May to October."

TILIACEÆ.

Tilia. 364. l. 17., add to "Derivation :—" " The French derive their name *tilleul* from *tailler* ; either because the tree bears pruning well, or because the wood may be easily carved into any required form. The ancient German name of *bast holz*, literally bark wood, is evidently derived from the use made of the bark of the lime in forming mats."

l. 25., add to "Gen. Char., &c.," after the full stop : " Host, in his *Flora Aust.*, has described 14 species ; viz., *T. vitifolia*, *T. corylifolia*, *T. grandifolia Sm.*, *T. corallina* (syn. *T. europæa Hook. Lond.*), *T. mutabilis*, *T. latibracteata*, *T. præcox*, *T. pyramidalis*, *T. intermedia*, *T. tenuifolia*, *T. obliqua*, *T. europæa Sm.*, *T. parvifolia Sm.*, *T. argentea* (syn. *alba Wald. et Ku.*, icon., t. 3.). Host also observes that he has always found the calyx 6-sepaled, and the corolla 12-petaled."

T. europæa. 366., before the paragraph headed "Properties and Uses," insert : —

" *Remarkable Trees.* In the middle ages, during the struggles of the Swiss and Flemish people to recover their liberty, it was their custom to plant a lime tree on the field of every battle that they gained over their oppressors ; and many of these trees, particularly those planted by the Swiss in commemoration of their victories over Charles the Bold, are still remaining (see p. 162.), and have been the theme of many ballads.

" Evelyn, in his *Sylva*, mentions some large lime trees 'at Basil, and that a

2411



Augsburg, under whose prodigious shade they so often feast and celebrate their weddings; because they are all of them noted for their reverend antiquity; that of Basil branching out one hundred paces in diameter from a stem of about 20 ft. in circle, under which the German emperors have sometimes eaten; and to such trees, it seems, they paid divine honours, as the nearest emblems of eternity.' (*Hunt. Evel.*, ii. p. 180.) At Neustadt, in Wirtemberg, there is a prodigious lime tree, which gives its name to the town, that being called Neustadt an der Linden. This tree is said by Evelyn to have had, in his time, a trunk above 27 ft. in circumference, and the diameter of the space covered by its branches to have been 403 ft. It was 'set about with divers columns and monuments of stone (82 in number, and formerly above 100 more), which several princes and noble persons have adorned, and which, as so many pillars, serve likewise to support the umbrageous and venerable boughs; and that even the tree had been much ampler, the ruins and distances of the columns declare, which the rude soldiers have greatly impaired.' (*Ibid.*, p. 187.) Evelyn adds copies of many of the inscriptions on the columns, the oldest of which is dated 1550; and the column on which it is inscribed supports one of the largest limbs, at a considerable distance from the tree, which must thus have been of enormous size nearly three hundred years ago. In the wars which afterwards desolated the country, this lime tree suffered severely; and Gilpin tells us that its limbs were mangled in wantonness by the troops besieging Neustadt. This tree is still (1838) in existence; and, by a drawing of it made for us in 1837, by M. Abresch, a young German artist, we find that its trunk is now 18 ft. in diameter, and is surrounded by a balustrade of wood raised on a low wall coped with stone; and that its limbs are supported on 108 columns. The people of Neustadt are in the habit of sitting in this tree to eat fruit, &c.; and several gooseberry bushes have sprung up in the crevices and hollows of the bark, the fruit of which is sold to visitors.

"Evelyn mentions another remarkable lime at Cleves, cut in eight sides, supported on pillars, and having a room in the middle of the tree; and another at Tillburg, near Buda, in Hungary, growing in the middle of the street, and having its branches supported by 28 columns. Besides these trees, he notices 'the famous tilia of Zurich;' and 'the linden of Schalouse, in Swisse, under which is a bower, composed of its branches, capable of containing 300 persons sitting at ease: it has a fountain set about with many tables, formed only of the boughs, to which they ascend by steps, all kept so accurately, and so very thick, that the sun never looks into it.' (*Ibid.*) In Evelyn's *Diary*, he tells us that, in the year 1641, in the cloister garden of the Convent of St. Clara, at Bois le Duc, there was an overgrown lime tree, out of the stem of which, near the root, 'issued five upright exceedingly tall suckers, or boles, the like whereof, for evenness and height, were never observed.' (*Diary*, &c., 8vo edit., i. p. 39.) 'An extraordinary and stately tilia, linden, or lime tree, there groweth at Depeham, in Norfolk, ten miles from Norwich, whose measure is this:—The compass, in the least part of the trunk or body, at about 6 ft. from the ground, is 26 ft.; near the ground, 46 feet; and at 3 ft., 36 ft. The height is about 90 ft.' (*Ibid.*)

"In the cemetery of the hospital at Annaberg, in Saxony, is a very old lime tree, with enormous branches. The planter of this tree, who is buried under its shade, left a sum of money to have a sermon preached every Trinity Sunday under it. This tree is of enormous size, and is said, when young, to have been planted with its head downwards, and root upwards.

"In Prussia, near Königsberg, are two large lime trees growing closely together on a grassy bank. The legend is, that beneath these trees are buried, a bride who died on her wedding day, and her husband, who did not long survive her loss, both lying in one grave. This tree is a favourite trysting-place for lovers. In the churchyard at Seidlitz, in Bohemia, are some old lime trees, the leaves of which are hooded; and the peasants affirm that they have been so ever since some monks from a neighbouring convent were hanged on the

boughs. The principal street in Berlin is called *Unter den Linden*, from its being planted with an avenue of lime trees. The name of Linnæus is taken from an ancient lime tree, of great magnitude, which grew near his dwelling; *linn* being the Swedish name of the lime.

"In England are many old limes, the tree having been anciently much planted in towns; because its odour was considered to purify the air, and to be good against epilepsy.

"*Poetical and mythological Allusions.* Theophrastus, Homer, Horace, Virgil, Columella, and Pliny mention the lime tree, and celebrate its bark and wood; and Ovid tells us that Baucis, when Jupiter and Mercury, after they had partaken of her hospitality, offered to grant any request she might make, only asked to die on the same day as her husband; and that the gods, granting her prayer, when she and Philemon had both attained a good old age, she was changed into a lime tree, and her husband into an oak. Ovid adds that, while the transformation was taking place, they continued speaking affectionately to each other, till the bark had quite closed round them; and that, even when they had become trees, they entwined their branches closely together. (*Ovid. Met.*, lib. viii. v. 631., &c.)

"Among the British poets, Cowley says,—

———— 'The bee
Sits on the bloom, extracting liquid sweets
Deliciously.'

"And Cowper speaks of the lime,—

———— 'At dewy eve
Diffusing odours.'

"Mrs. Howitt says:—

'Above waves wide the linden tree;
With humming bees the air is thrill'd;
And through the sleeping bush is heard
The sudden voice of the woodland bird,
Like a sound with which a dream is fill'd.'

Page 368. l. 17. from the bottom, after "wood," insert: "The celebrated sculptor, Gibbons, always used the wood of this tree for his inimitable carvings of flowers, fruit, dead game, &c."

371. Before the paragraph headed "*Statistics*," insert:—

"*The Fungi* on the lime are, *Clavaria Ardènia* Sow., which is also found on the hazel; *Crinula caliciformis* Fr., *Peziza filiiæ* Fr., *P. stipitata* Fr., which is also found on the beech; *Tremella disciformis* Fr., *Exidia truncata* Fr., *Sphæria leprosa* Pers., *S. velata* Pers., *S. pusilla* Pers., *S. aurora* Fr., *S. acinosa* Fr., *S. tephrotricha* Fr., *S. Tiliæ* Pers., and *S. melanostyla* Dec., on the leaves. *Cytispora carphosperma* Fr., which is also found on the apple tree; *Asteroma Tiliæ Rudolphi*, *Ectostroma Tiliæ* Fr., on the leaves; and *Helminthosporium Tiliæ* Fr., syn. *Exosporium Tiliæ Grev.*, t. 206. One or two *Erinea* are found on the leaves; but mycologists in general are of opinion that they are mere anamorphoses of the cellular tissue. — *M. J. B.*"

372. l. 6., for "Linde," read "Linden."

Other Species belonging to the order Tiliaceæ. Græwia occidentalis. 376. l. 28., after "*Bot. Mag.*, t. 422.," add "and our fig. 2412."

TERNSTRÖMIA'CEÆ.

Gordonia. 379. l. 1., for "Alexander," read "James."

Camellia reticulata. 389., add to list of *Engravings*, "and our fig. 2413."

AURANTIA'CEÆ.

396. l. 21., after the full stop, add: "The leaves of orange and lemon trees are often covered with *Cladosporium Fumago* Lk.; and the fruit is attacked by several kinds of mould, one of which is peculiar to it: *Oidium fasciculatum* Berk., first described by Dr. Greville, in the *Flora Edinensis*. There is a very interesting paper in the *Zoological Journal*, iv. p. 475., on an insect, *Ceratitis citripèda*, which is very destructive to oranges. — *M. J. B.*"



HYPERICA'CEE.

Page 397. line 18., after the full stop, add : " On the leaves of plants of this order are found *Urredo Hypericorum*, and *Æcidium Hypèrici frondosè Schwein.*"

398., dele the whole of "*Hypèricum foliosum*," it being a syn. of *H. Kalmianum*.

H. canariense. 399., add to list of *Engravings*, "and our *fig.* 2414."

H. chinense. 399., to "*Synonymes*," add "? *H. nepalense Hort.*"

H. Kalmianum. 400. l. 3., after semicolon, add "*H. foliosum Ait. Hort. Kew.*, ed. 1., iii. p. 104.; shining St. John's Wort."



2414



2415

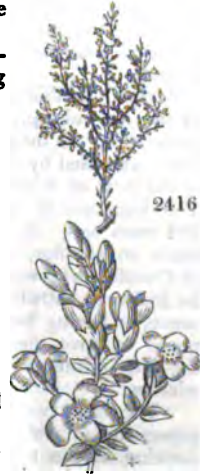

2416

H. prolificum. 401., add to list of *Engravings*, "and our *fig.* 2415."

H. aegyptiacum. 401., add to list of *Engravings*, "and our *fig.* 2416."

403., at the end of the paragraph headed "*Other Species of Hypericum*," add : "There is a plant entitled *H. nepalense* in the Horticultural Society's Garden, and another at Flitwick."

ACERA'CEE.

Fungi. 405. l. 6., add as a paragraph : "The principal fungi found on the genus *Acer* are, *Thelèphora acérina Pers.*, which also occurs on the beech; *Peziza Plátani Pers.*, on the leaves of *Acer platanoides*; *Sphæria incrústans Pers.*, also sometimes found on the poplar; *S. hystrix Tode*, *S. subtécta Fr.*, and *S. dioica*, found on the sycamore; *S. pugillus Schwein.*; *S. scutellàta Pers.*, found also on the alder; *S. protracta Pers.*, on the common maple; *S. pàpula Schwein.*; *S. inquinans Tode*; *S. acericola Duby*; *Rhytisma punctàtum Fr.*, on the leaves; *Phacidium acérinum Fr.*; *Erysiphe bicórnis Lk.*, and *Puccinia Acerum Lk.*, on the leaves; *Myxotrichum mollè Fr.*; *Volu-tèlla pallens Fr.*; and *Corynèum umbonàtum Nces.* — *M. J. B.*"

Acer oblongum. 405. last line from the bottom, add "and our *figs.* 2417. and 2418."

A. *Pseudo-Platanus. Varieties.* 415., dele the paragraph beginning "A. P. 6 *laciniata.*"

417., add to the paragraph headed "History."

"The most remarkable sycamores in Scotland are those which are called dool trees. These trees were used by the powerful barons in the west of



Scotland, for hanging their enemies and refractory vassals on, and were for this reason called dool, or grief, trees. There are three very large trees of this description still standing in Ayrshire, all of which formerly belonged to the powerful family of the Kennedys, from whom the present Marquess of Ailsa is descended.



One of these trees stands near the fine old castle of Cassilis, one of the seats of the Marquess of Ailsa, on the banks of the river Doon. It is a noble-looking spreading tree, with a head above 190 ft. in circumference; and is raised on a pyramid composed of six steps, covered with turf. The last time this tree was used as a gibbet was for the execution of Johnny Faa, the gipsy, and seven of his men, who, the legend says, in the old Scotch song of Johnny Faa, were hanged on this tree for running away with the Countess of Cassilis. Through the kindness of the Marquess of Ailsa, we have, however, been favoured with a drawing of the tree, the following account of it, and the legend.

"The Cassillis dule, or dool, tree, is not so remarkable for its girt of stem as for its wide-spreading branches and luxuriant foliage: in its branches, from 20 to 30 men could be easily concealed. This tree, like other dool trees, was used by the family of Kennedy, who were the most powerful barons of the west of Scotland, for hanging their enemies and refractory vassals on. The last time it was used for such purposes is said to have been about 200 years ago, when Sir John Fau of Dunbar was hanged on it, for having made an attempt, in the disguise of a gipsy, to carry off the then Countess of Cassillis, who was the daughter of the Earl of Haddington, and to whom he had been betrothed prior to his going abroad to travel; but, in his absence, he having been detained for some years a prisoner in Spain, and supposed to have died, the lady married John Earl of Cassillis. It is said that the lady witnessed the execution of her former lover from her bedroom window."

"The other two dool trees are on the estate of Blairquhan, now in the possession of Sir David Hunter Blair, who has kindly favoured us with a drawing of the trees, and the following particulars respecting them. The largest is 72 ft. high, with a trunk 17 ft. in circumference at 10 ft. from the ground; the other is somewhat less.

"They are in great health and vigour, and are probably nearly three centuries old. The date on the old coat of arms of the Kennedys, in the adjoining court of the castle, is 1573."

"Besides these dool trees, there is another remarkable sycamore in the west of Scotland, which grows out of the wall of Sweetheart Abbey, near Dumfries. This tree consists of two large limbs, being divided near the root by a stone, the largest of which is 21 ft. high above the wall. The tree is covered with woodbine, and has a beautiful and very singular appearance."

A. *campéstre.* 429., add to "Varieties:"

"† A. c. 5 *lavigatum* Hort. has the leaves smoother than the species. There are plants in the Horticultural Society's Garden, and in the arboretum of Messrs. Loddiges.

"■ A. c. 6 *natum* Hort.— There are plants in the Horticultural Society's Garden."

Before the paragraph headed "Soil, Situation, &c.," insert:—

"Poetical Allusions. Maple dishes are frequently mentioned by the Latin

poets, and Virgil represents Æneas seated on a trunk of maple for a throne.

“ ‘ On sods of turf he set the soldiers round ;
A maple throne, raised higher from the ground,
Received the Trojan chief ; and o'er the bed
A lion's shaggy hide for ornament they spread .”

“ Cowper, and many modern poets, also mention the maple bowls of shepherds and hermits.”

Doubtful Species of A'cer. Page 431., at the end of the paragraph, add : “ We are informed by Mr. Gordon that there is a plant of *A. lobatum* in the Horticultural Society's Garden, which was received from M. Fischer of Göttingen, and which is the same as the *A. hybridum* in the collection of Messrs Loddiges.”

Anticipated Species of A'cer. *A. ibericum.* 431., add to the paragraph : “ There are plants under this name in the Horticultural Society's Garden, both imported and raised from seed, which, Mr. Gordon thinks, strongly resemble *A. lobatum*.”

A. lævigatum. 431., add to the paragraph : “ This is a totally different plant from the *A. lævigatum* in the arboretum of Messrs. Loddiges, which is a variety of *A. campêtre*.”

A. villòsum. 431., add to the paragraph : “ *A. villòsum Presl* is mentioned in the *Companion to the Botanical Magazine*, as being found with *A. monspessulanum* on Mount Etna ; but, as it is said to be peculiar to that mountain, it must be a different plant from the *A. villòsum* of Dr. Wallich.”

Negúndo. 460., add to “ *Varieties* : ” “ † N. f. 3 *violàcea* Booth.”

461., to the paragraph headed “ *Soil, Situation, &c.*,” add : “ The only fungus found on the *Negúndo* is *Leptostroma scriptum Fr.*”

ÆSCULA'CEÆ.

Æ'sculus. 643., after the paragraph headed “ *Description*,” add : “ The fungi found on trees of this order are, *Cryptosporium Æ'sculi Fr.* ; *Sphæ'ria æsculicola Fr.*, on dead leaves ; and *Polýporus Æ'sculi Schwein.*, on *Pàvia flàva Fr.* — *M. J. B.*”

Æ. Hippocástanum. 463., to the “ *Varieties*,” add : —

“ † *Æ. H. 4 foliis argenteis.* There is a plant in the Horticultural Society's Garden, the leaves of which are blotched or striped with white, instead of yellow.”

Æ. (H.) ohien'sis. 467. l. 9., for “ inferior,” read “ superior ; ” and add after the full stop : “ It has fine large leaves, of a bright green, and quite white flowers.”

Æ. (H.) rubicúnda. 467. l. 23., after “ *Lindl.*” add : “ *Æ. rósea* differs slightly from *Æ. rubicúnda* both in flowers and foliage, but not sufficiently to constitute it a variety.”

468., dele the paragraph beginning “ † 6. *Æ. (H.) Lyo'nii.*”

Pàvia híbrida. 472. l. 22. from the bottom, for “ flowers variegated with yellow, white, and purple,” read “ flowers yellow.”

P. macrostàcha. 474. first line, for “ 1820,” read “ 1786, by Mr. John Fraser.”

Statistics. Add to the end of the paragraph : “ Probably the largest tree of this species in England is one at the Vicarage at Rickmansworth, which is 16 ft. high, and covers a space of 29 square yards. It stands within a few yards of a rivulet, in a dark porous soil, on a bed of fine gravel, about 2 ft. below the surface, which evidently suits it very well.”

Other Varieties of Pàvia. 474., l. 14. from the bottom, after the full stop, add : “ Mr. Gordon informs us that the tree in the Horticultural Society's Garden, marked there *Æ'sculus Lyònä*, is a *Pàvia.*”

VITA'CEE.

Ampelopsis (h.) *hirsuta*. Page 482., after the paragraph headed "*Spec. Char., &c.*," add: "There is a plant of this kind in the Horticultural Society's Garden which retains its leaves much longer than *A. hederacea*; and they do not die off scarlet."

RUTA'CEE.

Ruta graveolens. 486. last line, add: "The fungus *Dothidea Ruta Mont.* is found on the leaves."

Half-hardy Species of Ruta. 487., add to the paragraph: "There are plants of *R. chalepensis* in the Horticultural Society's Garden, from the south of Europe, which are much stronger scented than the common rue."

Add before Chap. XXX. :—

"App. I. *Half-hardy Species of Rutaceæ.*

"*Correa álba* Smith in Linn. Trans., iv. p. 219., Vent. Malm., t. 13., Andr. Bot. Rep., t. 18., and our fig. 2419.; *C. cotinifolia* Sal. Par. Lond., t. 100.; has the corolla white, and the leaves white, or rufous above, and rather whitish beneath. A showy flowering shrub, growing to the height of 10 ft., a native of New South Wales, introduced in 1793, and flowering from April to July.

"*C. a. 2 rotundifolia* Dec. Prod., i. p. 719., Don's Mill., i. p. 790.; *C.*



2420

2421

rufa Vent. Malm., t. 13. No. 2.; has the leaves somewhat rounder than the species.

"*Crudea saligna* Smith in Linn. Trans., iv. p. 220., Vent. Malm., t. 7., Sims Bot. Mag., t. 989., Andr. Bot. Rep., t. 79., and our fig. 2420. is a well-known green-house shrub, with beautiful pale purple or purplish flowers, and willow-like leaves. It is a native of New South Wales, whence it was introduced in 1790. It flowers from July to December.

"*Boronia serrulata* Smith in Linn. Trans., viii. p. 284., Bot. Reg., t. 842., Lodd. Bot. Cab., t. 998., Swt. Fl. Aus. t. 19., and our figs. 2421. and 2422. A very beautiful shrub, growing to the height of from 1 ft. to 6 ft., with deep rose-coloured and very fragrant flowers; and trapeziform, acute, slightly serrulated leaves, which are smooth and full of glandular dots. It is a native of Port Jackson, in New Holland, whence it was brought to England in 1816. It flowers in June and July."



2422

XANTHOXYLA'CEE.

Ptelea trifoliata. *Varieties*. 489., in the paragraph beginning "*P. t. 2 pentu-*

phylla," for "Munchh. Hans.," read "Munch. Haus.;" and, after the full stop, add: "There is a plant in the Horticultural Society's Garden, the leaves of which vary from 3 to 5 in number."

CORIACEÆ.

- Coriaria myrsifolia*. Page 493., add to the first paragraph: "The fungus *Dothidea Coriariæ* Mont. is found on this species."
C. microphylla. 593., add: "There was a plant under the name of *Coriaria sarmentosa* in the arboretum of Messrs. Loddiges in August, 1836."

CELASTRACEÆ.

- Euonymus europæus*. 497., add to the paragraph headed "*Casualties*:" "The following fungi are found upon this species: *Sphæria Euonymi* Kz. *S. foveolaris* Fr., *Perisporium alienum* Fr., and *Urredo Ribesii* Lk.; the last being also found on some species of *Ribes*. — M. J. B."
E. sarmentosus. 500., add to the paragraph headed "*Spec. Char.*:" "There were plants at Messrs. Loddiges's under the name of *E. scandens*, in August, 1836."
E. garciniaefolius. 501., in the last line of the paragraph headed "*Spec. Char., &c.*," for "but we have not seen plants of it," read "there were plants of it in the Horticultural Society's Garden in August, 1836."
E. grandiflorus. 501., in the last two lines of the paragraph headed "*Spec. Char., &c.*," for "This very desirable species has not yet been introduced," read "This species was introduced in 1824;" and add: —

"*E. caucasicum* Lodd. Cat., and our fig. 2423.; ? *E. nana* Bieb. There is a plant in the arboretum of Messrs. Loddiges, from which our figure was taken."



- E. japonicus*. 501., after "Thunb.," add, "and our fig. 2425.;" and at the end of the paragraph insert, "There are plants in the Horticultural Society's Garden of this species, and a variety with variegated leaves, both of which stand out with a little protection."

Celastrus scandens. 502. l. 22. from the bottom, after "cultivated," insert: "*Sphæria Celastri* Schwein. is found on this plant."

Before the paragraph headed "*Half-hardy Species of Celastrus*," insert:—

"*C. nepalensis* and *C. pyracanthaefolia* were in Messrs. Loddiges's arboretum in August, 1836."

Nemopanthes canadensis. 503., to the list of *Engravings*, add: "and our fig. 2424."



AQUIFOLIAEÆ.

- Ilex Aquifolium*. Page 509., add to "*Varieties*:" —
 " ? L. A. 24 *fructu nigro* Host. *The black-fruited common Holly*.—There are plants of this variety at Messrs. Loddiges's."
 515., before the paragraph headed "*Statistics*," insert:—

"*Fungi. Agaricus Hudsoni* Pers., syn. *A. pilosus* Sow., on the leaves; *Sphæria Aquifolii* Fr., and *S. insculpta* Fr., on the bark; and *S. Illicis* Schll., *S. ilicincola*, *Stègia Illicis* Fr., syn. *Xyloma concavum* Grev., and *Ceuthospora phacidioides* Grev., on the leaves. — *M. J. B.*"

Page 509. line 31. from the bottom, insert: "In Suffolk, at Stutton Rectory, there is a holly 90 years planted, with a trunk 3 ft. 9 in. in diameter."

I. balcàrica. 516., add to the list of *Engravings*: "and our fig. 2426."

519., before App. i., insert:—

"† *I. magellànica* Lodd. Cat., 1836. There are plants of this species in the arboretum of Messrs. Loddiges, and in the Horticultural Society's Garden."

Prinos deciduus. 521. l. 6., add to the end of the paragraph: "*Sphæria friabilis* Pers. is found on the bark; and *Rhytisma ilicincola* Fr., and *R. velatum* Fr., on the leaves. — *M. J. B.*"

P. verticillatus. 521. l. 7. from the bottom, after the full stop, add: "*Rhytisma Prini* Fr. is found on this species."

P. glàber. 522, in the line headed "*Engraving*," for "The figure," &c., substitute "and our fig. 2428."

P. coriàceus. 523., to the paragraph headed "*Engravings*," add: "and our fig. 2427."



2426



2427



2428

RHAMNACEÆ.

Zizyphus sinensis. 525. last two lines, for "and we have never seen it," read "there is a plant in the Horticultural Society's Garden."

Z. Jùjuba. 527., add to the paragraph: "*Fig.*

2429. shows the leaves, fruit of different shapes, and stones (the last of the natural size), of *Zizyphus Jùjuba*, taken from Hooker's *Journal of Botany*, 2d ser., t. 140. In the account of this species given in the *Journal of Botany*, vol. i. p. 320., by M. L. Bouton, Vice-Secretary of the Natural History Society of the Mauritius, it is stated, that the *Zizyphus Jùjuba*, which is known in the island by the name of *Masson*, grows there to the height of about 25 ft. or 30 ft. There are a number of different varieties, which he divides into two sections, viz. those with flesh adhering to the nut,

and those with flesh that does not adhere. The colour of the fruit, when ripe, is a greenish yellow in some varieties, and a reddish brown in others. *Z. mauritiana* and *Z. rotundata* Dec. Prod., M. Bouton considers to be only two of the varieties which he has described. The different forms of the fruit are shown in the engraving from which our figure is copied; as are the two forms of the stones, or nuts, which are



2429

given of the natural size, though the fruit is to our usual scale. The different varieties flower after the rains in the months of January and February; and the fruits ripen in June and July, continuing to hang on the tree till the beginning of September. *Z. Tujuba* is not indigenous to the Mauritius, but has been long cultivated almost all over the island."

Paliurus. Page 528., after the paragraph headed "*Statistics*," insert:—

"■ 2. *P. VIRGA'TUS* D. Don. The twiggy Christ's Thorn.

Identification. D. Don in *Bot. Mag.*, t. 2535.; *Fl. Nep.*, 189.; G. Don's

Miller, 2. p. 23.

Engravings. *Bot. Mag.*, t. 2535.; and our *fig.* 2430.

2430

Spec. Char., &c. Branches smooth. Leaves obliquely cordate or elliptical, 3-nerved, shining; wing of fruit entire. (*Don*.) A beautiful, hardy, deciduous shrub, growing to the height of 10 ft.; with serrulated leaves, each of which has two thorns at its base, one straight and the other hooked. The flowers, which are produced in July and August, are of a greenish yellow, and in axillary corymbs. It is a native of Nepal, whence it was brought to Britain in 1819; and there is a very handsome plant of it in the Chelsea Botanic Garden, which, in 1836, was 10 ft. high."



Rhámnus. 529., add to the paragraph headed "*Description, &c.*:" "*The fungi found on the plants belonging to this order are: Týmpanis Frángula Fr., Sphæria punicea Schmidt, S. Rhámni Nees, S. rhodostoma H. et S., on R. Frángula; S. núcula Fr., on R. alpina; Múcor nigréscens Schum., Æcidium crássum Pers., Æ. Rhámni Pers.—M. J. B.*"

R. híbridus. 531. l. 28., after the full stop, add: "There is also a plant in the arboretum of Messrs. Loddiges, under the name of *R. burgundi-acus*."

R. Erythróxylon. 534., in the list of *Engravings*, for "t. 62.," read "t. 63.," and for "our *fig.* 204.," read "our *fig.* 205."

R. E. angustissimum. 535., for "(*fig.* 205.)," read "(*fig.* 204.);" and add: "There are plants of this variety in the Horticultural Society's Garden."

R. persicifólius. 538., dele the whole paragraph, and substitute:—

"*R. persicifólius* Bert., *Moris*. *Stirp. Sard.*, f. 2., we are informed by Signor Manetti, is an erect shrub, from 10 ft. to 12 ft. high, with lanceolate minutely crenated leaves, pubescent on the under side, and on long petioles; calyx free. It is a native of Sardinia, where it flowers in March and April."

538., after the paragraph beginning "*R. tenuifólius*," near the bottom, add:—

"*R. glandulósus* Host. An evergreen shrub, of which a plant has stood out against a wall, in the Horticultural Society's Garden, since 1830."

Ceanóthus axúreus. 539., add to the paragraph headed "*Spec. Char., &c.*:" "There is a variety with white flowers in the Horticultural Society's Garden."

C. intermédus. 540., add to the paragraph headed "*Spec. Char., &c.*:" "There are plants of this species in the Horticultural Society's Garden, raised from seeds sent there by the late Mr. Fischer of Göttingen."

540., before "App. i. *Other Species of Ceanóthus*," insert:—

■ 8. *C. COLLI'NA* Doug. The Hill-side Ceanothus.

Identification. Doug. in *MSS*; *Fl. Cab.*, t. 13.

Engravings. *Fl. Cab.*, l. t. 13.; and our *fig.* 2431.

Spec. Char., &c. Branches decumbent, round, and smoothish; leaves ovate or elliptic, somewhat clammy, glandular-serrated; upper surface shining, under surface covered with adpressed hairs, 3-nerved; stipules awl-shaped; panicles axillary. (*Knowles and Westcott*.) This is a low decumbent shrub, scarcely rising a foot from the ground; it is a hardy evergreen, and produces its white flowers in great abundance. It is a native of North

America, whence the seeds were sent home by the unfortunate Douglas in 1827; and those sown in the London Horticultural Society's Garden did not vegetate. Seeds were, however, distributed; and of those sent to Messrs. Pope and Co. of the Handsworth Nursery, near Birmingham, one germinated, and produced the plant figured in the *Floral Cabinet*. This species has not yet borne seeds in England; but it has been abundantly increased by layers, which strike readily."

Collètia. Page 541., after the paragraph headed "*Collètia*," insert: "*C. hórrida* Willd. (fig. 2433. c) appears somewhat different from *C. spinósa* (fig. 217. p. 541.); and both it and *C. ulcina* Gil. (fig. 2432. a) are evergreen shrubs, which are found as hardy as the common furze in the arboretum of Messrs. Loddiges."

Retanilla. 541., in the last line but one of the paragraph headed "*Retanilla*," after t. 16., add: "and our figure *b* in fig. 2432."

Pomaderris. 542., to the paragraph headed "*Pomaderris*," add: "*P. plumósa* has stood out for several years in Devonshire. *P. prunifolia* also



stands out; and, though it is sometimes killed down to the ground, it springs again from the root."

ANACARDIACEÆ.

Pistácia. 545., to the paragraph headed "*Gen. Char.*," add: "The fungus *Urèdo Terebinthi* Dec. is found on the leaves of plants of this genus."

Rhús. 549., to the paragraph headed "*Gen. Char.*," add: "The following fungi are found on plants of this genus:—*Hýdnum Rhòis* Schwein., *Sphæria Rhòis* Schwein.; *S. quaternata* Pers., on *R. glabra*; *S. sub-solitaria* Schwein., *Cytispora rhòina* Fr., *Dothidea Rhòis* Fr.; *Helminthosporium rigidum* Fr., on *R. radicans*.—*M. J. B.*"

557. head line, for "*Duvaúa*," read "*Rhús*."

R. suaveolens. 557., dele the entire paragraph.

R. aromática. 557., add after the line headed "*Engraving*:"—

"*Synonymæ*. *R. suaveolens* *Att. Hort. Kew.*, 1. p. 368., *Dec. Prod.*, 2. p. 72.; *Myrica trifoliata* *Hort.*; *Toxicodéndron crenatum* *Müll. Dict.*, No. 5."

557., before the last paragraph, three lines from the bottom, add:—

"† *R. caústica* Hook., *Láurus caústica* Mol., is an evergreen tree, a native of Chili, introduced in 1828, of which there are plants in the Horticultural Society's Garden. There are also plants under the same name in the Horticultural Society's Garden, raised from seeds sent by Dr. Wallich from the Snowy Mountains of Nepal."

Duvaia ovata. Page 559., add to list of *Engravings*: "and our *fig.* 2433."



LEGUMINO'SÆ.

Sect. I. SOPHORÆÆ.

Sophora. p. 565., in the paragraph headed "*Statistics*," after "In Austria," add: "At Schönbrunn, it is 48 ft. high, and the diameter of the head 55 ft. It flowers abundantly every year."

567., before App. i., introduce:—

"*Baptisia tinctoria* R. Br., and our *fig.* 2434., is a suffruticose plant, with yellow flowers; a native of North America, introduced in 1750."

Add to *Half-hardy Sophorææ*:—

"*Anagyris foetida* Lin. Spec., 534., Lodd. Cat., 740., and our *fig.* 2435., is a shrub from 6 ft. to 8 ft. high, a native of the south of Europe. It was introduced in 1570, and requires a slight protection during winter. It is fetid in every part when bruised.

"*A. f.* 2 *glauca* Dec. Prod. 2. p. 99., has the leaves more glaucous than those of the species.

"*A. latifolia* Willd. Enum., 489., has the leaflets broad and obtuse. It is a shrub about 10 ft. high, a native of Teneriffe, where it was introduced in 1815." *Brachysema latifolium*. 568., turn the cut *fig.* 247.

Sect. II. LOTÆÆ.

Ulex. 571., add to "*Varieties*:"—

"*Other Varieties*. Sir George Head, in the continuation of his *Home Tour*, observes:—"I also remarked the unusual stature of the furze plants in the hedge that crowns the summit, the spring shoots being, everywhere in the Isle of Man, more like those of a young fir tree, than of an ordinary plant. A dwarf species called Manx furze grows on the hills in a compact matted mass, that spreads like thick moss over several acres of ground in a plot; and is so springy that a man may walk without much difficulty across the surface, although at every step he may sink in up to his knees, the plant, pressed by his foot to the earth, by its elastic reaction rises again immediately, unbroken. Both sorts are used in winter as provender for cattle, the thorns being previously crushed by a machine adapted for the purpose, which implements, of simple construction, are merely a pair of wooden mallets worked by a small water wheel. Of these there are many among the streamlets in the mountains." (*Head's Continuation of Home Tour*, p. 82.)"

The Use of Furze for Hedges. 573., add:—

"Sir George Head, speaking of Guernsey, observes: 'A high mound of earth, surmounted by a strong furze hedge, is the usual fence of the country, therefore the premises of a Guernsey farmer are as impregnably fortified and

secured, as if he were the owner of an estate and farm surrounded by a high stone wall.' (*Head's Continuation of Home Tour*, p. 171.)"

Page 574., after the last paragraph, introduce:—

"*Fungi*. *Polyporus lentus Berk.*, and *Sphaeria elongata Fr.*, syn. *Cucurbitaria elongata Grev.*, t. 195.; the last being found on all the Leguminosæ. —*M. J. B.*"

Spartium juncum. 576., add to "*Varieties*,"—

"*S. j. 3 odoratissimum* D. Don in *Swt. Brit. Fl. Gard.* 2 ser., t. 390., and our *fig. 2436.*, is distinguished from the species by its more slender and spreading habit, its more silky leaves and shoots, and its smaller and more fragrant flowers. It was raised by the Rev. — Duke, of Lake House, near Salisbury, from seeds stated to have been received from Persia."

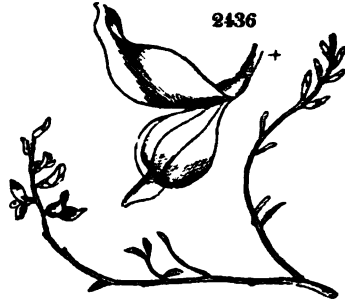

577., before Genus VII. introduce:

"*S. acutifolium* Lindl. in *Bot. Reg.* There are plants under this name in the Horticultural Society's Garden, which were raised from Turkish seeds; and the flowers of which are very fragrant. Dr. Lindley doubts whether this plant may not be a variety of *S. juncum*. He describes it as having longer and taper-pointed leaves, laxer racemes, and a more graceful habit of growth. It is probably the same as the *S. j. odoratissimum* of Don."

Genista parviflora. 578., add to the paragraph headed "*Spec. Char., &c.*:" "There are plants in the Horticultural Society's Garden."

G. umbellata. 578., add to the paragraph headed "*Spec. Char., &c.*:" "There are plants in the Horticultural Society's Garden; from which Mr. Gordon thinks it nearly related to *G. radiata*."

G. monosperma. 582., add to the paragraph headed "*Spec. Char., &c.*:" "Mr. Gordon informs us that this species is not more than half-hardy."

G. æthnensis. 582., add to paragraph headed "*Spec. Char., &c.*:" "In the *Companion to the Botanical Magazine*, it is stated that *G. æthnensis* inhabits the woody regions of Mount Etna, between 3,200 ft. and 6,200 ft. above the level of the sea, where it was found growing in company with *Acer villòsum* and *A. monspessulanum*. (*Comp. Bot. Mag.*, vol. i. p. 91.) There are plants of this species in the Horticultural Society's Garden, raised from seed sent there by the Honourable W. Fox Strangways, which are not more than half-hardy."

583., dele the whole of *G. scariòsa*, and add to the synonyms of *G. anxàn-tica*: "*G. scariòsa Vis. Ann. Bot.*, i. p. 2. 175.; *G. januensis Vis. Cat.*, p. 10., *Bert. Pl.*; *G. genuensis Pers. Ench.*, No. 5."

Add to the paragraph headed "*G. l. 2 latifolia* Dec.:" "There is a sub-variety with double flowers in the Horticultural Society's Garden."

G. sagittalis. 585., add to the paragraph headed "*Spec. Char., &c.*:" "*The fungi* *Dothidea genistalis Fr.*, and *Helminthosporium Genistæ Fr.*, are found on this species."

G. procumbens. 585., insert: "*Engraving. Bot. Reg.*, t. 1150." Add to paragraph headed "*Spec. Char., &c.*:" "It is a pretty little hardy shrub, well adapted for growing on rockwork."

588., before App. ii. introduce:—

"In the *Companion to the Botanical Magazine*, it is stated that M. Durien, in a botanical excursion to the mountains of Asturias, found a beautiful species of *Genista* with white flowers, which would prove a highly ornamental garden shrub. The seeds, however, were not sufficiently mature to afford hope of their germination."

G. canariensis. Page 588., after "Bot. Reg., t. 217.," add:
"and our fig. 2437." Add below:—

"*G. splendens* Webb et Bert. Hist. Natur. des Iles Canaries, t. 43., is a beautiful species not yet introduced.

"*G. stenopétala* Webb et Bert., l. c. t. 45., is also a native of the Canaries, and not yet introduced."

G. microphylla. 588., add after "Dec.:" "Webb et Bert. Hist. Nat. des Iles Can., t. 42."

Cytisus Labúrnum. 590., add to "Engravings:"
"and the plate of this tree in our Volumes of Plates."

591. l. 5., for "p. 225.," read "p. 369.;" and add to the paragraph: "Our tree has, indeed, had the variety and both the parents in flower at the same time; the laburnum flowers producing seed.

"*Other Varieties*. In addition to these varieties, it may be remarked, that some plants of both *C. Labúrnum* and *C. alpinus* have been found with fragrant flowers and that these varieties have been propagated by grafting, and may be had in the nurseries, under the names of *C. L. fràgrans*, and *C. a. odoràta*."

Statistics. 593. l. 32., add after full stop: "In Northumberland, at Alnwick Castle, are three very fine laburnums; the largest of which, in October, 1835, measured 6 ft. 11 in. in circumference, and contained 46 ft. of measurable timber. The three trees containing in all 118 ft. of timber."

C. scopàrius. 596. last line, after the full stop, add: "A decoction of the recent shoots is used by shepherds, in the north of Scotland, for dressing the backs of sheep, instead of tobacco-water. — *D. Beaton*."

C. Wèldenii. 601., add to the last line: "There are plants bearing this name in the Horticultural Society's Garden, which bear great resemblance to young plants of *C. alpinus*."

C. prolíferus. 602., to the paragraph headed "*C. prolíferus*," add: "It has stood in the open air, against a wall, at Chiswick, since 1836.

602., add to the *Half-hardy Species*:—

"*C. œblicus* Guss., Bot. Reg., t. 1902., Swt.

Brit. Fl. Gard., and our fig. 2438., has the branches round, and, as well as the leaves, hoary. Leaves trifoliate; leaflets oval, tomentose on the margin. Flowers ternate, almost bractless, racemose. Calyx membranaceous, campanulate, pubescent. Legume glabrous. A tall hoary shrub, with yellow, campanulate, pubescent flowers, and the young legumes glabrous. A native of Stromboli. Introduced in 1835, by the Honourable W. Fox Strangways, in whose garden it flowered for the first time in May, 1836. There is a fine plant against a wall in the Horticultural Society's Garden. 'In foliage,' Dr. Lindley observes, 'it bears a striking resemblance to *C. prolíferus*; but its flowers are altogether different. Its real affinity seems to be with *C. triflorus*, from which it differs in being a much larger and more woody plant, with terminal racemes of flowers; in its larger, deeper, and more distinctly campanulate calyx, and smooth, not hairy, pods. It seems as if it were an intermediate species between *C. Labúrnum* and *C. triflorus*.' (*Bot. Reg.*)

"*C. èlegans* Ait. A tall evergreen shrub, a native of the Cape of Good Hope, introduced in 1821, has stood out against a wall in front of one of the houses at Kew for several years, and is among the most beautiful species of the genus.



"*C. racemòsus* Marnock Fl. Mag., t. 18., is a handsome shrub, of moderately robust habit, about 3 ft. high. Introduced by P. B. Webb, Esq., in 1835, from the Peak of Teneriffe. It flowered, for the first time, in the nursery of Messrs. Young at Epsom."

Page 602. line 19. from the bottom, dele "*C. racemòsus*," and transpose "and" before "*C. tetragonoclàdus*."

Adenocàrpus. 604., dele the paragraph headed "*A. foliolòsus* Dec."

Amórpha (*f.*) *glàbra*. 607., add to the paragraph headed "*Spec. Char., &c.*:" "There are plants in the Horticultural Society's Garden, raised from seeds received from M. Audibert of Tarascon."

Robinia. 609., add to the paragraph headed "*Description*:" "*The fungi on the Robinia* are: *Sphæria Robiniæ* Schwein., *S. anómia* Fr., *S. profusa* Fr., *S. fissa* Pers., *Cytispora coccinea* Reb., *Myliitta Pseudacaciæ* Fr. (a truffle-like fungus, on the roots), *Sporocybe Robiniæ* Fr. The leaves of these and many other Leguminosæ are infested by *Urèdo apiculòsa* Lk. *sub Cerm.*, *U. appendiculòsa* Lk. *sub Cerm* — M. J. B."

R. dùbia. 627., to the paragraph headed "*Spec. Char., &c.*," add: "There are plants in the Horticultural Society's Garden." 2439

R. hispida. 628. l. 27., after "X, or a cross," add: "as in fig. 2439."

Caragàna (*a.*) *microphýlla*. 630., add to the paragraph headed "*Spec. Char., &c.*:" "The plant bearing this name in the Horticultural Society's Garden was received from Hamburg; and we are informed by Mr. Gordon that it is the same as *C. frutescens*." 2440

630. last line, for "*C. Altagàna*," read "*C. arborèscens*."

Colútea arborèscens. 636., add to the list of *Engravings*: "and fig. 2440., showing the flowers of the natural size."

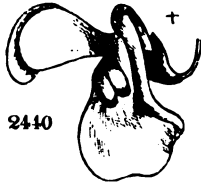

2440

Half-hardy Ldtea.

Bossia's rufa. 640. l. 6., after "*Bot. Cab.*, t. 1119.," insert: "and our fig. 2441."

Anthýllis erinàcea. 641. last line, add: "This species has stood for some years, without protection, in the open air, in the Horticultural Society's Garden." 2441



2441

Sect. III. HEDYSARUM.

Add to *Half-hardy Hedysarum*: —

Desmòdium. 645., last line, instead of "The only ligneous species which is already introduced," read: "Drummond also found 13 species in the southern and western parts of North America; but the only half-hardy ligneous species that have been introduced, as far as we are aware, are: —

"*D. polycàrpus* Dec. Prod., ii. p. 334., Don's Mill., ii. p. 295., Lam. Ill., t. 628., and our fig. 2442; *Hedýsarum polycàrpus* Poir. Dict., vi. p. 416.; has the stem round, erect, and clothed with adpressed pubescence; leaves trifoliolate, with obovate obtuse leaflets, the terminal the largest; racemes of flowers terminal and axillary, crowded; legumes with 6—8 semi-orbicular joints. Flowers purple. A native of the East Indies: notwithstanding

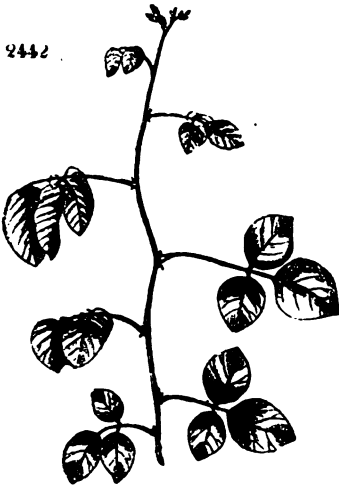

which, it stands out, without any protection, against a wall at Kew; and, in September, 1836, it was as high as the wall, and covered with flowers. Our *fig.* 2442. was taken from a sprig of this plant.

“*D. nitans* Wall. MSS., Graham in Edin. Phil. Journ., Don’s Mill., ii. 295., Hook. Bot. Mag., t. 2867., and our *fig.* 2443., is a shrub, with numerous pendulous branches; racemes of flowers compound, terminal, and axillary; leaves pendulous; leaflets roundish, rhomboid, tomentose on both sides; flowers twin; corolla bluish lilac; stamens monadelphous. A native of the East Indies. Introduced in 1823, and flowering in July and August. There is a plant in the Horticultural Society’s Garden, which has stood out for some years against a south wall, flowering freely every year, and ripening seeds, from which young plants have been raised.”

Sect. IV. PHASEOLEÆ.

Wistaria chinensis. 646. line 23. from the bottom, add, after “British gardens:”

“Mr. Knight, of the Exotic Nursery, Chelsea, has a simple method of causing this plant to flower three times in the year, by the following treatment. After the first flowering is over, which will be about the end of May, he strips off all the leaves, and cuts off all young and superfluous shoots which have been formed, to within a few eyes of the stem, which causes it to throw out fresh leaves, and to flower again in the months of July and August; and, after this flowering is over, the same process is repeated of cutting off the leaves, and this causes it to flower again in the months of October and November. It may be said that this plant will naturally flower twice, and sometimes thrice, in the season; but, when it does (which is but very seldom), the flowers are so very weak, and there are so few of them, that it is never worth notice; whereas by the above simple process an abundant succession of flowers may be insured throughout the whole season. It should be remembered that these remarks will not apply to *young* plants, but only to those that are well established. (See *Paxt. Mag. of Bot.* Feb. 1837.)”

Add to App. II. *Half hardy Phaseoleæ.* 649.

Kennedyæ rubicunda Vent. Malm. t. 104., Don’s Mill. 2., 343.; *Glycine rubicunda* Curt. Bot. Mag., t. 268.; *Carlina rubicunda* Manch; is a shrub, a native of New Holland, introduced in 1788. Flowers scarlet.

- "*K. ovata* Sims Bot. Mag., t. 2169., and our fig. 2444.; *K. cordata* Lindl. Bot. Reg., t. 944.; has the leaves broad-ovate, cordate, acute, racemes many-flowered. The flowers are bluish violet.
- "*K. monophylla*, *K. inophylla*, *K. Comptoniana*, *K. prostrata*, *K. bracteata*, and *K. sericea* are all handsome twining shrubs, natives of New Holland, which would probably stand out against a conservative wall."

Sect. V. *CASSIÆ*.

Page 660., after "*Half-hardy Species of Cassiæ*," insert:—

"*Poinciana pulcherrima* Dec. Mém. Leg., 118. 457., Bot. Mag., t. 995., has an upright branchy stem, with pinnate leaves. It has stood out in Knight's Exotic Nursery two years, without protection, flowering freely every year; but it has not yet ripened seed."

Other *Half-hardy Leguminosæ*.

- Acacia Cavènia*. 665., add to the end of the paragraph: "There are large plants in the Horticultural Society's Garden, and in the Fulham Nursery."
- A. *Julibrissin*. 666., add to the end of the paragraph: "There is a tree of this species at Desio, near Milan, 66 ft. high; diameter of the trunk 2 ft. 4 in., and of the head 24 ft.—*G. Manetti*."

ROSA *CÆÆ*.Sect. I. *AMYGDALÆÆ*.

- Amygdalus nana*. 674., add to the paragraph headed "*A. n. 3 campestris*:" "This variety is in the Horticultural Society's Garden, where it was raised from seeds received from Dr. Fischer." To the paragraph headed "*A. n. 4 incana*," add: "This kind is in the Horticultural Society's Garden, and was received from Sir Oswald Moseley." Add to the paragraph headed "*A. n. 5 sibirica*:" "It is in the Horticultural Society's Garden."
- Pérnica*. 680., add to the first paragraph: "*The fungi* on plants of this genus are: *Polyporus cervinus* Schwein., *Sphæria persicaria* Schwein., on peach stones; *S. putaminum* Schwein., on peach stones, but also on American walnuts and acorns; *Sporocybe Pérsicæ* Fr., investing the branches, twigs, and trunks of dead peach trees in vast quantities.—*M. J. B.*"
- P. vulgaris* 6 *compressa*. 680., turn the cut fig. 397.
- Armeniaca*. 681., to the first paragraph add: "*The fungi* are: *Oidium fructigenum* Kz., on the withered fruit still hanging on the branches: this also grows on plums and other fruit. *Collarium nigrospermum* Lk., *Epóchnium virescens* Fr., on fruit.—*M. J. B.*"
- 684., before Genus IV., insert:—
- "*A. pedunculata* Hort. There are plants in the Horticultural Society's Garden, raised from seeds received under this name from Dr. Ledebour."
- Prunus*. 684., before the paragraph headed "*P. spinosa*," insert:—
- "*The Fungi* found on plants of this genus are: *Peziza Rôsæ* var. *Mont.*, *Phacidium plicatum* Fr.; *Cenangium clavatum* Fr., on *P. serotina*; *C. Prunastri* Fr., on *Prunus domestica*; *Sphæria Prunastri* Pers., *S. fibrôsa* Pers., *S. micróstoma* Pers., *S. morbôsa* Schwein., covering the small branches of American plums to the thickness of an inch, with a bullate, irregular, black crust, causing

a fatal disease; *S. vibrátilis* Fr.; *S. erythróstoma* Pers., on dead leaves still hanging to the twigs; *Dothídea rúbra* Fr.; and *Puccínia Prunórum* Lk., on the leaves.—*M. J. B.*"

Prúnus doméstica 4 *myrobálana*. Page 688., insert at the end of the paragraph: "Myrobalans are fruits resembling dried plums, sold in India for giving a black dye to leather when mixed with iron filings, and also for fixing colours. (See *M'Culloch* in *Trans. Soc. Arts*, vol. xix. p. 343.)"

P. cándicans. 690., add to list of *Engravings*, "Bot. Reg., t. 1135." Add to last line: "It was first described by M. Balbis in the *Cat. of the Taurida Garden*, in 1813; and it was introduced into Britain from Bollwyller in 1825. This species is quite hardy; easily cultivated; and so laden with white blossoms in spring, as to appear a mass of snow whence the name, and not from the leaves, as Seringe supposes. (See *Bot. Reg.*, t. 1135.)"

Cérusus. 692., after the first paragraph, add: "*The fungi* on the common cherry are: *Irpex Céراسi* Fr., *Cenangium Céراسi* Fr.; *Sphæria pulchella* Pers., also on the birch; *S. varia* Pers., on the bird-cherry; *Sclerótium areolátum* Fr., *Dothídea fúlva* Fr., *Asteróma Pádi* Dec., *Urèdo porphyrogénita* Lk., all on the leaves; and *Scolicótrichum viréscens* Kz., on the branches. On the leaves of the cherry laurel are: *Ceuthóspora Láuri* Grev., *Phacídium Laurocéراسi* Desm., which also grows on *Cérusus lusitánica*.—*M. J. B.*"

C. sylvéstris. 695., add to paragraph headed "*Geography*:" "Cherries grow wild at Portella, on Mount Etna, at 2970 ft. above the level of the sea; but not lower, as the climate becomes too warm for them. (*Com. Bot. Mag.*, i. p. 91.) On the Swiss Alps, according to Kasthofer, *C. sylvéstris* ripens fruit at Chürwalden, 3964 ft. above the level of the sea, where no kernel fruit will grow. (*Voyage, &c.*, p. 145.)"

C. chícasa and *C. pubéscens*. 705., both these species Mr. Gordon considers as belonging to *Prúnus*, instead of *Cérusus*.

C. Párus 4 *bracteósa*. 709. This, Mr. Gordon informs us, is the *Párus* racemósus of Loddiges and others. He adds that there is another distinct late-flowering variety in the Horticultural Society's Garden, raised from seeds received from Douglas; and which appears to be the same as *C. mollis*. (See p. 714.)

C. lusitánica. 714., add to our list of *Engravings*: After "*C. l. 2 Híxa Ser.*" add: "*C. Híxa* Webb et Bert. Hist. Can., t. 38., and our *fig. 2445*, taken from that magnificent work."

715. l. 15., insert "not" after "is."

716. l. 6., after the full stop, insert: "In Cheshire, at Combermere Abbey, it is 28 ft. high, and the branches cover a space 196 ft. in circumference."

l. 8., after the full stop, insert: "In Suffolk, at Stutton Rectory, it is 25 ft. high, and the branches cover a space 225 ft. 2 in. in circumference."



Sect. II. *SPÍRÆÆ*.

Kérria. 722. l. 28., after the full stop, insert: "A plant of this state of the species (see *fig. 2446*.) was sent to the Horticultural Society's

Garden in the beginning of 1835, when it was in full flower. It was planted in the open ground, where it has since stood without any protection, and has grown vigorously and flowered."

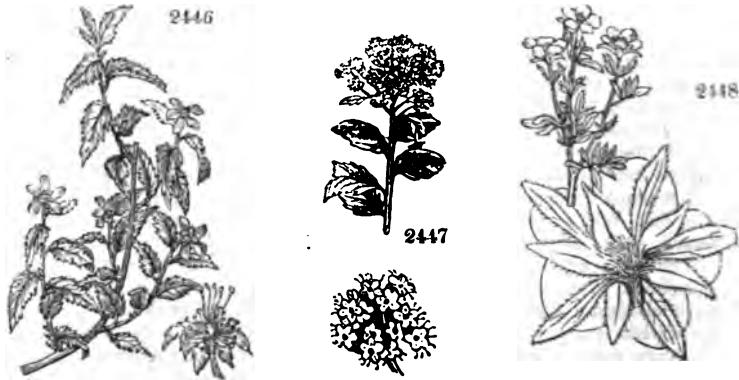

- Spiræa chamædrifolia* media. Page 724., add: "and our fig. 2446."
S. ulmifolia phyllantha. 725., add: "and our fig. 2448."
S. cratægifolia. 725., add: "Engraving. Our fig. 2450."
S. betulæfolia. 725., add to the list of Engravings: "and our fig. 2447."



725. l. 5. from the bottom, for "We have not seen the plant," read "There is a plant of this species in the garden of the Horticultural Society, received from M. Fischer of Göttingen. It is a very distinct little species, approaching *S. vacciniifolia* D. Don."

S. alpina. 726. The species mentioned by J. D. is, Mr Gordon informs us, *S. thalictroides* (p. 728.), and is known under the names *S. hypericifolia* var. *flava*, and *S. alpina latifolia*.

S. hypericifolia Besseriana. 727., add: "and our fig. 2451."

S. ceanothifolia. 728., add: "Engraving. Our fig. 2452."

S. sakicifolia alpestris. 729., add: "Our fig. 2453."

732., insert before the last paragraph: "There are plants under the name of *S. nutans*, from the Himalayan Mountains, in the Horticultural Society's Garden, which were raised from Mr. Royle's seeds; and these Mr. Gordon



thinks the same as *S. argentea*. There is also a plant named *S. tatarica*, a very distinct upright species, which flowers sooner than any other of the genus; and there are two species from the Himalayas, which are without names."

Sect. III. POTENTILLÆ.

Rubus. Page 735., after line 12. introduce:—

"The Fungi on the different kinds of bramble are: *Peziza plágopus* *β Wormsk.*, on *Rubus triflorus*; *P. clandestina Bull.* *P. rúfo-olivácea A. et F.*; *Sphæria rostella Fr.*, also on roses; *S. clypeata Nees*, *S. callimórpha Mont.*, *S. Chamæmóri Fr.*; *Dothidea impressa Fr.*, on living leaves of *R. Chamæmorus*; *D. Chætómium Fr.*, on leaves; *Phacídium Rúbi Fr.*, also on leaves; *P. rugosum Fr.*, *Hystérium Rúbi Pers.*, *Excípula Rúbi Fr.*, *Leptostroma Spirææ Fr.*, *Didérma depressum Fr.*, *Phýsarum flavum Fr.* On the leaves grow *Arégma bulbosum Fr.*, *A. acuminatum Fr.*, *Urèdo Ruborum Dec.*, *U. interstitialis Schlecht.*, *U. gyròsa Reb.*, *Sclerótium Rúbi Carm.*; and on the leaves of *Rubus strigosus* *Æcidium nitens Schwein.*—*M. J. B.*"

R. idæus. 737., to the list of Engravings, add: "and our fig. 2454."

R. fruticosus L. 742., at the end of the paragraph headed "*R. f. 4 flore roseo pleno*," for "but we have not seen it," &c., substitute, "and there are plants in the Horticultural Society's Garden."

Potentilla fruticosa. Varieties. 748., to the paragraph headed, in the preceding page, "*P. f. 2 dahurica*," add: "There are plants in the Horticultural Society's Garden and in the Epsom Nursery. It is a much smaller plant than the species, and has smaller leaves."

To the paragraph beginning "*P. f. 3 tenuiloba*," add: "There are plants in the Horticultural Society's Garden, under the name of *P. floribunda*."

748. insert:—



"GENUS X. a.



COWANIA D. DON. THE COWANIA. *Lin. Syst. Icosándria Polygýnia.*

Identification. D. Don in *Swt. Brit. Fl.-Gard.*, 2d. ser., t. 400.

Gen. Char., &c. *Calyx* 5-cleft. *Petals* 5. *Ovaries* 5—14. *Ovule* erect. *Styles* terminal, continuous. *Achenia* awned with the plumose persistent styles. *Embryo* erect.—Evergreen, leafy, much-branched shrubs; natives of Mexico. Leaves lobed, coriaceous. Stipules adherent. Flowers terminal, solitary, almost sessile; red, and very handsome. (*D. Don.*)

"1. COWANIA Plicata D. Don. The plaited-leaved Cowania.

Identification. Don in *Sweet's British Flower-Garden*, t. 400.; *Gard. Mag.*, 13. p. 452. *Engravings.* *Swt. Brit. Fl.-Gard.*, t. 400.; and our *Fig. 2455.*

Spec. Char., &c. Leaves wedged-shaped, oblong, pinnatifid, plaited. *Ovaries*, 14. (*D. Don.*) A rigid, evergreen, decumbent, much-branched shrub about 2 ft. high, and furnished with a dark brown bark. Branches copiously clothed with stalked glands; scaly below, from the remains of past leaves. Leaves cuneately oblong, pinnatifid, plicate, $\frac{1}{2}$ in. or more in length; dark green, minutely glandular, and shining above; white and downy beneath with adpressed cottony pubescence: the nerves prominent: lobes varying

from 5 to 7, short, obtuse; the margins revolute and occasionally toothed. Petioles very short, slightly channeled above, sheathing at the base. Stipules adherent; the free apices subulate, hairy, green, shorter than the adherent portion. Flowers terminal, solitary; when in the bud state, exactly like those of *Rosa*. Peduncles extremely short, cylindrical, thickened towards the apex, copiously downy and glandular, and furnished at the base with a single, linear, acuminate, channeled, glandular bractea.

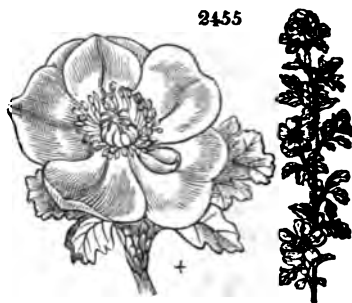

Calyx turbinate, hollow, copiously downy and glandular; tube glabrous, shining and green within; limb 5-parted, spreading; segments ovate, acuminate, entire. Petals 5, obovate, double the length of the calycine segments, of a rich lilac. Stamens 72, disposed in many series. Filaments capillary, glabrous, white, pink at the base. Anthers cordate, yellow, bilocular; the cells parallel and opening lengthwise. Ovaria 14, free, arising from the centre of the torus, which is seated at the bottom of the calyx; oblong, clavate, copiously silky. Styles continuous, short. Stigmas terminal, simple, yellow, minutely papillose. Achenia about 8, turbinate, silky, crowned by the persistent feathery styles, which are 1½ in. long. 'We have seldom,' Professor Don remarks, 'had an opportunity of laying before our readers a subject of equal interest and beauty with the present, which is not only a new species, but a new genus, to our gardens. It was raised by our zealous friend Mr. Thomas Blair, gardener to Mr. Clay at Stamford Hill, from seeds picked from a specimen collected by Captain Colquhoun in the uplands of Mexico. It promises to be sufficiently hardy to endure our winters in the open air; and, as it is an evergreen shrub, with a peculiar habit, and large showy blossoms resembling a small rose, it must be regarded as the most valuable addition made to our gardens for some years past.' The genus was originally founded by Professor Don, in the *Linnean Transactions*, vol. xiv., on another species, collected in the same country by Sesse and Mocino, and which is distinguished from the present one by its tripartite leaves, with entire lobes. Professor Don considers the genus to be exactly intermediate between *Dryas* and *Púrhia*, differing from the former in the quinary arrangement of the floral envelopes and definite ovaria; and from the latter, in the more numerous achenia, crowned by the persistent feathery styles."

Sect. IV. *Ròsæ*.

- Ròsæ*. Page 750., add to the first paragraph: "*The Fungi* are: *Sphæria Dothidea Moug.*, also on the ash; *S. sæpícola Fr.*, *Erysiphe pannosa Walbr.*, *Corynæum marginatum Nees*, *Cladosporium fuscum Lk.*; *Næmáspora Ròsæ Desm.*, on the fruit; *Fusarium fructigenum Fr.*, *Sporótrichum elæóchroum Fr.*, on the leaves; *Perispórium speireum Fr.*, *Asteróma radiósum Fr.*, *Septaria Ròsæ Desm.*; *Arégma speciósum Fr.*, on *R. corymbifera*; *A. mucronatum Fr.*, syn. *Puccinia Ròsæ Grev.*, t. 15., *Urèdo Ròsæ Dec.*, *U. píniguis Dec.*—*M. J. B.*"
- R. microphýlla*. 751., add to the end of the paragraph headed "*Spec. Char., &c.*:" "There is a variety in the Horticultural Society's Garden called *R. m. álba.*"
- R. alpína*. 756., add to "*Varieties:*"—
 "■ *R. a. 15 speciósa* Hort., Drummond's Thornless, was raised by Mr. Drummond, in the Cork Botanic Garden."

- R. Sabini*. Page 758., add to "*Spec. Char., &c.*:" "There is a variety in the Horticultural Society's Garden, under the name of *R. s. grácilis*."
- R. Doniána*. 759., add to the paragraph headed "*Spec. Char. &c.*:" "There is a variety in the Horticultural Society's Garden, called *R. D. hórrida*."
- R. Wilsoni Borr.* in *Brit. Fl.*, ed. 3., p. 231., *Eng. Bot. Suppl.*, t. 2723. On this rose, Dr. Lindley remarks, that it seems one of the endless varieties of *R. móllis*; approaching *R. Doniána*, in the presence of setæ on its branches; and proving, among other things, that *R. involúta*, *R. Doniána*, *R. Sabiniána*, &c., are all one and the same natural species. (See *Comp. Bot. Mag.*, i. p. 189.)
- R. damascéna*. Add to "*Engravings:*" "and our *fig. 2456.*, of *R. d. subálba*."



- R. centifóka*. 760., after the paragraph headed "*R. c. 2 muscòsa*," insert:—
 "■ *R. c. m. cristàta* Hook. *Bot. Mag.*, t. 3475.—A very beautiful and curious variety of the moss rose, introduced from France in 1833, and remarkable for the manner in which the moss springs from the edges of the sepals."
- Add, after "*R. c. 3 pomponia Dec.*:" "*N. Du Ham.*, viii. p. 37.; *R. pomponia* Red. *Ros.*, p. 65." Add to the end of the paragraph: "These roses should be cut down every year, when they have done flowering, that they may send up new shoots to produce flowers every spring. If this be not done, the principal branches will dry up, and become bare, like those of the bramble."
- R. gállica*. 760., add to list of *Engravings:* "and *fig. 2457.*, of the species."
- R. álba*. 764., add to list of *Engravings:* "and *fig. 2458.*, of the double variety, common in gardens."
- R. lítea*. 765., after "*Varieties,*" add:—
 "■ *R. l. 4 flore pléno*. Williams's *double yellow Sweet Briar*.—This very beautiful variety was raised from seeds of this species by Mr. Williams of Pitmaston. It is a free flowerer, and forms a very ornamental low shrub. There are plants in the Horticultural Society's Garden."



" * R. l. 5 *Hoggii* D. Don in *Swt. Brit. Fl.-Gard.*, t. 410. — An upright-branching shrub, with brownish purple branches, armed with numerous, straight, spreading unequal prickles. Leaves pale green; petiole and rachis slender, filiform, sparingly hairy and glandular; leaflets elliptical, mucronulate, doubly and sharply serrated, membranous, glabrous and concave above, sparingly glandular beneath, $\frac{1}{2}$ in. long. This variety was brought from New York, by Mr. James M'Nab, who received it from Mr. Thomas Hogg, nurseryman in that city, by whom the plant was raised from seeds of the single yellow rose; and it is known in the nurseries by the name of 'Hogg's Yellow American Rose.' It is a pretty variety; but it is surpassed in the fulness of its flowers, and in richness of colouring, by Williams's double yellow rose. It is of easy culture, flowers freely, and may be increased by layers, or by being budded on stocks of the sweet briar and dog rose. (*Swt. Brit. Fl.-Gard.*, Dec.)"

R. *rubiginosa*. Page 766., add to "Varieties:"—

" * R. r. 13 *Lyonii* Hort. — There are plants in the Horticultural Society's Garden."

R. *canina*. 767., add to "Engravings:" "and our fig. 2459."

R. *indica*. 771., add to "Varieties:"—

" * R. i. 12 *flavescens* Hort. — This, Mr. Gordon assures us, is the true tea-scented yellow China rose, and not the preceding variety, which is generally confounded with it."

" * R. i. 13 *Blairi* D. Don in *Swt. Brit. Fl.-Gard.*, t. 405. — A tall-growing shrub, raised about seven years ago, by Mr. Blair, from the seeds of the yellow China, which had been fecundated by the pollen of the Tuscan rose. Its aspect is more robust than that of the other varieties of the China rose; and it is remarkable for the size of its leaves and flowers. The petals are yellow at the base, especially towards the centre of the flower; and are, besides, frequently furnished with a white stripe along the middle; a character also present in the common blush China rose. The blossoms are produced in abundance: they are very fragrant, and their colour is of a rich purple. It is a strong-growing kind, and there are few varieties more worthy of cultivation. It may be increased by cuttings, or budded on any of the common roses.

There are plants at Mr. Clay's, Stamford Hill. (*Swt. Brit. Fl.-Gard.*, Nov.)"

R. *sinica*. 776., add to "Synonymes:" "R. hystrix Lindl. Monog.; R. lævigata Michx. Fl. Bor. Amer., on the authority of Dr. Lindley, in *Bot. Reg.*" Add to "Engravings:" "Bot. Reg., t. 1922., and our fig. 2460."

R. *macrophylla*. 778., add to the end of the paragraph: "There are plants of this species in the Horticultural Society's Garden. There are also plants of R.

tetrapétala raised from seed sent home by Mr. Royle; and several other species received from the Snowy Mountains of the Himalayas."

783., add to the paragraph, last line but one: "Mr. Rivers, in November, 1837, published a general description of the roses in common cultivation, under the name of the *Rose Amateur's Guide.*"

Rosarium. 794. to 797. At the end of the article add as follows:—

" Fig. 2461. is a design for a rosarium, by Mr. Rutger. It is formed on a



2459



2460

2461

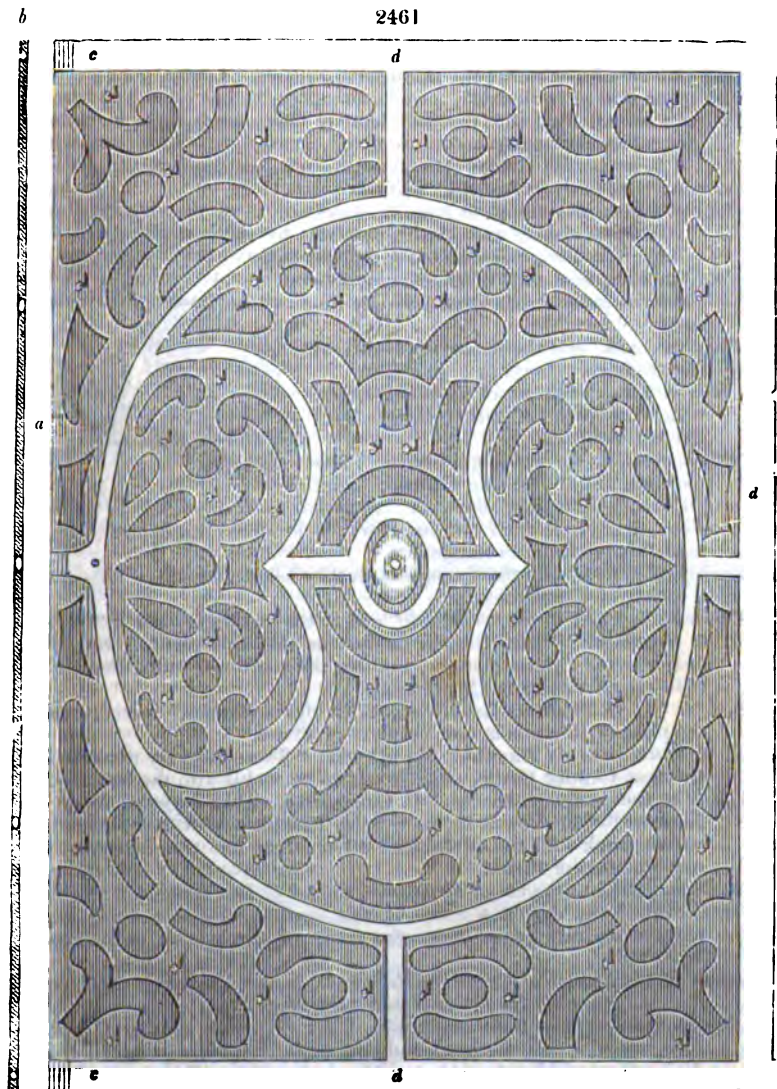

flat surface of lawn, at one side of which is a terrace walk (*a*) in front of a wall for climbing roses (*b*), from which there is a descent by steps (*c c c*). The beds are of various forms, but the spaces between them and the walks, and also between one and another, are never narrower than 6 ft.; in consequence of which the spectator may walk round the whole, either on grass or on gravel, according to his taste. The terrace walk (*a*) and the side walks (*d d d*) are 12 ft. wide. The rose wall is supposed to be 10 ft. high, fronting the south-east, and the roses are planted behind it; in part brought over the wall and trained downwards, the other side being also covered, and in part brought through holes in the wall near the bottom, and trained upwards. The wall is ornamented with piers surmounted by vases. Among the beds on

the lawn are interspersed standard roses, as indicated in the figure. In the centre there is a basin and fountain. The walks (*ddd*) are supposed to be covered with arcades of roses; the side next the rosarium to have open arches, and the other side to be closed."

Crataegus coccinea. Page 817. line 20., dele "c." before "*coccinea*."

To the "*Varieties*" add:—

"♀ *C. c. 5 neapolitana* Hort.; *Méspilus constantinopolitana* *Godfrey*."

C. punctata. 818. to the "*Varieties*" add:—

"♀ *C. p. 4 brevispina* Doug., and our *fig. 2462*.

A very handsome fastigiate tree, with large, very dark, purplish-red fruit."

C. ovalifolia. 821., in the list of *Engravings*, dele "and the plate of this species in our Second Volume."

C. Douglasi. 823., dele the *Synonyme*, which, as stated above, belongs to *C. punctata*.

C. trilobata. 824., in the list of *Engravings*, dele "and the plate of this species in our Second Volume."

C. Arónia. 827., in the paragraph headed "*Engravings*," for "*Pococke Cratægi*," read "*Pococke's Travels*;" and dele "according to Willdenow." In "*Spec. Char., &c.*," l. 4. from the end, for "It produces its foliage early," read "It produces its foliage late."

C. heterophylla. 829., dele the *Synonymes*, as they belong, as stated above, to a variety of *C. coccinea*.

C. Oxyacantha. 831., in the "*Varieties*," add to the paragraph headed "*C. O. 9 purpurea*:" "Mr. Gordon informs us that this plant is now no longer in the Epsom Nursery, and that the plant now called there the red-twigged variety is *C. prunifolia*."

832., after "*C. O. 21 stricta* Lodd. Cat., *C. O. rigida* *Ronalds*," insert: "and the plate of this tree in our Volumes of Plates."

840., to "*Recorded old Hawthorn Trees*," add: "There is a very remarkable thorn at Cawdor Castle, which is said to be coeval with the building."

841., add to the paragraph headed "*C. Oxyacantha, and its Varieties, North of London*:" "In Yorkshire, in Studley Park, it is 43 ft. high, diameter of the trunk 4 ft., and of the head 48 ft. This fine tree is figured in our Volumes of Plates."

C. mexicana. 843., to the list of *Synonymes*, add: "*C. Lambertiana* Hort."

§ xvi. *Glauca*. 844., dele the whole of this section, *C. glauca* being now made a separate genus under the name of *Stranvæsia*, as indicated in p. 2563.

Synopsis of the Species of Crataegus, &c. 845., in the *Synonymes* to *C. cordata*, to "*populifolia* *Fischer*," add "*Göttingen*."

C. Oxyacantha pterifolia. 846., insert, after l. 2.: "There is another *C. pterifolia*, which is very distinct; and also *C. O. oxyphylla*, received from Major-General Monckton, in the Horticultural Society's Garden."

C. oxyacanthoides. 846., to the paragraph beginning, "Only differing, &c.," add: "and in the fruit containing more than one seed."

846., after "31. *C. tanacetifolia* glabra," add, "31.* *C. t. Leeana*;" and after 38. *C. coccinea* máxima, add, "38.* *C. c. acerifolia*;" both as paragraphs.

After "40. *C. georgica* Doug.," add, "syn. *C. indentata* *Lodd*."

847., after "47. *C. punctata stricta*," &c., add "47.* *C. p. brevispina*."

Among the *Synonymes* to 55. *C. viridis*, dele "*florida* *Lodd*." &c., and "*grossulariæfolia* *Lee*," &c.

Before "56. *C. virginiana*," &c., add:—

"55.* *C. spatulata* *Lindl*,"

syn. *florida* *Lodd*., *fig. 613*. in p. 867.



"55.** *C. grossulariæfölia* *Lee*, *figs.* 559. and 616.

syn. *lineàris* *Lodd.*

parvifölia *Lee.*"

Add to the end of the section: —

"*C. tríloba* *Lodd.*"

For "*C. gláuca*," &c., read "*Stranvæ'sia glaucéscens* *Lindl.*"

Add to "*Additional Species of Cratægus.*" Page 848.

"*Cratægus florentina* *Zucch.*; *Méspilus florentina* *Bert.* Leaves long-ovate, heart-shaped at the base, dentate, woolly underneath. Calyx woolly, lobes deciduous. Fruit ovate-globose, glabrous, 5-seeded. A native of Tuscany; flowering in spring, and ripening its fruit in autumn. This species, of which a notice has been sent us by Sr. G. Manetti, does not appear to have been introduced.

"*C. opàca* *Hook. et Arn.*, *Comp. to Bot. Mag.*, 1. p. 25. This species was found by Drummond, near New Orleans, in 1833. It is described as having oblong, obtuse, opaque leaves, attenuated at the base, and subsinuated; obscurely serrated, glabrous above, and ferruginous pubescent near the nerves beneath. The specimen found by Drummond was in fruit, and he did not see the flower. The fruit was about the size of that of *C. Oxycántha*, marked in the dry state with five furrows, alternating with the cells, and crowned with the triangular segments of the calyx, Dr. Hooker thinks it quite distinct from any other species that he is acquainted with."

849., before App. iv., insert: —

"These species of *Cratægus* were all taken up, and replanted, in the autumn of 1836, and some changes made, in consequence of which our *Synonymes* will no longer apply; but those who purchased plants from Messrs. Loddiges previously to that year may rely on its correctness."

868., insert: —

"GENUS XIII.*



STRANVÆ'SIA Lindl. THE STRANVÆSIA. *Linn.*, *Syst.* Icosándria Di-Pentagýnia.

Identification. Lindl. in *Bot. Reg.*

Synonyme. *Cratægus*, in part.

Derivation. "Named after the Honourable *William Thomas Horner Fox Strangways*, F.H.S., a learned and indefatigable investigator of the flora of Europe."

Gen. Char. Calyx 5-toothed. Petals 5, concave, sessile, spreading, villous at the base. Stamens 20, spreading. Ovary villous, superior, 5-celled; cells containing 2 ovules. Fruit spherical, enclosed by the calyx, containing the superior, 5-valved, hard, brittle, dehiscent capsule. Seeds oblong, compressed; testa cartilaginous; radicle exserted.—Evergreen trees, natives of the temperate parts of Asia. Leaves simple. Flowers corymbose. (*Lindl.*)

"† 1. S. GLAUCE'SCENS *Lindl.* The glaucous-leaved *Stranvæ'sia*.

Identification. Lindl. in *Bot. Reg.*, t. 1956.

Synonyme. *Cratægus gláuca* *Wall. Cat.*, 673.

Engravings. *Bot. Reg.*, t. 1956.; and our *figs.* 562. and 563., in p. 845.

Spec. Char., &c. Leaves lanceolate, coriaceous, serrated, pointed at the base; midrib and nerves on the under side, as well as the young twigs, hairy; corymbs somewhat woolly; pedicels three or four times as long as the bud. (*Lindl.*)" For description, &c., see that of *Cratægus gláuca*, p. 844.

Cotoneúster (v.) *laxiflóra*. 871., after the paragraph headed "*Spec. Char.*, &c.," insert: —

- "*C. (v.) l. 2 uniflora* Fischer. — There are plants in the Horticultural Society's Garden."
- C. nummulària*. Page 872., after the paragraph headed "Derivation," insert: "Synonyms. *C. elliptica Hort.*; *Eriobótrya elliptica Lindl., Lin. Trans.*; *Méspilus Cwile Hort.*"
872. To the paragraph headed "*Spec. Char., &c.*," add: "It bears numerous berries, which are black when ripe."
- C. lævis* Lodd. There is a plant bearing this name in Messrs. Loddiges's arboretum, which appears to approach *C. nummulària*; but, as we have never seen either flowers or fruit, we cannot speak decidedly.
- Pyrus comminis. Statistics.* 888., add before "in Scotland," &c.: "In Yorkshire, at Doncaster, there is an old pear tree in the garden belonging to one of the houses in the High Street, which, tradition says, was planted by Charles I., who in one of his progresses dined at this town. Though much decayed, it bears annually an abundant crop of small brown fruit."
- P. variòlòsa.* 891., add to "*Spec. Char., &c.*:" "The young seedling plants of this species, Mr. Gordon informs us, have their leaves cut like those of *Cratægus Oxyacántha.*"
- P. Michauxii.* "There are plants of this species in the Horticultural Society's Garden."
- P. (Málus) prunifòlia.* 892., in the list of *Engravings*, dele the words "and the plate in our Second Volume."
- Pyrus (Málus) diòtea.* 893., add to "*Spec. Char., &c.*:" "Mr. Gordon informs us that there are plants in the Horticultural Society's Garden."
- The Little grey Ermine Moth.* 906., after the second paragraph in p. 907., insert: —
- "It is a peculiarity in the history of this insect, that it is not only social in the caterpillar state (*fig. 2463. a*), but that it retains its sociality during

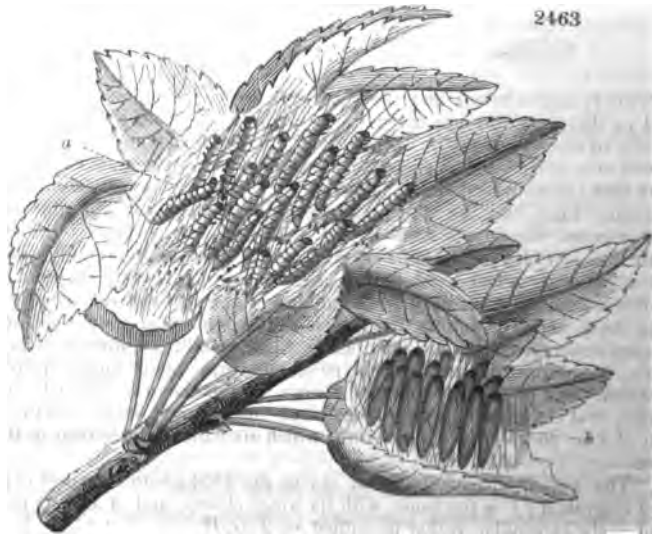

the period of its pupation (*b*), the cocoons being formed within the web which had served for the abode of the caterpillars. These webs are quit-
 ted from time to time, and new encampments established at short distances
 from each other; hence, each brood constructs several webs in the course of
 its caterpillar state; the reason of which is, that the caterpillars do not quit
 their webs to feed, but only eat such leaves as are enclosed in each web.

The number of inhabitants in a colony varies from 100 to 200; and, hence, the more numerous the colony, the more frequently is a change of residence required. These webs consist of a great number of threads, not unlike spider webs, arranged somewhat irregularly, but sufficiently loose to enable the inhabitants to be seen through the covering. The caterpillars eat only the parenchyma of the upper side of the leaf; they also arrange their threads longitudinally, each, apparently, having a thread of its own, along which it moves either backwards or forwards without disturbing its neighbours, which, when in repose, are arranged side by side. The larger-sized nests include several of the smaller branches or twigs with their leaves; and some parts are of a firmer texture than the rest, apparently for resisting the wet. When the parenchyma of the upper sides of the leaves enclosed in the web has been consumed, the nest is abandoned, and a new one made, enclosing a fresh bunch of twigs, each of the caterpillars spinning a considerable number of threads; and thus each colony constructs as many as 6 or 8 distinct webs, disfiguring the tree, especially when, as is often the case, there are many societies established upon it. The leaves, thus half-consumed, wither up, as well as the young branches, for want of support, and the tree assumes the appearance of having been entirely scorched up with fire. The caterpillars rarely quit their nests; but, when alarmed or disturbed, they endeavour to make their escape by spinning a long thread, and dropping to the ground. When touched, also, they writhe about with great activity, and will run backwards nearly as fast as forwards.

"When full grown, about the beginning of July, each caterpillar encloses itself in a long and nearly cylindrical cocoon of white silk (*fig. 2464. d*), of



a leathery consistence; and these cocoons are arranged side by side at one end of the nest, forming a mass not unlike, only considerably larger than, a mass of ants' eggs, as the cocoons of the ant are commonly called. As the whole of a colony has been reared from one brood of eggs, it is generally the case that the entire number commence the construction of their cocoons at the same time, and the whole are generally completed in the same day. In this cocoon, the insect immediately undergoes its change to the chrysalis state (*fig. 2464. c*); and its chrysalis, which does not materially differ from those of other small lepidopterous insects, is of a shining chestnut colour. It differs, however, from the chrysalides of the leaf-rollers, in wanting the transverse series of hooks with which the abdominal segments of the latter chrysalides are furnished; and hence, when, at the expiration of about 20 days, the perfect insect is ready to come forth, being unable to work the chrysalis out of the cocoon, the escape of the imago is effected within the latter, and the moth, with its wings in an unexpanded state, makes its way out of one end of the cocoon, after which its wings soon spread to their full size.

"The perfect insect is shown at *e* in *fig. 2464.*, with its wings expanded, and magnified; *f* is the same, with its wings closed, and of the natural size; and *g*, the caterpillar, rather magnified. — *J. O. W.*"

P. (c.) angustifolia. 909., dele the (*c.*).

Additional Species of Pyrus belonging to the § Mâlus. 910.

"*P. ? Schôtii Ledeb.* There is a plant in the Horticultural Society's Garden, received, under this name, from Dr. Ledebour.

"*P. stipulacea Hort.* There are plants in the Horticultural Society's

Garden, the seeds of which were received, under this name, from the Himalayas."

P. A'ria. Page 910., in the "*Varieties*," after "*P. A. 4 angustifolia* Lindl., l. c.," insert: "*P. A. longifolia* Hort."

P. A. 6 crética. 910., after "*P. græ'ca* Hort.," insert: "*P. A. edulis* Hort., *Cratægus græ'ca* Hort."

P. rivularis. 915. l. 29., for "*Hooper's*," read "*Hooker's*;" and add to the end of the paragraph: "Plants of this species are in the Horticultural Society's Garden, and were raised from seeds sent home by Douglas."

P. americana. 920., add to the list of *Synonymes*: "*P. canadensis* Hort."

P. Sorbus. *Statistics*. 924. l. 15., dele "In Shropshire, at Kinlet, it is 45 ft. high."

924. l. 19., for "and is about 25 ft. high," read "(see fig. 644. in p. 922.)"

P. spirea. l. 8. from the bottom, dele the "?" before "*P. sambucifolia*," in the list of *Synonymes*.

P. (arbutifolia) melanocarpa. 926., add to the list of *Synonymes*: "*Mésopilus capitata* Lodd.; *M. floribunda* Lodd.; *M. pubens* Lodd. *Cat.*, 1836."

P. (a) m. 2 subpubescens Lindl. 927., after the other references, insert: "*P. m. xanthocarpa* Hort."

P. grandifolia. 928., add to list of *Engravings*, "and fig. 2465."

P. Chamæméspilus. 928., to "*Spec. Char., &c.*," after "*(Dec. Prod., ii. p. 637.)*," add: "The fruit is orange-coloured."

Eriobótrya. 934., dele the whole of the paragraph headed "*E. elliptica*," the plant proving the same as *Cotoneáster nummulària*. (See p. 2564.)

Kagenéckia cratægoides. 934. l. 25., add, after the full stop: "The male flowers are in bunches, and terminal, as shown in fig. 657.; but the female flowers are solitary. Fig. 2466. shows a specimen of the fruit, which ripened in the Horticultural Society's Garden in the autumn of 1837."

To the end of the paragraph, add: "There is another species of *Kagenéckia* in the Horticultural Society's Garden, with leaves nearly twice the size of those of *K. cratægoides*."

Calycánthus lævigátus. 937., l. 8. from the bottom, for "*férox*," read "*férax*."

Chimonánthus frágrans. 938., add to "*Varieties*:" "*■ C. f. 4 parviflorus* Hort. — This, Mr. Gordon informs us, is a very distinct and late-flowering variety. There are plants in the Horticultural Society's Garden."

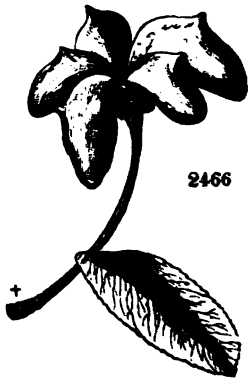

GRANATA'CEÆ.

Punica Granátum. *Soil, Situation, and Culture*. 942. l. 9., after full stop, insert: "The double pomegranate, grafted on the single, is a less vigorous tree, and more productive of flowers. If in good rich soil, properly managed and supplied with water, it will continue flowering for four or five months."

ONAGRA'CEÆ.

Fuchsia microphýlla. 944., add to the end of the paragraph: "The berries are very sweet."

F. excorticata. Page 945., add to the end of the paragraph: "The berries are so sweet, that the missionaries have been trying to introduce the species into Otaheite, as a sugar plant; but have been unable to procure seeds, as in New Zealand the berries are eaten greedily by the pigs, as soon as they appear."

"*F. fulgens* Dec., Lindl. in Bot. Reg., n. s. t. 1. This is a splendid plant, a native of temperate regions of Mexico, which will probably prove half-hardy."

PHILADELPHA'CEÆ.

Philadelphus. 954., before § ii. insert:—

"*P. Gordoniana* Hort. is a kind received from the banks of the Columbia; which grows in its native country like underwood, and flowers later than most of the species."

After § ii., &c., insert:—

" 6.* *P. SPECIOSUS* Schrad. The showy-flowered Philadelphus, or Mock Orange.

Identification. Schrad. Diss. Phil.; Lin. Bot. Reg., t. 2003.

Engraving. Bot. Reg., t. 2003.

Spec. Char., &c. Leaves ovate, rarely oval-ovate, long-pointed, sharply toothed and serrated; hairy beneath. Flowers ternate and solitary. Lobes of the calyx very sharply pointed. Style deeply 4-cleft. Stigmas longer than the stamens. (*Schrad.*) *P. speciosus* is a hardy shrub, 8 ft. or 10 ft. high, with gently bending branches, loaded with very large and scentless white flowers. This species, Dr. Lindley observes, though one of the handsomest of the genus, is one of the least common. There are plants in the Horticultural Society's Garden."

P. grandiflorus. 954., dele the line headed "*Synonyme*," the words "and our fig. 676.," and the last sentence in the paragraph headed "*Spec. Char.*"

Deutzia scabra. 956., Mr. Gordon informs us, proves to be quite hardy.

956., add, after the paragraph headed "*D. Brunonia*:"

"*D. grandiflora* Hort. There is a plant bearing this name in the Horticultural Society's Garden, which was received from China."

MYRTA'CEÆ.

Eucalyptus robusta. 959. l. 2., add after parenthesis:

"fig. 2767. shows a full-grown tree of this species, growing near Port Jackson."

959., in the paragraph headed "*E. amygdalina*," for "94.," read "694."

Before the last paragraph, insert:—

"*E. alpina* Hort. There is a plant bearing this name in the Norwich Nursery, which appears hardier than any other species of the genus: it is also of much slower growth, and is of a bushy compact habit, sending out laterals at every joint. It is a native of Mount Wellington, in Van Diemen's Land, where the climate is very similar to that of England; and the seeds of it were sent to England by Mr. James Backhouse, about 1834."

961., add to the paragraph headed "*Leptospermum lanigerum*:" "This species is called, in Van Diemen's Land, the hoary tea tree; from the circumstance of the leaves having been used as a substitute for tea. Several other kinds of *Leptospermum* are designated tea trees, from the same cause; such as *L. baccata*, the smooth, or berry-bearing, tea tree; *L. flexuosum*, the forest tea tree; *L. grandiflorum* *Lodd. Bot. Cab.*, t. 514., &c. They are all beautiful myrtle-like evergreen plants, which would probably prove



hardy, or very nearly so, in this country; and have all showy white flowers, with the exception of *L. stellatum*, the flowers of which are yellow."

"*L. scoparium* Forst., *Jacksonia scoparia* Cunn., and our fig. 2468, the *Broom Tree*, or *Dogwood Tree*, of Van Diemen's Land, is also a native of New Zealand, where it was employed for tea by Captain Cook and his crew; whence its common name of the New Zealand tea plant. (See *Comp. to Bot. Mag.*, ii. p. 70. 228.)"



Myrtus communis L., page 963., the common *Myrtle*, and our figs. 2469, 2470. To the first paragraph, add: "The garden of Sir Walter Raleigh, now the property of Colonel Fount, runs along the ancient city wall of Youghal, which is covered to the top by flowering myrtles of the most luxuriant growth."

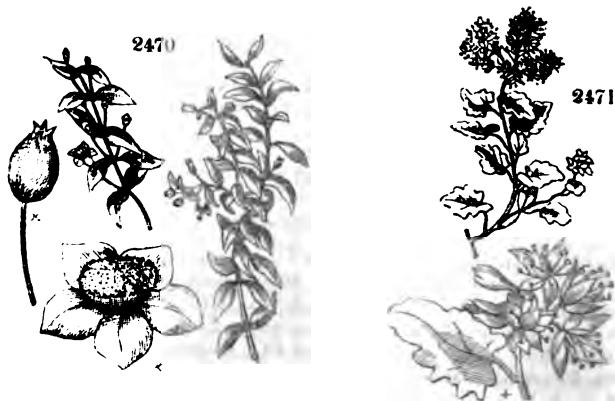

CRASSULACEÆ.

Sedum populifolium. 965., add, after the references: "and our fig. 2471."

Page 967., add before Chap. LIV.

"CHAP. LIII.*

OF THE HALF-HARDY LIGNEOUS PLANTS OF THE ORDER
REAUMURIA'CEÆ.

2472

Reaumuria hypericoides Willd. Spec., 2. p. 1250., Bot. Reg., t. 845., and our figs. 2472 and 2473; *Hypericum alternifolium* Labill; has fleshy leaves, somewhat lanceolate, flat, rather remote. A shrub from 1 ft. to 2 ft. high, a native of Syria, in arid places; introduced in 1800, and producing its rose-coloured flowers from June to October.



2473

R. vermiculata Linn. Spec. 754., has the leaves subulate, semiterete, imbricated, and crowded on the branches. It is an elegant little shrub, a native of Sicily, Barbary, and Egypt, on the sea shore. Flowers white or pale red. Introduced in 1828. The leaves of both species are dotted, and exude globules of a saline alkali."

CACTA'CEÆ.

Opuntia vulgaris. 967., after the references add: "and our fig. 2474." Add to the end of the paragraph: "The fungi found on it are: *Sphæria Tinae* Spreng., and *S. Cacti* Schwein.—*M. J. B.*"



2474



2475



2476

GROSSULA'CEÆ.

Ribes. 968., end of paragraph headed "Description," introduce:—

"Fungi. These are: *Polyporus Ribis* Schum., *Cenangium Ribis* Fr.; *C. repandum* Fr., on *R. petraeum*; *Sphæria strumella* Fr., *S. vestita* Fr., *S. Ribis* Tode, *S. uberiformis* Fr., *S. Grossulariæ* Fr., and *S. ribicola* Fr., on leaves; *Cytispora Ribis* Ehr., *Dothidea ribaria* Fr., *Didymosporum truncatum* Corda, *Uredo Ribensi* Lk. sub Cœm., *Æcidium Grossulariæ* Dec., *Puccinia Ribis* Dec.—*M. J. B.*"

R. lacustre. 976., delete the last sentence, beginning "Sir W. J. Hooker," &c. *R. multiflorum* Kit. 980., to the list of *Synonymes*, add: "*R. vitifolium* Hort." 981., *R. prostratum*, its variety, and *R. resinosum*, Mr. Gordon informs us,

- have their fruit black, instead of red. In the latter, in the list of *Engravings*, for "our fig. 731.," read "our fig. 732."
- R. rigens*. Page 982., dele entirely; it being the same as *R. flóridum grandifórum*.
- R. punctátum*. The fruit, Mr. Gordon informs us, is black, not red. A specimen (*fig. 2475.*) has been sent us, from Mr. Pope of the Handsworth Nursery, near Birmingham, of a *Ribes* which strongly resembles *R. punctátum*. It is an evergreen, with small yellow flowers, and very sweet-scented."
- R. flóridum*. 986., to the "*Varieties*," after "*R. (n.) f. 2 grandifórum Hort.*," add: "*R. rigens Michx. Fl. Bor. Amer.*, i. p. 110., *Pursh Fl. Amer. Sept.* i. p. 136." *R. inébrians* and *R. cécum* have their fruit amber-coloured, not black.
- R. viscosissimum*. 987., to the list of *Engravings*, add: "and our *fig. 739.*"
- R. (a.) flavum*. 990., to the list of *Engravings*, add: "and our *fig. 2476.*"
- 991., in Mr. Gordon's list, to "*R. multifórum*," add: "syn. *vitifólium*."
- R. punctátum*. syn., for "prostrátum," read "glandulósum."
- To "*R. triflórum*," add: "var. *R. t. majus.*"

ESCALLONIA'CEÆ.

Escallónia. 694., add, after "*E. pulverulenta*:"—

"*E. glandulósa Hort.* There are plants of this species in the Horticultural Society's Garden, which have flowered there."

"*E. illinita Presl, Lindl. in Bot. Reg.*, t. 1900., and our *fig. 2477.*, has the leaves oblong, lanceolate, serrulate, clammy or varnished (whence the name); and corymbs 3-flowered, racemose. (*Lindl.*) This is an evergreen bushy shrub, covered all over with a clammy varnish; emitting an odour, according to Dr. Lindley, like melilot or fenugreek; but, according to others, like that of swine. The flowers are in terminal racemes, and are of a greenish white. The plant is a native of the mountains of Chili; but it appears the hardiest of all the species of *Escallónia* in British gardens."



SAXIFRA'GÆÆ.

Hydránga. 994., add to the paragraph headed "*Gen. Char., &c.*," "*Sphæ'ria sphærocéphala Schwein.* is found on the leaves."

UMBELLA'CEÆ.

Bupleúrum fruticósum. 997., to the "*Engravings*," add, "and our *fig. 2478.*"

HEDERA'CEÆ.

Hédera Hélix. Varieties. 1000., before "*The Varieties in British Gardens*," add: "A variety with white berries is mentioned by Theophrastus, Pliny, Virgil, and Dioscorides. Pliny also speaks of a kind which he calls '*pallentes hederæ*,' which Melmoth supposes to be the silver-striped."

1006. l. 17. from the bottom, before "*Plants*," insert: "The following fungi are found on the ivy:—*Sphæ'ria sinópica Fr.*, *S. microscópica Fr.*, *S. Mougeotii Fr.*; *S. trichélla Fr.*, on the leaves, and also on those of the willow; *S. Héderæ Sow.*, *S. hederæ'cola Fr.*, and *Dothídea Héderæ Fr.*, on the leaves; *Phóma Héderæ Desm.*—*M. J. B.*"



HAMAMELIDA'CEÆ.

Hamamélis virgínica. 1007. l. 4. from the bottom, after full stop, insert:

"Both sexes are in the Twickenham Botanic Garden. The male plant sometimes shows a few female flowers; but no male flowers have been observed on the female plant. The male blossoms appear in October, and continue through the winter; and the female flowers begin to open about November, and are very ornamental."

CORNA'CEÆ.

Córnus. Page 1010. line 12., after "204." insert: "The following fungi are found on plants of this genus:—On *C. flórida* are: *Peziza róseo-álba* *Schwein.*, *Tremélla virens* *Schwein.*; *Sphæ'ria nídulans* *Schwein.*, also on some American species. On the common cornel are: *Sphæ'ria coronáta* *Hoffm.*, also on the hawthorn; *S. mammillária* *Fr.*, also on the buckthorn; *S. Córni* *Mont.*, *S. cornícola* *Fr.*, and *Erýsipe tórtilis* *Lk.*, on the leaves; *Hystérium Córni* *K. et S.*, on *Córnus álba*.—*M. J. B.*"

LORANTHA'CEÆ.

Viscum. 1022. l. 2., add to the end of the paragraph: "It is generally supposed not to be now found on the oak; but, in March, 1837, a specimen was sent to us from the neighbourhood of Eastnor Castle, near Hereford, by Mr. D. Beaton, then gardener at Haffield. The mistletoe was of very vigorous growth; and Mr. Beaton informed us that there were several other plants of it on the same tree, one of which is of very great age, and forms a bush nearly 5 ft. in diameter. It has also been seen on the oak, and in great abundance on the willow, near Ledbury."

1025., for the paragraph beginning "The propagation of the mistletoe," &c., substitute:—

"Mr. Moss, a nurseryman at Malvern, near Worcester, has invented an excellent plan of propagating the mistletoe, by engrafting it standard high, on young apple and pear trees in his nursery. The next best stocks are strong-growing poplars and willows. The grafts should be put in the first or second week in May; and they should never be lower than 5 ft. from the ground, or higher than 10 ft. The mode of performing the operation is very simple: where the graft is not more than $\frac{1}{2}$ in. in diameter, an incision is made in the bark, into which a thin slice of mistletoe is inserted, having a bud and a leaf at the end. In grafting longer pieces, a notch should be cut out of the branch; the incision made below the notch, and a shoulder left on the graft to rest on the notch, in the manner of crown-grafting. It must be observed, that the spaces between the joints will not do for grafting; there must be a joint let into the bark of the stock. About the middle of May is the best time for budding; and the operation differs in retaining a heel of wood below the bud, for insertion. (*Gard. Mag.*, xiii. 206. 285.) The only fungus found on the mistletoe is *Sphæ'ria atrovirens* *H. et S.*"

Aúcuba. 1026., to the list of *Engravings*," add: "and our *fig.* 2479."

1026., after "App. I." &c., for "*L. europæ'us*," read "*Loránthus europæ'us*."

Add to paragraph headed "*Various other Species*:" "In the extreme south-west of Australia, at King George's Sound, occurs a similar exception to the almost universal law in the vegetable kingdom, that truly parasitical genera are incapable of growing in the earth. On all the coasts of Australia, the *Loránthus* is found



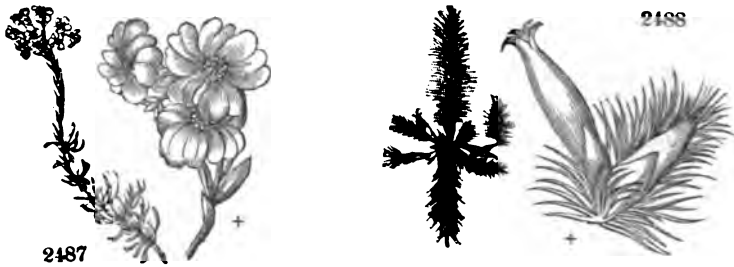

ERICA'CEÆ.

Erica. Page 1079. line 18., after full stop, insert : "The following fungi are found on plants of this genus : *Peziza erioloma* Fr., *Cenangium Ericæ* Fr. ; *Sphæria obturata* Fr., on the leaves ; *S. Ericæ* Fr., *Antennaria ericophila* Lk.—*M. J. B.*"

E. Tétralis. *Varieties*. 1079. E. T. 4 *Mackaiana*. Add to the end of the paragraph, omitting the full stop : "and is, perhaps, a hybrid between these species. The same plant, or one very like it, was found by H. C. Watson, on the Downs, near Truro."

"*E. Mackaii* was found by Maccallen, a schoolboy and the son of the inn-keeper at Roundstone, Cunnemara, about the same time that Mr. Mackay detected the *E. mediterranea*, in the same neighbourhood, in 1829. (*Comp. Bot. Mag.*, i. p. 159.)"

E. arborea. 1080., add to "*Spec. Char.*, &c. ." "It is found on Mount Etna, at 3800 ft. ; and in the Canaries, as high as 4200 ft. (*Comp. Bot. Mag.*, i. p. 51.)"

E. ciliaris. 1082. l. 3., add, after full stop : "and of Dorsetshire."

Calluna vulgaris. 1085. l. 5., after "sea," and omitting full stop, add : "though, in England, it is not found so high as 2500 ft."

1105., to the end of the directions for the culture of Cape heaths, add : "Two thirds of the *Ericæ* at the Cape, Mr. Anderson observes, are either in, or on the margin of, small rivulets falling from the Table Mountains ; which proves that they require a good deal of moisture to their roots, though it rots the stem. He adds that the best way to keep heaths in England is, in a pit made of turf, without fire, but covered with skeleton lights, mats, ferns, or reeds. When caught by the frost in a green-house, the treatment he recommends is, to light the fires, and, as soon as the warmth begins to take effect, to sprinkle the plants all over with the syringe."

Andrómæda. 1106., add to "*Spec. Char.*, &c. ." "The following fungi are found on this species :—*Týmpanis Andrómædæ* Fr., *Cenangium Andrómædæ* Fr. ; *Rhizisma Andrómædæ* Fr., on leaves ; *R. decolorans* Fr., on leaves of *A. figústrina* Schwein., *Phacidium Andrómædæ* Fr.—*M. J. B.*"

Cassiope. 1107., after "*Derivation*," add :—

"*Fungi*. *Hystèrium orbiculare* Ehr., and *H. grácile* Ehr., on leaves of *Cassiope lycopodioides* and *tetragona* ; *H. grácile* Ehr., with the former, on *C. lycopodioides*.—*M. J. B.*"

Lyonia. 1109., after "*Description*," add : "*Hýdnum olivaceum* Schwein. is found on *L. arborea* ; and *Exidia recisa* Fr. on that and the other species, though it is by no means peculiar to the genus."

L. marginata. 1110., add to *Engravings* : "and fig. 2489."

L. mariana. 1111., add to the *Variety*, *L. m. 2 oblonga* : "and our fig. 2490."

L. racemosa. 1111., add to list of *Engravings* : "and our fig. 2491."



Arbutus U'nedo. Page 1117., add: "*Derivation*. The specific name is said to be derived from *unus*, one, and *edo*, I eat; meaning that those who taste the fruit will find one enough."

A. hybrida. 1119., add to list of *Engravings*: "and this tree in our Volume of Plates."

A. Andrachne. 1120., add to list of *Engravings*: "our *fig.* 2492." l. 25., dele "a."

Statistics. 1121., after "There is a tree of this species in the Edinburgh New Botanic Garden, which was removed thither from the old garden in 1822, when it was 13 ft. high, with a trunk $10\frac{1}{2}$ in. in diameter

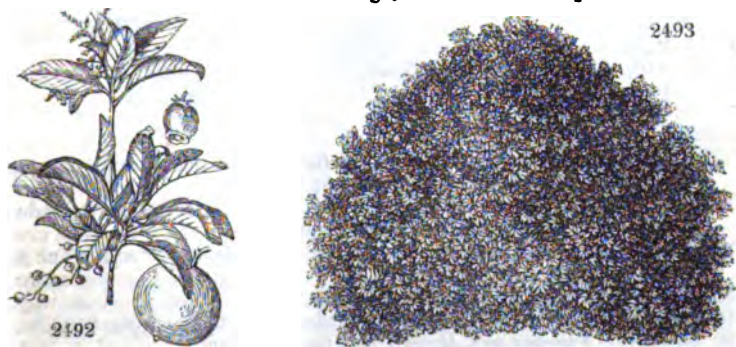

at 1 ft. from the ground;" add: "This tree, in September, 1836, was 19 ft. high, and the diameter of the branches from east to west was 23 ft. (See *fig.* 2493.) The age of this tree is not known, but it is supposed to be between 30 and 40 years."

1122., before App. i., introduce:—

"*A. speciosa*, and another species without a name, have been raised in the Horticultural Society's Garden, from Mexican seeds. They have also a species named *A. nepalensis*."

Arctostaphylos Uva-ursi. 1123., add to "*Spec. Char., &c.*:" "*Sphæria arbuticola* Sow. and *S. Arbuti* Fr. are found on this plant."

"*2. Variety. A. u. 2 austriaca* Lodd. is somewhat larger than the species."

Pernettia mucronata. 1124., transfer the cut and reference to *P. pilosa*.

Gaultheria Shállon. 1126. l. 24., dele the full stop, and substitute: "; the natives make this fruit into a kind of bread, which forms a great part of their winter store, and some of which was brought to England by Douglas."

Epigæa repens. 1127., add:—

"*Variety.*

"*2. E. r. rubicunda* Sweet Brit. Fl.-Gard., 2. ser. t. 384.— This new and very beautiful variety was raised by Mr. John Milne, of the Albion

Road Nursery, Stoke Newington. The flowers are considerably larger than those of the species, and of a rich pink. It is an abundant flowerer and quite hardy.

Rhododéndron. Page 1130., after the first paragraph, add: "*The fungi found on this genus are: Rhytisma Rhododéndri Fr., on R. camtschaticum; Didýmium crustaceum Fr., Urèdo Rhododéndri Dec.—M. J. B.*"

R. pónticum. *Varieties*. *R. p. 6 azaleóides*. 1131., add: "This variety was obtained from an accidental impregnation of an azalea with *R. pónticum*, in the Mile End Nursery. Messrs Chandler have a variety obtained in the same manner, which they call *R. p. frágrana*."

R. máximum. *Varieties*.

1134., after "*R. máx. 3 híbridum* Hook. Bot. Mag., t. 3454." insert:



2494

"and our fig. 2494." Add to the end of the paragraph: "The High Clere hybrids have been all raised from the seed of this species impregnated with the pollen of *R. arbóreum*."



2495



2496

R. Púrshii. 1135. There are plants in the Horticultural Society's Garden, under the name of *R. máximum álbum*.

R. punctátum. 1136., list of *Engravings*, for "our fig. 935.," read "our fig. 2495."

R. p. 2 május. 1137., add: "and our fig. 935."

R. nudiflórum. *Varieties*. 1141., *R. n. 2 rútilans*, add: "and our fig. 2496."

R. viscòsum. *Varieties and Hybrids in Loddiges's Catalogue for 1836*. 1143., to "17 Cartònia," add: "and our fig. 2497."

1144. l. 3., for "73 miniàta," read "73 mónica."

R. Rhodóra. 1145., in the list of *Engravings*, for "our fig. 951.," read "our fig. 2498."

Kálmia. 1151., to paragraph headed "*Description*," add: "Hystèrium *Kálmia* Schwein. is found on plants of this genus."

Menzièria. *M. globulàris*. 1153., add, after the list of *Synonymes*: "*Engraving*. Our fig. 2499."

Azàlea procúmbeus. 1154., to the list of *Engravings*, add to "our fig. 964.:" "from *Lodd. Bot. Cab.*, and fig. 2500. from the *N. Du Ham.*"

Lèdum. 1155., add to "*Description*:" "On these plants are found: *Peziza Lèdi A. et S.*; *Phacídium Lèdi Schwein.*, *Hystèrium Lèdi Fr.*, *H. sphæriòides A. et S.*, and *Urèdo Lèdi A. et S.*, on the leaves.—*M. J. B.*"

Vaccínium. 1156., after "*Description*," add:—

Fungi. On *V. Vitis idæ'a*: *Sphæria Vaccínii Sow.*, *S. cytispòrea Fr.*, *S. stemmàtea Fr.*, *Dothídea látitans Fr.*, *Phacídium Vaccínii Fr.*, *P. leptidèum Fr.*, *Hystèrium melaleucum Fr.*, *Helminthospòrium Vaccínii Fr.*, all but the



2497

first and last on leaves. On other species: *Sphæria conferta* Fr., on the leaves of *V. uliginosum*; *Rhytisma Vaccinii* Fr., on leaves of *V. frondosum*; *Hysterium degenerans* Fr., on twigs of *V. uliginosum*; *H. maculare* Fr., *Didymium melanopus* Fr., *Stemonitis ascyrioides* Sommer. (but on other plants), *Erysiphe Myrtilli* Fr., and *Urredo Vacciniorum* Dec., on the leaves.—*M. J. B.*"
Vaccinium grandiflorum. Page 1162., add to the list of Engravings: "and fig. 2501. from Watson."
V. padiflorum. 1164., add to list of Engravings: "fig. 2502. is from a specimen of this species grown in the Hammersmith Nursery."

Oxycoccus. 1168., add to "Description:": "Sphæria cinnata Fr., Phacidium Oxycoccus Fr., on leaves; Hysterium Oxycoccus Fr., on the leaves.—*M. J. B.*"

Half-hardy ligneous Species of Ericaceæ. 1173., add to these:—

"*Cyrilla racemosa* N. Du Ham., 1. p. 215. t. 46., and our fig. 2503; *C. racemiflora* L.; *C. caroliniana* Michx., Pursh, Bot. Mag. t. 2456; *Andrómèda plumata* Marsh. Cat. Arb., p. 13; *Itea caroliniana* L'Hérit. Sert. Ang.; *I. Cyrilla* Swt.; *I. racemiflora* Lam. Hort. A tree 15 ft. or 20 ft. high, with a straight



2498



2499



2500



2501

trunk, and bushy head. The flowers are white, and hang in bunches of long pendent racemes. The capsules when ripe are of a greyish brown. It flowers in the middle of summer, and retains its blossoms a month or six weeks, but the seeds are rarely ripened in Europe. It is a native of Brazil,



2502



2503

but has also been found in the United States, in the Carolinas, in marshes, and on the banks of rivers."

Page 1191., before Chap. LXXIII. insert : —

MYRSINA'CEÆ.

"*Myrsine africana* Lin. Spec., 285.; *M. glabra* Gertn. Fruct., i. 282; *Vitis idæa aethiopica* Comm. Hort., i. 123. t. 164.; *Buxus africana* Pluk. Phyt., t. 80. f. 5., and our fig. 2504. Flowers axillary, in threes, on short peduncles. Corolla pale, rugged with testaceous dots, ciliate, closed. Stamens opposite to, and not alternate with, the segments of the corolla. Stigma pencil-shaped. Berry of the same form and shape as that of *Uva-ursi*, blue. Nucleus of the same shape. Seeds 6, placed beyond the receptacle, in a ring; only one or two ripening. Leaves elliptic, acute. Flowers yellow. (Mart. Mill.)



2504



2505

A native of the Cape of Good Hope, introduced in 1691. A plant has stood at Bayswater for several years, with very slight protection.

Mangifera Milleriana Pers., Bot. Mag., t. 1858.; *Sideroxylon mite* L.; *Myrsine nitida* Spr.; and our fig. 2505.; is an evergreen low tree, a native of the Cape of Good Hope.

SAPOTA'CEÆ.

Bumelia lycioides. 1193., add to the list of *Eragravis*: "and fig. 2506., of the natural size."

1194., add to paragraph headed "*B. salicifolia*," omitting the full stop: "as shown in fig. 2507."

EBENA'CEÆ.

Diospyros. 1194. add to "*Spec. Char., &c.*:" "*The fungi are: Sphæria Diospyri Schwein., Dothidea orbiculata* Fr., and *D. Diospyri* Fr., on the leaves of *D. virginiana*. — *M. J. B.*"

1197., add to "*Other Species,*" &c.: "*D. intermedia, D. digynia,* and *D. stricta* are in the Horticultural Society's Garden."

OLEA'CEÆ.

Ligustrum. 1198., add to "*Gen. Char., &c.*:" "*Téléphora limitata* Chaill., *Sphæria profusa* Fr., 8. (*Dehazea*) *Ligustri* Derm., are found on plants of this genus. — *M. J. B.*"

L. spicatum. 1201., in the list of *Synonymes*, delete "*L. nepalense* var. *glabrum*," and reference. After the paragraph headed "*Spec. Char., &c.*" add:— "*Variety.*"

"† *L. s 2 glabrum* Hook. in Bot. Mag., t. 2921. — This is a native of the mountains

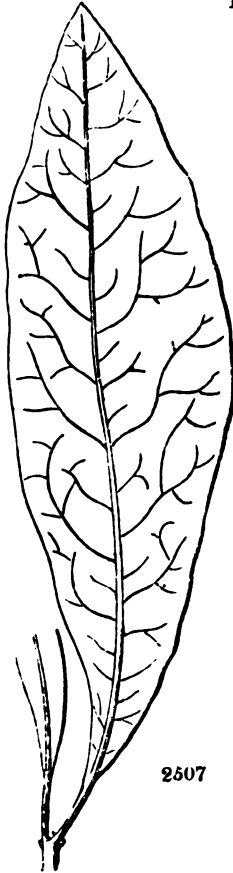

2507



2506

of Nepal, where it is called *Goom-gacha*, and where it grows to be a considerable tree, much branched, the trunk and limbs covered with warts, but the younger branches glabrous. It produces, from April to June, profuse clusters of whitesweet-smelling flowers; which are succeeded by small oval berries of a brilliant blue colour, and covered with a beautiful bloom. It was discovered by Dr. Wallich, who sent a plant to the Glasgow Botanic Garden, where it flowered for the first time in August, 1828."

L. lucidum. Page 1202., add to the paragraph headed "L. l. 2 *floribundum*," after "Donald's Cat.:" "and our fig. 2508."

L. japonicum. 1202., add to paragraph: "There are now (1838) plants of this species in the Horticultural Society's Garden, which have been raised from seed. Mr. Gordon thinks that they approach *L. lucidum*, but they are at present too small to enable us to speak decidedly."

Phillyrea. 1203., add to "Gen. Char., &c.:" "*Æcidium Phillyreae* Dec. is found on the leaves."

Olea. 1207. l. 7. from the bottom, add: "*Sphæ'ria O'leæ* is found on the leaves; and *Agáricus olearius* Dec., remarkable for its luminosity, on the trunk."

O. capénsis. 1208., after "*Bot. Reg.*, t. 613.," add: "and our fig. 2509."

"■ *Notela'a ligustrina* Vent. Ch., 256., and our fig. 2510., the southern olive, is a very handsome evergreen shrub, greatly resembling an olive; a native of Van Diemen's Land. Introduced in 1807."



2508



2509



2510

Syringa. 1209. l. 16., after full stop, add: "*Agáricus redúctus* Fr. is found on the leaves; and *Dacrýmyces Syringæ* Fr., *Sphæ'ria oculata* Fr., *S. Syringæ* Fr., and *Conóplea olivácea* Pers., the last being also occasionally on the beech.—*M. J. B.*"

S. Josikæ'a. 1210., add to list of *Engravings*: "Botanist, t. 24."

S. Emódi. 1212., for "our fig. 1041.," read "our fig. 1042."

Fráxinus. 1214., after the paragraph headed "*Gen. Char., &c.*," insert:—"*Fungi. Agáricus Gúnneri* Fr., *Polýporus imbricátus* Fr., *P. Fráxini* Fr., *Peziza fascicularis* A. et S., *P. connivens* Fr., *Týmpanis Fráxini* Fr., *Stictis sphæràlis* Fr., *Exídia lobàta* Sommerfelt; *Scleròtium scutellàtum* A. et S., on

leaves, but on other plants also; *Sphæria candida* Schwein., on *Fraxinus pubescens*; *S. tremelloïdes* Schum., *S. spondylina* Fr., *S. eunomia* Fr.; *S. excipuliförmis* Fr., also on the maple; *S. spina* Schwein.; *S. ocellata* Fr., also on willows; *S. corticis* Pers., also on the poplar; *S. pruinosä* Fr., *Dothidea Fraxini* Fr., *Hystèrium Fraxini* Pers., *Hyphèlia nigrèscens* Fr., *Septària Fraxini* Fr.; *Æcidium Fraxini* Schwein., on leaves.—*M. J. B.*"

Page 1217., to the paragraph headed "*F. e. 4 aurea*," add: "In the park at Clervaux, near Chât-Merault, is a tree of this species, which, when 34 years planted, was 29 ft. high."

F. excelsior. 1217., to the paragraph headed "*F. e. 8 purpurascens*," add: "There is a plant in the Horticultural Society's Garden, under the name of *F. purpurea*."

Statistics. 1225., add to "*Recorded Ash Trees in England*:" "In the *Gentleman's Magazine* for 1804, p. 909., a curious ash tree is figured, with two trunks, parted, and quite distinct at a short distance from the root, and afterwards joined again. This tree, which grew at Shirley Street, near Birmingham, was split to cure a rupture in the child of a farmer in the neighbourhood; and it is supposed that the two parts, thus separated, became each covered with bark, and have thus formed two trunks. The trees that have been tried for this purpose are preserved with great care; as the belief is that, if the tree is felled, the rupture returns, mortifies, and kills the person formerly cured. Mr. Fennel, in an article on the ash, in the *Mirror*, vol. xxv. p. 212., mentions a remarkable ash which grew at South Runeton, in Norfolk, and which, when cut down, though only 45 ft. high, was found to have a root 133 ft. in length."

1226., add to "*Recorded Ash Trees in Scotland*:" "Mr. Fennel mentions 'an aged ash, known by the name of the Maiden of Midstrath, at Birse, in the north of Scotland, which perished by the winds in 1833, and was supposed to have existed ever since the end of the sixteenth century. At the time of its fall, the circumference of its trunk was found to be 21 ft. near the earth, and 18 ft. at the elevation of 9 ft. from the ground. Another, at Dumbarton, is said to have been 17 ft. in circumference.'"

1227., add to "*Recorded Ash Trees in Ireland*:" "Mr. Fennel records 'one at Galway, in Ireland, the circumference of which is said to have been 42 ft.; another Irish specimen is mentioned by Arthur Young, as having, in the course of 35 years, nearly attained the height of 80 ft.' (*Mirror*, vol. xxv. p. 212.)"

Existing Ash Trees, &c. 1227. l. 23., for "above," read "in p. 1225."

1227. l. 35., after "head," add: "circumference of the trunk at 3 ft. from the ground, 31 ft.; and at 6 ft., 16 ft. 6 in.; height about 90 ft."

F. (e.) angustifolia. 1229., insert: "*Engraving*. Our *fig. 2511.*"

F. lentiscifolia. 1231., for "*fig. 1054.*," substitute "*fig. 2512.*"

F. eptiptera. 1237., add to the list of *Engravings*: "and the plate of this species in our Volumes of Plates."

1238. l. 3., for "30," read "50."
l. 6. for "15," read "20."

1240., last line, for "We have not heard of this species being in Britain," read: "Mr. Gordon informs us that there is a fine tree of this species in the Surrey Zoological Garden, and another in Buchanan's arbo-retum, Camberwell."

1246., in the alphabetical list of *Fraxinus* and *O'rnus*, under "*F. juglandi-*





2512

folia," turn l. in "láncea;" and under *F. am. juglandifolia*, in the next column, for "láncea," read "epiptera."

Page 1246. last line but 3, dele "Theophrásti," and "am. Theophrásti;" this kind being the same as nána.

1247., make the same alterations as in p. 1246.

JASMINA'CEÆ.

Jasminum. 1248., after "*Gen. Char., &c.*," add: "Puccinia Jasmini Dec. is found on the leaves of *J. fruticans*."

APOCYN'A'CEÆ.

Vinca. 1254., add to "*Gen. Char., &c.*:" The following fungi are found on these plants:—*Sphæria agglomerata Pers.*, *Uredo Vincæ Dec.*, and *Puccinia Vincæ Berk.*, on the leaves.—*M. J. B.*"

1256., before App. I. add:—

"*Vinca acutiflora* Bert. Leaves ovate, acute at both ends; margin glabrous. Segments of the calyx narrow, linear, naked. Segments of the corolla oblique, ovate-acuminate. Flowering in March and April. We are indebted for an account of this species to Signor G. Manetti, of Monza."

ASCLEPIADA'CEÆ.

1258., after the paragraph commencing "*The Half-hardy Species of Periploca*," insert:—

"*Physianthus albicans* Hort., *P. undulatus* Hort., is a hardy climber, from South America, which has stood out in the Vauxhall and Fulham Nurseries without any protection."

BIGNONIA'CEÆ.

Bignonia. 1259., add to "*Gen. Char., &c.*:" *Sphæria sacculus* Schwein., *S. Bignoniæ* Schwein., and *Dothidea Bignoniæ* Fr.—*M. J. B.*"

Técoma radicans. *Varieties*. T. r. 2 *máior*. 1259., for "a paler scarlet," read "darker scarlet."

SOLANA'CEÆ.

Solanum. 1266., for "CRABÓWSKIA," read "GRABÓWSKIA." Add to "*Gen.*"

Char., &c.:" "The fungi are :
Sphæria Dulcamaræ Schw."
S. bonariense. Page 1268., add to end
of paragraph : "It stands out
in the open ground in the Hor-
ticultural Society's Garden.
S. Balbisii Dun. 1268., add : "*S. decúr-
rens* Balb., and our fig. 2514.,



2513



2514

syn. *S. brancæfolium* Jacq., *S. mauritiànium* Willd., *S. viscosum* Dec."
S. littorale Hort. 1269. There is a species under this name in the Hor-
ticultural Society's Garden, which Mr. Gordon thinks
tolerably distinct.



2515



2516



2517

Lycium lanceolatum. 1272., add to list of *Engraving*s : "and our figs. 2513, and 2516."
L. turbinatum. 1272., add to list of *Engraving*s : "and
fig. 2517."

SCROPHULARIACEÆ.

1277., add to the *Half-hardy Plants* of this order :—
Penstemon Scouleri Dougl., *Bot. Reg.*, t. 1277., and
our fig. 2518., is a half-shrubby evergreen plant, dis-
covered by Douglas at the Kettle Falls of the Columbia
River, and introduced in 1827.

P. atropurpurea G. Don, *Swt. Fl. Gard.*, t. 235., is a
native of Mexico, also half-shrubby ; and both are well-
deserving a place in rockwork, on account of the great
beauty of their purple flowers, which are produced
in profusion from May to August, or later.

LABIACEÆ.

Thymus grandiflorus. 1278., add : "and our fig. 2515."



2518

Prostanthèra lasianthos. Page 1284.,
add: "and our fig. 2519."

VERBENA'CEÆ.

Vitex inctsa. 1286., add: "This plant
is in the Horticultural So-
ciety's Garden."

Clerodéndrum speciosissimum. 1286.,
add to the paragraph: "This
has since been discovered to
be the same as *C. squamatum*
Vahl, Bot. Reg., t. 649. A
native of China; and intro-
duced in 1790."

Aloysia citriodóra, in the garden of
Sir Walter Raleigh's house,
at Youghal, is 25 ft. high,
with a stem 3 in. in dia-
meter.



2519

PLUMBAGINA'CEÆ.

Plumbago capensis. 1287., introduce after
"Bot. Reg.", t. 417.: "and our
fig. 2520."

CHENOPODIA'CEÆ.

Atriplex Halimus. 1289. This species
is abundant in a wild state about
King George's Sound, on the ex-
treme south-west of Australia, and is eaten by the settlers as an



2520

agreeable food.

Kochia prostrata. 1291., add: "This species is quite hardy in the Horticultural
Society's Garden."

POLYGONA'CEÆ.

Tragopodium. 1294., before the paragraph headed "*T. púngens*," introduce:—
"*T. maritima* Doug. There are plants, raised from seeds sent home by
Douglas, in the Horticultural Society's Garden."

LAURA'CEÆ.

Laurus nobilis. 1298. l. 1., add, after "Tauria:" "It is not really wild
in any part of Sicily, though it grows in hedges near the towns.
(*Comp. Bot. Mag.*, i. 51.)

End of the paragraph, after "Knights of the Round Table," add: "The
flowers of the sweet bay afford the best kind of honey, and are nume-
rously frequented by bees. The blackbirds, in winter, are very fond of
the berries. (*Host Fl. Aus.*, ii. p. 66.)"

L. Sássafras. 1303., before "Statistics," insert:—

"*Insects and Fungi*. The *Papilio Ilioneus* Sm. et Abb. Ins. of Georgia, t. 2.,
and our fig. 2521., the black swallow-tail butterfly, in its larva state, feeds on
the leaves of this tree. The fungi are: *Calócera Láuri Brot.*, *Hystèrium Láuri*
Fr., *Sphæ'ria Sássafras* Schwein., *S. pentagóna Pers.*, *Actinocládium penicillus*
Fr., and *Sphæ'ria conférta* Schwein.; which last is also found on *L. Benzòin*."



PROTEA'CEÆ.

Page 1306., add, after the paragraph headed "*Banksia littoralis*:—" *B. latifolia* R. Br., Bot. Mag., and our fig. 2522., is a tree growing to the height of 30 ft.; a native of New South Wales; introduced in 1820.

THYMELA'CEÆ.

Daphne Mezereum. 1308. l. 15. from the bottom, introduce: "*Dothidea Mezerei* Fr. is found on the leaves of this plant."

ELEAGNA'CEÆ.

Elæagnus hortensis orientalis. 1322., add to the last line: "Mr. Lambert has, in his garden at Boyton, four plants of this *Elæagnus*, raised from seeds received from Persia, which, in 1836, were 30 ft. high."

E. conferta. 1324., add: "There is a plant in the Horticultural Society's Garden, which has stood against a wall in the open air for six or seven years, but which is generally killed down to the ground every winter."

In fig. 1205., dele the germen placed horizontally at the bottom of the plate."

Hippophae Rhamnoides. 1325. l. 4. from the bottom, after full stop,

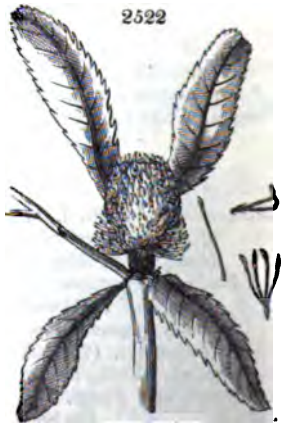

add: "Professor Link observes that a traveller from the Island of Rügen to Geneva will only find this plant at those two points, where it grows abundantly, but is not found in the whole intermediate space. (*Jam. Journ.*, vol. xii. p. 305.)"

ARISTOLOCHIA'CEÆ.

Page 1328. line 5. from the bottom, add: "*Æcidium Aristolochiæ Schleich.* is found on the leaves of both species."

EUPHORBIA'CEÆ.

Euphòrbia spinòsa. 1331., for "our *fig.* 1209.," read "our *fig.* 1213."

Add at the bottom of the page:—

"*E. Myrsinites* and *E. rígida* are in the Horticultural Society's Garden."

Búrus sempervirens. 1338. l. 8. from the bottom, after full stop, add: "The most interesting garden of this kind now existing in England is probably that in the grounds at Holland House. It is of considerable size, and consists of two parts, divided by a high closely clipped hedge. The larger portion contains parterres of embroidery formed of box, in the manner shown in *fig.* 1217.; and in the smaller garden is the crest of the family, a fox, with a legend below, all formed of box."

1340., add to last line, omitting full stop: "as are *Sphæria Búxi Desm. in Litt.*, *S. atrovirens*, *S. búxicola Fr.*, *Dothidea puccinioides Fr.*, *Fusicporum Búxi Fr.*, and *Blennòria Búxi Fr.* *Sphæria sanguinea* var. *cicatricum Berk.* is found on the bark.—*M. J. B.*"

1341., after the word "*Statistics*," insert: "The largest box trees in England are, probably, two at Eyford House, near Stow in the Wold, Gloucestershire. The height of both trees is above 32 ft., and the branches spring from the trunks at about 12 ft. from the ground; the trunks are rather more than 2 ft. in circumference; and the diameter of the space covered by the branches of the largest tree is 20 ft., and by those of the smallest about 19 ft."



2523



2524



2525

Half-hardy Species of Euphorbiaceæ. 1342.

Plagiánthus divaricatùs. Add: "and our *fig.* 2524."

"*Cròton rosmarinifòlia* Cunn., and our *fig.* 2523., is a native of New Holland, which was introduced in 1824.

"*Adèlia Acidòton* L., and our *fig.* 2325., is quite hardy among a group of American *Ericaceæ* at Syon. It is a native of Jamaica, and introduced in 1768."



URTICA'CEÆ.

M. nigra. Page 1345., add to l. 12. : "Fig. 2526. is a sketch of a remarkable black mulberry tree at Canterbury, growing on the land formerly used as a garden by the monks of St. Augustine, near the Gothic gateway yet remaining of that monastery. Mr. Masters, nurseryman of Canterbury, who kindly sent us the drawing from which fig. 2526. was



engraved, conjectures it to have been planted by the elder Tradescant, who was once gardener to Lady Wootton, at Canterbury. No one remembers to have seen the original trunk in an upright position, and the two arms shown as springing from it have now become large trees. The very remarkable mulberry at Battersea, figured in our Volume of Plates, is supposed to be 300 years old."

M. alba. Varieties. 1349. *M. a. Morettiana* is in the Horticultural Society's Garden. *M. a. macrophylla* Mr. Gordon thinks different from *M. hispánica*, the former having much the larger leaves.

1358., add to the paragraph entitled "Insects and Diseases.:" "Mr. Berkeley mentions *Agáricus rhagadiosus* Fr., *Polyporus Móri* Fr., and *Stictis coccinea* Fr., as the fungi on *Mórus*."

Broussonétia papyrifera. Varieties. 1361., add :—
"■ *B. p.* 3 fructu álbo has the fruit white."

1362., before "Statistics," add : " *Sphæria peregrina* Mont. is found on this plant.

Bòrya acuminàta. 1371., add to paragraph headed "Spec. Char., &c.:"
"Mr. Gordon informs us that *B. acuminàta* grows much larger than *B. ligústrina*, and bears a considerable resemblance to a Persian lilac."

Ficus. 1370., add to the "Statistics.:" "In Suffolk, at Stutton Rectory, 90 years old, it is 30 ft. high, with two stems, each about 3 ft. 6 in. in circumference."

ULMA'CEÆ.

Ulmus campestris. 1378., add to "Varieties.:"—

"■ *U. c.* 19 *nàna* Hort. is, Mr. Gordon informs us, a very distinct variety, not growing above 2 ft. high in 10 or 12 years. A plant in the Horticultural Society's Garden, when taken up to be removed, was found to have a root running along the surface of the ground, which measured between 7 ft. and 8 ft. long."

1390., insert before "Recorded Elms.:"—

"The Fungi on the elm are : *Agáricus ulmàrius* Bull. (*E. of Plants*, 15924.),
A. vulpinus Sow. (*E. of Plants*, 16006.), *Polyporus ulmàrius* Fr., *Peziza*

leonina *Schwein.*, *P. fibuliformis* *Bolt.*, *Sphæria stellulata* *Fr.*; *S. dissépta* *Fr.*, but not confined to elms; *S. ciliata* *Pers.*, found also on the alder; *S. melastrôma* *Fr.*, *S. hypodermia* *Fr.*, *S. naucôsa* *Fr.*; *S. álmea* *Schwein.*, on *Ulmus* americana; *S. cubicularis* *Fr.*, *Cytispora carbonæa* *Fr.*, *Dothidea Ulmi* *Fr.* (*E. of Plants*, 16467.), *D. astrôidea* *Berk.*, *Rhytisma Ulmi* *Fr.*, *Asterôma Ulmi* *Grev.*, *Hyphelia fûsca* *Fr.*, *Tipularia fulva* *Chev.*, *Septaria Ulmi* *Fr.*, on leaves.—*M. J. B.*"

Page 1394. line 6., for "Gredington," read "Gredlington."

l. 29., for "Stoakpole," read "Stackpole."

l. 42., for "Harwood," read "Howard."

Statistics. 1403. l. 11., for "the Oxford Botanic Garden," read "Magdalen College Grove;" and for "2 ft. 10 in.," read "10 ft."

U. americana. 1406., add to "*Varieties*:"—

"*U. a. 5 foliis variegatis* *Hort.*—There are trees in the Horticultural Society's Garden."

1407. l. 19., after "*(Michaux.)*," insert: "It was under a magnificent tree of this species, that Penn signed the treaty with the American Indians."

JUGLANDACEÆ.

Juglans. 1422., after "*Description*," add:—

"Numerous fungi are found on trees of this genus, the principal of which are: On *J. régia*, *Polyporus alligatus* *Fr.*, *Peziza roseola* *Fr.*, *Sphæria tubulina* *A. et S.*, also on the fir; *S. lixivia* *Fr.*, *S. escharoides* *Fr.*, *S. Juglandis* *Fr.*; *S. leptostyla*, on leaves; *S. juglandicola* *Fr.*, on leaves; *Mûcor Juglandis* *Fr.*, on nuts; *Bôtrytis atrata* *Fr.*, also on horsechestnut. On *J. nigra*, or some American species, are: *Hýdnum Himántia* *Schwein.*, *Peziza Erinæceus* *Schwein.*, *Cypella péndula* *Fr.*, *Sphæria scoparia* *Schwein.*, *Hystèrium pulicære* β *Juglandis* *Schwein.*—*M. J. B.*"

Carya álba. 1448. l. 12., add to paragraph: "*Agáricus niger* *Schwein.*, and *Sphæria juglandicola* *Schwein.*, are found on this species."

Pterocarya caucásica. 1452., add to "*Identification*:" "*Mey. Verz. Pflanz. Cauc.*, p. 134."

l. 31., for "at the foot of Caucasus," read "on Mount Caucasus, at an elevation of 900 ft."

SALICACEÆ.

Sális. 1484., before "*The Study of the Species*," insert:—

"*Fungi*. *Agáricus epichýsium* *Pers.*, *A. Dunáli* *Dec.*, *A. salcinus* *Pers.*; *A. úrbicus* *Fr.*, at roots; *A. translúcens* *Dec.*; *Cantharéllus cupularis* *Fr.*, on *S. phylicifolia*; *Dædalea saligna* *Fr.*, *D. suavèolens* *Fr.*; *D. rubescens* *A. et S.*, on leaves; *Polyporus fumôsus* *Fr.*, *P. suavèolens* *Fr.*, *P. odôrus* *Fr.*, *P. conchatus* *Fr.*, *P. salcinus* *Fr.*; *Hýdnum crustosum* *Pers.*, also on pine; *Peziza poriaeformis* *Dec.*; *P. aménti* *Batsch*, on catkins; *P. iánthina* *Fr.*, *P. salicella* *Fr.*, *P. flexella* var. *Fr.*, *Ditiola sulcata* *Fr.*, *Týmpanis saligna* *Fr.*, *Cenangium fuliginosum*, *Stictis Lecanora* *Fr.*, *S. pelvicola* *Fr.*, *Cryptomyces Wauchii* *Grev.* (*E. of Plants*, 16289.), *Tremella indecôra* *Sommerfeldi*, *Exidia recisa* *Fr.*, *Sclerôtium salcinum* *Fr.*, *Sphæria cónfluens* *Tode*, *S. corrugata* *Chev.*, also on poplar; *S. bullata* *Pers.*, also on hazel; *S. subcutanea* *Wahl.*, on *S. phylicifolia*; *S. salicella* *Fr.*, *S. tessella* *Pers.*; *S. salicina* *Fr.*, also on the vine; *S. centrípeta* *Fr.*, *S. dolosa* *Fr.*, *S. acervális* *Moug.*, *S. byssisèda* *Tode*; *S. papillata* *Schum.*, on *Sális fragilis*; *S. mastoidea* *Fr.*, *S. truncata* *Fr.*, *S. hæmatorrhyncha* *Somm.*, *S. palina* *Fr.*; *S. capræ* *Dec.*, and *S. salicicola*, on leaves; *Sphaeronomæa cylindricum* *Fr.*, also on the oak; *Cytispora xanthosperma* *Fr.*; *C. fûgax* *Fr.*, also on the hazel; *Phoma saligna* *Fr.*, *Dothidea paradoxâ* *Fr.*, *Rhytisma máximum* *Fr.*; *R. salcinum* *Fr.* (syn. *Xyloma salcinum* *Grev.*, t. 118., and *E. of Plants*, 16490.), on leaves; *Phacídium laciniatum* *Fr.*, on leaves; *P. carbonæum* *Fr.*, *Hystèrium ellipticum* *Fr.*; *H. versicolor* *Fr.*, on *S. hastata*; and *S. arbúscula*, *Apiosporium Sális* *Kz.*, *Helminthosporium simplex* *Kz.*;

H. clavuligerum Fr., on *S. álba*; *Sporótrichum fúlbum* Fr., *S. salicinum* Fr.; *Fusispórium ebúlliens* Fr., on *S. mollíssima*; *Nemáspora incarnáta* Desm., *Conóplea cinérea* Pers.; *Urèdo míxta* Lk., *U. salicèti* Schlecht., *U. epítea* K., *U. capreàrum* Dec., and *Puccínia Sálicum* Lk., on leaves.—*M. J. B.*"

S. babylónica. Varieties. Page 1514., after "*S. b. Napoleóna*," add: "May 10th, we received specimens from the brickfield at Hanwell, Pope's Villa, and the Twickenham Botanic Garden, in blossom; all with female flowers."

S. nigra. 1529., add to the paragraph headed "*Spec. Char., &c.*:" "In fig. 2527. *a* shows *S. nigra*, and *b* *S. ligústrina*."

S. versicolor. 1541., add to list of *Engravings*: "our fig. 2528."

1602. After "*App. i.*," add:—

"*S. coluteoides* Mirb. Mus., vol. xiv. t. 20., and our fig. 2529., has the



2527



2528



2529

leaves elliptic, blunt, terminated by small mucros, quite entire, glabrous, on short footstalks, wedge-shaped and oblique at the base, glaucous beneath. Male catkins appearing with the leaves, oblong-conical, interrupted at the base. Stamens 8—12. Filaments unequal. (*Mirb.*) A shrub or tree, a native of Senegal, where it was discovered by M. Pérodet. Leaves from $\frac{1}{2}$ in. to 1 in. in length, and from 3 to 5 lines in breadth; rounded at the tip. Female not known. (p. 463.)"

1602., add to *Kinds of Sáliz not introduced*:—

S. síchénsis Hort. is mentioned in the *Mém de l'Acad. des Scien. Petersb.*, as quoted in *Ann. des Scien. Nat.*, 2d ser., t. iii. p. 237.

Populus. 1637. l. 18., after "surface" add, omitting full stop: "; the buds are also without gum."

Last line but one, add: "The flavour of the herbage of *P. nigra* and *P. fastigiáta*, when bruised, is very peculiar; and the smell of a dried branch resembles that of the common walnut."

1638. l. 9. from the bottom: "The following list of fungi found on the species of this genus, has been sent to us by the Rev. M. J. Berkeley:—*Agáricus Battárræ* Fr., *A. haustelláris* Fr., *Dædálea angustáta* Fr., *Polýporus popúlinus* Fr., *P. castàneus* Fr., *Theléphora flocculénta* Fr., *T. rósea* Pers., *T. suavéolens* Fr., *Peziza sceptrum* Batsch, in poplar groves; *P. corticális* Pers., also on the oak; *P. spadíceá* Pers.; *P. cáucus* Reb., on catkins; *Stíctis ocelláta* Fr., *S. farinósa* Fr.; *S. rhodoleúca* Somm., also on pine cones; *Sclerótium inclúsum* S. et K., *S. popúlineum* Fr., on leaves; *S. rhizomórpha* Fr., *S. protúberans* Fr., *Sphæria lignióta* Fr., *S. aneirina* Somm., *S. opérta* Schmidt, *S. popúlina* Pers., *S. mütíla* Fr., *S. ceuthocárpa* Fr., *S. exilis* A. et S., *S. maculáris* Fr., *S. tremulæ'cola* Fr., *S. frondícóla* Fr., on leaves; *Cytíspora chrysoépérina* Fr., on leaves; *Phóma filum* Fr., *Dothídea sphæróides* Fr.; *Phacídium fimbriátum* Schmidt., on leaves; *Hystérium emérgens* Fr., *Didýmium sérpula* Fr., *Perichæna popúlina* Fr., *Hyphélia rósea* Fr.;

Perisporium maculare Fr., *Urèdo allóchroa* Lk., *U. cylíndrica* Strauss (also on the birch), and *U. ægérina* Schlecht., on leaves.

P. álba. Page 1639., add to "*Spec. Char.*:" "The leaves of *P. álba*, and all its varieties, are not folded in the bud, and the buds are without gum "

P. tremula. *Geography*. 1647. l. 9., add, after full stop: "It is found on Mount Etna, at the height of 5500 ft. (*Com. Bot. Mag.*, i. p. 91.)"

P. fastigiata. 1661. l. 10., dele "said to be;" and l. 11., after "Himalayas," add, "where it was found by Dr. Royle;" and for "to have been," read "was." l. 16. after full stop, add: "Near Pavia was till lately a very large poplar, into which Francis I. struck his sword, after losing the battle of Pavia."

1669. l. 13., add: "The wood is little used in Britain; but in Hampshire, Vancouver tells us, thin strips or shavings of it are employed for making chip hats. (*Survey, &c.*, p. 300.)"

P. balsamifera. 1673., add to "*Engravings*:" "and our fig. 2530. from *Pall. Ross*."



BETULACEÆ.

A'lnus. 1686., add to the paragraph headed "*Accidents, Insects, and Diseases*:" "The following list of fungi on the common alder, and on plants of this genus, has been sent to us by the Rev. M. J. Berkeley:—*Agáricus salicinus* β *berýllus* Pers., *A. alnicola* Fr., *Merúlius cónfluens* Schwein., *M. níveus* Somm., *M. crispátus* Müll., *Dædálea móllis* Somm., *Polýporus Neesii* Fr., *Hýdnum pudorinum* Fr., on *A'lnus incána*; *H. vírídè* Fr., *H. stipátum* Fr., *Rádulum péndulum* Fr., *Theléphora álnea* Fr., *Clavária contórta* Holmsk., *Peziza urcæolus* A. et S., *P. phiala* Schum.; *P. complanáta* Fr., on *A'lnus cordáta*; *Týmpanis álnea* Fr., *Tremélla fimbriáta* Pers., *Sclerótium oliváceum* Fr., *Nidulária denudáta* Fr.; *Sphæ'ria lútea* A. et S., also on the willow; *S. verrucélla* Fr., *S. suffúsa* Fr., *S. diatrýpa* Fr.; *S. frit* Fr.; also on *Negúndo fraxinifólium*; *S. thelébola* Fr., *S. mucósa* Fr., *S. ditopa* Fr.; *S. álnea* Fr., on leaves; *Cytispora átrovirens* Fr., *Dothídea álnea* Fr. and *D. rhytismóldes* Fr., on leaves; *Phacídium álneum* Fr., *Perisporium álneum* Fr., *A'nthina dichótoma* Fr."

2530

App. i. *Other Species of A'lnus*. 1690., add:—

"*A. acumináta* Hum. et Bonpl., *Mém. Mus.*, vol. xiv. p. 464. t. 22., and our



2532

fig. 2531., has the leaves ovate, or ovate-oblong, acuminate, roundish at the base, doubly serrated, glabrous above; the veins downy beneath. Panicle naked. Female catkins terminal. (*Mirb.*) A tree, a native of Peru, where it was found by Dombey, and also by Humboldt and Bonpland. Leaves from 3 in. to 6 in. long, and from 1½ in. to 3 in. broad.

"*A. castaneaefolia* Mirb. *Mém. Mus.*, vol. xiv. t. 21., and our *fig.* 2532., has the leaves oblong-elliptic, blunt, repand; or oblong-lanceolate, eroso-dentate petiolate; glabrous above; the axils of the veins downy beneath. Panicle leafy at the base. Male catkins leafy, erect. (*Mirbel.*) A tree, found by Dombey, near Tarma, in Peru. Leaves from 3 in. to 5 in. long, and from 10 to 15 lines broad. Stipules small, glabrous, membranaceous, linear-lanceolate. Male catkins from 1 in. to 2 in. long, more slender than in *A. glutinosa*, and 4 or 5 in a panicle. Female catkins about 2 lines long, 4 or 5 on a common pedicel. (*Mém. Mus.*, xiv. p. 464.)"

Bétula álba. Page 1704., add to the list of fungi: "Besides the species mentioned above, Mr. Berkeley informs us that the following are found upon the birch: — *Agáricus torulosus Pers.*, *A. pulmonarius Fr.*, *A. álgidus Fr.*, *A. ríngens Fr.*, *Dædàlea álbida Fr.*, *D. díscolor Fr.*, *Polýporus chiòneus Fr.*, *P. pubéscens Fr.*; *P. nídulans Fr.*, also on the beech; *P. annòsus Fr.*, *Hýdnum díversídens Fr.*, *H. leonínum Fr.*, *H. corrugátum Fr.*, *H. áureum Fr.*, *H. subcárneum Fr.*, *H. cristulátum Fr.*, *H. argútum Fr.*, *H. subtile Fr.*, *Theléphora sarcóides Fr.*, *T. anthóchroa Fr.*, *T. mùcida Fr.*, *T. cónfluens*, *Peziza Schumácheri Fr.*, *Patellària oliváceo-virens Fr.*, *Bulgària pellúcens Fr.*, *Cenangium pulveráceum Fr.*; *C. urcòlus Fr.*, also on the heath; *C. Bétule Fr.*, *Tremélla élegans Fr.*; *Exídía repánda Fr.*, also on the alder; *Sphæria virgultòrum.*"

B. fruticosa. 1705. l. 23 for "*Schrift.*," read "*Schránk.*"

B. papyracea. 1709. l. 16. from the bottom, for "*Gard. Mag.*, vol. xi. p. 407.," read "*Gard. Mag.*, vol. vi. p. 405."

CORYLACEÆ.

Quercus. 1729., l. 26., for "Part IV. of this work," read "our *Encyclopædia of Arboriculture.*"

Q. sessiliflora. 1736. l. 11., add: "In the *First Annual Report of the Edinburgh Botanical Society*, p. 35., Dr. Graham states that he found three varieties of oaks on the banks of Loch Lomond; and that they are the same as those figured in *Martyr's Flora Rustica*, t. 10, 11, and 12."

l. 39., add, after full stop: "At Woburn Abbey."

1746. l. 21., for "Great part of the Forest of Ardennes," &c., read: "In the district of Warwickshire, called the Forest of Arden, are several woods which consist almost entirely," &c.

1773., add to the paragraph headed "*Ireland.*:" "We have been informed by Sir Robert Bateson, that there is an oak in Belvoir Park, in the county of Down, which is supposed to be above a thousand years old. Its trunk measures 28 ft. in circumference, at 6 ft. from the ground; and its branches cover a space the diameter of which is 70 ft."

1790. l. 1., for "we know tree," read "we know no tree."

1809. l. 14. from the bottom, for "small ones," read "small arms."

1818. l. 23., add: "*Scólytus pygmæus* (see p. 1390.) is said to have destroyed 80,000 young trees in the Bois de Boulogne."

1831., before the paragraph beginning "The other lichens," insert: "*U'snea barbata*, *Ach. Syn.*, 306.; *Lichen barbatus* *Linn.*, *articulatus* *Eng. Bot.*, t. 258. f. 2.; and our *fig.* 2533., is also found on the oak."

1837., add to first paragraph: "In addition to the above, the Rev. M. J. Berkeley has sent us the following list of fungi found on the oak: *Agáricus dásyppus Pers.*; *A. speireus Fr.* also beech; *A. chàma Bosc.*, *A. pinis Fr.*; *A. tessulatus Bulk.*, also on pine; *A. ilícinus Dec.*, on *Q. Fex*:"



Dædalea aërea Fr., *D. sérpens Fr.*, *Polýporus frondosus Fr.*, *P. gigantëus Fr.*, *P. cristatus Fr.*, *P. gravëolens Schwein.*, *P. rutilans Fr.*, *P. cròceus Fr.*, *P. micans Ehr.*, *Hýdnum quércinum Fr.*, *Irpex sinuosus Fr.*, *I. defórmis Fr.*, *Rádulum molare Fr.*, *R. Bótrytis Fr.*, *Theléphora discifórmis Dec.*, *T. cándida Schwein.*, *T. frustulata Fr.*, *Clavária anómala Fr.*, *Calócera glos-sóides Fr.*; *Pezíza calycifórmis Fr.*, on leaves; *P. cinnamómea Dec.*, and *P. purpúrea Fr.*, on stumps; *P. errática Fr.*, *P. ceracélla Fr.*, *P. ferru-ginea Schum.*, *P. olivácea Batsch*, *P. melanophæ'a Fr.*, *P. compréssa A. et S.*; *P. inclúsa Pers.*, also upon sallow; *Ditiola volvata Fr.*, *Cenangium trian-gulare Fr.*, *C. túrgidum Fr.*, *Stictis hystérina Fr.*, *S. álba Fr.*, *Tremélla frondosa Bull. Fr.*, *Agýrium nígricans Fr.*; *Nidulária fárceta Fr.*, also on pine; *Sphæ'ria colliculósa Schwein.*, on *Q. lyrata*; *S. succenturiata Tode*, also upon other trees; *S. atropunctata Schwein.*, on *Q. lyrata*; *S. scabrósa Dec.*, *S. infernalis Kz.*, *S. Micheliána Fr.*; *S. gyrósa Schwein.*, also on beech; *S. Quércuum Schwein.*, on American species; *S. mutábilis Pers.*; *S. canéscens Pers.*, also on beech; *S. ordinata Fr.*, *S. seriata Fr.*, *S. ovóidea Fr.*, *S. móbilis Tode*, *S. latericólla Dec.*, *S. vilis Fr.*, *S. stricta Pers.*; *S. barbata Pers.*, on leaves; *S. myriádea Dec.*, on leaves; *Sphæronéma pyrífóme Fr.*; *Cytispora guttifera Fr.*, also on hazel; *Phacidium calicifóme Fr.*; *Hystérium várium Fr.*; *H. flexuósum Schum.*, also on plum; *H. punctifóme Fr.*, on leaves; *Rhytisma quércinum Rudolphi*, on *Quercus coccéfera*; *Didérma ramósum Fl. Dan.*, *Phýsarum píceum Fr.*; *Arcýria ochroleuca Fr.*, also on beech; *Perichæ'na quercina Fr.*; *Líceá subérea Fr.*, on cork; *Dichospórium aggregátum Nees*, *Érysiphe epixylon Schlecht.*, *A'nthina purpúrea Fr.*, *A. penicillata Fr.*; *Cedémium ramósum Fr.*, also on *Andrómeda arbórea*; *Myx-ótrichum cæsium Fr.*, *Helicospórium végetum Nees*, *H. obscúrum Corda*, *Helminthospórium subulátum Nees*, *H. micrótrichum Corda*; *Dactýlium cándidum Nees*; *Fusídium flávo-virens Ditm.*, and *F. griseum Ditm.*, on leaves; *Psilónia gláica*, also on beech; *P. maculáfórmis Fr.*, also on lime; *Næ-máspora micróspera Dec.*, also on hornbeam; *Stilbóspera rhadóspera Fr.*, *Sporidésmium ciliátum Corda.*"

Page 1837. line 4. from the bottom, after "In Kent," add: "At Knole is a very remarkable tree, which has been called the Old Oak for more than two centuries. Its height is only 42 ft., but its girt, at 4 ft. from the ground, is 28 ft., and the diameter of the space covered by its branches 186 ft."

Q. Cérris. Varieties. 1848., Before "*Q. C. 3 variegata*" introduce:—

"*Q. C. 2 laciniata. fig. 2534.*— There is a fine tree of this very remarkable variety in Hackwood Park, from which specimens have been kindly sent to us by Lady Bolton."



Q. heterophýlla. 1894. Mr. Gordon informs us that there is an oak under this name in the Horticultural Society's Garden, received from Bartram's Botanic Garden; and that he thinks it a variety of *Q. Phéllus*.

Q. Phéllus. 1897. l. 15., add: "*Phalæ'na Polyphémus Abb. and Sm. Ins. of Geor.*, t. 47., and our *fig. 2535.*, the peacock emperor moth, feeds, in the larva state, on this and other kinds of oaks."

Q. Ballóta. 1906. l. 33., after full stop, add: "Mr. Gordon informs us that plants have been raised in the Horticultural Society's Garden, from acorns collected by M. Vilmorin from the true ballota in the Jardin des Plantes; and that they appear to be identical with *Q. gramúntia*, and the *Q. hispánica* of Captain Cook."

Q. virens. 1918., add to "*Synonymes:*" "*Q. hemisphæ'rica* of Bartram's Botanic Garden."

Q. serrata. 1936., add to paragraph. "Plants of this species were brought to

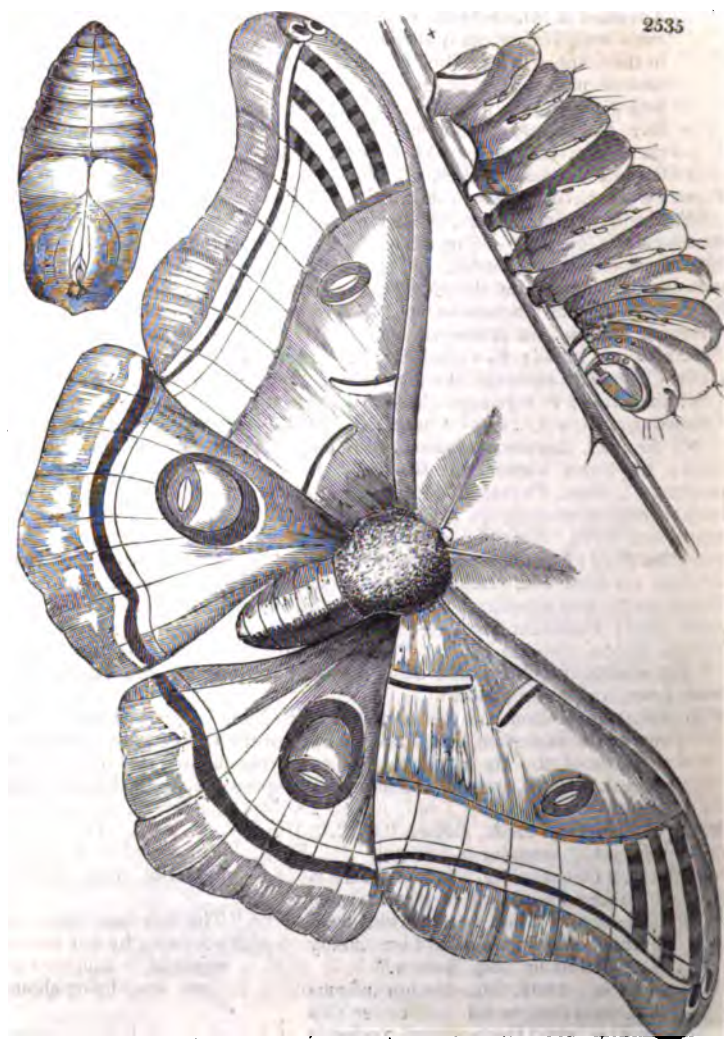

- Kew Gardens, from Leyden, in 1837, having been previously introduced into the Botanical Garden there by Dr. Von Sieboldt."
- Q. glaberrima.* Page 1938., add: "Plants were brought to Europe by Dr. Von Sieboldt, and introduced into Kew Gardens in 1837."
- Mexican Oaks.* 1941. Acorns of *Q. xalapensis* have been received from Xalapa, in Mexico, sent by M. Hartweg to the Horticultural Society's Garden, from which plants have been raised. The acorns are flatter than those shown in fig. 1852.; but the leaves are the same.
- Mr. Low of the Clapton Nursery has received several kinds of acorns of Mexican oaks, but without names, from which plants have been raised, and are now (February, 1836) several inches high. The acorns were all gathered on the mountains in the neighbourhood of Real del Monte; but the trees are found in various parts of the country, at

elevation of from 4000 ft. to near the regions of perpetual snow. The trees are all evergreen in their native country. They have entire leaves in the manner of *Q. Phellos*; but, as the leaves of this species, as we have seen in p. 1895., vary much as the plants grow up, their ultimate forms may be lobate like those of *Q. virens* (see p. 1919.), which, as there shown, are also entire when young. If the reader will look over the figures of Mexican oaks, given between p. 1941. and p. 1949., he will find some species resembling *Q. Phellos*, and some resembling *Q. virens*.

Fagus. Page 1949., after last line, insert:—

“Professor Mirbel, in the *Mémoires du Musée*, makes the following observations on this genus:—‘The introduction into the genus *Fagus* of three or four species which had not been described modifies the generic character, and authorises the division of the group into two distinct sections, as follows:—

“‘*Gen. Char.* Flowers monœcious.—Male, solitary or in aggregate heads. Perianth simple, membranaceous, 1-leaved; stamens 8—40.—Female, twin or ternal, in a 4-partite cupule. Perianth simple, adherent, 6-toothed. Ovary 3-celled, each cell containing 2 ovules. Style 1, short. Stigmas 3, awl-shaped.—Fruit 3-angled, 1-celled, 1-seeded. Seed pendulous. Radicle turned to one side, short. Cotyledons thick, fleshy. Perisperm none.

“‘Sect. I. Cupule muricate, capsuliform. Ovaries included. Young leaves plicate.

“‘*Fagus sylvatica*.

ferruginea.

obliqua.

“‘Sect. II. Cupule involucriform; segments narrow, laciniate. Ovaries laterally exerted. Young leaves not plicate.

“‘*Fagus Dombeyi*.

betuloides.

dubia.’

“Mirbel adds that he cites ‘neither antarctica *Forster*, nor *F. cochinchinensis* *Lour.*, nor the *Fagus* which, according to Cunningham (*King’s Survey of the Coasts of Australia*, i. p. 158.), grows in Van Diemen’s Land. The description of the first is nothing, because the female flower is not yet known. The description of the second is so far from giving an accurate idea of the tree seen by Loureiro, that we may doubt whether or not it is a *Fagus*; and the species of Van Diemen’s Land, mentioned by Cunningham, has neither been described nor named.’ (*Mirb. in Mém. Mus.*, xiv. p. 472.) The *Fagus* mentioned by Cunningham is probably the *F. betuloides*, as that is stated by Backhouse (*Gard. Mag.*, vol. xi. p. 40.; and *Comp. to Bot. Mag.*, vol. ii. p. 40.) to be found wild in Van Diemen’s Land.”

F. sylvatica. 1970. l. 16. from the bottom, insert: “The marriage beech at

Inverary, of which we have been favoured with a drawing by our friend W. A. Nesfield, Esq., from which *fig.* 2536. is engraved, is another example of inoculation; the arm which unites the two trees being about 20 ft. from the ground.

“The beech tree is a non-conductor of lightning; and so notorious is the fact in America, that the Indians, whenever the sky wears the appearance of a thunder-storm, leave their pursuits, and take refuge under the nearest beech tree. In Tennessee, the people consider it a complete protection. Dr. Becton, in a letter to Dr. Mitchell, states that the beech tree is never known to be struck by atmospheric electricity, while other trees are often shivered into splinters. (*American Paper*, as quoted in *Morn. Chron.*, October 21. 1837.)”

1976., insert, after the paragraph headed “*Lichens* :”—

“The following list of additional fungi, found on the beech, has been sent to us by the Rev. M. J. Berkeley:—*Agaricus supinus* Fr.; *A. corticalis* Fr., also on hazel; *A. spodoleticus* Fr., *A. ursinus* Fr., *A. fluxilis* Fr.; *A. nidulans* Pers., also on birch; *A. atrocæruleus* Fr., *A. plenus* Fr., *A. nanus* Pers., *A. hispidulus* Fr., *A. placidus* Fr., *A. Linkii* Fr., *A. reticulatus* Pers., *A. aleuriatus* Fr., *A. ephëbius* Fr., *A. Vahlii*



Schum., *A. byssisèdus Pers.*, *A. nucisèdus Fr.*, *Dædàlea variegàta Fr.*, *D. ferruginea Schum.*, *D. latissima Fr.*, *Polýporus umbellàtus Fr.*, *P. lacteus Fr.*, *P. dichrous Fr.*, *P. subspadiceus Fr.*, *P. nitidus Fr.*, *P. purpureus Fr.*, *P. rhodellus Fr.*, *P. vitreus Fr.*, *P. farinèllus Fr.*; *Hýdnum Ramària Fr.*; *H. cirrhàtum Pers.*, also on oak; *H. fúscò-àtrum Fr.*; *H. diàphanum Schrad.*, also on birch; *H. obtùsum Schrad.*, *H. squalinum Fr.*, *Yrpex lacteus Fr.*, *I. cárneus Fr.*, *Rádulum fagíneum Fr.*, *Theléphora ciliàta Fr.*, *T. punicea A. et S.*, *T. pùbera Fr.*, *Peziza plúmbea Fr.*, *P. gemmàta Schum.*; *P. capillàris Fr.*, on leaves; *P. fuscéscens Pers.*, *P. melaxántha Fr.*, *P. crucibulum Batsch*, *P. lenticulàris Bull.*, *P. lùteo-virens Fr.*, *P. discifórmis Fr.*; *P. fagínea Pers.* on mast; *Ditiola paradóxa Fr.*, *Solènia cándida Fr.*; *Scleròtium pezizàforme Schum.*, on leaves; *S. truncórum Tode*, *Periòla hirsùta Fr.*, *Polyangium umbrínium Fr.*, *Sphæria polymórpha Pers.*; *S. carpóphila Pers.*, on mast; *S. cornifórmis Fr.*, *S. cohærens Pers.*, *S. lactea Fr.*, *S. atropurpurea Fr.*; *S. lénta Tode*, also on willow; *S. pilulifera Fr.*, *S. conspurcàta Kz.*; *S. sphinetrina Fr.*, also on crab; *S. theléna Fr.*; *S. crinita Pers.*, also on hazel; *S. umbonàta Fr.*; *S. rostràta Fr.*, also on birch; *S. hiáscens Fr.*, *S. Depàzes fagícola Fr.*; *Sphæronèma cónicum Fr.*, also on fir; *S. hemisphæricum Fr.*, also on pine; *S. colliculòsum Fr.*, *Hystèrium acuminàtum Fr.*, *H. túmidum Fr.*, *Reticulària plúmbea Fr.*, *Didérma lepidòtum Fr.*, *Didýmium marginàtum Fr.*, *D. furfuràceum Fr.*, *Phýsarum psittacínium Ditm.*, *P. bullàtum Lk.*, *P. connàtum Schum.*, *P. utriculàre Fr.*, *P. paniceum Fr.*, *P. thejóteum Fr.*, on the leaves; *P. viréscens Ditm.*, *Stemonitis mammòsa Fr.*, *Trichia rubifórmis Pers.*, *T. clavàta Pers.*, *T. nigripes Pers.*, *Liccia bàdia Fr.*, *Onygena*

fagínea Fr., *Trichodérma rùbrum Pers.*, *Perispòrium fagíneum Fr.*, *Isària clavàta Ditm.*, *I. glàuca Ditm.*, *A'nthina flàvo-virens Fr.*, *A. filàris Fr.*, *Scòrias spongiosa Fr.*, *Stilbum lùteum A. et S.*, *S. turbinàtum Tode.*, *S. gelatìndum Pers.*, *Hydròphora mínima Fr.*, *Sporòcybe caliciòides Fr.*, *Cedèmium àtrum Fr.*, *Helminthospòrium cylíndricum Corda*; *Bòtrytis Fumàgo Fr.*, leaves; *Pailònia nívea Fr.*; *Melanconìum Papulària Fr.*, leaves "

Page 1977, line 5, from the bottom, insert: "In Surrey, at Deepdene, is a beech tree 85 ft. high; trunk 31 ft. in circumference at 1 ft. from the ground; spread of the head 219 ft."

1978. l. 27., insert: "In Kent, at Knole, is a beech 89 ft. high; girth of the trunk 25 ft., and diameter of the head 352 ft."

Castànea. 1999., end of the paragraph of "*Accidents and Diseases,*" add: "The Rev. M. J. Berkeley has sent us the following list of the fungi of this genus:—*Peziza echinòphila Bull.*, which is found upon the rotting involucre of the chestnut on the Continent; *Fistulìna radicàta Schwein.*, *Sphæria Castànæ Schwein.*; *S. Depàzea castànæcola Fr.*, on the leaves (this is properly an abortive state of *Phacidium dentatum*); *Hystèrium Castànæ Schwein.*; *Cratèrium globòsum Fr.*, husks; *Dic-tydium didermòides Fr.*, leaves; *Demàtium Castànæ Schwein.*, *Sporòtrichum cæsièllum Fr.*"

Cárpinus. 2008. l. 14. from the bottom, add to the paragraph: "*Fig. 2538.* p. 2596. will give an idea of a labyrinth planted with hornbeam hedges, similar to that still existing at Hampton Court. The object in planting a labyrinth is to form a puzzle, first to discover the centre, and afterwards to find the way out again. For this purpose the hedges should be sufficiently thick not to be seen through, and sufficiently high not to be seen over; and in order that the surface of the ground may be dry, the whole ought to be thoroughly drained before planting. The hornbeam is preferred for labyrinths, on account of its rapid growth, and because it retains its leaves throughout the winter. The building in the centre may be a summer house, and the labyrinth may be rendered more intricate by introducing stop-hedges across the path, at different places, as indicated in the figure by dotted lines."

Accidents and Diseases. 2012., three lines from the end of the paragraph, for "have been observed" to the end, substitute "are also found on the hornbeam: as are, *Merùlius rufus Pers.*, also on beech; *Rádulum lætum Fr.*, also on beech; *Peziza cárnea Fr.*, also on beech; *Stictis Bétuli Fr.*, *Sphæria argillàcea Fr.*, *S. gástrina Fr.*; *S. cuspidàta Fr.*, also on beech; *S. amcèna Nees*, also on hazel; *S. Depàzea carpinicola Schwein.*, on the leaves; *Actinoclàdium rhodòsporum Ehr.*, *Oídium virèscens Lk.*, *Urèdo Cárpini Desm.*"

Ostrya virgínica. 2016., add to list of *Engravings*: "and *fig. 2537.*"

Córylus Avellàna. Varieties. 2017., add to "*C. A. 4 purpùrea:*" "When grafted on a common hazel, it imparts its colour to the leaves of the stock."

2024. l. 9., after full stop, add: "Hazel nuts are grown in such quantities in the cultivated region of Mount Etna (which extends to 3300 ft. above the level of the sea), that they form a considerable article of export from Sicily, especially to England. (*Comp. to the Bot. Mag.*, vol. i. p. 50.)"

Fungi on the Hazel. 2028. Add to the end of the paragraph: "The following additional list has been sent to us by Mr. Berkeley:—*Agáricus eùchrous*





Pers., also on alder; *Peziza fissa Fr.*, *P. bolàris Batsch*; *P. vulgàris Fr.*, also on bramble; *Phallus caninus Huds.*, *Sphaeria unita Fr.*, *S. versàtilis Fr.*, *S. leucopis Fr.*, *S. tessera Fr.*, *S. conjuncta Nees*, *S. umbilicàta Pers.*; *S. conglobàta Fr.*, also on birch; *S. subusta Fr.*, *S. Còryli Batsch*, and *S. cilicifera Fr.*, on the leaves; *A'nthina fùlvi Fr.*"

C. rostràta. Page 2030., add, after "Boston:" "The nuts are so hard, that they are said to have been used by the inhabitants as shot."

PLATANACEÆ.

Platanus. Page 2042. insert, before "Statistics:"—

"The only fungi found on plants of this genus are: *Sphæria medusina* Fr., and *S. pupula* Fr.; the latter being found, also, on the maple."

BALSAMACEÆ.

Liquidambar *Styraciflua*. 2052., add to the paragraph headed "Accidents, Diseases, &c.:" "The following list of fungi has been sent to us by the Rev. M. J. Berkeley:—*Thelëphora Styraciflua* Schwein.; *Peziza flàmmea* A. et S., also on apple and hornbeam; *Stictis farinosa* Fr.; *Sphæria carpophila* Pers., also on beech mast; *S. perforata* Schwein., *S. Liquidambaris* Schwein., *S. petiolorum* Schwein."

MYRICACEÆ.

Myrica Gåle. 2057., add to first paragraph: "*Peziza ciliaris* Schrad. is found on this species."

GNETACEE.

E'phedra americana. 2065., add to list of Engravings: "and fig. 2539."

TAXACEÆ.

Taxus baccata. 2074. l. 9. from the bottom, for "short equal but," read "short squat but."

2091., add to paragraph entitled "Accidents, Diseases, &c.:" "The following additional list of fungi has been sent to us by the Rev. M. J. Berkeley:—*Thelëphora Chaillëti* Fr., *T. areolata* Fr., *T. sanguinea* Fr., *T. odorata* Fr., *Sphæria dispar* Fr., *Phacidium Taxii* Fr."

Phyllócladis trichomanóides. 2102., after the name, dele "R. Br., and."

CONFERÆ, Sect. ABIE'TINÆ.

2106., add, before Sect. I.:—

"Professor Link, in a very able article *On the Genus Pinus, and its European Species*, proposes to separate the genera *Dámmara*, *Cunninghãmia*, and *Araucãria* from the *Abiëtinæ*, not only on account of the breadth and expansion of their leaves, but from their containing spiral vessels sufficiently large to be easily perceptible in the leaves produced on the old wood, (whereas, in the genera *Pinus* and *Abies*, the spiral vessels are very small, and, indeed, only perceptible in the young shoots,) and from the inverted position of the female blossoms. This new family he proposes to call *Dámmaracææ*."

Pinus. 2152., add to "Description:" "Professor Link agrees with Mirbel and Schubert (part xv. *Annales du Mus.*, and part iii. *Bull. de la Soc. Phil.*) in considering the genus *Pinus* to belong to *Monocëcia Monándria*, instead of *Monocëcia Monadélphia*, where it was placed by Linnæus; and he instances *Pinus Tæda* as affording a convincing proof of the correctness of this classification."

P. sylvéstris. 2170. l. 11., for "James," read "John."

l. 1. from the bottom, for "builder," read "timber merchant."

2183. l. 14. from the bottom, for "wood," read "road."



Page 2184. Before "Statistics," insert :—

"Fungi. We have received the following list from the Rev. M. J. Berkeley, who remarks that the species given here as belonging to *Pinus*, and also those stated to belong to *Abies* (see p. 2601.) and to *Picea* (see p. 2602.) are not exclusively confined to these genera. It is probable that a great number occur indifferently on all pines and firs.—*Agáricus trichæus Pers.*, *A. decòrus Fr.*, *A. marginèllus Pers.*, *A. lacteus Pers.*, *A. chrysophyllus Fr.*, *A. sapineus Fr.*, *A. pícreus, Pers.*, *A. flammans Batsch*, *A. astragálinus Fr.*; *A. átro-tomentòsus Batsch*, also on willow; *A. proboscídeus Fr.*, *Mèrùlius fúgax Fr.*, *M. vastàtor Tode*, *M. mollúscus Fr.*, *M. himantiòides Fr.*, *M. porinòides Fr.*, *M. squálidus Fr.*, *Dædàlea Pini Fr.*, *D. heteromórpha Fr.*, *Polýporus gallicus Fr.*, *P. pes capræ Fr.*, *P. destrúctor Fr.*, *P. stýpticus Fr.*, *P. móllis Fr.*, *P. tephroleúcus Fr.*; *P. alutáceus Fr.*, also on beech; *P. pinícola Fr.*, *P. bombýcinus Fr.*; *P. saniòsus Fr.*, also on fir; *P. mùcidus Fr.*, *P. reticulátus Nees*, *Hýdnum mácrodon Pers.*, *H. Pinástri Fr.*, *H. alutáceum Fr.*, *H. fasciculàre A. et S.*, *Irpex paleáceus Fr.*, *I. fusco-violáceus Fr.*, *Theléphora crispa Pers.*, *T. bicolor Schrad.*, *T. Pini Schlecht.*, *T. reticulàta Fr.*, *T. olivácea Fr.*, *T. violáscens Fr.*, *T. papillòsa Fr.*, *T. cálcea Pers.*, *T. móllis Fr.*, *T. ochrácea Fr.*, *T. granulòsa Pers.*, *T. seriális Fr.*, *T. lívida Fr.*, *Clavária pyxidàta Pers.*, *C. virgàta Fr.*, *Helvélla infúla Schæff.*; *Peziza tuberòsa Bull. b.*, on cones; *P. rubricòsa Fr.*, amongst leaves; *P. byssisèda Fr.*, *P. pinícola Rebenl.*, *P. tenèrrima Fr.*, *P. chionèa Fr.*, *P. abécina Fr.*, *P. chrysòcoma Bull.*, *P. áurea Fr.*, *Patellària púlla Fr.*, *Ascòbolus lignátillis A. et S.*, *A. denudátus Fr.*, *Stictis hemisphærica Fr.*; *Solènia fasciculàta Pers.*, also on birch; *Exídia pithya Fr.*, *Dacrýmyces fragifórmis Fr.*, *D. tórtus Fr.*, *Páchyma Cocos Fr.*, *Pyrenium lignátile Fr.*, *Scleròtium strobilinum Schum.*, *S. immèrsum Fr.*; *S. floccipéndulum Fr.*, on leaves; *S. emérgens Fr.*, *Thelèbolus súdans Fr.*, *Sphæria lobàta Wormsk.*, *S. lineàta A. et S.*; *S. colliculus Wormsk.*, on *P. pygmæa*; *S. Pini A. et S.*, *S. clópima Fr.*, *S. decumbens Schm.*, *S. pithyóphila Schm.*, *S. chionèa Fr.*, *S. vermiculària Nees*, *S. picàstra Fr.*, *S. stílbum Schm.*, *S. pulverulénta Fr.*, *S. operculàta A. et S.*, *S. socià Nees*, *Lophium mytilinèllum Fr.*, *L. aggregátum Fr.*, *Sphæronèma rufum Fr.*; *S. aciculàre Fr.*, also oak; *S. truncátum Fr.*, also on fir; *Cytispora Pinástri Fr.*, on leaves; *Dothidea Pinástri Fr.*, *Phacídium pithyum Fr.*, *P. pulveruléntum Schm.*, *P. lácerum Fr.*, *Hystèrium gráphicum Fr.*, *Lycógala plúmbeum Fr.*, *Reticulària versicòlor Fr.*; *Didérma vaiátum Fr.*, also on alder; *Didýmium rùpès Fr.*, also on fir; *Physarum Pini Fr.*, *P. Lícea Fr.*, *P. nigrum Fr.*, *Stemonitis ferrugínea Ehrenb.*, *S. oblóngà Fr.*, *S. papillàta Pers.*, *Dictýdium spléndens Schrad.*, *D. micropus Fr.*, *Perichæna contòrta Fr.*, *Lícea flexuòsa Pers.*, *L. mínima Fr.*, *Coniòsporium oliváceum*, on boards of *Pinus marítima*; *C. nigrum*, *Isària moniliòides A. et S.*, *Cerátium áureum Lk.*, *Stílbum byssisèdum Pers.*; *S. pùbidum Tode*, on leaves; *S. pilifórmè Pers.*, *Myxòtrichum ràrum Fr.*, *M. pátulum Fr.*, *Sporòtrichum turbinátum Fr.*, *S. viréscens Lk.*, *S. vitèllinum Lk.*, *Tórula rùdis Fr.*"

2185. l. 36., for "Stretton Parsonage," read "Stutton Rectory."

l. 43., add to paragraph : "At Thirkleby, it is 11 ft. 6 in. in circumference, at 3 ft. from the ground."

P. pumilio. 2186., to the list of *Synonymes*, add : "*P. humilis Link* in *Berl. Abhand.*, 1827, p. 172."

P. p. Mughus. 2187., add to "*Synonymes*:" "*P. pumilio Link*, l. c."

2188. l. 23., for "*P. a. uncinàta*" read "*P. uncinàta*."

2189., add to "*Other Varieties*:" "Professor Link mentions *P. rotundàta*, which, from the description he gives of it, appears to be the same as the *P. uncinàta* of Captain Cook. (See p. 2188.; and Cook's *Sketches in Spain*, ii. p. 230.)"

P. Lucio. 2200., add to "*Identification*:" "Link in *Berl. Abhand.*, p. 174."

P. austriaca. 2205., add to "*Synonymes*:" "*P. nigra Link Berl. Abhand.*, p. 173." Under the wood-cut, for "2005," read "2065."

P. Pináster 2213., add to "*Identification*:" "Link in *Berl. Abhand.*, 1827, p. 175."

P. P. Lemoniàna. Page 2215. line 12., for "2101.," read "2103. in p. 2216."
P. halepensis. 2231. Professor Link, speaking of this species, says that Lambert has given a good figure of it; but that he is wrong in stating that the cones are single, as they are never less than two or three together on wild trees. (*Berl. Abhand.*, p. 177.)

P. h. maritima. This pine, which Link calls *P. maritima*, has, he states, the cones on long footstalks, bent downwards, and in clusters of at least two or three together. (*Ibid.*, p. 177.)

P. brutia. Page 2234. Professor Link describes this species as forming a tree as lofty as *P. Laricio*. The cones, he adds, are not sessile, but on very short footstalks, a little bent downwards. The wing of the seed is from 6 to 8 lines long, sword-shaped, narrow at the base, but widening gradually towards the summit. It is a very handsome tree, and is easily distinguished by its very long slender leaves, and nearly smooth cones; the points of the scales being very much pressed in. (*Ibid.*, p. 176.)

P. variabilis. 2243. l. 45. After "The buds in Mr. Lambert's figure appear to be resinous," add: "and are nearly smooth (see fig. 2540.);" "but," &c.

P. Llaveana. 2267., for "Otto," read "*Schiede et Deppe*," as the authority for the name. In the list of *Engravings*, for "our figs. 2180. and 2181.," read "our figs. 2177. to 2179.;" and add, after full stop: "The cone, seed, and scale are from specimens kindly sent to us by M. Otto of Berlin."

Abies. 2293. Professor Link, in 1827, divided the species which compose this genus, from *Pinus* under the name of *Picea*, the Latin for the spruce fir, as *Abies* is for the silver fir; the mistake of the older botanists, which was followed by Linnæus, in reversing these names, having led to great confusion.

"This genus," Professor Link observes, "approaches the nearest to that of *Pinus*, and, upon close inspection, still more so than at the first glance. For instance, if the leaves that stand singly are examined minutely, it will be seen that several of them have their surfaces (oberflächen) grown together; and, consequently, they are in tufts, like the leaves of the pine. As a proof that this is the case, it will be found that there is no upper surface on the leaves of the fir; but that the leaves present only the under surface on both sides, as will be seen on comparing them with the leaves of the pine. The seam (fuge) where the leaves are joined may be distinctly seen: it forms a line in relief on both sides of the leaves of the common spruce; which is never the case when such a line is formed by the midrib, because it is then either on the upper or under side. Some firs have two leaves grown together, others four. The sheaths at the base of the leaves are not observable, but they appear to have grown together in the short foot-stalk."

A. excelsa. 2293., add to "*Synonymes*:" "*Picea vulgaris* Link in *Berl. Abhand.*, p. 180."

2295., add to the paragraph headed "*Other Varieties*:" "*Pinus viminalis Alstram.*, the Hångetanne of Sweden, with long, slender, pendulous, leafless twigs, is a kind frequently found in spruce fir woods; but Link considers it only a variety of the common spruce. (*Berl. Abhand.*, p. 182.) The Earl of Aberdeen mentions a spruce at Harewood House, Yorkshire, resembling very much the *A. e. tenuifolia*, or *A. e. elegans*, in leaves and shoots. 'The tree,' His Lordship observes, 'is of a peculiar habit and character. It is about 40 ft. high; the branches are all slender, and point upwards, giving the tree a



2540

compact and conical appearance. The branches grow each from a sort of protuberance on the main trunk of the tree; especially the larger and lower branches. I have never observed cones. Nothing is known of the history of the tree; but, from its position, it is probable that it was planted at the same time as those in its neighbourhood, several of which are common spruce and silver fir, and are of much greater size: perhaps 70 ft. or 80 ft. high.'

"The specimens sent to us by His Lordship were considered by Mr. Frost and Mr. Gordon, who have attended in a particular manner to the *Abiétinæ*, to belong to *A. álba*, or *A. nígra*, rather than to the common spruce. We have subsequently received specimens from Harewood House, which we have distributed among the nurserymen, under the name of *A. e. strícta*. The gardener at Harewood has never observed any cones on the tree; which induces us to consider it as a kind of monstrosity, like the last variety mentioned, and *A. e. Clán-brasiliana*; the species being prone to produce extraordinary varieties of this kind."

Page 2310. Before "*Statistics*," introduce:—

"*Diseases, Fungi, &c.* In the *Magazine of Natural History* is a commu-

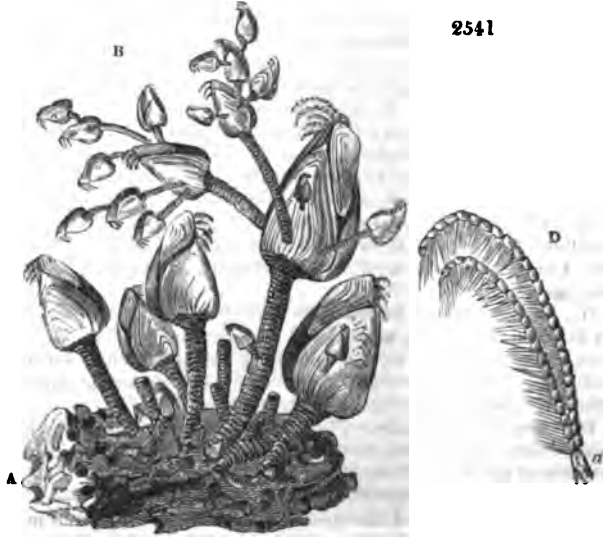

2541

nication from the Rev. W. B. Clarke, A.M., from which it appears that the barnacles (*Lepas anatifera*) are found on the wood of the spruce fir, as well as on that of the oak. In February, 1834, part of the branch of a spruce fir, with the bark on, was picked up in Poole Harbour, completely covered with barnacles. In fig. 2541., A shows a portion of this wood, much perforated with the *Terèdo*; B, the *Lepas*, with young individuals growing upon the older. C shows the animal exposed by the removal of the upper lower valve; a, the under lower valve; b, the body of lobes, that of each supporting a pair of ciliated tentacula or feet; c, the double interior tubes. D shows a single pair of ciliated feet, magnified; e, one of the two strong joints below the bifurcation. The fir branch is supposed to have been two or three



years in the water, as the wood was become soft and pulpy; and it had evidently been perforated by the *Terèdo* (as some shells of these creatures were found in the thickest part of the branch), before the barnacles took possession of it. Barnacles are also found attached to other kinds of wood, particularly to logs of mahogany, which from any accident have become adrift. The *fungi* on the *A'bies* are: *Agáricus adhærens A. et S.*, *A. pristoides Fr.*; *A. splachnoides Horne*, and *A. pérforans Hoffm.*, on the leaves; *A. Albertini Fr.*, *A. aceròsus Fr.*, *Merùlius umbrinus Fr.*, *Polýporus boreális Fr.*, *P. fragilis Fr.*, *P. seriális Fr.*, *P. stereoides Fr.*, *P. benzòmus Wahl.*, *P. odorátus Fr.*, *P. róseus Fr.*, *P. unitus Pers.*, *P. violáceus Fr.*, *Hýdnum gelatinòsum Scop.*; *H. corallòides Scop.*, also on beech; *H. minútum Schum.*, *H. bicolor A. et S.*, *H. Agárdhii Fr.*, *Írpex spatulátus Fr.*, *Theléphora conchàta Fr.*, *T. abiétina Pers.*, *T. umbrina A. et S.*, *T. stérilis Fr.*, *Clavària apiculàta Fr.*, *Calócera furcata Fr.*, *Peziza ollàris Fr.*, *P. sulfuràta Fr.*, *P. pygmæa Fr.*, *P. cærùlea Bolt.*, *P. pilòsa Schum.*, *P. ácuum Fr.*, *P. porioides A. et S.*, *P. lutescens A. et S.*; *P. versifórmis Pers.*, and *P. configna Pers.*, and *b.*, on cones; *P. resinæ Fr.*, *P. lignyòta Fr.*, *Sàrea diffórmis Fr.*, *Bulgària nigrita Fr.*, *Cenangium ferruginòsum Fr.*, *Stictis chrysophæa Fr.*, *Exidia sacchàrina Fr.*, *Scleròtium cárneum Fr.*, *Sphæria Kúnzei Fr.*, *S. de órmis Fr.*; *S. strigòsa Fr.*, also on pine; *S. resinæ Fr.*; *S. sapínea Fr.*, also, but smaller, on the pine; *Strígula abiétina Fr.*, *Phacidium Pinástri Fr.*, *P. abiétinum Schm.*, *Hystèrium elátinum Pers.*, *Actidium hysterioides Fr.*, *Didérma stellàre Schrad.*, *D. minútum Fl. Dan.*, *Didýmium tigrinum Schrad.*, *Phýsarum fúlvum Fr.*, *Stemonitis pumíla Fr.*, *S. physaroides A. et S.*, *Dic-týdium ambíguum Schrad.*, *D. microcárpum Schrad.*, *D. venòsum Schrad.*, *Cribrària macrocárpa Schrad.*, *C. fúlva Schrad.*, *C. pyriformis Fr.*; *C. argillàcea Pers.*, also on pine; *C. rubiginòsa Pers.*, *C. purpurea Fr.*, *C. intricàta Fr.*, *C. aurantiaca Fr.*, *C. tenélla Fr.*, *Arcýria nútans Fr.*, *A. umbrina Schum.*, *Trichia serótina Schrad.*; *Perichæna strobilina Fr.*, also on pine; *P. incarnàta Fr.*, *Lícea cylíndrica Fr.*, *L. fragifórmis Fr.*, *L. variàbilis Schrad.*, *Chætòmium pusillum Fr.*, *Apiospòrium Abietis Ks.*, *Isària cálva Fr.*, *A'nthina canofúscà Fr.*, *Ceràtium porioides A. et S.*, *Stilbum amaráginum A. et S.*, *Sporocybe resinæ Fr.*

Page 2310. line 42., insert, before "In Stirlingshire:" "At Dupplin Castle it is 107 ft. high, with a trunk 3 ft. in diameter."

A'bies Smithiana. 2318. l. 12., for "diameter," read "circumference."

A. cephalónica. 2325. Throughout the whole of this article, for "General Napier," read "Major-General C. J. Napier."

2328. l. 18., after "Lady Bunbury," add: "who was then residing in Devonshire with another brother, Major-General G. T. Napier, now Governor of the Cape of Good Hope."

Picea. 2329., after the paragraph headed "Description," add:—

"Remarks. In addition to the specific differences already given in p. 2105., Professor Link (who calls this genus *A'bies*) points out the following differences in the leaves, between it and the spruce fir:—'The leaves do not grow together, but are single, and have the usual form of single leaves; the midrib being only visible on the under side, and the upper side having a furrow down the centre of the leaf. They are flat, and in two or more rows. In many species, they are divided at the point. They are also of a very dark green above, and have generally two strips of white on the under side, one on each side of the midrib, which is not the case with the spruce.' (*Abhand.*, &c., p. 181.)

"The Highland Society, in their list of premiums for 1838, offer a medal for the best account of the disease which has of late years attacked the stem, larger branches, and occasionally the twigs, of the silver fir, somewhat resembling the well-known rot of the larch; with suggestions founded on experience, for checking the progress of the malady, or for preventing it. We had not before heard of this disease."

Picea pectinàta. 2332. l. 24. from the bottom, add: "At Studley Park is a

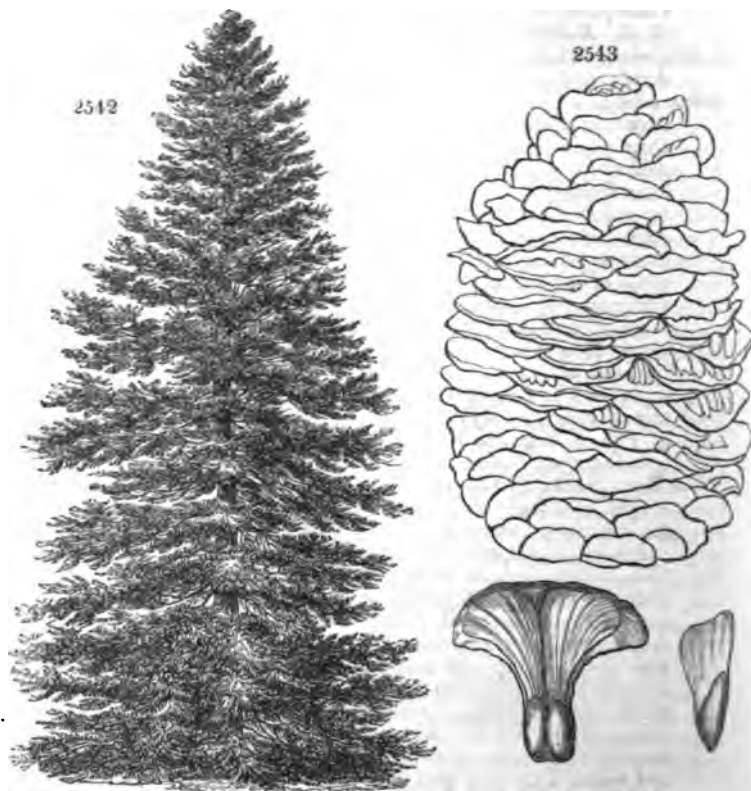

beautiful tree (fig. 2542.), 96 ft. high; diameter of the trunk 3 ft. 6 in., and of the head 50 ft."

- Page 2333, add to the paragraph headed "Geography:" "Professor Link observes that this species never essentially constitutes a whole forest, but is always found mixed with the spruce fir, and other species of *Abiétinæ*. (*Ibid.*, p. 182.)"
2337. Add to "Accidents, Diseases, &c.:" "The fungi found on this species are: *Hydnum Hóllii* Schmidt, *Theléphora Mougeotii* Fr., *Peziza Piceæ* Pers., *P. pithya* Pers., *P. elatina*, *Cenangium chloréllum* Fr., *Cypélla digitalis* Fr., *Sphæronéma acrospérmum* Fr., *Hystérium nervisequium* Dec., *Antennária pinóphila* Nees.— M. J. B."
- Picea religiosa*. 2349., add to "Engravings:" "and our fig. 2543., from the drawing, of the natural size, of a cone of this species in the Berlin herbarium, kindly forwarded to us by M. Otto."
- Láris europæa*. 2387., add to the paragraph headed "Canker:" "We have been confirmed in this conjecture by the editor of the *Quarterly Journal*, Henry Stephens, Esq., who informs us that this disease is named from the rising of the bark like a blister, followed by a copious discharge from it of the resinous sap of the tree; the whole tree afterwards becoming short and dry, like a cork. Mr. Stephens also mentions the disease described in p. 2387., by Mr. Munro, as resembling the canker in apple trees, and says it 'appears like an ichorous discharge around the setting on of the lower branches, in

consequence of which the branches snap short off the trunk.'—
H. S. Redbrae Cottage, Edinburgh, March 2, 1838."

- L. *americana*. *Varieties*. Pages 2400. and 2401., substitute the sign of a deciduous tree for that of an evergreen one, for all the varieties.

Cèdrus Libani. 2413. l. 14. from the bottom, after the words "the old cedar in front of Quenby Hall," add: "see our *fig. 2544.*" Add to the end of the paragraph: "In a letter from Evelyn to Pepys, when the latter was at Tangier, is the following passage: 'Mr. Sheeres will remember the poor gardener, if he happen on any kernels or seeds of such trees and plants, especially evergreens, as grow about those precincts.



2544

Were it not possible to discover whether any of those citrine trees are yet to be found, that of old grew about the foote of Mount Atlas, not far from Tingis? Now, for that some copies in Pliny reade cedria, others citria, 'twould be enquired what sort of cedar (if any) grows about that mountaine.' (*Mem. and Corr. of Pepys*, v. p. 105.) It is remarkable that the cedar has since been found on Mount Atlas."

- C. *Deodàra*. 2431., add to the first paragraph: "In the very interesting review of Moorcroft's *Travels in Ladakh, Kashmir, Bokhara, &c.*, in the *Quarterly Review* for January, 1838, an account is given of the excursion of Captain Johnstone, in August, 1827, to penetrate the Himalaya to the sources of the Jumna, and thence to the confines of Chinese Tartary. They traced the course of the river up to Jumnotree. Cursola, a small village in the very heart of the chasm, is described as an isolated cluster of about 25 houses, 9000 ft. above the sea, with three or four small temples, having excellent roofs of carved deodar wood. The glen from this village to Jumnotree was gloomy, and the peaks were completely hidden by forests of the gigantic deodar. The Brooang Pass was only accessible over a bed of snow; and, on their descent from it on the northern side, they measured a deodar cedar, and found it 33 ft. in circumference, and from 60 ft. to 70 ft. high, without a branch. (*Quart. Rev.*, vol. lxi. No. 121. p. 105.) On the mountains that enclose the valleys of Kashmir, Moorcroft tells us, are immense forests of deodars; the timber of which is extensively used in their temples, mosques, and buildings in general. Such, says Moorcroft, is its durability, that in none of the 384 columns of the great mosque of Jana Musjid was there any vestige of decay, either from exposure or insects, although they had been erected above a century and a half. Most of the bridges are of this timber; and some pieces in one were found very little decayed, though they had been exposed to the action of the water for 400 years. (*Ibid.*, p. 118.)"

Araucària excèlsa. 2443. l. 6., add, after full stop: "A tree at Laxenburg, near Vienna, Baron Jacquin informs us, is one of the finest and most picturesque specimens of this species that can be seen."

l. 7., for "*Araucària imbricàta*," read "*Araucària excèlsa*."

- A. *Cunninghamii*. 2443., add to list of *Engravings*: "Our *fig. 2545.* shows the female cone, and a sprig bearing male cones, to our usual scale; and a young male cone, the point of a shoot, and the leaves on an old branch, of the natural size."

Dámbara austràlis. 2449. l. 54., for "In 1837," read "In December, 1837."

l. 56., after "a pale green tinge," add: "In the *London and Edinburgh Philosophical Magazine* for March, 1838, p. 249., is an article on 'the Kouri, or Cowdee, Resin, by J. Prideaux, Member of the Plymouth Institution.' In this, it is stated that some cargoes of kouri timber

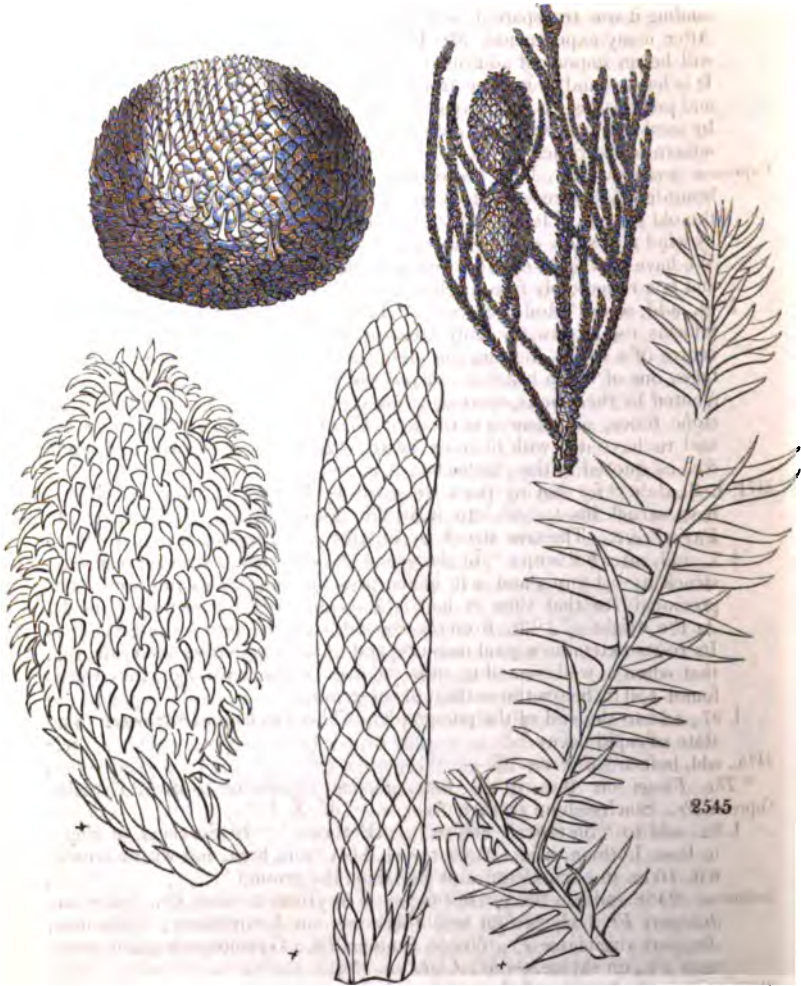

had arrived at Plymouth, for the use of the dockyard there, which were found fully to sustain the high reputation the wood had previously attained. Mr. Yate, in his *Account of New Zealand, &c.*, describes the tree as affording trunks from 85 ft. to 95 ft. long without a branch, and sometimes 12 ft. in diameter; yielding a log of heart timber 11 ft. in diameter. One which he measured, and which was perfectly sound, was 40 ft. 11 in. in circumference. The wood has the appearance of deal, works well under the plane, and smells strongly of resin. The general appearance of the tree in its native forests is most remarkable; the small size and great number of its leaves giving it somewhat the appearance of a box tree. The resin, which is too hard to be scratched by the nail, was found by Mr. Prideaux to be very inflammable, and to burn away with a clear bright flame, but not to drop. On attempting to melt it, it was found to froth and swell, giving out water and aromatic oil, and becoming transparent, but not liquid. After

cooling it was transparent, and nearly as tough and hard as shell lac. After many experiments, Mr. Prideaux considers that the kouri resin will be an important addition to our materials for alcoholic varnishes. It is harder and more free from colour than mastic, quite as soluble, and perhaps less than one tenth of the price. He also thinks it may be used as a gas-light. It was tried as sealing-wax, but found not to adhere to the paper. (*Ibid.*, p. 254.)"

- Cupressus sempervirens*. Page 2466. line 32., add: "There is also a very beautiful old cypress at Stockton House, in Wiltshire, the only relic of the old garden. It is not very tall, as the leading shoot was broken by wind and snow many years ago; and it terminates in several spires. We have no means of ascertaining its age; but it is evidently very old, and is a remarkably fine specimen. — S."
- l. 44., add, after "Mount Sion:" "A tall cypress, an American traveller informs us, is now the only tree on Mount Sinai. It stands in the centre of a valley, high up the mountain, surrounded by other mountains, one of which bears the sacred name of Horeb. The cypress was planted by the monks, more than 100 years ago: it is surrounded by a stone fence, and near it is the fountain of Elias, which the prophet is said to have dug with his own hands. (*Incidents of Travel in Egypt, &c.*, as quoted in the *Athenæum*, Aug. 26.)"
2471. l. 3., dele "for having been wounded by Francis I., who is said to have struck his sword into it, in his despair at losing the battle of Pavia," &c. The tree struck by Francis was a poplar; see p. 2589.
- l. 7., add, after full stop: "In the year 1810, this remarkable cypress was struck by lightning, and left in its present shattered condition; but previously to that time it had a handsome well-proportioned head. At the height of 19 ft. from the ground it divides into six large limbs. Its roots extend to a great distance, and to such an extraordinary depth, that when a well was dug near the tree some years ago, they were found 150 ft. below the surface of the ground."
- l. 27., add to the end of the paragraph: "These trees, in 1836, were in a state of rapid decay."
- 2475., add, before "*Statistics*:" —
 "The Fungi on the cypress are: *Peziza cupressina* Batsch, *Cypella Cupressi* Fr., *Stachyliidium scæptrum* Corda. — M. J. B."
- l. 32., add to "*Statistics*," before "In France:" "In Scotland, at Biel, in East Lothian, it is 120 years old, 41 ft. 2 in. high, and with a trunk 6 ft. 10 in. in circumference at 2 ft. from the ground."
- Juniperus*. 2488., add to the list of fungi: "*Agfrium cæsium* Fr., *Sphæria Juniperi* Fr.; *Hystèrium tórtile* Schwein., on *J. virginiana*; *Podisòma Juniperi virginianæ* Fr., *Urèdo Juniperi* Lk.; *Gymnosporangium sabinum* Fr., on savine. — M. J. B."
- 2505., add, at the bottom of the page: —
 "J. *hemispha'rica* Presl grows above the boundary line of trees on Mount Etna, as high as 7100 ft.; as does *Berberis etnensis* Presl. (*Comp. to Bot. Mag.*, i. 92.)"
- Agave americana*. 2529., add to the paragraph as follows: — "In the year 1837, a plant of this species of *Agave* flowered at Clowance, in Cornwall, the seat of Sir John St. Aubyn, Bart., of which the following account has been sent to us by the gardener, Mr. T. Symons: — 'This plant, of which fig. 2546. is a portrait to a scale of 1 ft. to 4 in., by Mr. Rutger, jun., is 23 ft. high. Mr. Rutger, sen., my predecessor, informs me that, when he came to Clowance, in the year 1800, he found the plant in a small tub; and that about the year 1806 he turned it out, and planted it in the flower-garden, on the site where its remains still stand. For many years, it was nearly stationary, making but little progress in point of size; which may be accounted for by no particular attention having been paid to the preparation

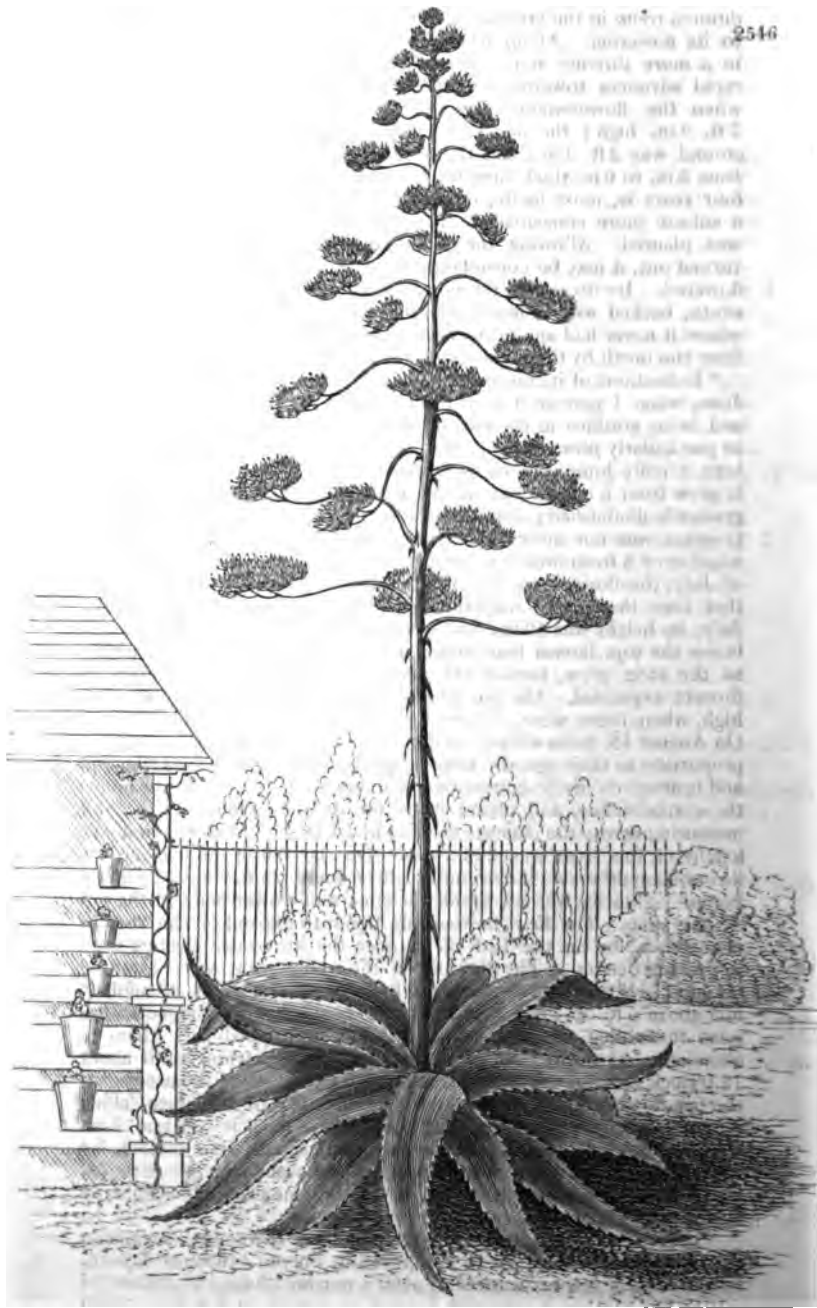

of soil, as the object of planting it out was rather to obtain additional room in the green-house, than any ulterior view with respect to its flowering. About ten years ago, the plant began to appear in a more thriving state; and, during the last four years, it made rapid advances towards maturity. At the latter end of last June, when the flower-stem made its first appearance, the plant was 7 ft. 2 in. high; the diameter of the trunk, at 1 ft. 8 in. from the ground was 2 ft. 3 in.; and the leaves 7 ft. 3 in. long, 13 in. wide, and from 5 in. to 6 in. thick near the base; its rapid growth during the last four years is, most likely, owing to the roots having penetrated into a subsoil more congenial to its growth than the soil in which it was planted. Allowing the plant to be about 25 years old when it turned out, it may be considered as being about 56 years old when it flowered. Its site was in the flower-garden, on a border sloping to the south, backed with a fence and shrubbery as shown in the sketch, where it never had any protection, otherwise than by being screened from the north by the shrubbery behind.

"Indications of its blossoming appeared towards the latter end of June, when I perceived that the central leaves were bursting open; and, being gratified at the idea of seeing it in bloom, I was determined to particularly observe the growth of the flower-stem, and accordingly kept a daily journal of its progress. During the first 10 or 12 days, it grew from 6 in. to 7 in. in 24 hours: afterwards its daily growth gradually diminished; and, when approaching its extreme height, its progress was not more than $\frac{1}{2}$ in. during the above period: cloudy weather or a fresh breeze invariably retarded its growth. On the 1st of July, the flower-stem was 10 ft. 11 in. high, and by many it was at that time thought to resemble a gigantic asparagus. On the 19th of July, its height was 16 ft.; and from that period, at about 4 ft. or 5 ft. below the top, lateral buds began to make their appearance, which, as the stem grew, formed the peduncles on which the clusters of flowers expanded. On the 31st of July, the flower-stalk was 19 ft. high, when there were 13 lateral and alternate shoots thrown out. On August 15. there were 22 peduncles put forth, differing in length in proportion to their age, the lower ones measuring 2 ft. 6 in. in length, and bearing on their extremities numerous clusters of flower-buds; these subdividing, and giving space for each individual flower, and measuring across the clusters from 14 in. to 18 in. At this period, the height of the stem was 22 ft. 6 in. On the 7th of September, the flower-stem attained its extreme height, namely, 25 ft.; and the number of peduncles was 34, besides a cluster of flower-buds on the top of the stem. The first flower-buds began to expand on the 28th of September, and on the 10th of October the lowermost clusters were in great perfection. The flowers on the whole plant were carefully counted, and the number amounted to 5088, of the colour of sulphur, and above 5 in. in length. So richly were the flowers charged with a juice resembling the taste of honey, that it dropped from them in abundance, especially from about 9 o'clock in the morning until about 12 o'clock at noon. Bees came by myriads, and feasted themselves on the fast-flowing fluid. Observing such a quantity of the juice falling on the ground, I put vessels beneath to receive it as it dropped from the flowers, and filled six soda-water bottles with it. After being corked and rested a few days, it was acknowledged to be an excellent cordial; but after a while it fermented, became acid, and acquired a fetid smell.

"From the 10th of October to the middle of November, the stately appearance of the plant, with its gracefully curved branches expanding like candelabra, and sustaining such a number of erect blossoms and

buds, the flowers beautifully succeeding each other, presented to the eye a spectacle highly gratifying. The upper blossoms were in perfection so late as the 24th of December, when, a frost setting in, they were nipped; thus terminating the beauty of a plant that will long live in the recollection of its numerous visitors, the number of which, of all ranks, amounted to 7517. It may be worthy of remark, that, as the flower-stalk grew and the flowers expanded, the leaves of the plant became flaccid and drooping, and are now rapidly withering; but the stalk is still green, and will take several months to get dry.

"During its progress towards flowering, in order to secure it from the wind and rain, I erected over it a temporary covering with pit lights, and underneath a flight of steps to a platform 12 ft. from the ground, which enabled the visitors to approach the lowermost flowers.—*T. Symons. Clowance, Feb. 1838.*"

Plates. Vol. IV. Dele the following, as being varieties distinguished by colour, and, therefore, not suitable for plates which, in the greater number of copies, will not be coloured:—"*Magnolia grandiflora ferruginea* (?), *Tilia europæa glauca* (16), *Tilia europæa rubra* (17)." Dele "*Liriodendron Tulipifera obtusiflora* (14), as being a variety readily understood from description." In a few copies, the plates of *T. (e) álba*, the Hungarian Lime, are named *T. argentea*; and *T. americana* is named *T. álba*. *Acer obtusatum*, in a few copies, is named *A. hybridum*. Though botanists, are well acquainted with these synonyms, we have judged it advisable to name them here, for the sake of the general reader, and to enable the binder to arrange the plates properly.

ERRATA AND ALTERATIONS OMITTED.

ERRATA IN CONTENTS.

Page xix. line 5., for "Bilberbaum," read "Bieberbaum."
 13. for "*Varieties, 272*," read "*Varieties, 278*."
 28. *Liriodendron*, for "Bieberbaum," read "Tulipebaum."
 xx. l. 27., for "295," read "294."
 29. for "29" read "295."
 16. *Berberis*, for "296" read "290."
 xxi. l. 28. *Mahonia*, for "Ash Berry," read "Ash Berberry."
 xxiv. l. 31. *Pittosporum*, for "538," read "358."
 6. *Malvaceæ*, for "362" read "360."
 6. from the bottom, for "633," read "363."
 xxvii. l. 1., for "Lindl.," read "Juss."
 13. *Tilia americana*, for "372," read "373."
 21., after "laxiflora," insert "pl. 21."
 43., for "176," read "376."
 xxix. l. 35. *Hypericum*, for "362," read "366."
 1., for "296," read "398."
 xxxiv. l. 12. *Xanthoxylum*, for "pl. 6," read "pl. 53."
 xxxv. l. 41. *Euclymum latifolium*, for "fig. 631," read "fig. 165."
 15. *E. echinata*, add "fig. 170."
 8. from the bottom, for "501," read "504."
 xxxvii. l. 14. *Prinos verticillatus*, for "523," read "521."
 23., for "l. 191," read "fig. 192."
 41. *Zizyphus vulgaris*, for "594," read "525."
 13. *Palæurus*, for "528," read "527."
 xxxviii. l. 41., for "295" read "535."
 44., for "525," read "535."
 47., for "533" read "535."
 16. *R. Frangula*, for "539," read "537."
 54. *Ceanothus americanus*, insert "fig." before "214."
 xl. l. 27. *Spartium fanceum*, for "575," read "576."
 xlii. l. 1. *Genista radiata*, for "519," read "579."
 43. *G. aphylla*, for "528," read "582."

Page xiv. l. 43. *G. diffusa*, for "584," read "585."
 41. for "fig. 336," read "fig. 303."
 xvi. l. 42. *Colutea media*, for "635," read "633."
 xviii. l. 56. *Cassia*, for "600," read "620."
 iii. l. 18. from the bottom, for "702," read "708."
 liv. l. 28., for "725," read "727."
 6. from bottom, for "*E. alba*," read "*E. alba*."
 iv. l. 3. from the bottom, for "764," read "743."
 lxiii. l. 24., for "603," read "608."
 23., for "663," read "603."
 lxiv. l. 13. from the bottom, dele "*Stranvaia*."
 lxviii. l. 28. from the bottom, for "923," read "922."
 lxxi. l. 14. from the bottom, for "960," read "966."
 lxxxv. l. 16. *Saxifraga*, for "294," read "294."
 lxxxvi. l. 10., for "1018," read "1012."
 lxxxiv. l. 21. from the bottom, for "1131," read "1134."
 xcix. l. 14. from the bottom, for "125," read "1256."
 c. l. 4., for "1364," read "1364."
 cl. l. 26., after "Barbery Boxthorn," insert "fig. 1109. 1370."
 17. from the bottom, for "1115," read "1113."
 For "*Crabowkia*," read "*Grabowkia*."
 cil. l. 3. from the bottom, for "*Salsola* Sp." read "*Salsola* L."
 cxvii. l. 36., for "1509," read "1645."
 cxviii. l. 23. from the bottom, for "168," read "1692."
 cxv. l. 12., for "fig. 1500," read "fig. 1500."

ERRATA IN SUPPLEMENT.

Page 2542. line 23, insert "and" after "tree."
 2568. l. 4., dele "*Jacksbuis scoparia* Cam."
 2565. l. 3. from the bottom, for "fig. 2335," read "fig. 2325."
 2582. l. 12., 13., for "a shows *S. nigra*," &c., read "b shows *S. nigra*, and a *S. Agastria*."

APPENDIX I.

SPECIMEN OF "RETURN PAPERS" CIRCULATED IN 1834 AND 1835; IN GREAT BRITAIN AND NORTH AMERICA, IN ENGLISH; IN FRANCE AND RUSSIA, IN FRENCH; IN ITALY, IN ITALIAN; AND IN GERMANY, DENMARK, SWEDEN, ETC., IN GERMAN.

One large folio sheet contained the Names of all the principal Genera, with blanks under each proportioned to the number of Ligneous Species which each Genus contains.

ARBORETUM ET FRUTICETUM BRITANNICUM;

OR,

THE TREES AND SHRUBS THAT ENDURE THE OPEN AIR IN GREAT BRITAIN AND IRELAND,

PICTORIALLY AND BOTANICALLY DELINEATED, AND SCIENTIFICALLY AND POPULARLY DESCRIBED.

By J. C. LOUDON, F.L.S., &c.

The nature of the *Arboretum Britannicum* is described in the advertisement on the last page of this sheet; and in the *Gardener's Magazine* for December, 1834. The object of this Return Paper is, to procure Notices of Trees and Shrubs, whether old or young, indigenous or foreign, hardy or half-hardy, of all the kinds mentioned below, from all parts of Great Britain, Ireland, and the Continent of Europe.

The Proprietor, Amateur, Nurseryman, Gardener, or Forester, who may receive this Paper, will greatly serve the cause of Arboriculture, if he will fill up with the names and other particulars of such species of the genera enumerated as may be on his property, within the range of his observation, or under his care. The objects are: 1. To show the different degrees of progress which trees make in different localities and climates, and in different soils and situations; 2. To record the Arboretums, and also the smaller Collections of Trees and Shrubs that have been made in different places; and, 3. To notice Specimens remarkable for their bulk, age, beauty, singularity, or peculiarity of form; or, in the case of very young trees, for their rapidity of growth. It is requested that this sheet, when filled up, may be returned to the undersigned, at Messrs. Longman's, 39, Paternoster Row, London, at the earliest convenience of the party to whom it is addressed.

J. C. LOUDON.

London, Nov. 1834; May, 1835; and July, 1835.

Generic and Specific Names.	Recent Age, or Number of Years planted.	Height, as compared to the standard in the Field.	Height trained against a Wall, in English Feet.	Circumference of the Trunk, in Feet from the Ground, in Inches.	Diameter of the Spine covered by the Bark, in Feet.	Shape of the Head; as, whether round, oval, compact, loose, regular, or irregular.	Soil; and whether trenched and prepared, or not prepared.	Substratum; and whether moist or dry.	Situation and Exposure.	Name of the Place where the Tree grows; and Remarks concerning Propagation, Culture, Management, Uses, &c.
Magnolia.										
Liriodendron. Tilia.										
Acer.										
Negundo										

APPENDIX II.

LIST OF TREES AND SHRUBS INDIGENOUS TO, OR CULTIVATED IN, ITALY,
WITH THEIR SYSTEMATIC AND POPULAR ITALIAN NAMES.

Communicated by Signor Giuseppe Manetti, of the Administration of the Imperial and Royal Gardens at Monza, in Lombardy.

Systematic Names.	Italian Names.	Systematic Names.	Italian Names.
Ranunculaceae.		Heliánthemum - Eliantemo.	
<i>Clematis</i> -	- Clematide o Clematite.	<i>vulgare</i> -	- Eliantemo, Panace chironio.
<i>Flammula</i> -	- Clematide odorosa, Flammola, Flammola, Vitalba viticcio, Vitalba piccola, Viticcio.	<i>spenninum</i> -	- Erba bottoncina.
<i>Vitalba</i> -	- Vitalba, Clematide, Vite bianca, Vitalba comune, Fior di minue, Viorna.	Caryophyllaceae.	
<i>Viorna</i> -	- Vitalba viorna.	<i>Dianthus</i> -	- Garofano.
<i>cylindrica</i> -	- Vitalba dai fiori lunghi.	<i>Caryophyllus</i> -	- Fior di garofano, Garofano domestico, Viola, Viola comune, Viola di cinque foglie, Viola garofanata, Viola scempra, Violina.
<i>Simsii</i> -	- Vitalba dalle foglie cordate.	Malvaceae.	
<i>florida</i> -	- Viticcio dai fiori grandi.	<i>Hibiscus</i> -	- Ibisco.
<i>Viticella</i> -	- Viticcio, Vitalba pavonazza, Vitalbino, Clematide assurra.	<i>syriacus</i> -	- Chetmia, Ketmia, Ibisca.
<i>crispa</i> -	- Clematide dai fiori cresputi.	Tiliaceae.	
<i>balearica</i> -	- Vitalba di Maone.	<i>Tilia</i> -	- Tiglia.
Winteraceae.		<i>europaea</i> -	- Tiglia, Tilia, Tiglia femmina, Tiglio.
<i>Illicium</i> -	- Badiana o Badiano.	Camelliaceae.	
<i>amblytum</i> -	- Anicio stellato o stellare, Badiana, Finocchio della China.	<i>Thea</i> -	- Tè.
Magnoliaceae.		<i>viridis</i> -	- Tè, The, The verde.
<i>Magnolia</i> -	- Magnolia.	<i>Bobis</i> -	- Tè, The, The Bè, The Ban, The Congo, The Congo ordinario, The bylan, The nero, The puro, The polvere da munitione, The scuro.
<i>grandiflora</i> -	- Magnolia, Tulipano.	Hypericaceae.	
<i>glauca</i> -	- Albero di castoreo.	<i>Hypericum</i> -	- Iperico.
<i>conspicua</i> -	- Magnolia dai fiori di giglio.	<i>calycinum</i> -	- Asciro.
<i>Liriodendron</i> -	- Liriodendro.	<i>Androsæmum</i> -	- Androsæmo.
<i>Tulipifera</i> -	- Tulipiere, Tulipifero.	<i>fasciculatum</i> -	- Androsæmo, Ciciliana.
Anonaceae.		Aceraceae.	
<i>Asimina</i> -	- Asimina.	<i>Acer</i> -	- Acero.
<i>triloba</i> -	- Annona.	<i>spicatum</i> -	- Acero di montagna.
Menispermaceae.		<i>striatum</i> -	- Acero screziato.
<i>Cocculus</i> -	- Coccoło.	<i>platanoides</i> -	- Acero riccio, Platano aquatico, Platamaria, Pio d'oca, Platano maggiore, Platano di Norvegia, Sicomoro falso.
<i>carolinus</i> -	- Gallia di Levante?	<i>saccharinum</i> -	- Acero del Canada, Acero zucchero.
Berberaceae.		<i>Pseudo-Platanus</i> -	- Acero Fico, Acero Sicomoro, Acero tiglio, Loppo, Platano falso, Platano salvatico, Testucchio quercino, Acero di montagna, Acero bianco.
<i>Berberis</i> -	- Berbero.	<i>O'palus</i> -	- Acero, Loppo.
<i>vulgaris</i> -	- Berberi, Berberi ordinario, Berbero, Crespino, Spina acida, Spino vinetto, Spina santa, Ossicanta.	<i>campêtre</i> -	- <i>Le piccolo piemontese si chiamava Galluzzi, e l'altro grande ha il nome di Loppo.</i> Pioppo, Chioppo, Stucchia, Festucchio, Pistacchia, Albero da vite.
<i>asperma</i> -	- Berbero senza semi.	<i>opulifolium</i> -	- Acero di Spagna, Acero d'rotto.
Capparidaceae.		<i>erlocarpum</i> -	- Acero otonoso, Acero bianco, Acero spugnoso, Acero à Virginia.
<i>Capparis</i> -	- Capperò.	<i>monspessulanum</i> -	- Acero minore, Albero lattejolo, Acero piccolo.
<i>spinosa</i> -	- Capperò, Capperò.		
Cistaceae.			
<i>Cistus</i> -	- Cisto.		
<i>villosus</i> -	- Cisto maschio.		
<i>incanus</i> -	- Cisti, Cisto, Cisto maschio, Cisto rosso.		
<i>creticus</i> -	- Ladano, Ladano di Barba, Gomma Ladano.		
<i>salvifolius</i> -	- Cisto femmina, Brentine, Scornabeco, Spazza berrette, Muccoli.		
<i>monspeliensis</i> -	- Brentine, Imbrentino, Imbrentine, Muschio, Mustio, Pisciacane, Bimbrentine, Fignamica, Fignamicone.		
<i>ladaniferus</i> -	- Ladano, Ladano di Portogallo.		

Systematic Names.	Italian Names.
<i>Negundo fraxinifolium</i>	- Negundo. - Acero americano, Acero della Virginia, Acero a foglie di Frassino, Nigundo.
<i>Esculideae.</i>	
<i>Hippocastanum</i>	- Ippocastano. - Marrone d'India, Castagna cavallina, Ippocastano.
<i>Pavia rubra</i>	- Pavia.
<i>flava</i>	- Marrone di Paw, Pavia.
<i>macrostachya</i>	- Marrone d'India giallo, Pavia gialla.
<i>Sapindaceae.</i>	- Pavia bianca.
<i>Kolreuteria paniculata</i>	- Cōlireuteria. - Cōlireuteria.
<i>Meliaceae.</i>	
<i>Melia asedarach</i>	- Melia. - Albero de' Paternostri di San Domenico, Pasiensa, Ase-darach, Seccomoro, Sicomoro, Sicomoro falso, Zaccheo, Asarac, Azabrach, Ased-rach.
<i>Vitaceae.</i>	
<i>Vitis vinifera</i>	- Vite. - Uva, Vigna, Vite, Vite domestica, Vite da Vino.
<i>Labrusca</i>	- Abrostine, Abrostino, Abrostolo, Abrostolo forte, Abrostolo salvatico, Abruschi, Colore, Lambrusca, Ravrustico, Ravrusto, Uva abroetine, Uva abrotine, Uva lambrusca, Uva lambrusca, Uva Raverustio, Uva Raverustio forte, Uva salvatica, Uva sampina, Tinta, Uvisolo, Vite salvatica.
<i>laciniata</i>	- Uva e Vite d' Egitto, Uva e Vite di Gerusalemme, Uva e Vite Spagnola, Uva e Vite maravigliata.
<i>Ampelopsis acerifolia</i>	- Ampeloida.
<i>bipinnata</i>	- Vite del Canada. - Vite della Carolina a foglie di pressemolo.
<i>Zygophyllaceae.</i>	
<i>Mellanthus major</i>	- Mellanto.
<i>minor</i>	- Mellanto.
<i>Rutaceae.</i>	
<i>Ruta graveolens</i>	- Ruta. - Ruta.
<i>Xanthoxyloideae.</i>	
<i>Xanthoxylum fraxineum</i>	- Santossilo. - Frassino spinoso.
<i>Ptelea trifoliata</i>	- Ptelea.
<i>Allantia glandulosa</i>	- Ptelea. - Allanto. - Albero di Paradiso, Allanto.
<i>Coriaceae.</i>	
<i>Coriaria myrtifolia</i>	- Coriaria. - Coriaria.
<i>Staphyleaceae.</i>	
<i>Staphylea pinnata</i>	- Stafilea. - Lacrime di Globbe, Naso mosso, Pistacchio falso, Pistacchio salvatico.
<i>Celastraceae.</i>	
<i>Evonymus europaeus</i>	- Evonimo. - Berette da prete, Corallini, Evonimo, Fusaggine, Fusano, Fusario, Fusaria apennina, Rulatico salvatico, Tetragonia.
<i>verrucosus</i>	- Fusaria verrucosa.
<i>latifolius</i>	- Fusaria maggiore.

Systematic Names.	Italian Names.
<i>Aquifoliaceae.</i>	
<i>Ilex aquifolium</i>	- Ilice. - Agrifoglio o Agrifoglio, Alloro spinoso, Leccio spinoso, Aquifoglio, Pisciatopo, Pungitopo maggiore. - Agrifoglio a foglie di quercia.
<i>opaca</i>	- Cassine.
<i>Cassine vomitoria</i>	- Cassine. - The americano, Peragus, Apalachina.
<i>Rhamnaceae.</i>	
<i>Zisypus lotus</i>	- Giuggiolo. - Loto, Zissolo salvatico.
<i>vulgaris</i>	- Giuggiolo, Zizzolo, Giuggiola, Zussola.
<i>Paliurus aculeatus</i>	- Palluro. - Giuggiolo salvatico, Marruca, Marruca nera, Palluro, Piattini, Plaustrini, Ramno palluro, Soldino, Spina giudaica, Spina Marruca, Spino gatto.
<i>Rhamnus alaternus</i>	- Ramno. - Alaternà, Alaterno, Aino nero, Ilastro, Ietro, Linterna, Linterno, Legno puzzo, Putine.
<i>catharticus</i>	- Ramno catartico, Ramno, Spin cervino maggiore, Spin cervino, Spin mario, Spin quercino.
<i>infectarius</i>	- Grana d'Avignone, Spin cervino.
<i>saxatilis</i>	- Licio italiano.
<i>oleoides</i>	- Licio olivastro.
<i>persicifolius Bert.</i>	- Licio persichino.
<i>alpinus</i>	- Ranno alpino, Aino nero alpino.
<i>pumilus</i>	- Ranno spaecassasi.
<i>Frangula</i>	- Aino nero, Frangola, Frangula, Putine, Spin cervino minore.
<i>Ceanothus americanus</i>	- Ceanoto. - Ceanoto.
<i>Hamamelidaceae.</i>	
<i>Aristotelia</i>	- Aristotelia.
<i>Mocquet</i>	- Maqui.
<i>Anacardiaceae.</i>	
<i>Pistacia vera</i>	- Pistacchio. - Pistacchio, Pistacchio verde.
<i>trifolia</i>	- Pistacchio, Pistacchio gallo.
<i>Terebinthus</i>	- Terebinto, Corno capra, Legno di Terebinto.
<i>Leniscus</i>	- Corno capra, Dentisco, Dentisco, Lentisco, Lentisco, Mastice, Mastice, Mastice, Sondro, Sonnolo, Stirochi, Versura da far feste.
<i>Rhus</i>	- Rù.
<i>Cotinus</i>	- Cotino, Roso, Ruoso, Scotano.
<i>Cotinus soredi albo</i>	- Capeccchio.
<i>typhina</i>	- Sommacco peloso, Sorbo salvatico.
<i>Coriaria</i>	- Sommacco, Rù.
<i>Toxicodendron</i>	- Albero del velono, Tossico-dendro.
<i>vernix</i>	- Albero della vernice.
<i>Schinus</i>	- Schino.
<i>Mulle</i>	- Albero del pepe, Falso pepe, Lentisco del Perù, Molle, Molle indiano, Pepe falso, Pepe molle, Schino, Terebinto della China.
<i>Leguminosae.</i>	
<i>Ulex europaea</i>	- Ulice. - Ginestra spinosa, Ginestrone, Ginestrone d' Olanda, Ginestrone spinoso, Spalatrone, Spinorasso.
<i>Spartium junceum</i>	- Sparzio. - Ginestra, Genestra, Ginestra di Spagna.

Systematic Names.	Italian Names.	Systematic Names.	Italian Names.
<i>Genista</i> -	- Ginestra.	<i>Pérsea</i> -	- Pesco.
<i>cándicans</i> -	- Ginestra pelosa.	<i>vulgáris</i> -	- Pesco (e il frutto Pesca, Pesca duracina e Pesca spiccata).
<i>germánica</i> -	- Bullinacola di bosco.	<i>la'vis</i> -	- Pesca noce.
<i>tinctória</i> -	- Baccellina, Braglia, Cerretta, Coaria, Ginestra, Ginestra salvatica, Ginestrella, Ginestrina, Ginestrola, Ginestrasza, Guado bastardo Guado salvatico.	<i>la'vis, the free-stone nectarine</i> -	- Pesca noce che spicca.
		<i>la'vis, the cling-stone nectarine</i> -	- Pesca noce che non spicca.
<i>áfrica</i> -	- Stecchi.	<i>Armeníaca, vulgáris</i> -	- Armeniaca, Alicercoco, Armellini, Pesco americano, Miliaco, Umiliaco (il frutto Alicocca).
<i>Cytisus</i> -	- Citiso.	<i>Prúnus</i> -	- Pruno.
<i>Labúrnea</i> -	- Abornello, Anagiri minore, Avornello, Avornello, Avorno, Bornello, Bendoli, Ciondolino, Eghelo, Maggio ciondolino, Majella, Majo Laburno, Liburno, Ebanò falso.	<i>spínosa</i> -	- Prugno, Prugnolo, Prunello, Pruno con frutti neri, Pruno salvatico, Spino nero, Susino o Susina di macchia, Susma prugnola, Vepro.
		<i>doméstica</i> -	- Pruno, Susino, Susino domestico (il frutto Susina).
<i>alpinus</i> -	- Anagiri minore, Anagiri primo, Avornello, Maggio ciondolo.	<i>Cérusus</i> -	- Ciliegio.
<i>nigricans</i> -	- Maggio, Citiso spigato.	<i>syvéstris</i> -	- Ciriegolo, Cirigliolo.
<i>genistae-folius</i> -	- Citiso ginestrino, Majello, Trifoglio de' giardinieri.	<i>vulgáris</i> -	- Ciliegio, Ciriegio, Marasca.
<i>scopáris</i> -	- Amaracchiole, Ginestra da granate, Ginestra de' carbonai, Scornabecco.	<i>Chamaecérusus</i> -	- Ciriegolo, Ciriegola.
		<i>Mahaleb</i> -	- Legno o Albero di Santa Lucia, Ciliegio camino, Mahlebo.
<i>Amórpha</i> -	- Amoria.	<i>Párus</i> -	- Ciliegio ramoso.
<i>fruticosa</i> -	- Indaco bastardo, Barba di Giove, Amorosa, Smoria.	<i>Laurocérusus</i> -	- Lauro, Lauro di Trobisanda, Lauro regio, Lusero.
<i>Robínus</i> -	- Robinia.	<i>Spiráa</i> -	- Spirea.
<i>Pseud-Acacia</i> -	- Acacia, Falsa Acacia, Pseud-acacia, Robinia.	<i>opullifolia</i> -	- Evonimo del Canada.
<i>viscosa</i> -	- Robinia di fior rosso, Robinia rossa.	<i>Róbus</i> -	- Rovo.
<i>hispida</i> -	- Robinia di fior rosso, Robinia pelosa, Robinia rosea.	<i>ida'us</i> -	- Ampomelle, Frambo, Lappone, Lamponia, Rovo loro.
<i>Caragána</i> -	- Caragana.	<i>fruticósus</i> -	- Rogo, Rogo di macchia, Rovo, Rovo montano.
<i>arboréscens</i> -	- Caragana, Caragana di Siberia.	<i>ca'rius</i> -	- Rogo di fior bianco.
<i>Colútea</i> -	- Colutea.	<i>odorátus</i> -	- Rogo del Canada.
<i>arboréscens</i> -	- Colutea, Erba vesticaria, Senna de' poveri, Senna falsa, Senna nostrale, Maggiorana, Fruscoli del Bossoli.	<i>Rósa</i> -	- Rosa.
<i>Anagiris</i> -	- Anagiride.	<i>agréstis Savi</i> -	- Rosa di macchia, Roselline di macchia, Rovo camino.
<i>foetida</i> -	- Anagiri, Angride, Fagiolo della Madonna, Fava lupina, Fava inversa, Olio della Madonna, Putine, Fascolaria?	<i>arvénis</i> -	- Rosa di macchia, Rosa dommaschina salvatica, Rosa lustra, Roselline di macchia, Roselline de' pruni, Rovo camino.
<i>Astrágalus</i> -	- Astragalo.	<i>centifolia</i> -	- Rosa a bottoni, Rosa di cento foglie.
<i>Tragacántha</i> -	- Dragante, Diagrante.	<i>collina</i> -	- Rosa di macchia, Roselline di macchia, Rovo camino.
<i>Coronilla</i> -	- Coronilla.	<i>Eglantéria</i> -	- Rosa gialla, Rosa di cimice.
<i>Emérus</i> -	- Emmero, Ginestra di bosco, Maggio piccolo.	<i>Eglantéria punicea</i> -	- Rosa di due colori.
<i>Medicágo</i> -	- Medica.	<i>gálica</i> -	- Rosa comune, Rosa d'ora, Rosa mistica.
<i>arborea</i> -	- Citiso.	<i>gálica calyce folideo</i> -	- Rosa in calice.
<i>Gleditsiáa</i> -	- Gleditsia.	<i>gálica majalis</i> -	- Rosa magresse, Rosa di Maggio.
<i>triacánthos</i> -	- Acacia spinosa, Gleditsia spinosa, Fava americana.	<i>gálica prolifera</i> -	- Rosa fior in fiore.
<i>triacánthos inermis</i> -	- Falsa gaggia, Acacia inermis, Gleditsia.	<i>lútea</i> -	- Rosa cimice.
<i>Cércis</i> -	- Cerchi.	<i>moscháta</i> -	- Rosa dommaschina, Rosamochetta, Rosa muschiata, Roselline dommaschine.
<i>Siliquástrum</i> -	- Albero di Giuda, Albero di Giudea, Siliquastro.	<i>máxima Desf.</i> -	- Rosa d' Olanda.
<i>Ceratónia</i> -	- Ceronia.	<i>multiflora</i> -	- Rosa della Granduchessa.
<i>Silíqua</i> -	- Carate, Caroba, Carobe, Carobole, Carube, Carruba, Carrubio, Carrubo, Guanelia, Siliqua, Siliqua dolce, Baccelli greci, Baccelli dolci.	<i>muscosa</i> -	- Rosa borracina.
<i>Acácia</i> -	- Acacia.	<i>sempiflora</i> -	- Rosa di macchia, Roselline di macchia.
<i>Julibrissin</i> -	- Gaggia arborea, Albero della seta, Gaggia di Costantinopoli, Julibrissin, Julibrissin.	<i>sempervirens</i> -	- Caccabelli, Rosa di macchia, Rosa dommaschina salvatica, Rosa lustra, Roselline di macchia, Roselline di pruno, Rovo camino.
<i>farneziána</i> -	- Gaggia, Gaggia odorosa, Gaggio.	<i>spinostáxima sulphúrea</i> -	- Rosa salvatica.
		<i>gálica</i> -	- Rosa gialla.
		<i>syvéstris</i> -	- Rosa camina, Rosa salvatica.
		<i>Crataegus</i> -	- Cratègo.
		<i>Pyracántha</i> -	- Agazzino, Pruno gazzeria, Marruca nera.
Rosácea.		<i>Azardus</i> -	- Azzeruolo, Azzeruolo, Azzeruolo, Lasserolo, Lasserolo, Lasserolo piccola rosa, Lasseruolo, Lasseruolo, Pomo imperiale, Tricocco, Lasserolo vero.
<i>Amygdalus</i> -	- Mandorlo.		
<i>nána</i> -	- Peschino della China.		
<i>orientális</i> -	- Mandorlo argenteo.		
<i>communis</i> -	- Mandorlo, Mandolo (e il frutto Mandorla).		
<i>pùmila</i> -	- Mandorlo doppio.		

Systematic Names	Italian Names
<i>Cr. Crda-galli</i> -	- Lasseruolo rosso, Lassarolo spinoso.
<i>granifolia</i> -	- Lasseruolo.
<i>pyrifolia</i> -	- Lasserolo perino.
<i>coccinea</i> -	- Lasseruolo rosso.
<i>Borentina Zuech.</i> <i>Mesp. florentina</i> Bert.	- Pero lasserolo, Pero lasserolino, Lasserolo salvatico.
<i>Pyrus cratagifolia</i> Oct., Targ., Toss.	
<i>Oxyacantha</i> -	
	- Acanta da siepe, Assarolo salvatico, Bianco spino, Lassaruolo salvatico, Marruca bianca, Ostaranta, Panceri, Pruno agazzino, Pruno guazzino, Ramno spina bianca, Spin bianco, Spin nero, Spin tordellino, Spina bianca, Spina topiaria, Spina topiazza.
<i>tanacetifolia</i> -	- Lasseruolo turco.
<i>Cotoneaster</i> -	- Cotognastro.
<i>vulgaris</i> -	- Salciagnolo, Cotognastro, Cotonastro, Cotonastro del Geanero, Nespolo cotognastro.
<i>tomentosa</i> -	- Cotognastro cotonoso.
<i>Amelanchier</i> -	- Amelanchier.
<i>vulgaris</i> -	- Pero carvino, Bagole.
<i>Mespilus</i> -	- Nespolo.
<i>germanica</i> -	- Nespolo.
<i>Pyrus</i> -	- Pero.
<i>communis</i> -	- Pero, Pero domestico (il frutto Pera).
<i>Malus</i> -	- Melo, Pomo (il frutto Mela).
<i>Malus sylvestris</i> -	- Mela salvatica, Melo salvatico, Melagnolo, Meluggine.
<i>Aria</i> -	- Lasseruolo di montagna, Matello, Sorbo montano.
<i>terminalis</i> -	- Ciavardello, Baccarello, Mangiarello.
<i>aseuparia</i> -	- Sorbo lasserola salvatica otobrino, Sorba salvatica otobrino, Sorbo salvatico, Sorba della Ragnaja del Palagio di Gianfigliassi, Sorba della Romola.
<i>Sorbus</i> -	- Sorbo, Sorbo domestico.
<i>Chamaemespilus</i> -	- Camenespolo.
<i>Cydonia</i> -	- Cotogno.
<i>vulgaris</i> -	- Cotogno, Melo cotogno, Pero cotogno. (Il frutto Cotogno, Mela cotogna, Pera cotogna.)
<i>Eriobotrya</i> -	- Eriobotria.
<i>japonica</i> -	- Nespolo del Giappone.
<i>Calycanthaceae.</i>	
<i>Calycanthus</i> -	- Calicanto.
<i>floridus</i> -	- Calicanto, Pompador.
<i>Granatidæe.</i>	
<i>Punica</i> -	- Punica.
<i>Granatum</i> -	- Melograno, Granato. (Il frutto Melagrano, Granata.)
<i>Granatum sylvestre</i> -	- Melograno forte, Melagrano salvatico. (Il frutto Melagrano salvatica.)
<i>Tamaricidæe.</i>	
<i>Tamarix</i> -	- Tamarice.
<i>gallica</i> -	- Mirice, Tambrice, Tamarice, Tamarigia, Tamerice, Tamerige, Tamerigia, Tamerigio, Tamerisco, Tamarice, Tamerice, Scoopa marina.
<i>Myricaria germanica</i> -	- Tamarigia piccola.
<i>Philadelphidæe.</i>	
<i>Philadelphus</i> -	- Filadelfo.
<i>coronarius</i> -	- Fior angelo, Gelsomino della Madonna, Salindia, Salinga, Siringa, Erba siringa.
<i>Inodrus</i> -	- Sillindia senza odore.

Systematic Names	Italian Names
<i>Myrtidæe.</i>	
<i>Myrtus</i> -	- Mirto.
<i>communis</i> -	- Mirtella, Mirto, Mortella, Mortina, Mortine.
<i>communis baetica</i> -	- Mortella di Spagna, Mortelle doppie.
<i>communis tarentina</i> -	- Mortelle di foglie piccole, Mortellina.
<i>Passifloridæe.</i>	
<i>Passiflora</i> -	- Granadiglia.
<i>cærulea</i> -	- Fior di passione, Granadiglia.
<i>Grossulidæe.</i>	
<i>Ribes</i> -	- Ribes.
<i>rubrum</i> -	- Ribes, Ribes rosso, Ribes volgare.
<i>petraeum</i> -	- Ribes corallino.
<i>nigrum</i> -	- Ribes nero.
<i>Grossularia</i> -	- Grossularia, Uva spina, Uva crispina, Uva crista, Uva dei Frati, Uva marina.
<i>Saxifragæe.</i>	
<i>Hydrangea</i> -	- Idrangea.
<i>Hortensia</i> -	- Ortensia.
<i>radiata</i> -	- Idrangea.
<i>Aralidæe.</i>	
<i>Panax</i> -	- Panace.
<i>quinquefolia</i> -	- Ginsang, Ginseng, Ginzag.
<i>Aralia</i> -	- Aralia.
<i>spinosa</i> -	- Angelica spinosa, Aralia.
<i>Hedera</i> -	- Edera.
<i>Hélix</i> -	- Edera, Ellera, Ellera arborea, Lellera.
<i>Hamamelidæe.</i>	
<i>Hamamelis</i> -	- Amamelide.
<i>virginica</i> -	- Pistacchio nero della Virginia.
<i>Cornidæe.</i>	
<i>Cornus</i> -	- Corniolo.
<i>sanguinea</i> -	- Erba sanguinella, Risanguine, Sanguina, Sanguigno, Sanguinello, Verna sanguigna.
<i>mas</i> -	- Corngnolo, Cornalo, Cornio, Corniolo maschio, Corno, Corngnolo, Sanguine maschio.
<i>Loranthidæe.</i>	
<i>Viscum</i> -	- Visco.
<i>album</i> -	- Vischio, Veschio, Visco, Visco quercino, Pania Vischiata, Panfala.
<i>Aucuba</i> -	- Aucuba.
<i>japonica</i> -	- Aucuba.
<i>Caprifoliidæe.</i>	
<i>Sambucus</i> -	- Sambuco.
<i>nigra</i> -	- Sambuco, Sambuco montano, Zambuco, Zambuco arboreo.
<i>racemosa</i> -	- Sambuco montano, Sambuco racemoso.
<i>laciniata</i> -	- Sambuco o Zambuco intagliato.
<i>Viburnum</i> -	- Viburno.
<i>Tinus</i> -	- Lagro salvatico, Lauro salvatico, Lauro Tino, Legno lano, Lentaggine Tino, Aloro Tino.
<i>Lantana</i> -	- Lantana, Lentaggine, Varvona, Viburna, Vavorna.
<i>O'pulus</i> -	- Maggi, Maggio, Pallone, Pallone di Maggio, Pallone di neve, Sambuco aquatico.
<i>levigatum</i> -	- The americano.
<i>Diervilla</i> -	- Diervilla.
<i>humilis</i> -	- Diervilla.
<i>Lonicera</i> -	- Lonicera.
<i>Periclymenum canescens</i> -	- Madreselva, Periclimeno, Madreselva parasole, Falso Gisliotto.

Systematic Names.	Italian Names.	Systematic Names.	Italian Names.
<i>L. Caprifolium</i>	Abbracciabosco, Abbracciadonne, Bracciabosco, Caprifoglio, Caprifoglio, Erba manina, Madreselva, Manine, Matriselva, Periclimeno, Vincibosco.	<i>A. procumbens</i>	- <i>Assaba</i> , Bosso alpina.
etrusca -	- Mansorino, Madreselva, Mansorino, Matriselva, Vincibosco.	<i>Vaccinium</i>	- Vaccino.
impléxa -	- Vincibosco sempreverde.	<i>Myrtillus</i>	- Basseri, Baccole, Baggjoli, Baggoli, Bagule, Mirtillo, Uva orsina.
nígra -	- Ciliegia salvatica.	<i>Vitis ídea</i>	- Vigna d'orso, Vite del monte Ida, Vite ídea.
gráta -	- Caprifoglio sempreverde.	<i>Styrácea.</i>	
<i>Xylósteum</i>	- Gisilostio, Madreselva pelosa.	<i>Styrax</i>	- Storace.
alpígena -	- Cameceraso, Ciliegia d'Alpe.	officialé -	- Storace, Storace calamita, Molo cotogno salvatico.
cerúlea -	- Ciliegia alpina cerulea.	<i>Ebenácea.</i>	
sempervirens	- Madreselva di Virginia, Madreselva a fior scarlatto.	<i>Diospyros</i>	- Diospiro.
<i>Rubídcea.</i>		<i>Lótus</i>	- Albero di Sant Andrea, Datoli di Trebisonda, Ebano nero femmina P, Ermellino, Loto, Loto africano, Loto d'Africa, Loto d'Egitto, Loto falso, Guajacama, Guajaco falso, Guaiaco legno santo.
<i>Cephalánthus occidentális</i>	- Cefalanto.	<i>Oleácea.</i>	
<i>Compósita.</i>		<i>Ligústrum</i>	- Ligustro.
<i>Santolma</i>	- Santolina.	vulgáre -	- Ligustro, Iastro, Olivella, Ruistico, Rovatico, Sanguinello, Vincastruzzo, Luistico, Luistico, Ruischio.
<i>Chamaecyparissus</i>	Abrotano femmina, Canapechia, Crespolina, Erba vermicolare, Santolina, Vermicolare.	<i>Phillyrea</i>	- Fillirea.
<i>Artemísia</i>	- Artemisia.	média -	- Filaria, Fillirea, Lillatro di foglie mezzane, Iastro, Iastro, Lillatro, Ulivastro.
<i>Abrotanum</i>	- Abrotano, Abrotano maschio, Abrotina, Abrotino, Abrotano, Abruotino, Abruotino.	angustifólia -	- Filaria, Fillirea, Iastro, Iastro, Lillatro da foglie strette, Ulivastro.
<i>Santónica</i>	- Santonico.	latifólia -	- Filaria, Fillirea, Iastro, Iastro, Lillatro, Lillatro di foglia larga, Ulivastro.
<i>Hellebrýsum</i>	- Elliciso.	stricta -	- Fillirea, Lillatro pertichino.
<i>Stoechas</i>	- Bambagia salvatica, Brencli, Canapechia, Stecade citrina, Tignamica, Tignamica terragnola.	<i>Chionánthus</i>	- Chionanto.
<i>Cinerária</i>	- Cineraria.	virginica -	- Albero di neve.
<i>marítima</i>	- Cenerina, Cineraria.	<i>Olea</i>	- Olivo.
<i>Ericácea.</i>		européa -	- Oleastro, Olivagnolo, Olivo salvatico, Ulivagnina, Ulivagnolo, Ulivastro.
<i>Erica</i>	- Erica.	européa cajetána -	- Olivo gaetano.
arbórea -	- Scopa, Scopa arborea, Scopa da fastella, Scopa bianca, Scopa maggiore, Scopa da bacchi, Scoconi da boschi.	<i>Syríngis</i>	- Liliaco.
cinérea -	- Scopa.	vulgáris -	- Liliac, Liliaco, Lilia, Liliac turco.
pupuráscens	- Gonfia nugoli.	pérfica -	- Liliac, Liliac di Persia.
scopária -	- Scopa, Scopa da granate, Scoparia.	Fontanénsis -	- Fontanesia.
<i>Tétralix</i>	- Scopa di fior rosso.	phillyreóides -	- Ligustro di Siria.
multifóbra -	- Scopa grande rosso.	Fraxínus -	- Frassino.
Callúna	- Calluna.	excélsior -	- Frassino, Frassinone, Nocione.
vulgáris -	- Brentoli, Cecchia, Checchia, Crecchia, Gonfia nugoli, Scopa, Scopa meschina, Scopa piccola, Sorcelli, Sorcelli.	parvifólia -	- Frassino mistino, Frassinone, Lentisco.
<i>Andrómeda</i>	- Andromeda.	<i>O'rus</i>	- Orno.
specíbea -	- Andromeda polvarosa.	européa -	- Orno, Ornello, Ornello, Avornello, Avornolo, Cortolo.
lícida -	- Andromeda dalle foglie marginate.	rotundifólia -	- Orno piccolo, Ornello frutice.
polifólia -	- Andromeda a foglie ripiegate.	argétea -	- Ornello argentino, Ornello di Corsica.
<i>Albúta</i>	- Albatro.	<i>Jasminácea.</i>	
integrifólia	- Andrachne, Andrachne di Teofrasto.	<i>Jasminum</i>	- Gelsomino.
<i>Unedo</i>	- Albatro, Albatro corallino, Albatrello, Albatresto, Albatro, Arbuto, Briachella, Corbezolo, Rossello (e il frutto chiamasi dal popolo coi nomi di Corbezola, Albatro, Albatrelle, Ciliege marine, Rosselle, Mompomi, Urie, Marmotte).	fráticans -	- Gelsomino giallo.
<i>Andrachne</i>	- Falso Andrachne, Albatro pannocciato.	húmíle -	- Gelsomino giallo.
<i>Arctostáphylos</i>	- Uva d'orso, Uva orsina, Uva ursi.	officialé -	- Gelsomino, Gelsomino bianco o ordinario, o salvatico.
<i>Uva-ursi</i>	- Albatro delle Alpi.	<i>Apocynácea.</i>	
alpína -	- Rododendro.	<i>Vínca</i>	- Vinca.
<i>Rhododéndron</i>	- Cisto di Virginia.	minor -	- Erba Vinca, Fior da morta, Mortine.
<i>viscúsum</i>	- Rododendro.	major -	- Ciematide, Erba vinca, Fior da morto, Mammolose, Mortine, Provincia, Vinca, Vinca perrinca, Vinchia, Viola da morti, Viorna.
ferrugíneum	- Rododendro.	acutifóbra Berr.	- Morzine maggiore, Morzina nera pelosa, Morzine di fiori celesti.
<i>Azalea</i>	- Azalea.	<i>Nerium</i>	- Nerio.

Systematic Names.	Italian Names.	Systematic Names.	Italian Names.
<i>N. Oleander</i> -	- Ammassa l'Asino, Erba da rognà, Lauro roseo, Leandro, Mazzo di San Giuseppe, Nerio Oleandro.	Lauràcea.	
Asclepiadàcea.		<i>Laurus</i> -	- Lauro.
<i>Periploca</i> -	- Periploca.	<i>nobilis</i> -	- Alloro, Lauro, Orbaco.
<i>græca</i> -	- Apocino serpeggiante, Periploca, Topi, Erba del Signore.	<i>Sassafras</i> -	- Sassafrasso.
<i>angustifolia</i> Pers.	- Scornabecco.	Thymelàcea.	
<i>Syn.</i>		<i>Dâphne</i> -	- Dafne.
<i>Gomphocarpus</i> -	- Gomfocarpo.	<i>Mentacum</i> -	- Laureola femmina, Biondella, Camela, Calmolea, Mesereo, Mesereon, Dafnoide.
<i>iruticibus</i> -	- Lino d'India, Albero o Pianta della seta, Seta d'India.	<i>Laurèola</i> -	- Cavolo di lupo, Erba coccona, Laureola, Olivella, Pepe montano.
Bignoniàcea.		<i>alpina</i> -	- Olivella.
<i>Bignonia</i> -	- Bignonia.	<i>Gnidium</i> -	- Camelea, Cocco gnidio, Pepe montano, Ulivello.
<i>capreolata</i> -	- Tetrafilia, Bignonia aranciata.	Santalàcea.	
<i>Tecoma</i> -	- Tecoma.	<i>Osyris</i> -	- Ostride.
<i>radicans</i> -	- Bignonia, Gelsomino americano.	<i>alba</i> -	- Cassia poetica, Genestrello, Ginestrina dalle coccole rosse.
<i>Catappa</i> -	- Catalpa.	Elægndàcea.	
<i>syriaca</i> -	- Catalpa.	<i>Elægus</i> -	- Eleagno.
Convolvulàcea.		<i>horténsis</i> -	- Albero di Paradiso, Eleagno, Leagno, Olivagno, Olivastro straniero, Olivo boemico, Olivo di Boemia, Olivo straniero, Zenigrate.
<i>Convolvulus</i> -	- Convolvolo, Villucchio.	<i>Hippophae</i> -	- Ippofae.
<i>Cnèdium</i> -	- Convolvolo turco, Argentea, Spolpa gallina.	<i>rhamnoides</i> -	- Olivella, Olivello.
Solanàcea.		Aristolochiàcea.	
<i>Solanum</i> -	- Solano.	<i>Aristolochia</i> -	- Aristolochia.
<i>Dulcamàra</i> -	- Amara dolce, Corallini; Dulcamara, Erba vitina, Soltro legnoso, Stalloggi, Vite di Giudea, Vite salvatica.	<i>alrho</i> -	- Sifo, Pipa, Aristolochia della Virginia, Aristolochia arborea.
Lycium		Euphorbiàcea.	
<i>afrum</i> -	- Licio.	<i>Euphorbia</i> -	- Euforbia.
<i>europæum</i> -	- Spino di Palestina.	<i>Characias</i> -	- Caracia, Erba lassa, Erba esca da pesci, Esca da pesci, Tritimale.
	- Spino santo, Spino di Cristo, Spino da crocifisso, Inchiocristi, Agutoli, Corona di spine.	<i>Buxus</i> -	- Bussolo.
Labiàta.		<i>sempervirens</i> -	- Busso, Bossò, Bossolo, Bussolo verde.
<i>Satureja</i> -	- Satureja.	<i>baleàrica</i> -	- Bossolo gentile, Bossolo orientale.
<i>montàna</i> -	- Santoreggia.	<i>Stillingia</i> -	- Stillingia.
<i>Phlomis</i> -	- Flomide.	<i>sebifera</i> -	- Albero del sego.
<i>fruticosa</i> -	- Salvia salvatica, Verbena allvestre.	Urticàcea.	
<i>Rosmarinus</i> -	- Rosmarino.	<i>Ficus</i> -	- Fico.
<i>officinàlis</i> -	- Rosmerino, Rosmarino, Rosmarino coronario, Tremarino.	<i>Càrica</i> -	- Fico.
<i>Lavàndula</i> -	- Lavanda.	<i>Morus</i> -	- Moro.
<i>Spica</i> -	- Lavanda, Lavandula, Lavandula, Spigo.	<i>alba</i> -	- Gelsò, Gelsò moro, Moro bianco, Moro gelsò.
<i>Salvia</i> -	- Salvia.	<i>laciniatà</i> -	- Moro morajalo.
<i>officinàlis</i> -	- Salvia, Salvia comune, Salvia da uccelli, Salvia domestica, Salvia maggiore, Salvia nostrale.	<i>nlgra</i> -	- Moro nere, Moro, Moro nero.
Verbènàcea.		<i>Broussonetia</i> -	- Brussonesia.
<i>Callicàrpa</i> -	- Callicarpa.	<i>papyrifera</i> -	- Moro della Cina, Moro papiro.
<i>americàna</i> -	- Callicarpa.	<i>Macclura aurantacha</i> -	- Brasletto giallo?, Sandalo giallo?
<i>Aloftia</i> -	- Aloisia.	Ulmàcea.	
<i>atriodora</i> -	- Cedrina, Aloisia, Erba cedrina, Erba cedroia, Cedroia.	<i>Ulmus</i> -	- Olmo.
<i>Vitex</i> -	- Vitice.	<i>campèstris</i> -	- Olmo, Olmo piramidale.
<i>Agnus castus</i> -	- Agno casto, Pepe de' monaci, Vitice.	<i>Celtis</i> -	- Celto.
Chenopodiàcea.		<i>austràlis</i> -	- Arcidiavolo, Bagatto, Bagolaro, Bagolearo, Bucerata, Fra giraco, Fra giracolo, Fraggiacolo, Frassignuolo, Giracolo, Giragolo, Legno da Racchette, Loto, Perlaro.
<i>Salsola</i> -	- Salsola.	Juglandàcea.	
<i>oppositifolia</i> -	- Vermicolare legnosa.	<i>Juglans</i> -	- Noce.
<i>vermiculata</i> Sp.	- Vermollina.	<i>nlgra</i> -	- Noce d'India, Noce di San Cristofano, Noce nera.
<i>Pl. 323.</i>		<i>regia</i> -	- Noce.
<i>Chenopodium</i> -	- Chenopodio.	Salicàcea.	
<i>fruticèum</i> -	- Sopravvivo legnoso.	<i>Salix</i> -	- Salcio.
<i>Salicornia</i> -	- Salicornia.		
<i>fruticosa</i> -	- Erba kali, Salicornia.		
<i>Atriplex</i> -	- Atriplice.		
<i>Hàlimus</i> -	- Alimo, Disciplina fratrum, Malocchia, Porcellana marina.		
<i>portulacoides</i> -	- Disciplina fratrum, Porcellana marina.		

Systematic Names.	Italian Names.	Systematic Names.	Italian Names.
<i>S. álba</i>	- Salcio, Salcio albero, Salcio da pali, Salcio Lombardo, Salcio perticale, Salicastro, Salcio da pertiche, Salicone, Saligastro, Vetricone.	<i>C. A. sylvéstris máxima</i>	- Bajucóle, Noccióle lunga.
<i>amygdáilina</i>	- Salcio duro da far ceste, Vinchi.	<i>Cárpinus</i>	- Noccióle tonde.
<i>babylónica</i>	- Salcio che piove, Salcio Davideo, Salcio di Babilonia, Salcio orientale, Salcio pendente, Salcio piangente.	<i>Bétulus orientális</i>	- Carpino.
<i>frágilis</i>	- Salcio fragile, Salcio gentile, Salcio San Giovanni diaciato.	<i>O'stria</i>	- Carpino, Carpino bianco.
<i>Hélix</i>	- Vinchi da far panieri, Vinco da far panieri, Salcio rosso.	<i>vulgáris</i>	- Carpino, Carpino, Ostria.
<i>pentáandra ripária</i>	- Salicone, Vetrica di Bisanzio.		
<i>viminális</i>	- Salcio nero.	<i>Platanácea.</i>	
<i>vitellina</i>	- Vetrica, Vetrica panierina, Vincino, Vinco, Vitrice.	<i>Pístanus occidentális</i>	- Platano.
<i>Pópulus álba</i>	- Salcio, Salcio da legare, Salcio giallo, Salcio greco, Salcio San Giovanni.	<i>orientális</i>	- Platano.
<i>balsamífera nigra</i>	- Pioppo.	<i>Balsamácea.</i>	
<i>fastigiáta</i>	- Gattero, Gattice, Gatto, Pioppo bianco, Popolo bianco, Albarello, Arberello.	<i>Liquidámbar</i>	- Liquidambar.
<i>trémula</i>	- Albero del balsamo.	<i>Styracéina</i>	- Storaice líquida.
<i>anguláta</i>	- Albero, Albero, Pioppa, Pioppo, Pioppo nero, Popolo nero, Opplio, Opplio da pali, Pioppo cipressino, Pioppo tiberino, Pioppo piramidale.	<i>Myricécea.</i>	
	- Albero, Alberella, Popolo Libico, Popolo montano, Tremula, Tremola.	<i>Myrica cerífera</i>	- Mirica.
	- Pioppo angoloso o angolato.	<i>Gnetácecea.</i>	
		<i>Ephedra distácha</i>	- Efedra.
<i>Betulácea.</i>		<i>Taxácea.</i>	
<i>Alnus</i>	- Alno.	<i>Táxus baccáta</i>	- Tasso.
<i>glutinosa</i>	- Ontano, Lontano, Alno.		- Albero della morte, Libo, Nasso, Tasso, Tasso mortifera, Tossico.
<i>Bétula álba</i>	- Betula.	<i>Salisbúria adiantifólia</i>	- Salisburia.
<i>lénta</i>	- Betula, Beola, Bettoia, Betula, Bedollo, Bidollo, Biola.		- Albero adianto o di quercetta scendi.
<i>papyrácea nigra</i>	- Betula della Virginia, Betula a foglie di visciolo.	<i>Pinácea, § Abietína.</i>	
	- Betula da carta.	<i>Pinus</i>	- Pino.
	- Betula da canoa.	<i>Cembra</i>	- Pino Zimbro.
<i>Corylácea, or Cupulífera.</i>		<i>Laricio</i>	- Pinastro, Pino chiappino, Pino marino, Pino salvatico.
<i>Quercus</i>	- Quercia.	<i>marítima</i>	- Pinastro, Pino chiappino, Pino marino, Pino salvatico.
<i>Egilops</i>	- Vallonca, Gallonca.	<i>Mághus</i>	- Mugli.
<i>Bállea</i>	- Ghianda castagnola di Spagna.	<i>Pinea</i>	- Pino, Pino da Pinocchi, Pino domestico, Pino gentile.
<i>Cérris</i>	- Cerro, Ghianda amare.	<i>Pinea tarentina</i>	- Pino staccia mano, Pino pemic.
<i>Flex</i>	- Elice, Leccio, Delcia.	<i>Stróbus</i>	- Pino di Lord Weymouth.
<i>Pseudó-Süber pedunculáta</i>	- Cerro sughero, Sugherelle.	<i>sylvéstris</i>	- Pino chiappino, Pino montano, Pino salvatico.
	- Eschio, Fargna, Fargno, Farnia, Ischia, Ischio, Querce, Quercia, Querce di Borgogna, Quercia gentile.	<i>Tánda</i>	- Teda, Pino rigido.
<i>sessilífibra</i>	- La piccola pianta chiamasi Querciole, e l'adulta Rovero, Rovero, Querce, Querce comune, Quercia.	<i>halapénsis</i>	- Pino d' Aleppo, Pino di Gerusalemme.
<i>Süber</i>	- Sovero, Sughera, Sughero, Sovaro.	<i>Abies balsámea</i>	- Abete.
<i>rotundifólia</i>	- Ghianda castagnola, Ghianda dolce, Querce castagnola.		- Pino balsamico, Pino di Virginia, Abete ad odore di balsamo del Gilead, Albero del balsamo del Canadà, Resina di Barbados.
<i>coccífera tinctoria</i>	- Querce del Kerme.	<i>canadénsis</i>	- Abetello della Nuova Inghilterra, Pino del Canadà.
<i>Fígu</i>	- Faggio.	<i>communis</i>	- Abete, Abete argentino, Abete bianco, Abete maschio, Abizzo, Avezzo, Pino bianco.
<i>sylvática</i>	- Faggio.	<i>álba</i>	- Abetina bianca, Abete americano, Fesso bianco, Abete bianco.
<i>Castánea véscá</i>	- Castagno.	<i>nigra</i>	- Abetina nera, Abete birra, Abete doppio, Fesso nera.
	- Castagno, Castagno domestico, Marrone.	<i>rúbra</i>	- Abetina rossa.
<i>vésca sylvéstris</i>	- Castagno salvatico, Falina, Brice.	<i>excélsa</i>	- Pezzo, Abete di Germania, Abete di Norvegia, Picea, Piatta, Pino nero, Zampina.
<i>Córylus</i>	- Nocciolo.	<i>Lárix europáa</i>	- Larice.
<i>Avellána</i>	- Avellano, Noce barbata, Noce pontica, Nocetta, Nocciuola, Nocciuolo.	<i>Larice</i>	- Larice.
		<i>Cédrus Libáni</i>	- Cedro.
		<i>Libáni</i>	- Cedro, Cedro del Libano.
		<i>Dámara orientális</i>	- Abete d' Amboina.
		<i>Pinácea, § Cuprésina.</i>	
		<i>Thúja orientális</i>	- Tuja.
		<i>orientális</i>	- Tuja, Tuja.
		<i>Cuprésus</i>	- Cipresso.
		<i>Arcepsus sempervirens pyramidális</i>	- Cipresso, Cipresso, Cipresso maschio.

Systematic Names.	Italian Names.	Systematic Names.	Italian Names.
<i>C. sempervirens</i> horizontalis	Cipressa, Cipresso femmina.		cerbone, Rogo cervino, Rogo cervino, Rogo cervino, Smilace.
<i>Schubertia</i> (Taxodiaceae) disticha	Cipresso gaggia.	<i>S. China</i>	Cina, Cina gentile, Cina petri- ta, Radice di Cina.
<i>Juniperus</i> communis	- Ginepro. - Ginebro, Ginepro, Ginepro nero, Zinepro.	<i>Sarsaparilla</i>	- Salsaparilla, Sarsaparilla, Zarsaparilla, Zarsaparilla.
<i>Oxycedrus phoenicea</i>	- Cedro Fenicio, Ginepro rosso.	<i>Ruscus aculeatus</i>	- Rusco. - Brusco, Bruscolo, Pugn topo, Pungitopo, Ruschio, Sprunaggio, Sprunaggiolo, Strinotopo.
<i>Sabina</i>	- Cedro Licio. - Sabina, Savina, Pianta dannata, Cipresso dei Magli.	<i>Hypoglossum racemosum</i>	- Balingua, Bonifaccia, Lauro Alessandrino, Lingua pagana, Lingua - Lauro Alessandrino, Lauro d' Alessandria, Lauro Ideo.
<i>virginiana</i>	- Ginepro di Virginia.		
<i>Smilacæ.</i>			
<i>Smilax aspera</i>	- Smilace. - Edera, Rogo acerbone, Rogo		

APPENDIX III.

PRICED CATALOGUES OF TREES AND SHRUBS, CONTRIBUTED BY BRITISH AND CONTINENTAL NURSERYMEN.

THE prices of trees and shrubs vary permanently in different countries from permanent causes, and also locally and temporarily, in every particular country, from difficulty or facility of cultivation, or from scarcity or abundance. The prices in London, Bollwyler, and New York, as given in the body of this work, after each of the principal species described in it, will convey a sufficiently accurate idea of the comparative prices of ligneous plants in both hemispheres. Nevertheless, we have thought it advisable to publish the following five Catalogues, as well to show the variation in prices in different parts of Europe, as to exhibit a list of names of species and varieties which existed in the year 1838 in British and Continental nurseries.

How far the plants to which these names are applied in the nurseries, are identical with those to which they are applied in this *Arboretum*, it is impossible for us, in many cases, to say. The reader can only ascertain this by examining the living plants, and comparing them with our descriptions and figures. The greater number of the names in these Catalogues, however, are, we think, correct; though, in the case of some of the genera, such as *Cratægus*, *Quercus*, *Pinus*, &c., this is not likely to be the case with all of the species; and in other genera, such as *Salix*, *Rosa*, *Cytisus*, *Genista*, *Spiræa*, *Cistus*, *Helianthemum*, &c., it cannot be expected that the nurserymen's names should be correct, since scarcely any two botanists are agreed respecting them: nor is correctness in the names of all the species and varieties of some of these genera of much consequence in a practical point of view, provided the more striking kinds are known and propagated. A great improvement in the nomenclature of hardy fruits has been made in British nurseries, by reference to the collection in the Horticultural Society's Garden; and especially by country nurserymen obtaining grafts from the Society, with the names adopted in the Society's *Fruit Catalogue* attached. Till lately, the same attention was not paid to ornamental trees and shrubs that has, ever since the Society possessed a garden, been paid to fruit trees; but a reformation in this department is now going forward, and, if London nurserymen were to compare their plants and names with the names and plants in the Horticultural Society's Garden, they might be enabled to render their catalogues of them as perfect, and their plants as true to their names, as is now the case with their catalogues and plants of fruit trees. Country nurserymen generally come to London once a year, and, by bringing specimens of their trees and shrubs with them, they might ascertain the correct names by comparing them with the living plants in the Chiswick Garden. As cuttings for propagation, or to be used as botanical specimens for determining the kinds, will, probably, in a short time be spared from the Horticultural Society's Garden, country nurserymen, Fellows of the Society, might

correct their nomenclature by sending for these. One great use of the *Arboretum et Fruticetum Britannicum* will be, to render the employers of nurserymen, and especially botanical amateurs and ladies, familiar with the correct names of ligneous plants. This will soon create among commercial gardeners a demand for a correct nomenclature, which the nurseryman will supply when he finds it his interest to do so, but not before.

In the following Catalogues, with one exception, no authorities for the names have been given by the nurserymen who sent them. The practice of affixing the authorities is adopted by all the first nurserymen on the Continent, but is almost always neglected in this country. These Catalogues were prepared before the severe frost of January, 1838, which destroyed many thousands of ligneous plants in British nurseries, and which will probably occasion a temporary rise of price in various articles for a year or two.

I.

Catalogue of American and other Tree and Shrub Seeds, imported, or procured, for Sale, by GEORGE CHARLWOOD, 14, Tavistock Row, Covent Garden.

		s. d.			s. d.			s. d.		
<i>Acacia</i>			<i>Azalea</i>			<i>Chionanthus</i>				
<i>Julibrissis</i>	per ounce	3 0	<i>dehata</i>	}	packet 1 8	<i>virginica</i>	packet	1 0		
<i>dealbata</i>		2 6	<i>viscosa</i>				<i>Chamaerops</i>			
<i>Acer</i>			<i>Baccharis</i>			<i>Palmetto</i>		1 0		
<i>rubrum</i>	}	quart 4 0	<i>integrifolia</i>	}	packet 0 6	<i>Clèthra</i>				
<i>nigrum</i>						<i>sessilifolia</i>		<i>alnifolia</i>	ounce	1 0
<i>striatum</i>						<i>Bupleurum</i>		<i>acuminata</i>		
<i>Negundo</i>			<i>frutescens</i>			<i>paniculata</i>				
<i>montanum</i>		2 0	<i>Baptisia</i>			<i>tomentosa</i>				
<i>sacharinum</i>		5 0	<i>tinctoria</i>	packet	1 0	<i>pubescens</i>				
<i>campèstre</i>	busbel	4 0	<i>Bétula</i>			<i>Cissus</i>	packet	0 6		
<i>Pesculo-Platanus</i>		5 0	<i>tinctoria</i>			<i>Aederacea</i>				
<i>monspesulanum</i>	quart	5 0	<i>lenta</i>	quart	1 0	<i>Clématis</i>				
<i>ericarpum</i>		4 0	<i>exedra</i>		1 6	<i>virginica</i>				
<i>tataricum</i>		4 0	<i>populifolia</i>		1 0	<i>Flammula</i>				
<i>craticum</i>	packet	1 0	<i>papyracea</i>		1 0	<i>Vibena</i>				
<i>platanoides</i>	busbel	7 0	<i>glandulosa</i>		1 6	<i>Viticifolia</i>	packet	1 0		
<i>rubrum</i>	quart	4 0	<i>phimila</i>		3 0	<i>campanulata</i>				
<i>Ailantus</i>			<i>nigra</i>		1 6	<i>Cornus</i>				
<i>glandulosa</i>	packet	1 0	<i>nana</i>	packet	0 6	<i>storida</i>		1 0		
<i>Alinus</i>			<i>alba</i>	busbel	4 0	<i>Corylus</i>				
<i>serrulata</i>	ounce	1 0	<i>pendula</i>		4 0	<i>Avelana barcelo-</i>	busbel	16 0		
<i>glutinosa</i>	lb.	6 0	<i>dactrica</i>	packet	1 0	<i>nensis</i>				
<i>oblongata</i>	packet	1 0	<i>carpinifolia</i>		2 0	<i>Coturna</i>	packet	1 0		
<i>incana</i>		2 0	<i>pontica</i>		2 0	<i>Crataegus</i>				
<i>cordifolia</i>		2 6	<i>fruticosa</i>		2 0	<i>pyrifolia</i>	quart	3 0		
<i>Amorpha</i>			<i>lutea</i>		2 6	<i>monogyna</i>				
<i>fruticosa</i>		1 0	<i>Bignonia</i>			<i>sibirica</i>				
<i>Ampelopsis</i>			<i>radicans</i>	ounce	2 6	<i>dentata</i>				
<i>Aederacea</i>		1 0	<i>Rumelia</i>			<i>odoratissima</i>				
<i>Andromeda</i>			<i>tycioides</i>		1 0	<i>escocaron</i>				
<i>arborea</i>	ounce	2 0	<i>Carpinus</i>			<i>glandulosa</i>				
<i>mariana</i>		1 6	<i>Bétulus</i>	quart	1 0	<i>macracantha</i>				
<i>paniculata</i>		2 0	<i>americana</i>		2 0	<i>caroliniana</i>				
<i>racemosa</i>		2 6	<i>Castanea</i>			<i>Celastrus</i>				
<i>Agustrina</i>			<i>vesca</i>	busbel	12 0	<i>cordata</i>				
<i>Apios</i>			<i>Catalpa</i>			<i>storida</i>				
<i>frutescens</i>	packet	1 0	<i>cordifolia</i>		ounce 2 0	<i>fissa</i>				
<i>Aronia</i>			<i>Ceanothus</i>			<i>linearis</i>				
<i>melanocarpon</i>			<i>americanus</i>		1 0	<i>nigra</i>	packet	1 0		
<i>Aralia</i>			<i>asureus</i>	packet	1 0	<i>Olivieriana</i>				
<i>racemosa</i>		0 6	<i>Cedrus</i>			<i>punctata</i>				
<i>Azalea,</i>			<i>Libani</i>		1 0	<i>stipulacea</i>				
<i>sine mixed</i>			<i>cones</i>	per	100 10 0	<i>Crus-galli</i>				
<i>nudiflora</i>			<i>Celastrus</i>			<i>Pyracantha</i>				
<i>glauca</i>			<i>scandens</i>	ounce	0 6	<i>prunifolia</i>				
<i>variegata</i>			<i>Cercis</i>			<i>parvifolia</i>				
<i>staminea</i>			<i>canadensis</i>			<i>pyracanthifolia</i>				
<i>nitida</i>	packet	1 0	<i>Siliquastrum</i>		1 6	<i>coccinea</i>				
<i>scabra</i>			<i>Cephalanthus</i>			<i>cordata</i>				
<i>præcox</i>			<i>occidentalis</i>	packet	1 0	<i>purpurea</i>				
<i>floribunda</i>						<i>nigra</i>				
						<i>marcescens</i>				

		s. d.			s. d.			s. d.
<i>Crataegus</i>			<i>Uva</i>			<i>Philadelphus</i>		
<i>Asarobus</i>			<i>frutescens</i>	packet 0	6	<i>inodorus</i>		packet 1 0
<i>Arbuta</i>			<i>Juglans</i>			<i>grandiflorus</i>		
<i>tanacetifolia</i>			<i>alba</i>			<i>Pinus</i>		
<i>mexicana</i>			<i>amara</i>			<i>palustris, in cones</i>	quart 1	0
<i>virginica</i>			<i>porcina</i>			<i>pauciflora</i>		3 0
<i>heterophylla</i>			<i>tomentosa</i>			<i>alba</i>		2 0
<i>corallina</i>		packet 1 0	<i>sulcata</i>		1 6	<i>variabilis</i>		1 0
<i>Cupressus</i>			<i>syriaciformis</i>		2 6	<i>inops</i>		1 0
<i>disticha</i>	quart 3	0	<i>oliviformis</i>		3 0	<i>rubra</i>		2 0
<i>shuybides</i>		4 0	<i>sciciformis</i>		1 6	<i>resinosa</i>		2 0
<i>sempervirens</i>	lb. 6	0	<i>nigra</i>		0 9	<i>serotina</i>		1 0
<i>stricta</i>		6 0	<i>cinerea</i>		0 9	<i>nigra</i>		
<i>pendula</i>	ounce 0	6	<i>Juniperus</i>			<i>canadensis</i>		quart 2 0
<i>horizontalis</i>		0 6	<i>virginiana</i>		1 6	<i>resinosa</i>		1 0
<i>Cytisus</i>			<i>Sabina</i>		packet 1 0	<i>balsamea</i>		
<i>biflorus</i>			<i>chinensis</i>		1 6	<i>Fraseri</i>		ounce 2 6
<i>capitatus</i>			<i>communis</i>		0 0	<i>nigra</i>		
<i>decumbens</i>			<i>daurica</i>		1 0	<i>pumilio</i>		1 0
<i>foliatus</i>			<i>Oxycedrus</i>			<i>montana</i>		1 0
<i>foliis incis</i>			<i>macrocarpa</i>		packet 3 0	<i>syvestris</i>		lb. 3 0
<i>myrticulus</i>		ounce 2 0	<i>phenicea</i>			<i>Pinaster</i>		4 0
<i>polytrichus</i>			<i>lycia</i>		4 0	<i>maritima</i>		2 0
<i>triflorus</i>			<i>Kalmia</i>			<i>Pinus</i>		3 0
<i>uralensis</i>			<i>latifolia</i>		ounce 2 0	<i>Strobilus</i>		2 0
<i>sesillifolius</i>			<i>glauca</i>		2 6	<i>Larix</i>		1 6
<i>alpinus</i>		quart 2 0	<i>angustifolia</i>		2 0	<i>Picea</i>		2 6
<i>Laburnum</i>			<i>Laurus</i>			<i>abies</i>		3 0
<i>Diospyros</i>			<i>Sassafras</i>			<i>alba</i>		4 0
<i>virginiana</i>		packet 1 0	<i>Benzoin</i>		quart 6 0	<i>Platanus</i>		
<i>Fagus</i>			<i>Lagerstrœmia</i>			<i>occidentalis</i>		quart 1 0
<i>syriatica</i>		per bushel 12 0	<i>indica</i>			<i>Polygonum</i>		
<i>Fraxinus</i>			<i>coccinea</i>			<i>virginicum</i>		1 0
<i>pubescens</i>			<i>rubra</i>			<i>Prinos</i>		
<i>epiptera</i>			<i>purpurea</i>		packet 1 0	<i>glaber</i>		3 0
<i>caroliniana</i>			<i>Lespedeza</i>			<i>Prunus</i>		
<i>sambucifolia</i>			<i>frutescens</i>			<i>hyemalis</i>		5 0
<i>juglandifolia</i>		quart 4 0	<i>Liriodendron</i>			<i>carolinensis</i>		4 0
<i>tomentosa</i>			<i>Tulipifera</i>			<i>virginica</i>		4 0
<i>platycarpa</i>			<i>integrifolia</i>		quart 1 6	<i>Ptelea</i>		
<i>acuminata</i>			<i>Magnolia</i>			<i>trifoliata</i>		packet 1 0
<i>excelsior</i>		bushel 4 0	<i>glauca</i>		ounce 1 6	<i>Pyrus</i>		
<i>Gaultheria</i>			<i>acuminata</i>		2 6	<i>arbutifolia</i>		quart 5 0
<i>procumbens</i>			<i>longifolia</i>		1 6	<i>Quercus</i>		
<i>Celastrum</i>		packet 1 0	<i>macrophylla</i>		5 0	<i>pedunculata</i>		bushel 5 0
<i>nitidum</i>			<i>tripetala</i>		2 6	<i>sessiliflora</i>		7 6
<i>sempervirens</i>			<i>Melia</i>			<i>Cerris fulhamensis</i>		quart 2 6
<i>Gleditsia</i>			<i>azedarach</i>			<i>Shber</i>		3 0
<i>triacanthos</i>		lb. 4 0	<i>Menispermum</i>		packet 1 0	<i>Taxus</i>		5 0
<i>infrms</i>		5 0	<i>amilacinum</i>			<i>Evulus</i>		7 0
<i>monosperma, in pods</i>		qt. 2 0	<i>Mespilus</i>			<i>australis</i>		7 6
<i>Gordonia</i>			<i>arbutifolia</i>			<i>coccinea</i>		1 6
<i>Lantana</i>		packet 1 0	<i>Mitchella</i>			<i>alba</i>		1 0
<i>Halæia</i>			<i>repens</i>		0 6	<i>Chinquapin</i>		4 0
<i>tetraptera</i>			<i>Morus</i>			<i>tinctoria</i>		2 0
<i>parviflora</i>		quart 3 0	<i>nigra</i>			<i>macrocarpa</i>		5 0
<i>Hamamelis</i>			<i>alba</i>		ounce 0 6	<i>Prinos</i>		2 0
<i>virginica</i>		packet 1 0	<i>rubra</i>			<i>Phellos</i>		5 0
<i>Hibiscus</i>			<i>Myrica</i>			<i>obtusiloba</i>		3 0
<i>syriacus</i>		lb. 6 0	<i>cerifera</i>			<i>oliviformis</i>		5 0
<i>Hypericum</i>			<i>carolinensis</i>		quart 4 0	<i>bicolor</i>		2 0
<i>Kalmianum</i>			<i>Nyssa</i>			<i>palustris</i>		2 0
<i>prolificum</i>			<i>denticulata</i>			<i>nigra</i>		3 0
<i>ascryoides</i>		packet 0 6	<i>tomentosa</i>			<i>flex</i>		2 0
<i>canadense</i>			<i>agatica</i>			<i>Cerris</i>		1 0
<i>Rhus</i>			<i>sandicans</i>			<i>Banisteri</i>		4 0
<i>Aquifolium</i>		bushel 10 0	<i>virginica</i>			<i>Rhododendron</i>		
<i>opaca</i>		quart 4 0	<i>Ostrya</i>			<i>hirtum</i>		packet 1 0
<i>Daboia</i>		6 0	<i>virginica</i>			<i>ferrugineum</i>		1 0
<i>laxiflora</i>		4 0	<i>Olea</i>			<i>maximum</i>		ounce 3 6
<i>Cassia</i>		4 0	<i>americana</i>			<i>ponticum</i>		2 0
<i>vomitaria</i>		6 0	<i>Passiflora</i>			<i>punctatum</i>		1 0
<i>angustifolia</i>		6 0	<i>incarnata</i>			<i>Rhus</i>		
<i>Illicium</i>						<i>glabra</i>		1 6
<i>floridanum</i>		packet 1 0				<i>vernix</i>		2 0
<i>Indigofera</i>						<i>typhina</i>		
<i>caroliniana</i>		1 0				<i>elegans</i>		ounce 1 0
<i>Itea</i>						<i>copallina</i>		
<i>virginica</i>		packet 0 6						

		s. d.			s. d.			s. d.	
Robinia Pseud-Acacia			Smilax			Sabal			
American	lb. 5 0		ovata	} packet 1 0		flabelliformis	} packet 1 0		
European	2 0		hastata			Thuja			
viscosa	ounce 1 0		Walters			occidentalis	lb. 4 0		
Rosa			Spartium			Ulex			
levigata	} packet 0 6		junceum	lb. 6 0		europæa	1 0		
corymbosa			Spiræa			Vaccinium			
carolina			opulifolia	} packet 0 6		arbutreum			
suavifolia			tomentosa				resinbeum		
fraxinifolia			salicifolia				Viburnum		
fenestrina			corymbosa				dentatum	} packet 1 0	
setigera			rosea				nidum		
rubifolia			Sterculia			prunifolium			
florida			platanifolia			pyrifolium			
rubiginosa			Symphoria			Yucca			
floribunda		racemosa			filamentosa				
lucida		glomerata			flaccida				
Champneyana									
var. pallida									
indica plena									

II.

Catalogue of Forest and Ornamental Trees, American Plants, and Flowering Shrubs, with the Prices for 1838, sold by RICHARD FORREST (Successor to the late W. Malcolm and Co.), Nursery and Seedsman, Kensington.

	Per Plant. s. d.	Per 100. s.	Per 1000. s.		Per Plant. s. d.	Per 100. s.	Per 1000. s.
Acacia,				Fir,			
seedlings	—	—	15	balm of Gilead			
transplanted	—	10		seedlings, 2 years'	—	—	10
three-thorned, seedlings	—	10		transplanted	—	—	40
transplanted, 3 to 5 feet	—	25		silver, seedlings	—	—	15
Alder,				transplanted	—	—	20
seedlings, 1 year's	—	—	6	spruce, seedlings, white	—	—	2s. 6d
transplanted	—	—	15	transplanted	—	—	25
Ash,				black spruce, 2 years' seedlings	—	—	20
seedlings	—	—	7s. 6d	Scotch fir, 1 year	—	—	1s. 6d
transplanted	—	—	10	2 years	—	—	2s. 6d
mountain, seedlings, 1 year's	—	—	6	transplanted, 1 year	—	—	10
transplanted	—	—	20	2 years	—	—	20
Beech,							
seedlings, 2 years'	—	—	8	Hazel			
transplanted	—	—	40	Holly,			
purple-leaved	1 6			common	—	—	10
fern-leaved	1 6			variegated, in sorts	50	75	
Birch,				Hornbeam,			
weeping, seedlings	—	—	7s. 6d	seedlings	—	—	7s. 6d
transplanted	—	—	20	transplanted	—	—	50
Chestnut,				Laburnum,			
horse, seedlings	—	—	7	seedlings	—	—	5
two years' seedlings	—	—	10	transplanted	—	—	50
transplanted	—	—	7s. 6d	Larch,			
striped-leaved	2 6			seedlings, 1 year	—	—	2s. 6d
scarlet-flowered	1 6			2 years	—	—	2s. 6d
yellow-flowered	1 6			transplanted	—	—	10
Spanish, seedlings				Lime,			
transplanted	—	—	15	transplanted	—	—	20
striped-leaved	2 6			Maple,			
prolific	1 6			English, seedlings	—	—	10
fern-leaved	1 6			transplanted	—	—	20
Elm,				Norway	—	—	30
wych, seedlings	—	—	5	Oak,			
transplanted	—	—	15	seedlings, 2 years', strong	—	—	10
English, grafted	—	—	20	mossy-cupped seedlings	—	—	4
striped-leaved	—	—	50	transplanted	—	—	20
Dutch,	—	—	50	scarlet, seedlings	—	—	10
Cornish, or mountain	—	—	50	transplanted	—	—	15
transplanted	—	—	50	Lucombe	3 6		
Chichester	—	—	25	striped-leaved	3 6		
broad-leaved American	—	—	25	willow-leaved, bedded	—	—	25

	Per Plant. s. d.	Per 100. s.	Per 1000. s.		Per Plant. s. d.	Per 100. s.	Per 1000. s.
Oak,				Yew,			
Catesby's, bedded	1 6			seedlings, 3 years'	—	20	
willow-leaved, in pots	2 6			one foot	—	20	
white, seedlings	—	15		transplanted, 2 feet to 3 feet	10	40	
black, seedlings	—	10		broad-leaved Irish			
fern-leaved	3 6						
obtusiloba, seedlings	—	10					
grammitia, in pots	1 6						
Cerris fol. variegatis	5 0						
cork, in pots	2 6 1/2						
evergreen, seedlings, 1 year's	—		20				
in pots, 18 inches	—	100					
5 to 6 feet	3 6						
				HARDY CLIMBERS.			
Pine,				Aristolochia			
Weymouth, seedlings, 1 year's	—	—	8	alpa	1 6		
2 years'	—	—	12	tomentosa	1 6		
bedded	—	—	20	Atrage			
transplanted	—	—	50	americana	1 6		
cluster, seedlings	—	—	10	austriaca	1 6		
transplanted	—	—	25	sibirica	1 6		
in pots	—	75		Bignonia			
pinaster, seedlings, 1 year	—	—	10s 6d	radicans major	0 6		
transplanted	—	—	25	capreolata	2 6		
stone, seedlings	—	6		grandiflora	2 6		
in pots	1 6			Celastrus			
cembra	1 6			scandens	0 9		
in pots	5 0			Clématis			
maritima, seedlings	—	—	10	sweet-scented, bedded	0 9	25	
New Jersey do.	—	6		florida	1 6		
mugho, seedlings	—	—	10	simplex	1 6		
2 years'	—	—	20	pleno	1 6		
bedded	—	—	50	Viticella rubra	2 6		
laricio de Calabri	—	5		purpurea	0 9		
laricio de Corse, 2 years bedded	—	6		fl. pleno	1 6		
Aleppo,				Viterna			
seedlings	—	5		alpina	1 6		
in pots	1 0			angustifolia	1 6		
canadensis, 2 feet	0 6			cylindrica	2 6		
Plane,				erecta	1 6		
occidentalis, 3 feet to 4 feet	—	20		hispanica	1 6		
orientalis	—	30		integrifolia	1 0		
Poplar,				lathyrifolia	1 0		
black Italian	—	5		parviflora	1 0		
balsam	—	10		crispa	1 6		
white, or abele	—	25		calycina	0 9		
Carolina	—	50		cirrhaea	1 6		
new sweet-scented	—	10		montana	3 6		
Sycamore,				odorata	1 0		
seedlings	—	—	5	viornoides	1 0		
transplanted	—	—	15	glauca	1 0		
striped	—	50		orientalis	1 6		
Walnut,				Vitafba	1 6		
seedlings	—	5		reticulata	1 6		
transplanted	—	50		Decumaria			
				barbata	2 0		
				sarmentosa	2 0		
				Gelsemium			
FOR HEDGES.				sempervirens	2 6		
Berberry,				nitidum	1 6		
seedlings	—	—	8	Honeysuckle,			
transplanted	—	—	25	scarlet-trumpet	—	50	
Box,				evergreen	—	50	
dwarf, for edging	—	2		flexuosa	1 6		
tree	1 6			pubescens	2 6		
Briers,				alba	2 6		
sweet, seedlings	—	5		sava	2 6		
transplanted	—	8		quercifolia	2 6		
Crab,				variegata	2 6		
seedlings	—	—	5	Ivy,			
transplanted	—	—	10	broad-leaved, Irish	—	30	
Furze,				variegated	—	50	
seedlings	—	—	10	All the new varieties from the			
Holly,				Society.			
seedlings	—	—	6	Jasminum			
transplanted, variegated	—	100		officinale	1 0		
Privet,				fruticans	1 0		
common	—	10		revolutum	1 6		
evergreen	—	16		Wallichianum	2 6		
Thorn,				humile	1 6		
white, seedlings, 2 years'	—	—	5s. to	Lycium			
transplanted	—	—	7s. 6d	barbarum	0 9		
			10 15				

	Per Plant.	Per 100.	Per 1000.		Per Plant.	Per 100.	Per 1000.
	s. d.	s. d.	s. d.		s. d.	s. d.	s. d.
Menispermum				Rosa			
<i>canadense</i>	-	1 0		<i>multiflora</i>	-	0 9	
<i>virginicum</i>	-	1 0		<i>sempervirens</i>	-	0 9	
Passiflora				<i>Banksia alba</i>	-	0 9	
<i>cærbæa</i>	-	1 0		<i>lutea</i>	-	0 9	
<i>hybrida</i>	-	to		<i>Virginian silk tree</i>	-	0 6	
<i>Colvillii</i>	-	2 6		<i>Virginian creeper</i>	-	0 6	
<i>Mayana</i>	-			Wistaria			
Periploca				<i>frutescens</i>	-	1 6	
<i>græca</i>	-	0 9		<i>sinensis</i>	-	1 6	
Rosa				Zizyphus			
<i>Boursaultii</i>	-	0 9		<i>volubilis</i>	-	1 6	
				<i>sinensis</i>	-		25

ORNAMENTAL TREES, AMERICAN PLANTS, AND FLOWERING SHRUBS.

	Per Plant.				Per Plant.				Per Plant.
	s. d.	s. d.			s. d.	s. d.			s. d.
Abies				Althæa frutex,				Azalea	
<i>nlgra</i>	-	2 6	5 0	<i>seedlings</i>	-	5 0		<i>aurantia</i>	-
<i>cephalónica</i>	-	63 0	105 0	<i>bedded</i>	-	16 0		<i>major</i>	-
<i>rùbra</i>	-	0 9	1 0	<i>double purple</i>	-	50 0		<i>blush</i>	-
<i>balshama</i>	-	7 6	10 6	<i>red</i>	-	50 0		<i>calendulacea Mx.</i>	-
<i>canadensis var.</i>	-	1 0	1 6	<i>striped</i>	-	75 0	per 100	<i>canescens</i>	-
<i>Clanbrassilliana</i>	-	3 6	5 0	<i>painted lady</i>	-	50 0		<i>carnea plena</i>	-
<i>Douglasii</i>	-	25 0	40 0	Amelanchier				<i>coccinea</i>	-
<i>Douglasii taxifolia</i>	-	50 0	80 0	<i>vulgaris</i>	-	50 0		<i>early pink</i>	-
<i>Fraseri</i>	-	2 6	5 0	<i>Botryapium</i>	-	50 0		<i>red</i>	-
<i>Smithiana</i>	-	10 6	15 0	Amorpha				<i>fasciculata</i>	-
<i>Picta</i>	-	2 6	5 0	<i>fruticosa L.</i>	-	1 0		<i>fragrans</i>	-
<i>sibirica</i>	-	2 6	5 0	Amygdalus				<i>glauca Lam.</i>	-
<i>excelsa stricta</i>	-	3 6	5 0	<i>macrocarpa</i>	-	2 6		<i>hirta</i>	-
<i>Menziesii</i>	-	63 0	100 0	<i>orientalis W.</i>	-	2 0		<i>hipida</i>	-
Acacia				Andrómæda				<i>late purple</i>	-
<i>Julibrissin</i>	-	1 6		<i>arbores W.</i>	-	7 6		<i>Leopold</i>	-
Acer				<i>casinifolia</i>	-	1 6		<i>nitida PA.</i>	-
<i>coccineum</i>	-	1 6		<i>Catesbeii W.</i>	-	1 6		<i>nudiflora L.</i>	-
<i>eriocarpum</i>	-	1 6		<i>mariana W.</i>	-	2 6		<i>pontica alba L.</i>	-
<i>heterophyllum</i>	-	1 6		<i>paniculata</i>	-	1 6		<i>procumbens</i>	-
<i>hybridum</i>	-	1 6		<i>pulverulenta</i>	-	1 6		<i>semiplena</i>	-
<i>Lobellii</i>	-	2 6		<i>speciosa PA.</i>	-	2 6		<i>serotina</i>	-
<i>macrophyllum</i>	-	1 6		<i>speciosa var.</i>	-	21 0		<i>speciosa major</i>	-
<i>nlgrum</i>	-	1 6		<i>frorbunda, and many</i>	-	21 0		<i>viscosa L.</i>	-
<i>platanioides L.</i>	-	1 6		<i>other fine varieties</i>	-			<i>vericolor</i>	-
<i>saccharinum L.</i>	-	2 6		Anona				<i>Waterer's red</i>	-
<i>Many other sorts.</i>	-			<i>triflora</i>	-	1 6		<i>Ohent azaleas, fine</i>	-
Æsculus				Aralia				<i>sorts; and other</i>	-
<i>macrostachya</i>	-	1 6		<i>spindsa</i>	-	2 6		<i>hybrid varieties</i>	-
<i>coccinea</i>	-	2 6		<i>racemosa</i>	-	1 6		Bay,	
<i>flava W.</i>	-	2 6		Arbor Vitæ,				<i>sweet</i>	-
<i>Pavia</i>	-	2 6		<i>American</i>	-	0 9		<i>narrow-leaved</i>	-
<i>Hippocastanum</i>	-	2 6		<i>Oriental, seedlings</i>	-	1 0		Benthámia	
<i>fol. argenteis</i>	-	2 6		<i>transplanted</i>	-	10 0	per 100	<i>fragifera</i>	-
<i>pubescens</i>	-	2 6		<i>Chinese</i>	-	5 0		Berberis	
<i>rubra</i>	-	2 6		Arbutus,				<i>Aquifolium</i>	-
<i>rubicunda Dec.</i>	-	2 6		<i>seedlings</i>	-	7 6	per 100	<i>repens</i>	-
Ailántus				<i>transplanted</i>	-	21 0		<i>fascicularis</i>	-
<i>glandulosa W.</i>	-	1 0		<i>scarlet</i>	-	3 6		<i>dealbata</i>	-
Alaternus				<i>Andrachne W.</i>	-	3 6		<i>aristata Dec.</i>	-
<i>common</i>	-	0 9		<i>U'nedo</i>	-	2 6		<i>asiatica Ros.</i>	-
<i>blotched-leaved</i>	-	0 9		<i>mucronata L. fil.</i>	-	3 6		<i>Many other interest-</i>	-
<i>silver-striped</i>	-	2 6		<i>crispa</i>	-	3 6		<i>ing species and var.</i>	-
<i>gold-striped</i>	-	2 6		<i>serratifolia</i>	-	3 6		Box, Tree,	
Almond,				<i>procera Des.</i>	-	5 0		<i>green</i>	-
<i>single dwarf</i>	-	1 6		Arctostáphylos				<i>variegated</i>	-
<i>double</i>	-	1 6		<i>alpina</i>	-	5 0		Broom,	
<i>Japan</i>	-	1 6		<i>U'va-ursi</i>	-	3 6		<i>Spanish, seedlings</i>	-
A'lnus				A'ucuba				<i>transplanted</i>	-
<i>cordata</i>	-	1 6		<i>japónica L.</i>	-	1 0	2 6	<i>double</i>	-
<i>laciniata</i>	-	1 6		Azalea				<i>white Portugal.</i>	-
<i>Many other interest-</i>	-			<i>arborescens</i>	-	5 0		<i>seedlings</i>	-
<i>ing varieties.</i>	-			<i>autumnalis</i>	-	21 0	per doz.	<i>bedded</i>	-

		Per Plant.				Per Plant.				Per Plant.					
		s.	d.	s.	d.	s.	d.	s.	d.	s.	d.				
Garrya															
elliptica D. Don	3	—	6												
Gaultheria															
procumbens W.	1	0													
Shallon Ph.	1	6—	2	6											
Genista															
anglica	1	6													
decumbens	1	6—	2	6											
scariosa	1	6													
sericea	1	6													
tincubria L.	1	6													
triquetra	1	6													
Many other species															
Gleditsia															
horrida W.	2	0													
sinensis P. S.	1	0													
macracantha L. C.	1	0													
inermis	1	6													
latifolia	1	0													
Gordonia															
pubescens W.	3	6													
Lasianthus	3	6—	5	0											
Gymnocladus															
canadensis W.	1	6													
Halësia															
tetraptera W.	1	0													
diptera	2	6													
Hazel															
purple-leaved	}	2	6												
cut-leaved															
Hedera															
poëtica (yellow-berried)	2	6													
Hippophaë															
conferta	1	6													
rhamnoides	0	9—	1	0											
Hydrangea															
arborescens L.	1	6													
hortensis Ssa.	1	6													
quercifolia Bart.	3	6													
Ilex															
Aquifolium variegatum	1	6—	2	6											
axox															
fol. argenteis	}	1	6—	2	6										
fol. atreia															
fructu læteo heterophyllum															
Many other varieties.															
Itea															
virginica	1	0													
Judas tree															
seedlings	5	0	per	100											
bedded	0	6													
transplanted	1	0													
Juniper															
common, seedlings	5	0	per	100											
transplanted	0	6													
Swedish	0	6													
Irish	0	9													
Sabina	1	6													
variegated	1	6													
Kalmia															
latifolia	1	0—	5	0											
angustifolia	1	0													
glauca	1	6													
rubra	1	6													
variegata	1	0													
pumila	1	0													
nitida	1	6													
Kælerutéria															
paniculata Dec.	0	9—	1	6											
Laburnum															
English	}	1	0—	1	6										
Scotch															
oak-leaved	3	6													
purple	2	6—	3	6											
weeping	0	9—	1	6											
Laburnum															
Waterer's new	15	0—	21	0											
new scarlet	5	0—	7	6											
Larix															
europæa Dec.	}	0	9—	1	0										
var. pendula															
microcarpa															
pendula Lamh.															
sibirica	5	0—	7	6											
Laurel, Portugal															
seedlings	5	0	per	100											
transplanted	8	0													
Laurus															
Benzoin L.	1	6													
Sassafras L.	2	6—	5	0											
Laurustinus															
common (pots)	2	6													
shining-leaved	1	6—	2	6											
variegated	1	6—	2	6											
Lêdum															
palustre, W.	}	1	0—	1	6										
latifolium W.															
angustifolium															
thymifolium															
decumbens															
duxifolium W.	2	6													
Ligustrum															
chinense	1	0—	1	6											
Linnaea															
borealis Gra.	0	9—	1	0											
Liquidambar															
Styraciflua W.	1	6—	2	6											
imberbe	1	6—	2	6											
Liriodendron															
Tulipifera W.	}	1	6—												
transplanted															
Lycium															
barbarum	0	9													
chinense	0	9													
Maclura															
aurantica Nut.	1	0—	2	6											
Magnolia															
acuminata W.	3	6—	5	0											
auriculata W.	5	0—	10	6											
conspicua H. K.	5	0—	7	6											
cordata Ph.	5	0													
fine Exmouth (pots)	3	6—	5	0											
glauca	1	6—	2	6											
gracilis	3	6—	5	0											
grandiflora W.	3	6—	5	0											
macrophylla Ph.	10	6—	15	0											
obovata	1	6													
Soulangiana	5	0—	7	6											
Thomsoniana	5	0—	7	6											
tripetala W.	2	6—	7	6											
purpurea B. M.	5	0													
Menziesia															
polifolia J.	0	9—	1	0											
globularis Sal.	1	0—	2	6											
pumila	1	0—	1	6											
cerulea Wahl.	3	6—	5	0											
Mespilus															
Amelanchier	}	1	6—	2	6										
antartica															
arbutifolia															
Botryapium															
racemosa															
capitata															
Chamaemespilus															
floribunda															
germanica															
latifolia															
alpe nheleo															
grandiflora															
ovata															
pumila															
Pyracantha															
sanguinea															
Mulberry															
white	}	seedlings	5	0	per	100									
black															
Myrtle, Candle-															
berry	5	0													
bedded	.36	0													
Nyssa															
aquatica	.0	9—	1	6											

	Per Plant.	
	s. d.	s. d.
Prunus		
copallina	1	6
cerasifera	1	6
serrulata (double)		
sibirica		
And other interesting varieties.		
Pyrus		
alpina	1	6—2 6
arbutifolia	1	6—2 6
domestica	2	6
floribunda	1	6
hybrida	1	6
semi-double	1	6
variolosa (Nepal)	1	6
vestita (Nepal)		
Many other species.		
Rhamnus		
latifolia	1	0—1 6
alnifolia	1	0—1 6
alpinus	1	6—2 6
Rhododendron		
alta-cerense	21	0
anthopogon		
arbutum (Nepal)	7	6—10 6
Smak		
aucubifolia	7	6
azaleoides Hort.	2	6
odoratum	5	0
campanulatum	21	0—63 0
catawbiense	2	6
caucasicum W.	3	6—10 6
caucasicoides	5	0
Chamaecistus W.	5	0—10 6
dalricum W.	2	6
atrovirens	2	6
ferrugineum W.	1	0—1 6
Glennydunum		
guttatum		
gold-blotched	3	6
striped		
hirsutum W.	1	6
fol. var.		
striped-leaved		
hybridum	2	6
hybridum enneadrum		
lapponicum Wabl.	7	6—10 6
macranthum	7	6—10 6
magnoliafolium	3	6—0 6
maximum W.	1	6—2 0
roseum	3	6
myrtifolium Led.	3	6—5 0
nivaticum	7	6—10 6
niveum	10	6
Nobleianum	10	6—42 0
odoratum Hort.	5	0—7 6
pictum		
ponicum in var. W.	1	0—2 6
glomeratum	2	6
album (true)	3	6
princeps		
prunifolium		
pumilum	3	6
punctatum W.	2	6—3 6
Russellianum	15	0—21 0
silver-striped	5	0
Waterianum	21	0
With all the new and interesting Hybrids.		
Rhodora		
canadensis	2	0
Rhus		
aromatica H. K.	2	0
canadensis		
copallina	1	6
major		
Coriaria		
Cotinus L.	1	0

	Per Plant.	
	s. d.	s. d.
Rhus		
elegans W.	1	6
glabra L.	1	0
leucantha	1	6
radicans L.	1	0
suavicolens	1	6
Toxicodendron L.	1	0
trifoliata	1	6
typhina L.	1	0
erecta	1	0
vernix L.	1	6
chinensis	1	6
viridiflora	1	6
Ribes		
adreum praecox	1	6
serotinum	0	9
sanguineum	0	9
yellow-fruited	1	0
ebrium	2	6
echinatum	2	6
glutiniosum Dougl.	2	6
inebrians	3	6
malvaceum	5	0
multiflorum	3	6
niveum	3	6
punctatum	3	6
sanguineum (dark var.)	1	6—3 6
saxatile		
spectiosum Lindl., Dec.		
Robinia		
hispida W.	1	6—2 6
glutinosa	1	6
inermis	1	6
arenaria	1	6—2 6
Hamodendron	1	6—2 6
Chamaeops	1	6
pygmaea	1	6
jubata	21	0
macrophylla	1	0
tortuosa	2	6
spectabilis	1	6
Roses		
common moss	0	6
white moss	3	6—5 0
blush moss	2	6
crimson moss	3	6
celestial	0	9
village maid, Stand.	5	0
Collection of Dwarf Roses, 30s. per 100.		
standard, in fine collection	5	0—7 6
China, ditto	5	0—7 6
Scotch, double	5	0—7 6
A collection of 300 different sorts		
Rubus		
virginicus	1	0
double white	1	0
cut-leaved	1	0
strictus E. B.	2	6
pauciflorus	1	0
spectabilis	1	6—2 6
nootkanus Moc.	1	6
Ruscus		
aculeatus L.	0	6—0 9
Hypoglössum L.	1	6
racemosus L.	1	6
Salisbùria		
adiantifolia Sm.	1	0—1 6
Sambucus		
laciniata	1	0—1 6
variegata alba	1	0—1 6
fol. adreis		
fructu-albo	1	0—1 6

	Per Plant.	
	s. d.	s. d.
Smilax		
aspera	1	6
Sorapavilla	1	6
Solanum		
crispum	1	0
Sophora		
japonica W.	1	6
pendula	3	6—5 0
variegata		
Spartium		
Juncum L.	0	6
fl. pleno	1	6
argenteum	1	0
Spiraea		
argentea	3	6
aristifolia Sm.	2	6
bella Sims.	0	9
flexuosa Fis.	1	0
laevigata W.	0	9
obovata	2	6
tomentosa	1	6
Stuartia		
Malacodendron	2	6—3 6
virginica	2	6—3 6
Symphoria		
racemosa	0	6
Syringa		
perica	0	6
alba	0	6
Joakimsa		
Tamarix		
gallica	0	6
germanica	0	6
Taxus		
baccata variegata	1	6
hibernica	1	0—2
Thermopsis		
taburnifolia	2	6
Tilia		
alba (Hort. Soc.)	1	6
aurea		
laxiflora		
laciniata		
rubra		
Tulip Tree,		
seedlings	12	0 per 100
transplanted	0	9—1 0
Vaccinium		
Myrtillus		
Vitis idæa		
macrocarpon		
Oxydoccus		
hispidulum	1	0—5 0
amosum		
crassifolium		
fructum		
frondosum		
hexifolium		
virgatum		
orbiculatum		
ovatum	5	0—10 6
Vella		
Pseudo-Cytisus	1	6
Viburnum		
chinense	1	6—2 6
cotiniifolium (Nepal)	2	6
lantanoïdes	1	0
Xanthorhiza		
opifolia	1	0
Xanthoxylum		
fraxincum	1	6
Select Collection of Dahlias and Heartsease.		

III.

List of Trees, Plants, &c., with the Prices for 1838, sold by PETER LAWSON and SON, 3. Hunter Square, Edinburgh, Seedsmen and Nurserymen to the Highland and Agricultural Society of Scotland.

SEEDLING FOREST TREES.

	Per 1000.	Per 1000.
	s. d.	s. d.
Alder,		
2 year	5 0	
Ash,		
2 year	4 0	
mountain, 1 year	6 0	
Beech,		
1 year	3 6	
Birch,		
weeping, 2 year	7 6	
Chestnut,		
Spanish, 1 year	10 0	
2 year	12 6	
Hazel,		
1 year	10 0	
Holly,		
1 year	6 0	
Hornbeam,		
1 year	5 0	
Laburnum,		
English, 1 year	4 0	
Scotch, 1 year	4 0	
Maple,		
Norway, 2 year	20 0	
Oak,		
common, 2 year	3 0	
3 year	4 0	
Turkey, 1 year	7 6	
2 year	9 0	
Pinus		
austraca P. H&es (Black Pine of Austria)		
1 year	10 0	
2 year	20 0	
maritima Hort., 1 year	10 0	
2 year	12 6	
major, 1 year	12 6	
Pinaster W., 1 year		4 0
2 year		10 6
pumilio W., 1 year		15 0
pyren&ica Capt. S. E. Cook, 1 year		35 0
sylv&stris W. (Scotch Fir), from seed collected from natural-grown trees in the Highlands, 1 year		1 6
2 year		2 0
seed from Hagenau Forests, 1 year		2 0
L&rix Sal.		
europ&a Desv. (Larch), seed from the Tyrol, 1 year		3 0
2 year		4 0
common, 1 year		2 6
2 year		3 6
Abies Sal.		
Picea W. (Silver Fir), 1 year		3 0
2 year		6 0
3 year		7 6
exc&sis Poir. (Norway Spruce), 2 year		3 0
3 year		4 0
Sycamore (or Plane),		
1 year		4 0
2 year		5 0
Service,		
1 year		10 0
Thorns (or Quicks),		
1 year		2 6
Sweetbriar,		
1 year		4 0
2 year		6 0
Yews,		
2 year		20 0
Walnut,		
1 year		40 0

TRANSPLANTED FOREST TREES.

	Per 1000.	Per 1000.
	s. d.	s. d.
Alder,		
1 to 1½ foot	15 0	
Ash,		
4 to 9 inches	8 0	
1½ to 2 feet	15 0	
Beech,		
1 to 1½ foot	20 0	
2 to 2½ feet	25 0	
Birch,		
1 to 1½ foot	15 0	
Weeping, 1 to 1½ foot	20 0	
Chestnut,		
Spanish, 1 to 1½ foot	20 0	
Horn, 1 foot	15 0	
Elm (Wych)		
1 to 1½ foot	15 0	
2½ to 3 feet	20 0	
3 to 4 feet	25 0	
Hazel,		
1½ to 2 feet	25 0	
Holly,		
4 to 6 inches	20 0	
9 to 12 inches	30 0	
Laburnum,		
1½ to 2 feet	25 0	
Maple,		
English, 1½ to 2 feet	20 0	
Norway, 4 to 6 inches	30 0	
Oak,		
common, 1 to 1½ foot	17 6	
2 to 2½ feet	25 0	
3 to 4 feet	35 0	
Turkey, 1 to 1½ foot	20 0	
2 feet	30 0	
Pinus		
austraca P. H&es (Black Fir of Austria),		
4 inches	20 0	
maritima Hort., 6 inches	25 0	
Pinaster W., 4 to 6 inches	20 0	
sylv&stris W. (Scotch Fir, native), 1 to 1½ ft.	7 6	
common 1 to 1½ foot	6 0	
L&rix Sal.		
europ&a Desv. (Larch Tyrolense), 1 to 1½ ft.	7 6	
common, 1 to 1½ foot	6 0	
Abies Sal.		
alba P.A. (White American Spruce), 1 foot	15 0	

	Per 1000.		Per 1000
<i>nigra</i> Pa. (Black ditto) 1 to 1½ feet, per 100	7 6	Mountain Ash,	
<i>excelsa</i> Poir. (Norway Spruce), 6 to 8 inches	7 6	1 to 1½ foot, per 100	2 6
	15 0	4 to 5 feet, do.	5 0
<i>Picea W.</i> (Silver Fir), 6 to 9 inches	15 0	Poplar,	
Sycamore (or Plane),		alsie, 2½ to 3½ feet, per 100	10 6
1 to 1½ foot	12 6	Black Italian, 2½ to 3 feet	30 0
2 to 2½ feet	15 0	Lombardy, 2½ to 3 feet	30 0
3 to 3½ feet	20 0	Ontario, 2½ to 3 feet	30 0
Berberry,		Willows,	
1½ to 2 feet	25 0	Bedford, 2½ to 3 feet	20 0
Evergreen Privet,		Huntingdon, 2½ to 3 feet	20 0
1 to 1½ foot	20 0	Lime,	
2 to 2½ feet	25 0	10 to 12 feet, per 100	20 0
Sweetbriar	20 0	6 to 8 feet, ditto	15 0
Thorns,		3 to 4 feet, ditto	12
1 year transplanted	7 6	12 to 18 inches, ditto	5
2 years ditto	9 0	Selected Sorts,	
		3 to 5 feet, per 100	5 0

ORNAMENTAL TREES. (Those marked * are Evergreens.)

	Each.		Each
<i>Acer</i>		* <i>Aristotelia</i>	
<i>austriacum</i> Link's Enum., 3 feet	1 0	* <i>Macrus</i> L., 2½ to 3 feet	1 0
<i>campestre</i> L., fol. variegata, 1½ foot	0 9	fol. var., 1½ to 2 feet	1 6
<i>craticum</i> L., 1½ foot	1 0	<i>Aronia</i>	
<i>dasycarpon</i> Ehrh., 2 to 2½ feet	0 9	<i>floribunda</i> Sweet, 2½ feet	1 6
<i>monoesulatum</i> L., 2 feet	1 0	<i>Betula</i>	
<i>montanum</i> H. K., 1 foot	0 6	<i>alba</i> W., var. <i>incisa</i> Booth, 5 feet	7 6
<i>Negundo</i> L., 2 to 2½ feet	0 6	<i>excelsa</i> W., 1½ foot	1 0
var. <i>crispum</i> , 1½ feet	0 9	<i>fruticosa</i> W., 3 feet	1 0
<i>Opalus</i> H. K., 2½ to 3 feet	1 0	<i>lenta</i> W., 1 to 1½ foot	0 6
<i>opulifolium</i> M., 6 to 12 inches	0 4	<i>nana</i> W., 1 to 1½ foot	0 6
<i>platanoides</i> L., 2½ to 3 feet	0 4	<i>nigra</i> W., 6 feet	1 0
<i>Pseudo-Platanus</i> L., fol. var., 6 feet	0 6	<i>papyracea</i> W., 2 to 3 feet	1 0
hybridum, 3 feet	1 0	<i>populifolia</i> W., 3 feet	0 6
var. <i>Corstorphin</i> , 6 feet	1 0	<i>pubescens</i> Ehr., 3 feet	1 6
<i>rubrum</i> Ehrh., 1 to 1½ foot	0 4	<i>pumila</i> W., 1 to 1½ foot	1 0
<i>saccharinum</i> L., 2 to 2½ feet	0 6	<i>articefolia</i> Booth, 2½ to 3 feet	1 6
<i>striatum</i> Lam., 2½ feet	0 9	<i>Broussonetia</i>	
<i>tataricum</i> L., 2½ feet	0 9	<i>papyrifera</i> Ven., 2½ feet	1 6
<i>Aesculus</i>		<i>Caragana</i> L.	
<i>discolor</i> Sweet, 1½ foot	2 6	<i>Altagana</i> W., 1½ foot	0 6
<i>pumila</i> Booth, 1½ foot	1 6	<i>arborescens</i> Lam., 1½ to 2 feet	0 4
<i>rubicunda</i> Dec., 2½ to 3 feet	2 6	<i>pygmaea</i> W., 6 to 12 inches	0 6
<i>flava</i> W., 5 feet	2 0	<i>Carpinus</i>	
<i>spicata</i> Booth, 1½ to 2 feet	1 6	<i>Betulus</i> <i>incisa</i> W., 3 feet	1 6
<i>Ailanthus</i>		<i>quercifolia</i> , 3 feet	1 6
<i>glandulosa</i> W., 6 to 12 inches	0 4	fol. var., 3 feet	1 6
2 to 2½ feet	0 9	<i>Castanea</i>	
<i>Ailnus</i>		<i>pumila</i> W., 1 to 1½ foot	0 6
<i>cordifolia</i> Ten., 1 foot	1 6	<i>vesca</i> W., var. <i>lucida</i> , 5 feet	1 6
<i>glutinosa</i> W. var. <i>incisa</i> , 1½ foot	1 0	<i>aspensifolia</i> , 5 feet	2 0
quercifolia, 2 to 3 feet	1 0	<i>maculata</i> lutea, 4 to 5 feet	2 0
<i>oxyacanthifolia</i> Lo. C., 1 to 1½ foot	1 6	fol. argentea, 3 feet	2 6
<i>serrulata</i> W., 1 foot	0 6	* <i>Cedrus</i>	
<i>undulata</i> W., 3 feet	1 6	<i>Libani</i> Barrel, 1 to 1½ foot	2 6
<i>Amelanchier</i> Dec., on mountain ash stocks		1½ to 2 feet	3 6
<i>canadensis</i> L., 4 to 4½ feet	1 6	<i>Deodora</i> Rox.	
<i>grandifolia</i> Sweet	1 6	from seed, 3 to 4 inches	20 0
<i>ovata</i> Lindl.	1 6	ditto, 6 to 12 inches	25 0
<i>tomentosa</i> Bunney, Kingsland	1 6	from cuttings, 1 foot	20 0
<i>Amygdalus</i>		<i>Celtis</i>	
<i>cochininchinensis</i> Dec., 1½ foot	2 6	<i>australis</i> L., 4 inches	0 6
<i>communis</i> W., 6 to 8 feet	3 6	<i>occidentalis</i> L., 1 to 1½ foot	1 0
<i>dulcis</i> , 1½ feet	2 6	<i>cordata</i> , 6 to 9 inches	0 6
<i>macrocarpa</i> , 3 feet	2 6	<i>Cephalanthus</i>	
<i>pumila</i> W., 2 feet	2 6	<i>inodorus</i> , 1 foot	2 6
<i>Peraica</i> W., fl. pleno, 5 feet	3 6	<i>occidentalis</i> W., 1½ foot	1 6
<i>orientalis</i> W., 2½ feet	3 6	<i>Cerasus</i> L.	
<i>sibirica</i> Lo. C., 2½ feet	2 6	<i>avium</i> <i>Nana</i> , <i>multiplex</i> Ser., 3 to 4 feet	1 0
<i>Aralia</i>		<i>Juliana</i> <i>pendula</i> Dec., 5 to 6 feet	2 6
<i>spindosa</i> W., 6 inches	1 6	<i>Maddalè</i> Mich., 3 to 4 feet	1 6
* <i>Araucaria</i>		<i>Pandus</i> <i>vulgaris</i> Dec., 4 feet	0 6
* <i>brasiliana</i> Lam., 6 feet	84 0	<i>Corylus</i>	
* <i>Cunninghami</i> G. D., 3½ feet	200 0	<i>americana</i> W., 4 feet	1 0
* <i>excelsa</i> H. K., 3 inches	12 6	<i>Colurna</i> W., 1½ foot	1 0
* <i>imbricata</i> W., 1 to 1½ feet	63 0	<i>rostrata</i> W., 3 feet	1 0
<i>Arisa</i>			
<i>Theophrasti</i> , 2½ to 3 feet	0 9		

	Each.		Each.
Cotoneaster, on thorn stocks,		Fraxinus	
*microphylla Wal., 3 feet	2 6	O'rus L., 2½ to 3 feet	1 0
*rotundifolia B. R., 3 feet	2 6	var. globifera, 3 feet	1 6
Crataegus		nigra Bosc., 3 feet	1 0
arbutifolia, 2½ to 3 feet	1 0	platycarpa W., 6 to 9 inches	0 6
new varieties, 2½ to 3 feet	1 6	quadrangulata W., 2 feet	5 0
betulefolia Booth, 1 to 1½ foot	1 6	Richardi Bosc., 4 feet	3 6
coccinea W., 2½ to 3 feet	1 0	rotundifolia Pers., 2½ to 3 feet	0 6
new var., 2 to 2½ feet	1 6	Gleditsia W.	
cordata W., 1 foot	1 6	horrida W., 1½ foot	0 6
Crus-galli L., 5 to 5½ feet	0 6	macracantha L. C., 2½ to 3 feet	1 6
spiciens H. K., 2 to 3 feet	1 6	monosperma PA., 1 foot	1 6
dubia W., 2½ to 3 feet	1 0	sinensis P. S., 9 to 12 inches	1 6
grossularifolia Booth, 1 to 1½ foot	1 6	triacanthos PA., 1½ to 2 feet	0 6
heterophylla Klug., 3 to 4 feet	1 6	inermis, 1½ foot	1 0
mexicana M. et S., 1½ to 2 feet	2 6	Gymnocladus	
medlar-leaved, 3½ to 4 feet	1 6	canadensis W., 3 feet	2 6
obcordata Booth, 2½ to 3 feet	1 0	Halænia	
odoratissima B. R., 2 to 3 feet	1 0	tréptera W., 1½ foot	1 0
olivæformis Booth, 2½ to 3 feet	1 0	Halimodendron	
orientalis Booth, 2½ to 3 feet	1 6	argenteum Fitz., 2½ feet	2 6
Oxyacantha E. B., fol. var., 2 to 2½ feet	1 0	Flex	
fl. pleno, 2½ to 3 feet	1 6	*Aquifolium W. fol. var., 1 to 1½ ft.	1 0—1 6
rosea, 2½ to 3 feet	1 0	*balearica Desf., 1 to 1½ foot	2 6
superb, 2½ to 3 feet	1 6	*Dakota Ph., 4 inches	0 6
péndula, 2½ to 3 feet	1 0	*taxifolia PA., 4 inches	0 6
8½ va., 2 to 2½ feet	1 6	*myrtifolia Lam., 4 inches	0 6
pectinata Booth, 1 to 1½ feet	1 6	*opaca W., 1 to 1½ foot	1 6
spathulata PA., 1 foot	0 6	*Pyrædo W., 1½ foot	1 6
stipulacea Booth, 3 feet	2 6	*recurva Lk., 1½ foot	1 6
tanacetifolia B. R., 2½ to 3 feet	1 0	Juglans	
tomentosa Booth, 2½ to 3 feet	1 6	alba W., 1 foot	0 6
without stone, 2½ to 3 feet	1 6	amara Mich., 1½ to 2 feet	0 6
pyrifolia W., 1 foot	0 6	aquatica Nuttall, 6 inches	0 6
punctata W., 2½ to 3 feet	1 0	cinerea PA., 1 to 1½ foot	0 6
sanguinea Pall., 3½ feet	1 0	fraxinifolia Lamb., 1½ to 2 feet	0 4
Cunninghamia		myristiciformis, 2 ft. (seed from Charlwood)	1 0
*sinensis R. Br., 3 feet	20 0	nigra W., 1 to 1½ foot	0 6
6 to 12 inches	7 6	olivæformis W., 1 to 1½ foot	0 6
Cytisus, on laburnum stocks,		tomentosa Nutt., 6 inches	0 6
argenteus W., 5 feet	3 6	Kœlreutèria	
capitatus W., 5 feet	3 6	paniculata Dec., 2 to 2½ feet	1 6
nigricans W., 3½ feet	2 6	Liquidambar	
purpureus W., 3 feet	3 6	orientale L., 2 feet	2 6
sessilifolius W., 3½ feet	2 6	Styracis W., 1 to 1½ foot	1 6
alpinus W., 4 feet	2 6	Liriodendron	
Laburnum W., fol. variegatis, 4 feet	1 6	Tulipifera W., 2 to 2½ feet	1 0
quercifolium, 4 feet	2 0	Mespilus	
péndulum, 4 feet	2 6	pyracantha, 1 to 1½ foot, pots	1 6
purpurascens, 3½ to 4 feet	1 6	Morus	
Waldenii, 6 feet	3 6	alba fruc. albo W., 1½ to 2 feet	0 6
alpinus W., fragrans, 3½ feet	1 6	nigra, 1½ to 2 feet	0 6
Diospyros		rubra, 1½ to 2 feet	0 6
lotus W., 4 to 6 inches	0 6	Morettiana Booth, 1½ foot	2 0
virginiana W., 4 to 6 inches	0 6	pennsylvanica Nor., 3 feet	3 6
Euonymus		Ostrya	
americana W., 3 to 3½ feet	1 0	virginica W., 4 feet	1 6
atropurpurea W., 4 to 5 feet	1 0	vulgaris W., 1 to 1½ foot	1 0
europæa W., 3½ feet	0 4	Photinia	
fruct. albo, 3½ feet	1 6	*arbutifolia Lindl., 1 to 1½ foot	2 6
*japonica W., 1 foot, coccineo, 3 feet	1 6	*serrulata Lindl., 1 to 1½ foot	2 0
fol. adreis variegatis, 1 foot	5 0	Pinus	
fol. argenteis variegatis, 1 foot	7 6	*Cembra W., 6 inches (in pots)	0 9
Fagus		*Banksiana Ph., 2 feet	10 6
syriatica W. asplenifolia, 1 to 1½ feet	1 6	*halepensis W., 4 to 6 inches	0 9
purpurea, 5 to 6 feet	1 6	1 to 1½ foot	1 0
laciniata, 3 feet	1 6	*excelsa Lamb., 4 inches	10 6
péndula, 5 feet	2 6	*gerardiana Wal., 3 inches	25 0
fol. adreis varieg., 2 feet	2 6	*inops PA., 6 to 12 inches	1 0
fol. argenteis varieg., 2 feet	2 6	*longifolia W., 1½ foot	25 0
Fraxinus		*nepalensis Cels, Paris, 2 feet	25 0
acuminata Lamb., 2 to 3 feet	0 6	*palustris PA., 6 inches	3 6
americana W., 2½ to 3 feet	0 6	*Pinea W., 6 to 9 inches	0 9
glabra, 2 to 3 feet	1 0	*ponderosa Dow., 2 feet	15 0
excelsior lucida W., 2½ feet	1 0	*pungens PA., 1 foot	1 0
aurea, 2½ to 3 feet	0 9	*rigida PA., 1 foot	1 0
fol. var., 2½ feet	1 0	*Sabineana Douglas, 1 to 1½ foot	25 0
péndula, 6 feet	2 6	*serotina PA., 1 foot	1 6
heterophylla Pahl., 2½ feet	1 0	*Strobilus W., var. nana Booth, 5 ft.	10 6
juglandifolia W., 1 to 1½ foot	0 6	*Teda PA., 4 to 6 inches	1 6
lenticiifolia péndula W., 5 feet	3 6	mitis Mich., 3 inches	0 6
nana Bosc., 3 to 4 feet	1 0		

	Each.		Each.
Abies Sal.		Robinia	
*canadensis H. K., 1 to 1½ foot	(in pots) 0 9	Pseudacacia W., 1 year's seedling, per 100	s. d.
*Cianbrasiliana H. K., 1 foot	2 6	1½ to 2 feet	0 6
*excelsa fol. var., Poir., 1 foot	3 6	crispa, 1½ foot	1 6
*balsamea var. longifol. Booth, 5 ft.	7 6	monstruosa, 2½ feet	1 6
*Douglasii Hort., 1½ foot	25 0	tortuosa, 2½ to 3 feet	2 0
*Fraseri Ph., 1 foot	2 6	gigantea Booth, 2 to 3 feet	2 0
*Mensiæsi Douglas, 4 inches	63 0	hispidæ W., 3 to 4 feet	1 0
*Morinda Wal., 9 to 12 inches	10 6	grandiflora, 4 to 4½ feet	1 6
*Picea var. tortuosa Booth, 4 ft.	7 6	inermis, 1½ to 2 feet	1 6
*Pickæ Fla., 1 foot	2 6	microphylla Lo. C., 2 to 3 feet	1 6
*taxifolia Lamb., 1½ foot	3 6	stricta Lk., 5 to 6 feet	1 6
*rubra Lamb., 4 to 9 inches	0 6	viscaria W., 2 to 3 feet	1 6
Larix Sal.		alba, 3 feet	2 6
europæa var. pendula Dec., 3 feet	1 6	horrida, 2 to 3 feet	2 6
microcarpa Lamb., 6 feet	3 6	amorphæfolia Lk., 2 to 3 feet	1 6
pendula Lamb., 3½ feet	5 0	Sâlix	
Plânera		annularis Hort.	1 0
Richardii Mich., 1½ foot	2 6	var. pubescens	2 6
Plâtanus		babylonica L.	0 6
acerifolia W., 3 feet	2 6	var. bedfordiensis	0 6
cuneata W., 1 foot	2 0	var. Napoleonæ	1 6
digitata Booth, 1 foot	2 0	moschata Booth	2 0
occidentalis W., 3 feet	0 9	Sixty distinct species, 2 plants of each for	42 0
orientalis W., 3 feet	1 0	Sambucus	
Pópulus		canadensis W., 1½ foot	1 6
egyptiaca Booth, 2 to 2½ feet	1 6	nlgra W., 3 to 4 feet, per 100	10 0
Lindleyana var. crispa Booth, 1½ foot	2 0	fol. var., 1½ foot	1 0
trépida W., 1½ to 2 feet	0 6	rotundifolia Booth, 1½ foot	1 6
sp. from Belgium, Booth, 3 feet	2 6	Sophora H. K.	
suavolevis Fis., 1½ foot	3 6	japonica W., 1 to 1½ foot	1 0
Prunus		fol. var., 2 feet	2 6
Coccolilla Tem., 4 to 4½ feet	3 6	pendula, 1½ foot	3 6
pâmila W., 1 foot	2 6	*grandiflora, 1 foot	5 0
spindæ fl. pleno W., 2½ feet	1 6	Tâxus	
Prûlea		*baccata W., 1½ to 2 feet, per 100	15 0
trifoliata L., 3 to 3½ feet	1 6	" " 2 to 3 feet	20 0
Pýrus		" " fol. var. 1½ foot, each	2 6
amygdaliformis Vil., 3 feet	2 0	*canadensis W.	3 6
baccata W., 4 feet	1 6	*hibernica Hooker, 6 inches	0 6
communis fol. var. W., 3 feet	1 6	" " 2 to 3 feet	2 0
fl. pleno, 2½ to 3 feet	1 6	Thûja	
semidouble, 3 to 3½ feet	1 6	*occidentalis L., 9 to 12 inches	0 4
coronaria W., 4 to 4½ feet	1 6	" " 2 to 2½ feet	0 9
edulis W., 3 to 4 feet	1 6	*orientalis L., 4 to 6 inches	0 6
elasagnifolia Pall., 3 to 3½ feet	2 6	" " 2 to 2½ feet	1 0
intermedia W., 2½ to 3 feet	1 6	*plicata Lam., 6 inches	5 0
lanuginosa Dec., 2½ to 3 feet	1 6	Tilia	
melanocarpa Pa., 3 feet	2 0	americana L., 2 to 3 feet	1 0
nepalensis Lo. C., 1 to 1½ foot	2 6	nlgra, 2 to 3 feet	1 6
pienatifida F. B., 2½ to 3 feet	1 6	canadensis Booth, 2½ to 3 feet	1 0
Pollværia W., 2½ to 3 feet	1 0	fol. variegata, 3 to 3½ feet	1 6
prunifolia W., 5 feet	1 6	parvifolia Ehrh., 2½ to 3 feet	1 0
var. coccinea, 5 to 5½ feet	1 6	asplenifolia, 3 feet	0 6
dúlcis, 5 to 5½ feet	1 6	asplenifolia, 1½ to 2 feet	0 6
Harvey's new, 5 to 6 feet	1 6	adrea, 2½ feet	2 0
North's new, 5 to 6 feet	1 6	laxiflora Mx., 2½ to 3 feet	1 0
spectabilis W., 3½ feet	1 6	pubescens H. K., 5 feet	1 6
upsalensis Lo. C., 2½ to 3 feet	3 6	Ulmus	
Quercus		americana Pa., 2 to 3 feet	1 0
Banisteri Mich., 1 foot	1 0	betulifolia Booth, 2½ to 3 feet	1 0
bicolor Pa., 6 to 9 inches	0 4	betuloides L., 2½ to 3 feet	1 0
Catesbei W., 6 to 9 inches	1 0	campêstris L., 3 to 3½ feet	0 6
coccinea Pa., 6 inches	0 6	fol. argentea, 1½ to 2 feet	1 0
fastigiata Lam., 1½ foot	3 6	fol. aurea, 2 to 2½ feet	1 0
*Flex W., 1½ foot	1 6	* " 1½ to 2 feet	1 0
" " 2 years' seedlings, in pots, per 100	30 0	asplenifolia, 1½ to 2 feet	1 6
" " ditto in beds, per 100	20 0	var. stricta, 2½ to 3 feet	0 9
*Lucombeana Swt., 6 inches	0 6	crispa W., 2½ to 3 feet	0 9
" " 3 to 3½ feet	3 6	glabra E. H., 2½ to 3 feet	0 9
" " 6 to 7 feet	3 6	glomerata Booth, 1½ foot	2 6
grammîna W., 1 foot, in pots	0 6	gigantea, 2½ to 3 feet	0 6
lyrata Pa., 1 foot	0 6	lungosa, 2½ to 3 feet	1 0
*maritima Pa., 9 inches	0 6	microphylla Perr., 1½ to 2 feet	0 9
palustris Pa., 6 to 9 inches	0 4	myrtifolia, 1½ to 2 feet	1 6
*Phellos Pa., 1 to 1½ foot	1 0	nana, 6 inches	0 9
Prunus Pa., 3 to 9 inches	0 6	plicata, 3 to 4 feet	0 9
sp. from America, 1½ foot	1 0	pâmila Pall., 1½ to 2 feet	0 6
*Shber W., 1½ foot	1 0	sibirica, 3 to 4 feet	1 0
Taxia Lam., 2 years' seedlings, per 100	10 0	scabra Mic., 1 foot	0 9
" " 3 years' ditto per 100	15 0	suberba March, 2½ to 3 feet	0 6
triloba Pa., 1 foot	0 6	tortula, 1½ to 2 feet	0 6
Edbur fol. var. W., 2 feet	1 6	tortuosa, 6 inches	1 0
fol. atro-purpureis, 2 feet	1 0	viminalis, 1½ foot	3 6
		viscaria, 1½ to 2 feet	1 0

	Each s. d.	Each L. s. d.
<i>Ulmus</i>		
new Exeter, 2½ to 3 feet	1 0	
black Canadian, 1 to 1½ foot	1 0	
species from Hamburg, 1 to 2½ feet	1 0	
Those without authorities are named as in the Edinburgh Botanic Garden.		
		ORNAMENTAL TREES.
		First assortment, per 100
		Second ditto
		Third ditto
		5 0 0
		2 10 0
		1 5 0

SHRUBS AND AMERICAN PLANTS.
(Those marked thus * are Evergreens.)

PLANTS REQUIRING PEAT SOIL.		
Andróneda		
<i>arborea W.</i> , 1½ foot	5 0	
<i>buxifolia Lam.</i> , 1 foot	7 6	
* <i>Catesbaei W.</i> , 1 to 1½ foot	2 6	
* <i>calyculata Ph.</i> , 1½ to 2 feet	0 9	
<i>nana</i> , 1½ foot	0 9	
<i>frondosa Ph.</i> , 1½ foot	1 6	
<i>mariana W.</i> , 1½ foot	1 6	
<i>speciosa</i> var. <i>pulverulenta</i> , 1½ foot	1 0	
* <i>polifolia W.</i> , 1½ foot	0 9	
do. in 10 varieties	0 9	
<i>speciosa Ph.</i> , 1½ foot	1 6	
* <i>tetragona L.</i> , ½ inches	3 6	
*Arbutus		
* <i>alpina W.</i>	3 6	
* <i>Andrachne W.</i> , 2½ feet	5 0	
var. <i>serratifolia</i> , 2½ feet	5 0	
* <i>mucronata L. fl.</i> , 6 inches	2 6	
* <i>albica</i> , 6 inches	3 6	
* <i>procera Dow.</i> , 1½ foot	10 6	
* <i>nepalensis</i> , 1½ foot	31 0	
* <i>Uredo W.</i> , 9 to 12 inches, in pots,	1 0	
1 to 1½ foot	1 6	
<i>fl. pleno</i> , 1 foot	3 6	
<i>scarlet</i> , 1 foot	2 6	
* <i>Uva ursi W.</i>	0 6	
* <i>aitrica</i> , 6 inches	1 6	
Azalea		
<i>calendulacea Mich.</i> , 1½ foot	2 6	
<i>crocea</i> , 2 feet	5 0	
<i>glauca Lam.</i> , 1 to 1½ foot	2 0	
<i>glabra</i> , 1 to 1½ foot	1 6	
<i>nitida Ph.</i> , 1 to 1½ foot	2 6	
<i>nudiflora L.</i> , 1 foot	2 0	
<i>alba</i> , 1½ foot	2 6	
<i>pontica L.</i> , 1½ to 2 feet	0 6	
<i>alba</i> , 1 foot	5 0	
<i>viscosa L.</i> , 1 to 1½ foot	1 6	
<i>alba</i> , 1½ foot	2 6	
<i>vittata</i> , 1½ foot	2 6	
Calycánthus		
<i>fertilis W.</i> , 1½ foot	2 6	
<i>floridus W.</i> , 1½ foot	0 9	
<i>oblongifolius Nut.</i> , 2½ feet	7 6	
<i>asplenifolius Booth.</i> , 3 feet	7 6	
Chimonánthus		
<i>fragrans Lindl.</i> , 1½ foot	3 6	
<i>grandiflorus Lindl.</i>	5 0	
1½ foot	5 0	
Ceanóthus		
<i>americanus W.</i> , 1 to 1½ foot	1 0	
Cléthra W.		
<i>acuminata Ph.</i> , 2½ feet	1 0	
<i>alinifolia Ph.</i> , 2 to 2½ feet	1 0	
<i>paniculata W.</i> , 2 to 2½ feet	1 0	
<i>pumila Smith of Agr.</i> , 1 foot	1 6	
*Cneórum		
* <i>tricoecum L.</i> , 6 inches	0 6	
*Dryas		
* <i>Drummondii Hooker</i>	1 0	
* <i>integrifolia Wahl.</i>	0 6	
* <i>octopétala W.</i>	0 9	
*E'mpetrum		
* <i>algrum L.</i>	0 6	
*Erica		
* <i>ariborea L.</i> , 1 foot	1 6	
* <i>australis L.</i> , 1 foot	1 6	
* <i>carnea L.</i>	0 6	
* <i>carnea rubra</i>	0 6	
* <i>ciliaris L.</i>	1 0	
* <i>cinerea alba H. K.</i>	1 0	
* <i>mediterranea L.</i> , 1½ foot	1 0	
* <i>scioaria L.</i> , 1½ foot	1 0	
* <i>stricta Donn.</i> , 1 foot	0 9	
* <i>Tetralix L.</i>	0 9	
<i>alba</i>	0 9	
* <i>vagans L.</i>	0 6	
<i>alba</i>	0 9	
<i>rubra</i>	0 9	
* <i>vulgaris alba L.</i>	0 9	
<i>fl. pleno</i>	0 9	
Fothergilla		
<i>alinifolia L.</i> , 1½ to 2 feet	1 6	
<i>pubescens</i> , 1½ to 2 feet	1 6	
*Gaulthéria		
* <i>procumbens W.</i>	0 6	
* <i>Shallon Ph.</i>	1 0	
* <i>serpyllifolium</i>	1 6	
Gordónia		
<i>pubescens W.</i> , 1½ foot	3 6	
Itea		
<i>virginica L.</i> , 1½ to 2 feet	1 0	
Kálmia		
* <i>angustifolia W.</i> , 1 to 1½ foot	1 0	
<i>fol. var.</i> , 1½ foot	1 0	
<i>rubra</i> , 1 foot	1 0	
<i>nitida</i> , 1 foot	2 6	
<i>glauca W.</i> , 1 foot	1 0	
<i>latifolia W.</i> , 1 to 1½ foot	2 6	
<i>serotina Smith of Agr.</i> , 1 foot	2 6	
*Ledum		
<i>buxifolium W.</i>	2 6	
<i>canadense Lod.</i> , 1½ foot	1 6	
<i>latifolium W.</i> , 1½ foot	1 6	
<i>palustre W.</i> , 1 foot	2 0	
<i>rhympifolium</i>	1 6	
*Linnaea		
* <i>borealis Gro.</i>	0 9	
Magnolia		
<i>acuminata W.</i> , 3 feet	2 6	
<i>auriculata W.</i> , 3 feet	5 0	
<i>conspicua H. K.</i> , 2½ feet	5 0	
<i>cordata Ph.</i> , 3 feet	3 6	
<i>fuscata H. K.</i> , 1 foot	2 6	
<i>glauca Ph.</i> , 6 inches	1 0	
<i>Thomsoniana</i> , 4 feet	5 0	
<i>gracilis Sal.</i> , 3 feet	2 6	
* <i>grandiflora W.</i> , 2 feet	5 0	
<i>obovata</i> , 5 feet	7 6	
<i>Exmouth</i> , 2½ feet	5 0	
<i>macrophylla Ph.</i> , 1½ foot	10 0	
<i>purpurea Booth.</i> , 2 to 2½ feet	9 6	
<i>tripetala W.</i> , 4 feet	2 6	
Menziesia Sm.		
<i>globularis Sal.</i> , 1 foot	2 6	
* <i>polifolia S.</i> , 1 foot	0 9	
* <i>alba</i> , 6 inches	2 6	
* <i>pumila</i> , 3 inches	1 6	
* <i>caerulea Wahl.</i>	3 6	
*Mitchella		
* <i>repens W.</i>	1 0	
*Myrica		
* <i>carolinensis Wam.</i> , 1 to 1½ foot	0 9	
* <i>cerifera L.</i> , 1 to 1½ foot	0 9	
* <i>Gale L.</i> , 1 to 1½ foot	0 6	

	Each. s. d.
*Oxyococcus	
*macrocarpus Pers.	0 6
*palustris Ph.	0 9
*Polýgala	
*Chamaebúxus L.	0 9
Rhodóra	
canadénsis W., 1 to 1½ foot	1 6
Rhododéndron	
azaleoides Hort., 2½ feet	2 6
*arboresum Sm., 1½ foot	7 6
hybridum Hort., 1½ foot	3 6
catawbíense Ph., 4 to 6 inches	1 0
hybridum Hort., 2½ to 3 feet	2 6
*caucasicum W., 1 foot	3 6
*Chamaecistus W.	3 6
diátricum W., 1 foot	2 0
*atrovirens, 1½ feet	2 6
*ferrugineum W., 6 to 9 inches	1 0
*hirátum W., 1 foot	1 0
*leppónicum Wahl., 6 inches	30 0
*máximum W., 6 to 9 inches	0 9
1½ to 2 feet	2 0
*myrtifolium Led., 1½ foot	3 6
odoratum Hort., 1½ foot	5 0
*poncticum W., 6 to 9 inches	0 6
1½ to 2 feet	1 6
2½ to 3 feet	2 0
var. 1½ foot	8 6
*Lowii, 1 foot	30 0
*magnoliacólium,*3 feet	2 6
*álbum Ph., 1½ foot	3 6
*angustifolium, 1 foot	1 6
*atropurpúreum, 2 feet	3 6
*áureum, 2 to 2½ feet	2 6
fl. pleno,	105 0
*roseum, 1½ foot	3 6
*kalmíoides, 1½ foot	2 0
fol. argenteis, 1½ foot	3 6
*rotundifolium, 2½ feet	2 6
*punctatum W., 2 feet	2 0
*ventustum Wal.	30 0
Stuárta	
virgínea Dec., 1½ foot	2 6
Vaccínium	
*Flis idæ'a májor L.	0 9
máxima	0 9
Vítex	
*Ágnus castus L., 1½ foot	1 0
4 to 6 inches	0 6

PLANTS NOT REQUIRING PEAT SOIL

Amórpha	
glabra Desf., 6 to 9 inches	0 6
fruticosa L., 1½ to 2 feet	0 9
Lewisií Lo. C., 1½ to 2 feet	1 0
Artemisia	
arboréscens L.,*3 feet	1 0
Abrótanium L., 1½ foot	0 6
argentea H. K., 1½ foot	1 0
Asímína	
triflora Donal, 1½ to 2 feet	2 6
*Astrágalus	
*Tragacáantha L., 4 to 6 inches (in pots)	0 9
*Aúcuba	
japónica L., 6 to 12 inches, per 100	50 0
1½ to 2 feet	1 0
do. in pots	1 6
*Bácharis	
halimifolia L., 6 inches	1 0
Benthámia	
*fragifera, 6 to 12 inches	3 6
*Bérberis	
*aristata Dec., 6 inches	2 6
*asiática Rox., 6 inches	5 0
canadénsis Mú., 1 foot	1 0
crataegínea Dec., 1½ foot	2 6
*dúlcis Swt., 1 to 1½ foot	5 0
*silicifolia Forst., 1 foot	2 6

	Each. s. d.
*Bérberis	
*silicifolia glauca, 1 foot	2 6
ovalifolia Booth, 1 foot	2 0
*empetrifolia Lamob., 6 inches	10 0
hybrida Booth, 6 inches	0 6
sinénsis Desf., 1 foot	0 6
vulgáris álba L., 1½ foot	1 6
álba, 1½ foot	1 6
lutea, 1½ foot	1 0
stoneless, 1½ foot	1 0
fruc. cartilago, 1½ foot	2 0
*Mahónia	
*Aquifolium Nat., 4 to 6 inches	1 0
1 to 1½ foot	3 6
*fasciculáris Dec., 1 foot	10 6
*glumacea Dec., 1 foot	20 0
*repens G. Don., 1 foot	10 0
*Bórya	
*Águstrina W., 1 to 1½ foot	2 6
Búddlea	
glabba L., 1½ to 2 foot	0 6
Bupleúrum	
fruticosum Thun., 1 foot	1 6
*Búxus	
*balearica W., 6 inches	1 0
*sempervirens W., 1½ foot, per 100	12 6
fol. adreia, 1½ foot, per 100	20 0
fol. argenteis, 1½ foot, per 100	20 0
*myrtifolia, 1 foot	0 4
Cássia	
marilandica L., 1½ foot	0 9
Catálpa J.	
*syriacifolia H. K., 1½ foot	0 9
Cérasus J.	
Laurocérasus Lot.	0 6
lusitánica Led.	0 6
Chionánthus	
virgínea L., 2 feet	1 6
*Cístus	
*acutifolius Swt., 1½ foot	1 0
*álbidus L., 1½ foot	1 0
*créticus L., 1 foot	0 9
*Cupaniárus Presl, 1 foot	0 9
*hirátum Lamob., 1 foot	0 9
*ilicicus Pers., 1 foot	0 9
*ladaniferus L., 1½ to 2 feet	0 6
*latifolius Swt., 1 to 1½ foot	0 6
*láxus H. K., 1 to 1½ foot	1 0
*Libanotis W., 6 inches	1 0
*lusitánicus Booth, 6 inches	1 0
*monspehiénsis L., 1 foot	0 9
*platysépalus Sweet, 1 foot	0 9
*populifolius Lam., 1 foot	0 9
*salvifolius L., 1 foot	0 9
*Helianthemum	
*algarvénse Dec., 1 foot	1 0
*formosum Dec., 1 foot	1 6
Collection of 30 sorts named, 1 plant } of each	20 0
*Clíanthus	
*puniceus Lindl., 6 to 9 inches	3 6
Colútea	
arboréscens W., 1½ to 2 feet	0 4
Córchorus	
japónicus L., 2 to 2½ feet	0 6
Comptónia	
*asplenifolia H. K., 1 foot	1 0
Coriária	
myrtifolia L., 6 inches	0 6
Córnus	
canadénsis L., 2 to 2½ feet	0 6
candidíssima Booth, fol. var., 1 foot	1 6
fórida L., 1 foot	1 0
máscula L., 2½ feet	1 0
paniculáta Herit., 3 to 3½ feet	1 0
sangúinea L., 3 to 3½ feet	0 4
fol. var., 3 to 3½ feet	0 6
sibírica Lo. C., 1½ to 2 feet	1 0

	Each. s. d.		Each. s. d.
Coronilla		Hibiscus	
<i>E'merus L.</i> , 1½ to 2 feet	0 6	<i>syriacus L.</i> , 1½ to 2 feet	0 6
<i>glauca L.</i> , 1½ to 2 feet	1 6	fol. var. 1½ to 2 feet	0 9
fol. var. 1½ to 2 feet	1 6	Hippophae	
Cotoneaster		<i>conferta Wal.</i> , 6 inches	0 6
<i>acuminata Lindl.</i> , 1 foot	1 6	<i>salicifolia D. Don.</i> , 2 feet	2 6
<i>affinis Lindl.</i> , 1 foot	2 6	Hydrangea	
<i>arbutifolia Booth.</i> , 1 to 1½ foot	1 0	<i>arborescens L.</i> , 1 to 1½ feet	0 9
<i>frigida Lindl.</i> , 3 feet	3 6	<i>hortensis Sm.</i> , 1 to 1½ foot	1 0
1 foot	0 6	<i>quercifolia Bort.</i> , 2 feet	1 6
<i>microphylla Wal.</i> , 1 to 1½ foot	1 6	<i>radiata Walt.</i> , 1½ foot	0 9
6 to 12 inches	1 0	Juniperus	
<i>rotundifolia Wal.</i> , 1 to 1½ foot	1 6	<i>communis L.</i> , 4 to 6 inches	0 2
<i>tomentosa Lindl.</i> , 1 to 1½ foot	1 6	var. <i>stricta</i> , 1½ foot	0 6
<i>Ura-arsi Hort.</i> , 1 foot	1 0	<i>chinensis L.</i> , 1 foot	2 0
<i>vulgaris Lindl.</i> , 1½ foot	0 6	<i>lycia L.</i> , 3 inches	1 6
Cydonia		<i>prostrata Mc.</i> , 4 inches	1 0
<i>japonica P.S.</i> , 1 to 1½ foot	0 6	<i>recurva Ham.</i> , 1 foot	2 6
fl. pleno, 1 foot	2 0	<i>sibirica Burg.</i> , 6 inches	3 6
fl. albo, 1½ foot	1 6	<i>suecica Mil.</i> , 1 to 1½ foot	0 9
<i>lusitânica Mil.</i> , 1½ foot	1 6	<i>amariscifolia</i> , 1 to 1½ foot	5 0
<i>sinensis Thoun.</i> , 1½ foot	1 6	<i>virginiana L.</i> , 1 to 1½ foot	0 6
5 to 6 feet	1 0	Lavandula	
Cupressus		<i>dentata L.</i> , 1 foot	1 0
<i>lusitânica Thun.</i> , 1½ foot	1 6	<i>spica W.</i> , 1 foot	0 6
<i>sempervirens L.</i> , 1½ foot (in pots)	1 0	Laurus	
horizontalis, 1½ foot (in pots)	1 6	<i>benzoin L.</i> , 1 to 1½ foot	1 6
<i>thyoides L.</i> , 1 foot	1 6	<i>nobilis W.</i> , 6 to 9 inches	0 6
Taxodium		1 to 1½ foot (in pots)	1 0
<i>distichum Rich.</i> , 1½ foot	1 0	2 to 2½ feet	1 6
<i>pendulum Booth.</i> , 2 feet	3 6	<i>undulata</i> , 6 inches	1 0
Cytisus		<i>salicifolia</i> , 1 to 1½ foot	1 0
<i>elongatus W. et K.</i> , 2½ to 3 feet	1 0	<i>scabra Raf.</i> , 1½ foot	2 6
<i>nigricans L.</i> , 1½ foot	0 9	Ligustrum	
<i>purpureus Scop.</i> , 1 to 1½ foot	0 9	<i>lucidum L.</i> , 1½ to 2 feet	1 0
albus, 1 foot	2 0	<i>vulgare L.</i> , fol. var. 1½ foot	0 6
<i>supinus Jac.</i> , 1 to 1½ foot	1 0	fruc. luteo, 1½ foot	0 9
Daphne		var. <i>foliosum</i> , 1½ foot	0 9
<i>alpina L.</i> , 1 to 1½ foot	2 6	Lonicera R. et S.	
<i>Cneorum L.</i> , 1 foot	1 6	<i>ciliata Ph.</i> , 1½ foot	1 0
fol. var. 1 foot	2 0	<i>sibirica Vest.</i> , 1½ foot	1 6
<i>collina Sm.</i> , 1½ foot	2 6	<i>tatarica L.</i> , 1½ to 2 feet	1 6
<i>Gnidium L.</i> , 1½ foot	2 6	<i>villbosa R. et S.</i> , 1 to 1½ foot	1 6
<i>hybrida Swt.</i> , 1 to 1½ foot	2 6	<i>Xyloteum W.</i> , 1½ to 2 feet	1 0
<i>Lauræola L.</i> , 1 to 1½ foot	0 6	Maclura	
fol. var. 1 foot	2 6	<i>aurantiaca Nutt.</i> , 1½ foot	3 6
<i>Mezereum L.</i> , 6 to 12 inches	0 4	Nyssa	
albus, 1 foot	1 0	<i>aquatica L.</i> , 1 foot	0 6
autumnale, 1 to 1½ foot	2 0	Ononis	
<i>neapolitana Lod.</i> , 1 to 1½ foot	2 6	<i>Natrix Dec.</i> , 1½ foot	1 0
<i>pontica L.</i> , 1 to 1½ foot	0 9	<i>rotundifolia L.</i> , 1 foot	0 6
ruba, 1 to 1½ foot	2 0	Paliurus Tou.	
<i>Tarson-ratra L.</i> , 1 foot	3 6	<i>aculeatus Lam.</i> , 4 to 6 inches	0 6
Dirca		Paeonia	
<i>palustris L.</i> , 1 foot	2 6	<i>Moutan</i> , 1 foot	3 6-5 0
Deutzia		<i>papaveracea H. K.</i> , 1 foot	7 6
<i>scabra Don.</i> , 6 inches	7 6	<i>rosea</i> , 1 foot	10 6
Edwardsia		Phillyrea	
<i>grandiflora Sal.</i> , 2½ feet	3 6	<i>latifolia L.</i> , 1 to 1½ foot	1 0
<i>microphylla Sal.</i> , 6 inches	1 0	<i>ligustrifolia W.</i> , 1 to 1½ foot	1 6
Eleagnus		<i>media L.</i> , 1 foot	1 0
<i>angustifolia L.</i> , 1 to 1½ foot	1 0	<i>olivifolia H. K.</i> , 1 to 1½ foot	1 6
<i>macrophylla Sweet.</i> , 1 to 1½ foot	1 0	Phlomis	
Eucalyptus		<i>fruticosa L.</i> , 1½ to 2 feet	0 6
<i>pulverulenta Lk.</i> , 1½ foot	1 0	Pittosporum	
Escallonia		<i>Tobira H. K.</i> , 6 inches	1 0
<i>floribunda H. et B.</i> , 1 foot	1 6	Philadelphus	
<i>glandulosa Sm.</i> , 1½ foot	1 0	<i>coronarius L.</i> , 2½ to 3 feet	0 4
<i>ruba Pers.</i> , 1 foot	1 6	fol. var. 1½ to 2 feet	0 6
Fontanésia		fl. pleno, 2 to 2½ feet	0 9
<i>phillyreoides Lab.</i> , 4 inches	0 6	<i>gracilis L. C.</i> , 1½ to 2 feet	1 0
Genista		<i>grandiflorus W.</i> , 2 feet	1 0
<i>florida L.</i> , 1 foot	1 0	<i>inodorus Mil.</i> , 1½ to 2 feet	0 6
<i>lusitânica L.</i> , 1 foot	1 0	Piptanthus	
<i>sagittalis L.</i> , 6 inches	0 9	<i>nepalensis Swt.</i> , 1½ foot	1 0
<i>tincbria L.</i> , fl. pleno, 1 foot	1 6	Pistacia	
Garrya		<i>vera</i> , 6 inches	0 6
<i>elliptica, D. Don</i>	7 6		
Hartogia Thun.			
<i>capensis L.</i> , 1 foot	0 6		

	Each. s. d.
Prinos	
grunifolius Desf., 1 foot	2 6
Punica	
Granatum W., 1 foot	1 0
mútiplex, 1 foot	1 6
sáva, 1 foot	1 6
* Rhamnus	
*alaternus L., 1 to 1½ foot	0 9
*argenteus, 1 foot	1 6
*aureus, 1 foot	1 0
*maculátus, 6 inches	1 0
alpinus L., 1 foot	2 6
amifolius Herit., 2 to 2½ feet	1 6
crenulátus, 1 to 1½ foot	2 0
Frángula L., 1½ foot	1 6
*latifolia Herit., 2½ feet	1 6
Rhus	
aromática Jac., 1 to 1½ foot	1 6
Cótinus L., 1 foot	0 9
élegans W., 1½ to 2 feet	0 9
glabra L., 1½ foot	1 0
radicans L., 1½ foot	0 9
Toxicodéndron L., 1 to 1½ foot	0 9
typhina L., 2½ feet	0 9
vernix L., 6 to 9 inches	1 0
Ribes	
aéreum Ph., 2 to 2½ feet	0 9
divaricatum Don., 2 feet	1 0
flóridum Dec., 1½ to 2 feet	1 0
glutinibum Douglas, 1 foot	3 6
grácle Booth, 1½ foot	1 0
lacustre Dec., 1½ foot	1 0
malvifolium Hort., 1 foot	5 0
nigrum fol. var. L., 1 foot	0 6
fruc. viridi, 1½ foot	0 6
recurvatum Booth, 1½ to 2 feet	1 6
sanguineum Ph., 2½ to 3 feet	0 9
atrorubrum, 2½ to 3 feet	1 0
var. serotinum, 1½ feet	1 6
speciosum Dec., 1½ foot	2 6
Roses	
A collection of 300 named sorts, 2 plants of each for £10	
Mixed, per 100, 15s.	
Moss, 12 sorts, £9, or from 6d. to 5s. each	
Chinese, a collection of 80 select sorts for £8 6s. (one plant of each).	
Scotch, a collection of 80 select sorts, two plants of each, for £9 10s.	
Standard from 4 to 6 feet, including many of the finest new sorts, 3s. 6d. to 5s. 6d.	
* Rosmarinus	
*officinális L., 1 foot	0 6
fol. var., 1 foot	1 0
Rubus	
ácticus E. B., 4 to 6 in.	1 0
californicus Douglas, 1½ foot	1 0
discolor Weihe, 3 feet	0 8
leucodermus Booth, 3 feet	0 9
nootkaténsis Max., 3 feet	0 2
odorátus W., 3 feet	1 0
spectábilis Ph., 1½ foot	0 9
* Ruscus	
*aculeatus L., 1 foot	0 9
*Hypoglóssum L., 1 foot	0 6
*láxus L., 1 foot	1 6
*racemósus L., 1 foot	1 6
* Salix	
*herbácea L., 3 in.	1 0
Salisbúria	
adiantifolia Sm., 1 to 2 feet	2 6
Shephérdia	
canadénsis Nut., 1½ foot	1 0
* Spártium	
*júnceum L., 1½ to 2 feet	0 4
fl. pleno, 1½ feet	1 0
*multiórnum H. K.	0 6
Staphyléa	
tribília L., 2 to 3 feet	0 4

	Each. s. d.
Sutherlandia	
frutescens H. K., 1½ foot	1 0
Spiræa	
aristifolia Sm., 1 foot	1 6
bélla Sims., 2 to 2½ feet	1 0
crenata W., 1½ to 2 feet	1 0
canadénsis Booth, 1½ to 2 feet	1 0
incarnata Booth, 1½ foot	0 6
flexuosa Fir., 1½ foot	1 0
opulifolia W., 1½ foot	0 6
nana, 1 foot	0 6
levigata W., 1 foot	0 6
salicifolia W., 3 feet	0 4
carnea, 2 to 2½ feet	0 6
rubra viridis, 2 to 2½ feet	0 9
sorbifolia W., 1½ foot	0 6
zhalictroides W., 1 to 1½ foot	0 9
tomentosa W., 1 foot	1 0
triflora W., 1 foot	1 6
amifolia W., 1½ foot	0 6
Symphória Ph.	
glauca, 1½ foot	1 0
montana Kth., 1 foot	0 9
fol. var. 1 to 1½ feet	1 0
punicea Sims., 1½ to 2 feet	1 0
racemosa Ph., 2 to 2½ feet	0 6
Syringa	
chinénsis L., 1 to 2 feet	0 6
pérsica L., 1 to 2 feet	0 3
álba, 1 to 2 feet	0 6
vulgáris L., 3 to 3½ feet	0 3
álba, 1½ foot	0 6
purpúrea, 2 to 3 feet	0 9
rubra, 1½ foot	0 9
semiplena, 2 feet	1 6
from Constantinople, 1½ foot	1 0
Támarix	
gállica L., 1½ to 2 feet	0 6
germánica L., 2 to 2½ feet	0 4
Ulex	
europæa L., fl. pleno, 6 to 12 in. (in pots)	0 6
1 to 1½ foot, do.	1 0
stricta Mackay's Catalogue of Irish Plants 6 to 12 in. (in pots)	0 6
1 to 1½ foot do.	1 0
Vélla	
Pseudo-Cytisus L., 6 in. (in pots)	1 0
Virgília	
áltea Mx., 1 foot	1 6
Viburnum	
Lentago L., 2 feet	0 9
Lantana L., 1 to 1½ foot	0 6
levigatum H. K., 1 to 1½ foot	0 9
medium Booth, 1 to 1½ foot	1 0
O'pulus L., 1 to 1½ foot	0 3
fl. pleno, 2 feet	0 9
* Vínca	
*máior L.	0 6
*mínor L.	0 4
*fol. argenteis	0 9
*fol. aureis	0 9
*fl. purpureo pleno	0 9
*fl. albo	0 9
Xanthorhiza	
apiifolia Herit., 1 foot	0 9
Yucca	
filamentosa L.	9 6
fol. var.	5 0
gloriosa L.	3 6-5 0
Xanthóxyllum	
fraxineum W., 1 foot	1 6

AMERICAN PLANTS AND SHRUBS.

1st assortment, per 100	£3 10 0
2d do.	1 10 0
3d do.	1 0 0

CLIMBING PLANTS.		Each.	Each.
<i>Those marked † are tender.</i>		s. d.	s. d.
Ampelopsis			
quinquefolia <i>Ms.</i>	-	0 6	
Aristolochia			
† sempervirens, <i>L.</i>	-	0 9	
alphi <i>Herth.</i>	-	1 6	
Atrágene			
austríaca <i>B. M.</i>	-	1 0	
americana <i>B. M.</i>	-	1 6	
Billardiára			
longifolia <i>Lab.</i>	-	1 6	
Berchémia			
volubilis <i>Dec.</i>	-	1 6	
† Bignónia			
† australis <i>R. Br.</i>	-	2 6	
† Chirac <i>Aub.</i>	-	2 0	
† grandiflora <i>Thun.</i>	-	2 0	
radicans <i>L.</i>	-	1 0	
Calámpelis			
scabra <i>D. Don</i>	-	1 0	
Caprifólum <i>R. et S.</i>			
chinéense <i>Wat.</i>	-	1 0	
Douglassii <i>Lindl.</i>	-	2 6	
flavum <i>B. M.</i>	-	1 0	
*grátum <i>R. & S.</i>	-	1 0	
Periclymenum <i>R. & S.</i>	-	0 4	
béigicum	-	0 6	
serótinum	-	0 6	
quercifóllum	-	1 0	
fol. variegátiis	-	1 6	
*sempervirens <i>R. & S.</i>	-	1 0	
*coccineum	-	1 6	
minus	-	1 6	
perfoliatum <i>Lindley</i>	-	1 0	
rubrum	-	1 0	
Celástrus			
scandens <i>L.</i>	-	0 6	
† Combrétum			
purpureum <i>Vahl</i>	-	5 0	
Clématis			
campanuliflora <i>Brot.</i>	-	2 6	
crispa <i>L.</i>	-	0 6	
Flammula <i>L.</i>	-	1 0	
montana	-	3 6	
orientalis <i>L.</i>	-	0 6	
pennsylvánica	-	0 6	
Vidua <i>L.</i>	-	0 9	
Viticélla <i>L.</i>	-	0 6	
fl. pleno	-	1 6	
*florida <i>Thun.</i>	-	1 0	
fl. pleno	-	2 0	
† Cobos'a			
scandens <i>Cav.</i>	-	1 0	
† Dólichos			
lignóseus <i>L.</i>	-	2 0	
* Gelsémium			
*sempervirens <i>H. K.</i>	-	2 6	
Glycine			
frutescens <i>L.</i>	-	1 6	
sinénsis <i>B. R.</i>	-	2 0	
* Hédera			
*Ivy (Irish broad-leaved)	-	0 3	
*Hélix <i>L.</i>	-	0 2	
Hédera			
*Hélix argentea variegata]	-	0 9	
Hibbértia			
volubilis <i>B. Rep.</i>	-	1 0	
* Jasminum			
*fráticans <i>L.</i>	-	0 9	
*humile <i>L.</i>	-	0 6	
officinále <i>L.</i>	-	0 6	
argenteum var.	-	1 6	
aureum var.	-	1 6	
*revólitum <i>B. R.</i>	-	1 6	
† Kennédyá			
† monophylla <i>Ven.</i>	-	1 6	
† rubricánda <i>Ven.</i>	-	2 0	
Lýcium			
europæum <i>L.</i>	-	0 6	
Trewiánum <i>Duh.</i>	-	1 0	
chinéense <i>Mû.</i>	-	1 6	
Lophospermum			
erubescens <i>D. Don</i>	-	1 0	
Menispermum			
canadéense <i>L.</i>	-	0 9	
Maurándya			
Barclayána <i>B. R.</i>	-	1 0	
sempervirens <i>Jac.</i>	-	1 0	
† Manéttia Mutis			
coccinea <i>W.</i>	-	1 6	
Passiflora			
cærulea <i>L.</i>	-	1 6	
racemosa	-	1 6	
† Hibbertiana <i>B. R.</i>	-	1 0	
† hybrida	-	1 6	
tedalis <i>B. M.</i>	-	1 6	
† Mayana, May of Hope Nursery	-	2 6	
Periploca			
græca <i>L.</i>	-	0 6	
† Quisquális			
† indica <i>L.</i>	-	2 6	
Rhodochiton			
volubile <i>Don.</i>	-	1 6	
Rose,			
Ayrshire	-	0 6	
double white	-	1 0	
red	-	1 0	
Spalding's red	-	1 6	
Countess of Leven	-	1 6	
Craighill seedling	-	1 6	
Dundee rambler	-	1 6	
Rúbus			
fruticosus fl. pleno <i>L.</i>	-	0 9	
fruc. albo	-	1 0	
coccineo	-	0 9	
fol. variegatis	-	1 0	
laciniatis	-	1 0	
* Smilax			
*aspera <i>L.</i>	-	1 0	
*rotundifolia <i>L.</i>	-	1 0	
Sóllya			
heterophylla <i>Lindl.</i>	-	1 6	
Tacsónia			
pinnatifida <i>J.</i>	-	3 6	
Vitis			
laebélla Booth	-	1 6	
vulpina <i>W.</i>	-	1 6	

FRUIT TREES.

A select Collection of the most approved Sorts.

Apple,			Cherry, Pear, and Plum,	
dwarf	-	0 9	dwarf	-
standard	-	1 0	standard	-
rider	-	1 6	1s. to 1 6	
dwarf, trained	-	2 6	rider	-
rider, trained	-	3 6	2s. 6d. to 3 6	
dwarf, on paradise stocks	-	1 0	dwarf, trained	-
dwarf, trained, on ditto	-	3 0	3s. 6d. to 5 0	
			Jargonelle Pear, on quince stocks,	
			dwarf	-
			1 6	

	Each. s. d.	Each. s. d.
Jargonelle Pear, on quince stocks,		
dwarf, trained	3 6	
Peach, Nectarine, and Apricot,		
dwarf	1 6	
rider	2s. 6d. to 3 0	
dwarf, trained	5s. to 7 6	
rider, trained	7s. 6d. to 10 0	
Almond,		
fruit-bearing, standard	2 0	
dwarf, trained	3s. 6d. to 5 0	
Figs,		
in sorts	1s. 6d. to 2 0	
Medlar,		
dwarf	1 0	
standard	2 6	
Mulberry,		
black, standard, 4 feet,	2s. 6d. to 5 0	
5 to 6 feet	5s. to 7 6	
rider, trained	10 6	
Nuts,		
in sorts	0 6	
Vines		3 6
Gooseberry,		
in sorts		0 3
Currants,		
in sorts		0 3
Raspberry		0 3
Cranberry		0 6
Strawberry,		
in sorts	2s. 6d. to 3 6	
Elton (ripens a fortnight to three weeks after the general crop),		per 100 7 6
Paradise Stocks,		
1 to 1½ feet,		per 100 10 0
Apple Stocks,		
1 year's seedlings,		per 1000 10 0
2 years'		do. 12 6
Pear Stocks,		
1 year's seedlings		do. 12 6
2 years'		do. 15 0

IV.

Catalogue of Hardy Trees and Shrubs cultivated for Sale in the Nursery of the Brothers BAUMANN, at Bollwyller, in the Department of the Upper Rhine, France. With the Prices for 1838.

ARBRES D'ALIGNEMENT ET D'ORNEMENT ET ARBUSTES D'AGREMENT DE PLEINE TERRE.

N. B. Les objets marqués d'une * doivent être couverts en hiver dans les contrées septentrionales; ceux marqués d'une † peuvent être fournis à haut-vents ou hautes-tiges; tous les autres ne peuvent être fournis, cette année, qu'en arbustes de différentes grandeurs. Comme il est bien des espèces de plantes ligneuses, et notamment des arbres verts, qui, après avoir été arrachés de pleine terre, ont beaucoup de peine à reprendre, les Frères BAUMANN en ont élevés en vase; ils peuvent disposer de celles marquées des lettres p. t. (en pot); la reprise en est certaine; les envois et les transplantations peuvent s'effectuer sans inconvénient presque dans toutes les saisons de l'année.

ALLEE- UND ZIER-BÄUME UND VERZIERUNGSSTRÄUCHER IN'S FREYE LAND.

N. B. Diejenigen Gegenstände, welche mit einem * bezeichnet sind, müssen in nördlichen Lagen, über Winter bedeckt werden; die mit † bezeichneten können für dieses Jahr hochstämmig, alle übrige aber nur als Sträucher verschiedener Größe abgegeben werden.

Da manche Holzgewächse, insonderheit die Nadelhölzer, wenn sie aus dem freyen Lande ausgehoben werden, nur mit vieler Mühe wiederum anwachsen, so haben Gebrüder BAUMANN dergleichen in Töpfen erzogen und können von denjenigen Sorten abgeben, die mit den Buchstaben p. t. (im Topf) bezeichnet sind; das Wiederanwachen ist damit gesichert und die Versendungen und Verpflanzungen können bald zu allen Jahreszeiten ungehindert gemacht werden.

	La Pèce.	Das Stück.	Fr.	Cent.		La Pèce.	Das Stück.	Fr.	Cent.
Acer					Æsculus				
créticum dasycarpum	-	-	1	0	Hippocastanum sôtre pléno	-	-	2	0
glabrum	-	-	1	0	foliis argenteo variegatis	-	-	1	50
laciniatum, E. lacinié	-	-	1	0	hybrida	-	-	0	80
lobatum Fisch.	-	-	1	0	macrostachya H. gen., Pavia macrostachya Herb. gen., A. spicata, p. t.	-	-	1	50
† Lobéli nov. sp.	-	-	2	0	ohioténsis, Mar. de l'Ohio	-	-	0	50
monspesulanum	-	-	1	0	Pavia Mich., Mar. d'Inde à fleurs rouges	-	-	0	80
† neapolitanum	-	-	2	0	fruticosa Herb. gen., Æs. carnea	1	1	50	
† Negundo L., E. à feuilles de Frêne	-	-	0	50					
O'palus Willd., Ex. opale	-	-	1	0	† Ailántus				
populifolium, non A. O'palus	-	-	1	0	† glandulosa Mich., Vernis du Japon Urusi	-	-	1	0
pennsylvanicum, A. spicatum Lam., A. mont.	-	-	1	0	idem, 100 jeunes replants; 100 junge Pflanzen	-	-	12	0
† Pseudo-Platanus L., E. Sycomore	-	-	1	0					
† fol. varieg. E. à feuilles panachées	-	-	1	0	A'lnus				
striatum Du Roi, E. jaspé	-	-	1	50	cordata Desf.	-	-	2	0
tataricum Lam.	-	-	1	50	laciniata, B. A'lnus laciniata	-	-	1	50
trilobum Lam.	-	-	2	0	oxycanthaefolia	-	-	3	0
* Æsculus					* Amórpha				
silva L., Æ. hites Mich.	-	-	0	80	fruticosa L., Faux Indigo	-	-	0	50
† Hippocastanum L., Marronnier d'Inde	1	1	50		glabra, 25 jeunes plantes de 2 ans; 25 2-jährige Pfl.	-	-	3	0

	La Pièce.	Des Stuck.	Fr.	Ct.
Amýgdalus				
comúnis fl. pleno, Amand. à fl. doub.	1		0	
jaspídea	1		50	
fol. variegáta	1		0	
nána L., Amandier nain	0		50	
orientális Hort. Kew., A. arg. Lam.	1		0	
pámila flore pleno, Prúnus sinénaís	1		0	
sibíríca Gmelin, A. de Sibérie	1		0	
Andrómeda				
acumináta Lin., p. t.	2		0	
arbórea Lén., p. t.	5		0	
axilláris, p. t.	1		50	
longifolia	2		0	
calyculáta L., Andr. caliculé, p. t.	1		0	
angustifolia	1		0	
caesiifolia Vent., A. speciosa Michx., p. t.	2		0	
dealbáta, var. speciosa ?, p. t.	2		0	
lúcida Jacq.	4		0	
maríana, A. du Maryland, p. t.	4		0	
paniculáta L., And. paniculé, p. t.	2		0	
polifolia L., And. à feuil. de polium, p. t.	0		50	
oleæfolia, And. à f. d'olivier, p. t.	1		50	
rosmarinifolia, A. angustif. p. t.	1		50	
pulverulenta (var. speciosa), p. t.	3		0	
racemosa L., And. à grappes, p. t.	2		0	
speciosa, A. formosíssima	3		0	
N.B. Idem, une collection de 12 espèces assorties avec noms, au choix des frères Baumann; Eine Sammlung von 12 Sorten mit Namen, nach der Wahl von Gebrüder Baumann, zu	15		0	
Anóna				
*glabra Lén., p. t.	3		0	
Arália				
*pinosa L., Aralia épineuse	3		0	
Aristolóchia				
alphi L'Hér., Aristoloche Syphon, p.t.-	1		50	
Armeniaca				
*nepalénsis, nova	2		0	
Azálea				
calendulácea, p. t.	3		0	
fúlgens, p. t.	4		0	
insignis, p. t.	3		0	
mirábilis	4		0	
major, p. t.	4		0	
hýbrida Candolle, p. t.	3		0	
frágrans, Archiduc Jean	5		0	
Buckinghamii	4		0	
Céleís	4		0	
Cornúí	4		0	
Degenfeldii	4		0	
Derní, p. t.	4		0	
Dobáyi	4		0	
Fredróí	4		0	
Marshálli, p. t.	5		0	
O'ttoí	4		0	
Sm'thii	4		0	
Sinnfií	4		0	
Spitzembérgii	4		0	
Suchorzéwakii	4		0	
Wallnérii	4		0	
Wernérii	4		0	
Zielónakii	3		0	
nudiflora aurantiaca máxima, A. aur. } máior	4		0	
aúrea variegáta, A. aurantis, p.t.	5		0	
bicolor Willd., p. t.	1		50	
coccínea aurantiaca, p. t.	5		0	
scintillans, p. t.	5		0	
cramoisié flamboyante, p. t.	4		0	
cáprea	3		0	
variegáta nova, p. t.	4		0	
globosa álba, p. t.	5		0	
grandiflora, p. t.	4		0	
sanguínea, p. t.	5		0	
Guillaume er	3		0	
Láónii	3		0	
mirábilis, p. t.	2		0	
mixta odoráta, p. t.	3		0	
pennsylvánica	3		0	
præcox, p. t.	2		0	
prolífera nána, p. t.	2		0	
supérba, p. t.	3		0	
pulchélla, p. t.	3		0	

	La Pièce.	Des Stuck.	Fr.	Ct.
Azálea				
nudiflora pámila	3		0	
purpúrea, p. t.	3		0	
rúbea	3		0	
rúbra, p. t.	3		0	
nána, p. t.	3		0	
rútilans splendíffissima	4		0	
speciosíssima, p. t.	4		0	
supérba incarnáta, p. t.	3		0	
Viola odoráta, p. t.	4		0	
coccínea, A. écarlate, p. t.	4		0	
máxima, p. t.	4		0	
gláucia L., Azálea glauque, p. t.	1		50	
coronáta, p. t.	3		0	
cáprea variegáta	3		0	
háspida, p. t.	1		50	
máxima odoráta, p. t.	4		0	
pennsylvánica, p. t.	3		0	
scábra, p. t.	3		0	
tortubosa fl. álbo pleno, p. t.	2		0	
vittáta, p. t.	2		0	
periclymenóides Michx., p. t.	2		0	
póntica lítea L., A. jaune, Az. du } Pont, p. t.	2		0	
álba	2		0	
bicolor	2		0	
crócea	3		0	
fláva	3		0	
grandiflora purpúrea	5		0	
húmilis	2		0	
jasminiflora	2		0	
montána	2		0	
ne plus últra	3		0	
quadricolor, p. t.	3		0	
tricolor, p. t.	4		0	
vittáta	3		0	
Carlowitzii	4		0	
viscôsa fissa, A. floribúnda, p. t.	3		0	
serótina	3		0	
aurantiaca	5		0	
Une collection d'azalea de 30 espèces au } choix des Frères Baumann; Eine Samm- } lung von 30 Sorten Azalea, nach der } Wahl der Gebrüder Baumann, zu } Id., 25 beaux plants en mélange; 25 } schöne Pflanzen im Rum. }	45		0	
Id., 25 beaux plants en mélange; 25 } schöne Pflanzen im Rum. }	20		0	
Bérberis				
duxifolia Lam.	4		0	
crética De Cand.	2		0	
emargináta Willd.	2		0	
sibíríca	2		0	
sinénsis	1		0	
vulgáris abortiva	1		0	
canadénsis, Ep. vin. du Can.	1		50	
violácea	1		0	
*† Bignonía				
*Cáldipa, Cáldipa springæfolia	1		1	50
Idem, 100 replants d'un an; 100 Péd. su	10		0	
*radicans L., Jasmin de Virginie	1		0	
Idem, 50 jeunes plantes; 50 junge Pflanzen	6		0	
Bórya				
acumináta Michx.	2		0	
Báxus				
baicárica	2		0	
sempervirens suffruticosa, p. t.	0		50	
suffruticosa angustifolia, p. t.	1		50	
foliis argénteo-maculáta, p. t.	1		0	
Calycánthus				
férax Herb. gen., C. glaucus	1		50	
flóridus L., Calycánthus de Virginie	1		50	
lævigátus, C. à feuilles glabres, p. t.	2		50	
nána, C. nain, p. t.	1		50	
oblongus Aiton ?	1		50	
præcox, Merátia frágrans H. gen. } Chimonánthus frágrans De } Candolle, p. t. }	4		50	
Idem 25 calycanthus en mélange; 25 } calycanthus im Rummel, su }	20		0	
Ceanóthus				
americánus L., Céan. d'Amérique, p. t.	1		0	
Id., la doux. jeunes plantes de 2 ans; } das Dts. 3-jähr. Pflanzen }	2		0	
Baumannii Spach, fl. róseo	3		0	
microphyllus Michx.	3		0	
ovátus flore cyáneo Dezfont.	3		0	

	La Pèce.	Des Stock.	Fr.	Ct.
Celastrus				
<i>scandens</i> <i>Lm.</i>	-	-	1	0
Celtis				
<i>americana</i> <i>Mill.</i>	-	-	1	50
<i>austriaca</i> <i>Lm.</i>	-	-	1	50
<i>occidentalis</i> <i>Lm.</i> , <i>C. crassifolia</i> <i>Lam.</i>	-	-	1	0
<i>occidentalis</i> <i>Lm.</i> , Micocoulier de Virginie	-	-	1	0
Cephalanthus				
<i>occidentalis</i> <i>Lm.</i>	-	-	1	0
Cercis				
<i>canadensis</i> <i>Lm.</i>	-	-	1	0
* <i>Siliquastrum</i> <i>L.</i> , Arbre de Judée	-	-	1	0
Idem, 25 plantes d'un an; 25 jährige Pflansen	-	-	3	0
<i>fibro albo</i>	-	-	1	0
Chionanthus				
<i>pubescens</i>	-	-	4	0
<i>virginica</i> <i>L.</i> , Arbre de neige	-	-	2	0
Clématis				
<i>angustifolia</i> <i>De Cand.</i>	-	-	1	0
<i>crispa</i>	-	-	1	0
<i>Flammula</i> , Clématite odorante	-	-	0	80
<i>glauca</i>	-	-	1	0
<i>integrifolia</i> , 50 plantes, 50 Pflansen	-	-	6	0
<i>maritima</i> <i>Lm.</i>	-	-	1	0
<i>orientalis</i>	-	-	1	0
<i>parviflora</i> <i>De Cand.</i>	-	-	1	50
<i>sibirica</i> <i>Spr.</i>	-	-	2	0
<i>Viorna</i>	-	-	2	0
<i>Viticella</i>	-	-	0	80
<i>fibro pleno</i> , C. à fleurs doubles	-	-	1	50
Cléthra				
<i>alnifolia</i> <i>L.</i> , Cléthra à feuil. d'aune	-	-	1	0
p. t.	-	-	1	0
<i>tomentosa</i> <i>Pursh</i>	-	-	2	0
Colutea				
<i>arborescens</i> <i>L.</i> , Bagueaudier commun	-	-	0	50
Idem, 100 replants de 2 ans; 100 2-jährige Pflansen	-	-	5	0
<i>media</i> <i>Willd.</i>	-	-	0	50
<i>orientalis</i> <i>Lam.</i>	-	-	0	50
<i>Pocockii</i> <i>Alt.</i> , <i>C. haleppica</i>	-	-	1	0
Comptonia				
<i>asplenifolia</i> <i>L'Her.</i> , p. t.	-	-	2	0
Córchorus				
<i>japonicus</i> <i>f. pleno</i> <i>H. g.</i> , Cor. du Jap.	-	-	0	50
Idem, 50 replants de 2 ans; 50 St. 2-jäh. Pfl.	-	-	2	0
* Coriaria				
<i>myrtifolia</i> <i>L.</i> , Redoul à feuil. de Myrthe	-	-	0	50
Coronilla				
<i>Emerus</i> <i>Willd.</i>	-	-	0	50
Córnus				
<i>alba</i> <i>L.</i> , Cornouiller blanc	-	-	0	50
<i>fol. variegatis</i>	-	-	1	0
<i>alternifolia</i> <i>L.</i> , C. à feuilles alternes	-	-	1	0
* <i>stórida</i> <i>L.</i> , Cor. à grandes fleurs, p. t.	-	-	1	50
<i>triacula</i> <i>L.</i> , C. male	-	-	0	50
+ <i>fructu luteo</i>	-	-	1	0
<i>paniculata</i> <i>L'Herit.</i>	-	-	0	50
<i>sibirica</i> , nov. sp.	-	-	2	0
<i>stricta</i> <i>L'Herit.</i> , C. élané	-	-	0	50
Córylus				
<i>americana</i> <i>Mich.</i> , Noisetier d'Amérique	-	-	1	50
<i>atropurpurea</i> <i>nova</i>	-	-	3	0
<i>Colurna</i> <i>L.</i> , N. de Byzance	-	-	0	50
<i>laciniata</i> <i>nova</i>	-	-	3	0
<i>rostrata</i> <i>Nois.</i> , cornu	-	-	3	0
<i>tubulosa</i> <i>Willd.</i>	-	-	0	50
Cotoneáster				
<i>affinis</i>	-	-	1	0
<i>acuminata</i>	-	-	1	0
<i>duxifolia</i>	-	-	1	50
<i>frigida</i> <i>nova</i>	-	-	2	0
<i>maxiflora</i>	-	-	1	50
<i>racemiflora</i> <i>Spreng.</i>	-	-	2	0
<i>vulgaris</i> <i>Link.</i>	-	-	1	0
Crataegus				
<i>acuminata</i>	-	-	1	0
* <i>Azardus</i> <i>L.</i> , Néf. azérolier ou de Nsp.	-	-	1	0

	La Pèce.	Des Stock.	Fr.	Ct.
Crataegus				
<i>Azardus</i> <i>Arbónia</i> , Azérolier d'orient	-	-	1	0
<i>Celastrus</i> <i>Bosc</i>	-	-	1	0
<i>coccinea</i> <i>Willd.</i> , Néflier écarlat	-	-	0	50
<i>corallina</i> , <i>C. coccifolia</i> , <i>Mesp. Phenopyr.</i>	-	-	0	50
<i>Crus-galli</i> <i>Willd.</i> , <i>Mespilus ibida</i> <i>Erk.</i>	-	-	0	50
<i>media</i> , <i>C. lucida media</i>	-	-	0	50
<i>splendens</i>	-	-	0	80
<i>elliptica</i> <i>Ad.</i>	-	-	1	0
<i>glabra</i> <i>Thunb.</i>	-	-	2	0
<i>glandulosa</i> <i>Marné</i> , <i>C. rotundifolia</i>	-	-	0	50
<i>lucida latifolia</i>	-	-	1	0
<i>mexicana nova</i>	-	-	2	0
<i>monogyna</i> <i>fibro rubro</i> <i>Willd.</i>	-	-	1	0
<i>odorata</i>	-	-	1	50
<i>orientalis</i> <i>Spreng.</i>	-	-	1	50
<i>Oxyacantha</i> <i>fibro pleno albo</i>	-	-	1	0
<i>foliis variegatis</i> , Aube-épine à feuil. p. t.	-	-	1	0
<i>tanacetifolia</i> <i>Poir.</i> , Néf. à feuilles de Tanaisie	-	-	1	50
<i>axillaris</i> , <i>M. xanthocarpus</i>	-	-	1	50
<i>uniflora</i>	-	-	1	50
Cupressus				
<i>disticha</i> <i>L.</i> , Cyprès chauve, (arbre unique pour être planté dans l'eau; einzig zu Wasserpfanzungen.) p. t.	-	-	1	2
<i>thyoides</i> , Faux thuya, p. t.	-	-	1	50
* Cydonia				
* <i>sinensis</i> <i>Herb. gen.</i>	-	-	1	0
Cytisus				
<i>biflorus</i>	-	-	0	50
<i>argenteus</i>	-	-	1	50
<i>elongatus</i> <i>Willd.</i>	-	-	1	0
<i>hirtatus</i> <i>L.</i> , Cytise hérissé	-	-	0	50
<i>Labrum</i> <i>L.</i> , Cytise des Alpes	-	-	0	50
Idem, 100 plants; 100 junge Pflansen	-	-	5	0
<i>inclum</i> , <i>C. quercifolius</i>	-	-	2	0
<i>latifolium</i>	-	-	1	0
<i>monstrum</i>	-	-	1	50
<i>pendulum</i>	-	-	1	50
<i>sensifolium</i>	-	-	2	0
<i>nigricans</i>	-	-	0	50
Idem, 25 jeunes plantes; 25 junge Pflansen	-	-	3	0
<i>purpureus</i> <i>Willd.</i> , Cytise à fl. pourpres	-	-	0	50
Idem, 25 replants de 2 ans; 25 St. 2-jäh. Pfl.	-	-	3	0
<i>Pa.</i>	-	-	0	50
<i>sesilifolius</i> <i>Lm.</i>	-	-	0	50
* Daphne				
<i>Lauréola</i> <i>Willd.</i>	-	-	0	50
<i>Meureux</i> <i>L.</i> , Bois gentil	-	-	0	50
Idem, 12 replants; 12 Setzlinge	-	-	3	0
<i>fibro albo</i>	-	-	1	50
Diospyros				
<i>Lotus</i> <i>L.</i> , Plaqueminier lotus	-	-	1	0
Idem, 25 jeunes plants; 25 junge Pflansen	-	-	3	0
<i>lucida</i>	-	-	3	0
<i>virginiana</i> <i>Lm.</i>	-	-	1	0
Elaéagnus				
<i>angustifolia</i> <i>L.</i> , Olivier de Bobême	-	-	1	0
E'mpetrum				
<i>nigrum</i> , E. à fruit noir, p. t.	-	-	1	50
* Erica				
<i>cinéras</i> , p. t.	-	-	1	50
Euónymus				
<i>angustifolius</i>	-	-	1	50
<i>atropurpureus</i>	-	-	1	0
<i>europaeus</i> <i>fol. variegatis</i>	-	-	0	50
<i>fructu albo</i>	-	-	0	50
<i>Hamiltonianus</i> , <i>nova</i>	-	-	3	0
<i>latifolius</i>	-	-	1	50
<i>nepalensis</i> <i>foliis variegatis</i>	-	-	3	0
<i>jaspidés</i> , <i>nova</i>	-	-	3	0
<i>verrucosus</i> <i>Scop.</i>	-	-	1	0
Fagus				
<i>asplenifolia</i> , Hêtre à feuil. d'Asplen, p. t.	-	-	2	0
<i>atropurpurea</i> , Hêtre pourpre, p. t.	-	-	2	3
<i>Castanea</i> <i>foliis argenteo-variegatis</i>	-	-	5	0
<i>crisata</i> , <i>F. incisa</i> , p. t.	-	-	3	0
<i>ferruginea</i> <i>Ad.</i> , <i>F. taxifolia</i>	-	-	3	0
<i>pendula</i>	-	-	3	0

	La Pièce.	Das Stuck.	Fr.	Ct.
Fagus				
<i>sylvatica</i> fol. variegatis	-	2	50	
Fontanèsia				
<i>hillyreoides</i> <i>Billard.</i> , Font. à f. de sil.	0	50		
F. raxinus				
<i>calabriensis</i> , nov. sp.	-	1	50	
<i>caroliniana</i> <i>Willd.</i>	-	1	0	
<i>caroliniana</i> <i>Bosc</i>	-	1	0	
<i>intermedia</i> <i>Michx.</i>	-	1	0	
<i>excelsior</i> <i>atrea</i> , Fr. lutea	-	1	0	
<i>crispa</i> <i>L.</i> , F. atrovirens	-	0	50	
<i>jaspidica</i> , Frêne jaspe	-	1	0	
<i>pendula</i> , Frêne à parasol	-	1	50	
<i>salicifolia</i> , F. ex. crbaa, F. à } feuilles de saul	-	1	0	
<i>variegata</i>	-	1	0	
<i>expansa</i>	-	1	0	
<i>juglandifolia</i> <i>Lam.</i>	-	1	0	
<i>lancea</i> <i>Bosc</i>	-	1	0	
<i>microphylla</i> rotundifolia	-	1	50	
<i>monophylla</i> , F. heterophylla <i>Vahl</i>	-	0	50	
<i>microphylla</i>	-	0	50	
<i>nana</i> <i>Willd.</i> , Frêne nain	-	0	50	
<i>nova</i> <i>Anglorum</i>	-	1	0	
<i>nlgra</i> , <i>Fraxinus pubescens</i> <i>Willd.</i>	-	1	0	
<i>O'rnus</i> florifera	-	1	0	
<i>ovata</i> <i>Bosc</i>	-	1	0	
<i>oxyphylla</i> , F. oxycarpa <i>Willd.</i>	-	1	0	
<i>pannosa</i> <i>Bosc</i>	-	1	0	
<i>polycarpa</i> <i>Willd.</i>	-	1	50	
<i>quadrangulata</i> <i>Michx.</i>	-	4	0	
<i>Richardi</i> <i>Bosc</i>	-	1	0	
<i>sambucifolia</i> <i>Willd.</i> , Fra. excelsior div.	-	1	0	
<i>sinensis</i>	-	1	50	
Gaultheria				
<i>procumbens</i>	-	2	0	
<i>Shallou</i> <i>Pursh</i>	-	3	0	
Genista				
<i>anglica</i> <i>Lin.</i>	-	1	0	
<i>candicans</i>	-	1	0	
<i>germanica</i>	-	0	50	
<i>inifolia</i> <i>Lin.</i>	-	1	0	
<i>lusitana</i> <i>Lin.</i>	-	1	0	
<i>ovata</i> <i>Waldstein</i>	-	2	0	
<i>tinctoria</i> <i>sibirica</i> , G. de Sibérie	-	0	50	
† Ginkgo				
<i>foliosa</i> <i>L.</i> , <i>Sallabaria</i> <i>edantif. Smith</i> 5 à 10	0			
† Gleditschia				
<i>macracanthos</i> , Fèv. à grosses épines	-	1	50	
<i>monosperma</i> <i>Walt.</i>	-	2	0	
<i>triacanthos</i> <i>L.</i> , Fèvier à trois pointes	-	1	0	
<i>inermis</i> , G. la'vis, Fèv. sans épines	-	1	50	
Glycine				
<i>frutescens</i> <i>L.</i> , Glycine arbrisseau	-	1	50	
<i>sinensis</i> <i>Bot. Mag.</i>	-	3	0	
Gordonia				
<i>pubescens</i> <i>Herb. gen.</i> , p. t.	-	4	0	
† Guilandina				
<i>dioca</i> <i>L.</i> , <i>Gymnocladus canad. Lam.</i>	-	1	50	
Halèsia				
<i>diptera</i>	-	3	0	
<i>tetraptera</i> <i>L.</i> , Halèsia à quatre ailes, p. t.	-	2	0	
<i>parviflora</i> <i>Michx.</i>	-	5	0	
Hédéra				
<i>Hélix</i> , fol. variegatis, p. t.	-	1	50	
<i>hibernica</i> , p. t.	-	1	50	
<i>quinquefolia</i> <i>L.</i> , <i>Cissus</i> , quinq. } Vigne vierge	-	0	30	
• Hibiscus				
<i>syriacus</i> <i>L.</i> , Mauve en arbre	-	1	50	
Idem, 100 plants d'un an; 100 jährlige } Pflansen	-	6	0	
• Sore albo pleno	-	2	0	
• Sore rubro pleno	-	2	0	
• Sore violaceo	-	1	50	
• Sore violaceo pleno	-	2	0	
Hippophae				
<i>argentea</i> <i>Pursh</i>	-	2	0	
<i>canadensis</i> <i>Lin.</i>	-	3	0	
<i>rhamnoides</i> <i>L.</i> , Argousier rhamnoidé	-	0	50	

	La Pièce.	Das Stuck.	Fr.	Ct.
Hydrangea				
<i>arborescens</i> <i>L.</i> , Hydrangea en arbre	-	0	80	
Idem, 12 reptants; 12 Setzlinge	-	3	0	
Hypéricum				
<i>Androssimum</i>	-	0	50	
<i>calycinum</i>	-	1	0	
<i>hircinum</i> <i>L.</i> , Mil. fétide	-	0	50	
<i>prolificum</i> <i>Lin.</i>	-	0	50	
12 plants; 12 jährige Pflansen	-	1	50	
• Jasminum				
<i>fruticans</i> <i>L.</i> , Jasmin à f. de cytise, p. t.	-	0	50	
<i>humile</i> <i>L.</i> , J. d'Italie, p. t.	-	0	50	
<i>officinale</i>	-	1	0	
† Ilex				
<i>Aquifolium</i> <i>L.</i> , Houx commun, p. t.	-	1	0	
<i>foliis albo-maculatis</i> , p. t.	-	3	0	
<i>argenteis</i> variegatis	-	3	0	
<i>aureo-maculatis</i>	-	3	0	
<i>aureo-variegatis</i>	-	3	0	
<i>laurifolium</i>	-	3	0	
<i>balearica</i> <i>Desfont.</i> , p. t.	-	3	0	
<i>echinata</i> , <i>I. Aquifolium</i> ferox, p. t.	-	3	0	
<i>argenteo-variegata</i>	-	3	0	
<i>aureo-variegata</i>	-	6	0	
<i>pectinata</i> , nov. var.	-	5	0	
<i>recurva</i>	-	5	0	
<i>serrata</i> , <i>I. ciliata</i> , p. t.	-	3	0	
Juglans				
<i>cathartica</i> <i>Michx.</i> , N. cendr.	-	1	50	
<i>straxinifolia</i>	-	3	0	
<i>nlgra</i> <i>Less.</i> , Noyer noir d'Amérique	-	1	50	
Idem, 25 plants d'un an; 25 jährige Pfl.	-	3	0	
<i>oliveformis</i> , Pacane nut, Hickory	-	2	0	
<i>pyriformis</i>	-	2	0	
• Juniperus				
<i>daurica</i>	-	5	0	
<i>Oxycedrus</i> <i>Lin.</i> , p. t.	-	3	0	
<i>phoenicea</i> <i>Lin.</i> , Génév. de Phénicie, p. t.	-	3	0	
<i>prostrata</i> <i>Michx.</i> , p. t.	-	2	0	
<i>recurvata</i>	-	5	0	
<i>Sabina</i> fol. variegatis, p. t.	-	1	50	
<i>suecica</i> <i>Müller</i> , masc. mâle, p. t.	-	2	0	
<i>form. femelle</i> , p. t.	-	2	0	
<i>taurica</i> , nov. sp., p. t.	-	5	0	
<i>thurifera</i> , Génév. à l'encens, p. t.	-	3	0	
<i>virginiana</i> , Cèdre de Virginie, p. t.	-	1	0	
Kalmia				
<i>angustifolia</i> <i>L.</i> , <i>Kalmia</i> à ft. étroites, p. t.	-	2	0	
<i>fol. marginato-argenteis</i>	-	5	0	
<i>nitida</i>	-	4	0	
<i>rubra</i>	-	4	0	
<i>glauca</i> <i>Willd.</i> , <i>Kalmia</i> glauque, p. t.	-	3	0	
<i>latifolia</i> <i>Herb. g.</i> , <i>Kalmia</i> à larges f., p. t.	-	2	0	
Idem, 25 jeunes plants de 2 ans; 25 junge } 2-jährige Pflansen	-	12	0	
• Kœlreutéria				
<i>paniculata</i> <i>L'H.</i> , Sapind. chin. <i>L.</i> , p. t.	-	1	0	
• Laurus				
<i>Benadix</i> <i>L.</i> , Faux Benjoin, p. t.	-	2	0	
<i>carolinensis</i> <i>Pursh</i> , p. t.	-	2	0	
<i>Sassafras</i> <i>L.</i> , Laurier sassafras, p. t.	-	2	50	
• Lèdum				
<i>palustre</i> <i>angustifolium</i>	-	1	50	
<i>latifolium</i> <i>Herb.</i>	-	2	0	
Ligustrum				
<i>ulgare</i> fructu albo	-	0	50	
<i>fructu viride</i>	-	1	0	
Liquidambar				
<i>styraciflua</i> <i>L.</i> , Copalme d'Am., p. t.	-	2	50	
† Liriodèndron				
<i>Tulipifera</i> , <i>L.</i> , Tulipier de Virginie de } 6 à 9 pieds de hauteur; von 6 bis 9 } Schuh Höhe, das Stuck	-	2 à 3	50	
Le même élevé en pot, dont la reprise } est certaine; der nämliche im Topf } erzogen	-	1	50	
<i>Tulipifera integrifolia</i> , T. à feuil. en- } tières	-	4	0	
Lonicera				
<i>caprifolium</i> <i>L.</i> , Chèvre feuille des Jard.	-	0	50	
<i>chinensis</i> <i>De Cand.</i>	-	3	0	

	La Plâce.	Des Stock.	Fr.	Ct.
Lonicera				
Diervilla L., Diervilla jaune	-	-	0	50
à va De Candolle	-	-	1	50
grata L., Periclymenum bélicum Willd.	-	-	1	0
Schöne Lonicera	-	-	1	50
ibérica	-	-	1	50
noira Lm.	-	-	0	50
Periclymenum quercifolium foliis variegatis	-	-	0	50
pyrenáica fl. rubro L., Chèv. des Pyrénées	-	-	0	50
sempervirens Willd., Chèvref. toujours vert	-	-	0	50
à fleurs rouges	-	-	0	50
coccinea, Ch. touj. vert. à fl.	-	-	1	50
scarlates	-	-	0	50
symphoricarpos L., Symphorine	-	-	0	50
tatáríca fibre rubro	-	-	0	50
xylocarpa nova L., leucocarpa	-	-	1	0
Lycium				
europæum L., Lycium d'Europe	-	-	0	30
Maclura				
aurantiaca, Broussonétia tinctoria Kunth	-	-	3	0
Magnolia				
acuminata L., Mag. à feuil. aigues, p. t.	-	-	1 à 6	0
máxima, p. t.	-	-	8	0
Alexandrina	-	-	25	0
auriculata Mich., Magnol. auriculé, p. t.	-	-	15	0
pyramidata, p. t.	-	-	15	0
cordata Mich., Cucumber Tree, p. t.	-	-	4	0
discolor	-	-	1 à 5	0
glauca, Arbre du Castor, p. t.	-	-	1 à 5	0
macrophylla Mich., p. t.	-	-	35	0
purpurea	-	-	5	0
Soulangéana	-	-	6	0
Thompsoniana, nov., p. t.	-	-	2 à 5	0
tripetala L., Magn. Ombrélla, Herb.	-	-	2 à 5	0
G., p. t.	-	-	2	5
Yates Des Fontaines	-	-	6	0
Melia				
Asedarach Lin.	-	-	0	50
Ménispermum				
canadense L., Ménisperme du Can.	-	-	0	50
Mespilus				
axillaris	-	-	1	50
Amelanchier longifolia	-	-	1	0
canadensis	-	-	1	0
Chamaemespilus L.	-	-	1	0
fissa Poirét	-	-	1	0
flabellata Bosc	-	-	1	0
germanica minor	-	-	1	0
grandiflora Aiton	-	-	1	0
oliviformis	-	-	1	0
pentagyna Sprengel	-	-	1	0
*Pyracantha	-	-	1	0
stipulacea	-	-	1	50
Mitchella				
repens Willd. p. t.	-	-	2	0
Morus				
alba L., Murier blanc	-	-	1	50
Idem, 100 replants d'un an; 100 St.	-	-	6	0
Jähr. Pflanzen	-	-	3	0
hispanica, 25 plants, 25 Setzlinge	-	-	3	0
cochleata, M. p. cochleata	-	-	2	0
constantinopolitana	-	-	3	0
multicaulis, nov. spe.	-	-	1 à 2	0
papyrifera L., Broussonétia papyrifera Vent.	-	-	1	0
rubra Lin.	-	-	3	0
tatáríca, Murier de la Tartarie	-	-	1	50
Myrica				
cerifera L., Cirier de la Louisiane, p. t.	-	-	1	50
Idem, 12 replants; 12 versetete Pflanzen	-	-	3	0
Nýssa				
bisifera Pursh	-	-	2	0
*grandidentata, Large Tupelo, p. t.	-	-	1	50
*sylvatica, N. montana hortulanorum	-	-	1	3
*villosa	-	-	2	0
Ononis				
fruticosa Willd.	-	-	0	50

	La Plâce.	Des Stock.	Fr.	Ct.
Périlpoca				
græca L., Périlpoca grèce	-	-	1	60
Philadelphus				
coronarius L., Syringa	-	-	0	30
coronarius fl. semi-pleno	-	-	1	50
gracilis De Cand.	-	-	1	50
inodorus L., Syringa sans odeur	-	-	0	80
nanus var., Ph. coronarius, Syria. nain	-	-	0	50
pubescens	-	-	1	50
Pinus				
Abies L., Picea rubra Du Roi, L'Epicea	-	-	0	60
Idem, 100 plants repiqués de 3 ans; das	-	-	15	0
100 3-jährige verpflanzte	-	-	15	0
alba Mill., Sapinette argentée, p. t.	-	-	1	0
balsamea, Baumier de Gilead, p. t.	-	-	1 à 2	0
Banksiana Willd., P. rupetris Mich. p. t.	-	-	3	0
canadensis, Hemlock Spruce, p. t.	-	-	2 à 3	0
Cedrus L., Cèdre du Liban, Sederrichte, p. t.	-	-	2 à 5	0
Idem, 25 plants repiqués d'un an; 25 verpflanzte einjährige, zu	-	-	10	0
Cembra Lin., p. t.	-	-	1 à 2	0
Cianbrasiliana, p. t., petit, klein	-	-	4	0
Deodora, Abies Moritaga, petit, klein	-	-	6	0
excelsa nova sp., petit, klein	-	-	6	0
Douglasii, nova sp., petit, klein	-	-	25	0
Fraseri, p. t.	-	-	3	0
*halepensis Willd., Pin de Jérusal., p. t.	-	-	1	50
hops Mich.; Jersey pine, p. t.	-	-	1	50
lancoolata, Bellis jaculifolia, p. t.	-	-	2 à 4	0
Laricio, Pin laricio, P. de Corse, p. t.	-	-	1	0
Larix L., Mélèze, Lerchenfichte, p. t.	-	-	0	50
maritima Willd., Pin Bordeaux, p. t.	-	-	1	0
Id., 25 replants repiqués de 3 ans; 25 dreijährige verpflanzte, zu	-	-	4	0
mitis Mich., p. t.	-	-	2	0
*montariensis, P. adunca Bosc, petit, p. t.	-	-	6	0
Mughus W., P. montana, Bergfichte, p. t.	-	-	1	0
noira Aiton, p. t.	-	-	2	0
péndula, P. Larix péndula Willd., p. t.	-	-	2	0
Picea	-	-	0	80
cinerea, p. t., petit, klein	-	-	4	0
pumilio Willd., Krummholz-Fichte, p. t.	-	-	1	50
pingens Mich., p. t.	-	-	3	0
resinosa, p. t.	-	-	1	50
rigida Willd., p. t.	-	-	1	50
serotina Mich. p. t.	-	-	1	50
Strobilus, Pin du Lord Weimouth, p. t.	-	-	1 à 2	0
taurica, nov. sp., petit, klein	-	-	3	0
sylvestris, Pin d'Esagenau, P. de Riga, p. t.	-	-	0	60
Turca, Pin d'encens, p. t.	-	-	3	0
Plus la collection de Pins et Sapins, de 25 espèces élevés en pots, au choix des frères Baumann; Eine Sammlung von 25 Sorten in Töpfe erzogenen Tannenarten nach der Wahl der Gebrüder Baumann	-	-	40	0
Plus le 100 différents pins élevés en pots, mélangés; Mehr 100 verschiedene in Töpfen erzogenen Tannenarten untereinander	-	-	60	0
N. B. Le repicage de jeunes arbres verdis est de la plus haute importance, parceque des sujets repiqués paraissent, par ce procédé, obtenir une autre nature formée à faciliter la reprise certaine; elle est assurée à tous, sauf les accidents imprévus qui seuls peuvent causer leur perte, tandis que les sujets non repiqués ne réussissent que rarement, lorsqu'ils ne sont favorisés par un tems extraordinaire.				
Das Verpflanzen der jungen Nadelhölzer ist für's Wiederauwachen von höchster Wichtigkeit, denn die verseteten Pflanzen scheinen dadurch in eine andere Natur, zum Wiederauwachen geneigt, verwandelt zu werden; ihr Gedeihen wird dadurch gesichert und nur nicht vorausgehene Zufälle thun solches hindern, während, bald alle, nicht versetzte Nadelhölzerpflanzen, nur bei einer ganz besonders günstigen Witterung, sehr selten wiederum annehmen.				

	La Piece.	Des Stock.	Fr.	Ct.
Plánera				
Richardi	-	-	1	50
simifolia	-	-	1	0
Plátanus				
cuneata Willd.	-	-	3	0
†macrophylla	-	-	3	0
†occidentális L., Platane d'occident	-1	1	50	
†orientális, P. d'Orient	-	-	1	50
† Pópulus				
álba L., l'Yprésu	-	-	1	0
argentea, P. heterophylla Michx.	-	-	1	50
balsamifera Lin.	-	-	1	0
†canadensis Michx., P. du Canada	-	-	1	0
cándicans All., var. Pópulus balsamifera	-	-	0	60
carolinensis, Pópulus angulata, Willd.	-	-	1	0
græca Willd., Peuplier d'Athènes	-	-	1	0
grandidentata, P. trépida Willd., P. agr.	-	-	2	0
hudsónica Michx., P. betulifolia, Ameri-	-	-	1	0
can black Poplar	-	-	1	0
italica dilatata Willd., Peuplier d'Italie	0	50	60	
lewigata Ait.	-	-	1	50
†marylándica, nova species	-	-	1	50
ontariensis	-	-	2	0
suaucolens, nov. spec.	-	-	3	0
Potentilla				
fruticosa L., Potentille arbrisseau	-	-	0	50
Prinos				
glaber L., Prinos lisse, p. t.	-	-	2	0
Prúnus				
acuminata	-	-	1	50
avium flore pleno, Merisier à fl. doubl.	-	-	1	0
brigantina Willd.	-	-	1	0
caroliniana, P. de Caroline, p. t.	-	-	2	0
Cerasus fl. pleno	-	-	0	80
Chamaecerasus Willd., Cerisier de St.	-	-	1	0
berrie	-	-	1	0
Coccolius De Cand.	-	-	1	50
domestica foliis variegatis	-	-	2	0
†flore pleno, Prunier à fleurs doubles	-	-	2	0
græca	-	-	2	0
incana, Amygdalus incana	-	-	2	0
*Laurocerasus L., Laurier amandier, p. t.	-	-	1	50
*lusitánica L., Ceris. Laur. de Portu-	-	-	1	50
gal, p. t.	-	-	1	50
Mahaleb L., Arbre de St. Lucie	-	-	0	50
nigra fl. pleno, Prunelle à fleurs doubles	-	-	1	50
Párus bracteata De Candoile	-	-	1	50
rubra, Merisier à grappes rouges	-	-	0	50
Idem, 25 jeunes plantes; 25 Junge Pflanzen	-	-	2	0
pumila Michx.	-	-	1	0
pygmaea Willd.	-	-	2	0
reclinata	-	-	1	50
serotina Willd., Prunier tardif	-	-	1	0
susquehana De Cand.	-	-	1	50
Ptelea				
trifoliata, 100 de 4 ans, 100 4-jährige	-	-	15	0
Pýrus				
Amelanchier W., Mésplis Amelanchier	-	-	0	50
Ehr.	-	-	0	50
angustifolia Willd., Malus sempervirens	-	-	1	0
Decand., ?atrovirens	-	-	0	50
arbutifolia nigra, M. arb. nigra	-	-	0	50
Aria Willd., Sorbus Aria, Crat. Aria	-	-	1	50
rotundifolia	-	-	1	0
suecica	-	-	1	0
baccata L., Pommier baccifère	-	-	0	50
communis flore pleno, Poirier à fl. doubles	-	-	0	50
communis fol. variegatis	-	-	1	0
coronaria, Pommier odorant	-	-	1	0
edulis Willd., Crataegus edulis Loddiges	-	-	1	0
elaeagnifolia Pallas	-	-	2	0
græca	-	-	1	0
hybrida	-	-	1	0
intermedia Willd., Py. hybrida Wendl.	-	-	1	0
*japónica fl. rubro	-	-	2	50
†flore albo	-	-	2	50
Malus foliis variegato-marginatis, P. à	-	-	1	0
l. pan.	-	-	1	0
melanocarpa Willd.	-	-	1	0
Michauxii nov. spec.	-	-	1	50

	La Piece.	Des Stock.	Fr.	Ct.
Pýrus				
microcarpa	-	-	1	50
montis Sinai, Poirier du mont Sinai	-	-	1	0
nepalensis	-	-	1	50
nivâris Willd., Poirier blanc de neige	-	-	1	50
odorata	-	-	1	0
Pollveris Willd., P. boliviariana De C.	-	-	1	0
præcox	-	-	1	0
prunifolia, Pfäumenblättrige Birne	-	-	1	50
salicifolia Willd., Poirier à feuilles de saule	-	-	1	0
salvifolia	-	-	1	50
spectabilis flore pleno	-	-	1	0
terminalis, Crat. terminalis Lin.	-	-	1	0
Quercus				
Ægilops Lin.	-	-	2	0
austraca Willd.	-	-	1	0
Ballota Desfont., Chêne d'Espagne	-	-	3	0
Banisteri Michx., Bear's Oak	-	-	1	0
Idem, 25 plants, 25 Pflanzen	-	-	4	0
Castanea Willd.	-	-	2	0
Cerris Lin.	-	-	2	0
cinerea Michx.	-	-	4	0
coccinea	-	-	2	50
conferta, Q. confertifolia H. et B.	-	-	1	0
discolor Willd., Plant de 2 ans; 2-jähr.	-	-	1	0
Pflanzen	-	-	4	0
ferruginea	-	-	4	0
heterophylla	-	-	4	0
imbricaria Michx.	-	-	5	0
lacinata, nov. spec.	-	-	10	0
macrocarpa Michx.	-	-	4	0
palæstria Michx., Quér. palæstria, Pine Oak	-	-	1	0
Phellos Michx., Willow Oak	-	-	2	0
Prinus, Chesnut-leaved Oak	-	-	1	50
Prinus discolor Michx., Swamp white Oak	-	-	1	0
monticola	-	-	2	0
tomentosa Michx., Q. bicolor Willd.	-	-	2	0
pyramidalis	-	-	1	0
Robur macrocarpum	-	-	2	0
macrophyllum	-	-	3	0
fol. variegatis	-	-	2	0
rubra montana Michx., Ch. rouge des mont.	-	-	1	0
tinctoria Michx., Quercitron, Farber-	-	-	2	0
Eiche	-	-	2	0
Idem, une collection de 15 espèces de	-	-	20	0
Quercus (Chêne) avec noms au	-	-	20	0
choix des Frères Baumann; Eine	-	-	20	0
Sammlung von 15 Sorten Quercus,	-	-	20	0
nach der Wahl der Gebrüder Bau-	-	-	20	0
mann	-	-	20	0
Rhamnus				
Alaternus	-	-	1	50
canadensis	-	-	1	50
infectorius Lin.	-	-	1	0
*latifolius L'Herit.	-	-	1	0
Rhododéndron				
azaleoides	-	-	2	0
fl. albo odorato	-	-	3	0
Catesbeii Lod.	-	-	5	0
*caucasoides, nov. spec., p. t.	-	-	3	0
Chamaecistus Lin., petit, klein	-	-	15	0
dauricum Willd., p. t.	-	-	3	0
ferrugineum roseum	-	-	2	0
hirabutum De Cand., p. t.	-	-	3	0
hybridum roseum	-	-	3	0
magnoliifolium, p. t.	-	-	4	0
máximum	-	-	3	0
Idem, 25 replants de 2 ans; 25 2-jähr.	-	-	10	0
Pflanzen	-	-	10	0
Idem, 25 plants de 3 ans; 25 3-jähr.	-	-	15	0
Pflanzen	-	-	15	0
flore roseo carnosino, p. t.	-	-	4	0
máximum, flore albo	-	-	5	0
*serifolium, nov.	-	-	5	0
pónticum	-	-	1	5
Idem, la douzaine replants de 3 ans;	-	-	5	0
das dutzend 3 jähriger Pflanzen	-	-	5	0
Idem, le 100 replants de 3 ans; 100 3-jähr.	-	-	35	0
rige Pflanzen	-	-	35	0
Le 1000 replants de 3 ans; das 1000	-	-	270	0
3-jährige Pflanzen	-	-	270	0
pónticum coronatum	-	-	5	0
flore pleno, p. t.	-	-	4	0
flore purpureo	-	-	3	0

	La Pièce.	Des Stack.	Fr.	Ct.
Rhododéndron				
*ponticum latifolium, p. t.	-	-	2	0
miniátum, p. t.	-	-	2	50
*pulverulentum, R. maculátum ang. p. t.	-	-	3	0
*punctátum, Rhod. punctu. p. t.	-	-	3	0
*solandrefolium, nov., p. t.	-	-	12	0
N. B. Les Rhododéndron en boutons coutent un quart de plus. Die Rhododéndron mit Knospen kosten ein Quart mehr.				
Idem, nne collection de 15 espéces de Rhododéndron avec noms, au choix des fréres Baumann; Eine Samm. lang von 15 Sorten Rhododéndron mit Namen, nach der Wahl der Gebrüder Baumann, su			36	0
Rhodóra				
canadénsis L., R. du Canada, p. t.	-	-	3	0
Rhús				
copállina L., Sumac ailé	-	-	1	0
Idem, 12 replants de 2 ans; 12 2-jähr. Pfl.	-	-	4	0
Córinus L., Sumac fustet	-	-	1	0
Idem, 25 plants, 25 Pflansen	-	-	6	0
élegans Willd.	-	-	1	0
Toxicodéndron L., Sumac vénéneux	-	-	1	50
typhina L., Sumac de Virginie	-	-	0	50
vénix	-	-	1	0
Idem, 25 replants de 2 ans; 25 2-jähr. Pflansen	-	-	6	0
Ribes				
átro-sanguineum novum, Chrysobó-tryum intermédiúm Spach			4	0
átreum fructu-globuloso Herb. gen.			0	50
biflórum	-	-	1	0
coctineum novum, R. purpúreum	-	-	4	0
diacanthum, R. Diacantha Willd.	-	-	0	50
Sóridum Willd., Gross. de Pennsylvanie	-	-	0	50
nigrum variegátum, Gross. noir panache	-	-	0	50
palmátum fructu-oblongo Desf., Chry-sobótryum revolutum Spach			1	0
rigens Ræmer	-	-	1	0
saxatile Fall.	-	-	1	0
speciebaum novum	-	-	3	0
triflórum Pursh	-	-	0	50
Robinia				
Altagéa	-	-	1	0
áncoropholia	-	-	1	0
Caragáa L., Robinier de Sibérie	-	-	0	50
grandiflóra	-	-	0	50
Chémilaga Willd., Rob. de la Chine	-	-	1	0
fidúbia, R. viscosa hybrida	-	-	1	50
férox, R. spinosa	-	-	1	0
frutescens Lín.	-	-	1	0
†Gundúmi, R. stricta, R. monstrósa	-	-	1	50
Halodéndron, R. satiné	-	-	1	50
hispida L., Acacia rose	-	-	1	0
arbórea	-	-	1	50
†inérnis, R. umbraculifera De Cass.			1	2
Acacia sans épines, Acacia-boule, Kugel-Acacién			1	2
Idem, 100 beaux haut-vents; das 100 schöne hochstämmige Kugel-Acacién			100	0
macrophylla, nov. spec.	-	-	1	50
†microphylla	-	-	1	0
*procúra	-	-	1	0
pygmaea Lín.	-	-	1	50
†Pætho-Acacia L., Robinier-acacia, Faux ac.			1	50
Idem, 100 replants d'un an; das 100 jähr. Pflansen			2	0
Idem, 100 replants de 2 ans; das 100 2-jähr. Pflansen			3	0
Idem, 1000 plants d'un an; das 1000 jähr. Pflansen			15	0
†crispa, nov. var., krausblättrige Acacia			1	50
†inérnis, R. spectábilis	-	-	1	50
†péndula	-	-	2	0
†sophorifolia, nov. spec.	-	-	1	50
spinosa	-	-	2	0
tortuosa, nova, R. tortueux	-	-	1	50

	La Pièce.	Des Stack.	Fr.	Ct.
Robinia				
†viscosa Willd., Acacia gluant	-	1 à 1	50	
alba	-	-	4	0
hórida	-	-	4	0
Surchoix des plus belles roses d'une collection, de plus d'un millier d'espéces, citées en grande partie au Rosetum Gallicum par N. Desportes. Auswahl der schönsten Soeten Rosen aus einer Sammlung von mehr als 1000 Sorten, grosentheils im Rosetum Gallicum von N. Desportes angeführt, als :-				
Rósa				
Ayrshire, fibre pléno, carnée, frés odorante			3	0
alba Belle Adélaïde, cramoisie clair	-	-	2	0
Belle Georgienne, rose carne	-	-	2	50
bouquet blanc	-	-	3	0
Duiciné double, blanche	-	-	2	0
Félicie	-	-	2	0
†Florine	-	-	3	4
Jongleur	-	-	3	0
Josephine, blanche	-	-	1	30
Josephine Beauharnois	-	-	1	0
Moscova	-	-	3	0
pompon carné	-	-	1	50
remarquable	-	-	3	0
royale blanche, changeant-violet	-	-	2	0
tombéau de Girardin, rose	-	-	3	0
alpina, var. Rosa de la Floride	-	-	2	50
bicolor, R. punicea, R. cap., R. red. yellow	-	-	2	0
bianda semipléna, Rose de la Bale de Hudson	-	-	1	50
burgúndica L., Rosa Pomponia Roseig.	-	-	0	50
centifolia L., R. à 100 pétales, f. p.	-	-	0	50
Agate, la petite, Kleine Agat-Rose			1	0
bipinnata Dupont, R. crispá, R. à f. de Cé			2	0
bullata ába, blanche	-	-	3	0
bullata, R. à feuilles de choux	-	-	2	0
cristata, rose pourpre, magnifique	-	-	4	0
fóra magna pléna	-	-	2	0
foliacée, Belle reine de Saxe, carnée	-	-	1	50
lactea múltiplex, Ros. unique, blanche	-	-	2	50
minor, R. c. minor pra'cox hol. Mándica			1	50
quercifolia, R. crenata, carnée	-	-	1	50
única carnée, Rose fausse-unique	-	-	1	50
† unique panache, fond blanc rayé, pourpre carmine			3	5
ungiculata, R. Cillet, rose tendre, Nelken-Rose			1	50
Victor Hugo	-	-	3	0
Vilmorin, R. centif. car. R. transparente			1	0
†chinénais fibre pléno, rose carminé	-	-	1	3
Augustin Lelleur, rose víf	-	-	3	0
Belle donna, blanc carné	-	-	2	0
Belle Isidore, rose	-	-	3	0
† Belle Menard, pourpre	-	-	2	4
† Bourbon Augustin	-	-	2	3
Bizarre de la Chine	-	-	3	0
Boutelaud, carnée	-	-	3	0
Carina, carminé víf	-	-	3	0
Catherine II., rose	-	-	1	0
scintilla	-	-	1	0
Darius	-	-	3	0
Duc de York	-	-	3	0
Etna	-	-	3	0
François I., cerise clair	-	-	3	0
Gloire de Guerin, pourpre veouté	-	-	4	0
gracilla	-	-	2	0
Hortense, rose	-	-	3	0
Ile de Bourbon, rose pourpre brillant	-	-	3	0
Ile de Bourbon pale	-	-	2	0
Lafayette	-	-	3	0
Marie-Thérèse, rose foncé	-	-	2	0
Neumání, rose pourpre	-	-	3	0
Palermo, pourpre	-	-	2	0
Rose de Lage, pourpre veouté	-	-	2	0
trionphe de Gaut	-	-	4	0

Rosa	La Pièce.	Des Stack.	Fr.	Ct.
*744s, R. Thé	-	-	3	0
bocage jaunâtre	-	-	4	0
Catherine II.	-	-	3	0
Dame blanche, jaunâtre	-	-	3	0
† Faquir, cramoisie pourpre	-	2 à 4	0	0
Flore	-	-	4	0
gracilis, rose pourpré	-	-	3	0
hortense	-	-	3	0
leontina	-	-	3	0
Madama	-	-	3	0
Maillard	-	-	3	0
mirabilis, rosée	-	-	4	0
Miraba	-	-	3	0
mon héritage	-	-	3	0
Moreau, rose pourpré	-	-	4	0
Palavici, rose	-	-	3	0
Reine Golconde	-	-	3	0
Roi d'Yvelot	-	-	3	0
strobilo, belle Joseph. de Liège, carn.	-	-	3	0
trionphant	-	-	2	0
Triomphe de Bollwiller, blanche,	-	2 à 4	0	0
cœur changeant carnée	-	-	3	0
Zethulbé, rose	-	-	3	0
* suimé cramoisie foncé	-	-	2	0
<i>Rosiers remontants.</i>				
damascèna, Adélaïde gros, pourpre carn.	-	-	2	0
Agate Capiomont	-	-	2	0
Arnold, Sophie	-	-	3	0
belgia, grande fleur pâle	-	-	2	0
belle Auguste, carnée	-	-	2	0
belle Elise	-	-	2	0
belle Italienne, rose	-	-	4	0
belle de Segur	-	-	3	0
belle de Vergnier	-	-	3	0
Billiard, rouge	-	-	3	0
blanche à feuilles marbrées.	-	-	3	0
Bonaparte, cerise	-	-	3	0
bullata, des quatre saisons, rose	-	-	3	0
Cartier, rose carné	-	-	2	0
Clémence d'Isaure; carminée	-	-	3	0
Corvisard, rose pourpré	-	-	2	0
Couronnée perpétuelle	-	-	3	0
Déesse Flore, blanche	-	-	2	0
Esquermes, foncée	-	-	3	0
Febvrier (Madame)	-	-	3	0
Flore perpétuelle	-	-	3	0
Foy (Comte de), grande fleur rose	-	-	3	0
Général Bertrand, rose carné	-	-	2	0
Gloire des Agates	-	-	2	0
Gloire des perpétuelles	-	-	3	0
Graine d'or, pâle	-	-	2	0
Grand Cels, carmin pourpré	-	-	3	0
Grand Manan	-	-	3	0
Grand Papa, rose violet	-	-	2	0
Henriette Boulogne	-	-	3	0
Jeanne d'Albert, rose foncé	-	-	2	0
Importante, rose carné	-	-	2	0
Josephine Antoinette	-	-	3	0
La miéne, carminée, perpétuelle	-	-	2	0
Lamarque, pourpre velouté	-	-	2	0
Latone, rose	-	-	2	0
Launay (de)	-	-	3	0
lucida plena	-	-	1	0
Madame de Stael	-	-	3	50
Madame de Tressan, rose tendre	-	-	3	0
Marguerite de Valois, pourprée	-	-	3	0
Marie Denis	-	-	3	0
menstruella sbré albo	-	-	2	0
Miroir (le)	-	-	3	0
Moderne (la)	-	-	3	0
monstrueuse, grande fleur rose	-	-	3	0
Moyse, cramoisie violet	-	-	2	0
Noël, rose	-	-	3	0
nouvelle Justine	-	-	3	0
Palmyre, rose tendre	-	2 à 3	0	0
parlissenne, grande fleur rose	-	-	2	0
perpétuelle Cuvier	-	-	4	0
† perpétuelle Philippe I.,	-	4 à 6	0	0
carminé violet	-	-	3	0
perpétuelle du Trianon	-	-	3	0
† Philippe I.	-	-	4	0
Pierre Corneille, cerise pourpre	-	-	2	0
Polette	-	-	3	0

	La Pièce.	Des Stack.	Fr.	Ct.
damascèna, pompon des 4 saisons, rose carné	-	-	2	0
Prince de Furstenberg	-	-	2	0
Provin éclatant, pourpre violet	-	-	2	0
Pulperie	-	-	3	0
Reine des perpétuelles	-	-	3	0
† Rose du Roi, carminée	-	2 à 4	0	0
Stossin	-	-	3	0
Thecal	-	-	3	0
Theophanie, rose carné	-	-	3	0
Tendresse admirable, carnée	-	-	2	0
Triomphe de Rouen, rose carné	-	-	2	0
Unique admirable, grande fleur rose	-	-	2	0
Valentine, rose carné	-	-	2	0
Vaubard	-	-	3	0
Vibert	-	-	3	0
Warwick	-	-	3	0
York et Lancaster, rose	-	-	2	0
gallica, Antiope, foncée	-	-	3	0
atropurpurea, Bizarre triomphant	-	-	1	50
belle Hermine double	-	-	2	0
belle mignonne, rose pourpré	-	-	2	0
belle de Stora	-	-	2	0
Berenice, rose pourpre violet	-	-	2	50
Casimir Perrier, carminé violet	-	-	3	0
Comte Camaldoli, f. p. pourpre carné	-	-	2	0
de la Borde, carminée	-	-	2	0
Eloïde, cramoisie clair	-	-	2	0
Etubie, carnée	-	-	2	0
Ferox	-	-	2	0
faux Wellington, carminé purpuré	-	-	3	0
Glacée (la) carnée	-	-	2	0
grande renoncule, pourpre foncé	-	-	3	0
Henri (jeune), cramoisie clair	-	-	2	0
Infante	-	-	3	0
Jenner, carnée	-	-	1	0
Jeanne Seymour	-	-	3	0
Josephine d'Hohensohlern, rose carminée	-	-	2	0
la dominante	-	-	3	0
la plus foncée des pourpres	-	-	1	0
Laonidas, rose pâle	-	-	2	0
Louis XVIII., cramoisie pâle	-	-	2	0
Miaulia, cramoisie violet	-	-	2	0
Montgolfier, rose pourpre	-	-	2	0
nigrorum, foncée	-	-	3	0
Pacha d'Egypte, pourpré violet	-	-	3	0
petit Roi de Rome	-	-	2	0
pourpre strié	-	-	2	0
Prince de Galles, rose carminé	-	-	2	0
Pyrolle, carminée	-	-	3	0
ranunculoides, pourpre violet foncé	-	-	1	0
Reine de Masulipatam	-	-	2	0
Roi de Français	-	-	3	0
Roi très-sombre, pourpre violet velouté	-	-	3	0
Stéphanie (grande duchesse)	-	-	2	0
tendre chiffonnée	-	-	2	0
ténébreuse, foncée	-	-	3	0
tigridia	-	-	3	0
tricolor, pourpre blanc et jaune	-	-	2	0
versicolor, double	-	-	3	0
† versicolor très pleine, pourpre rayé de rouge et blanc	-	3 à 4	0	0
violette de la Belgique, cerise violet	-	-	3	0
Warratah, cramoisie violet	-	-	2	0
hybrida, Adélone	-	-	3	0
adhire, carnée	-	-	2	0
Alphonse Maille, pourpre cerise	-	-	3	0
† Ancelin, cerise cendré	-	2 à 4	0	0
Astrolabe	-	-	3	0
Athalin, cramoisie pourpre	-	-	2	0
Barbet	-	-	3	0
Baumanniana, carnée	-	-	3	0
belle Arline	-	-	3	0
belle Christine, rose pâle	-	-	2	0
belle Judde, carné panaché	-	-	2	0
belle de Segue	-	-	3	0
Bequet	-	-	3	0
Bertholdi	-	-	3	0
Biss	-	-	3	0
bonne Génévieve	-	-	3	0
bonne Louise	-	-	3	0
Brennus	-	-	3	0
Camuset, grande fleur rose	-	-	2	0
candeur	-	-	3	0

	La Flèce.	Des Stuck.	Fr.	Ct.
hybrida, † Cara, foncée	-	-	3 à 4	0
Charles-Auguste	-	-	2	0
† Chastelux	-	-	3 à 4	0
† Chatellin	-	-	2 à 4	0
Cheron	-	-	3	0
Celestial	-	-	3	0
Claire Duchateau	-	-	3	0
Claude de Cressac, rose	-	-	3	0
† Comte Tavernes, rose	-	-	2 à 3	0
Colbert	-	-	3	0
† Coutard, carnée	-	-	2 à 3	0
Demoiselle anglaise, carnée	-	-	3	0
du Roi, carmin pourpre	-	-	2	0
Dupuytrin (Madame)	-	-	3	0
Duroc, carnée	-	-	3	0
Duvier	-	-	3	0
Fabre (belle) carnée	-	-	3	0
Favier, rose vive	-	-	2	0
Favorite des Dieux, rose	-	-	3	0
fleur blanche (à)	-	-	2	0
Fleurite, rose pourpre	-	-	2	0
Feodora, blanche	-	-	3	0
Foulard, rose	-	-	6	0
Floride (de la), carnée	-	-	2	0
† Garnier Pages	-	-	3 à 4	0
George III.	-	-	4	0
Gloire de Hardy, perpétuelle cerise	-	-	3	0
Gloire des hybrides	-	-	2	0
Henneguïn, rose	-	-	3	0
Horaces, pourprée	-	-	3	0
Jacques, pourpre foncé	-	-	3	0
Julie de l'ange	-	-	3	0
Kersabieck	-	-	3	0
† Las Cases	-	-	3 à 4	0
Lastenie, rose lilas	-	-	2	0
Laurea	-	-	3	0
Lisbeth	-	-	3	0
Mably, velouté pourpre	-	-	3	0
Maffai	-	-	4	0
Marchèse	-	-	4	0
Marie Tudor	-	-	3	0
† Maubach, viol. vel., foncé chan- geant	-	-	4 à 5	0
Monsieur Capan	-	-	2	0
† Nora	-	-	3 à 4	0
nuage des tempêtes, foncée	-	-	4	0
† Pallagie, pourpre	-	-	2 à 4	0
Pauline, carnée	-	-	2	0
† Pinks	-	-	3 à 4	0
ponctuée (la)	-	-	3	0
Reine des quatre saisons	-	-	3	0
† Riego	-	-	3 à 4	0
Roi des hybrides, rose carnée	-	-	3	0
rose de l'âge	-	-	3	0
St. Barthélemi, rose fouettée	-	-	3	0
Sydonie	-	-	2	0
Toilette des Roses	-	-	3	0
tricolor	-	-	3	0
Triomphe de Laffay, rose	-	-	3	0
Triomphe de Rheims	-	-	3	0
Velour épiscopal	-	-	3	0
versicolor pleine, panachée	-	-	3	0
Victor Hugo	-	-	3	0
lúcida pleine, R. luisante double	-	-	1	0
Rutea flore simplicis W., R. Eglantaria	-	-	0	50
microphylla pleine, rose	-	-	3	0
* moschata fl. pleno Ros. R. de Damas, muscade, lilas double	-	-	2	0
multiflora, Laure Davoust	-	-	3	0
muscosa fl. albo plena, R. mousseuse bl. fl. albo varieg. R. m. b. nouv. va- riété	-	-	2	0
à très grande fleur, carnea semipi- cocinea	-	-	3	0
† Blush moss rose, mousse euse	-	-	2 à 4	0
Nankin	-	-	4	0
ferugineuse, rose foncée	-	-	4	0
feuilles panachées (à), carnée	-	-	3	0
feuilles de sauge (à), carnée	-	-	3	0
Flèche (de la) R., m. gemoneiflora	-	-	3	0
fibre roseo pleno, Gefüllte Moosrose	-	-	2	0
* fibre roseo pleno, varie.	-	-	2	0
* fibre roseo-simplici, einfache	-	-	1	0
Moosrose	-	-	1	0
média	-	-	3	0
* minor, R. mousseuse pompon, r. foncé	-	-	3	0

	La Flèce.	Des Stuck.	Fr.	Ct.
muscosa, prolifère, rose carminé	-	-	3	0
remontante, muscosa menstru- alla, m. perpétuelle, Monat- moosrose	-	-	3	0
semi-double d'Angleterre	-	-	3	0
variegata plena, moua panachée	-	-	3	0
† soé-partout. Rose carminé	-	-	4 à 5	0
nepalensis fl. roseo	-	-	2	0
* Noisettiana Bon Jard., Belle-Noisette	-	-	2	0
Aimé Vibert, blanche	-	-	2	0
Blandine, blanche	-	-	3	0
Blygnet, carnée	-	-	2	0
Bobelina, pourpre foncé	-	-	2	0
Borlotte, pourpre foncé	-	-	3	0
† Bouquinville, rose violet	-	-	2 à 4	0
Catet, carmin violet	-	-	1	0
Changnagna, carnée	-	-	2	0
Chantal, rose	-	-	3	0
Chevrance (blanche)	-	-	2	0
Catherine II.	-	-	3	0
Comtesse de Frénel, carnée	-	-	2	0
Comtesse Hélène Festetics de Tolna	-	-	2	0
Dern, carnée	-	-	3	0
Desprès, rose tendre jaunâtre	-	-	10	0
Duc de Broglie	-	-	3	0
Dufrenoy, blanc carné	-	-	3	0
Foulard, rose	-	-	3	0
grandes fleurs pourpres	-	-	3	0
Koenig, carminé vif.	-	-	2	0
Ile de Bourbon, rose	-	-	2	0
Isaure, jaunâtre	-	-	3	0
jaune, mutabilis	-	-	3	0
Lady Byron, carminée	-	-	3	0
Laffay	-	-	3	0
Lamarque	-	-	3	0
Langevine, rose	-	-	2	0
Lée, rose tendre	-	-	3 à 4	0
Leopoldine d'Orléans, blanc carné	-	-	3	0
Mademoiselle Kennedi	-	-	3	0
Majestueuse, carminée	-	-	3	0
Méhin	-	-	1	0
Mélanie de Montjoie, blanc jaunâtre	-	-	2	50
Mordant	-	-	2	0
Muscate toujours fleurie, carnée	-	-	3	0
Nymphe (la) pâle	-	-	2	0
Parmi, violet clair	-	-	3	0
Printems, blanche	-	-	3	0
Roxelane, rose violet	-	-	2	0
rûbra, rose violet	-	-	2	0
Smithy, jaune	-	-	4	0
Thargille, pourpre violet	-	-	3	0
Triomphe des Noisettes, carné	-	-	3	0
pimpinellifolia flaba striata plena	-	-	3	0
albida	-	-	2	0
Amélie Streckelsen	-	-	3	0
belle inconnue	-	-	3	0
carnea, f. p., carnée	-	-	2	0
Emma Klein	-	-	3	0
Estelle semi-double, bifère	-	-	3	0
Henriette Kschlin, carnée, pleine	-	-	3	0
Hybride gracieuse	-	-	3	0
inconnue, carnée	-	-	3	0
lactea semiplena striata	-	-	2	0
Madame Jourdin	-	-	2	0
mignature	-	-	3	0
Pimpernelle rose	-	-	3	0
pourpre velouté, semi-double	-	-	3	0
Reine des pimpernelles, rose carné	-	-	2	0
rigidius, sulphurea semiplena	-	-	4	0
Suchorszawa (Comtesse de)	-	-	3	0
sulphurea plena, nora	-	-	5	0
Triphosa, globulose cœur carné	-	-	5	0
Zerbine, carnée	-	-	2	0
Zonale purpurea pallida	-	-	3	0
provinciàlia, l'abéne	-	-	3	0
Admirable broyée de rouge aimable Eleonore, cramoi- sie violet	-	-	3	0
Archevêque de Malines	-	-	4	0
Arlic, pourpre violet	-	-	2	0

Rôsa	La Pièce.	Das Stück.	Fr.	Ct.
provincialis, Barbanègre	-	-	3	0
beau carmin, rose foncé	-	-	3	0
beauté surprenante	-	-	3	0
beauté africaine, pourpre noir	-	-	5	0
velouté	-	-	5	0
† belle Arsène	-	-	3	4
† belle Vergnier	-	-	3	4
belle victoire, carminée	-	-	2	0
† Beniowski	-	-	3	4
Bishoppe, l'évêque, velouté	-	-	3	0
foncé,	-	-	3	0
boule de neige, blanche	-	-	2	0
bouquet charmant, rose	-	-	2	0
carmin amoureux, cerise	-	-	2	0
changeant	-	-	2	0
Calypso, rose, carné	-	-	3	0
Célestine, carnée	-	-	2	0
Charles Nodier	-	-	3	0
Clelie	-	-	4	0
Comtesse	-	-	3	0
Constance, Gracieuse de S.	-	-	3	0
Clerc	-	-	3	0
† Cora, cerise	-	-	3	4
Courtin, carnée	-	-	2	0
Dadigne	-	-	3	0
Danal à grandes fleurs	-	-	3	0
Delaix	-	-	3	0
† De Launay	-	-	3	4
Duc de Choiseul, rose	-	-	2	0
Duchesse d'Angoulême, nouv.	-	-	3	0
Duchesse de Berrî, carnée	-	-	2	0
Duc de Montebello, carné rose	-	-	2	0
Duputerie	-	-	3	0
Emma, carminée	-	-	2	0
Fanny Bias, rose carné	-	-	2	0
Général Foy	-	-	2	0
Général Thiars, pourp. ve.	-	-	3	0
foncé louté	-	-	3	0
Globe, blanche	-	-	3	0
grande merveilleuse, rose	-	-	2	0
carminé	-	-	2	0
grande monarchie, carnée	-	-	2	0
Guerin, cramoisie violet	-	-	1	50
Hybride de Luxembourg,	-	-	4	0
viol. rouge	-	-	4	0
Joyeuse, pourpre foncé	-	-	3	0
Ladolska marin, pourpre	-	-	3	0
velouté	-	-	3	0
Lady Morgan, rose pourpre	-	-	2	0
Lee, carnée	-	-	3	0
† Marchesay	-	-	3	4
Marie-Louise	-	-	3	0
Marius	-	-	3	0
Masonletti	-	-	3	0
mexicaine, pourpre velouté	-	-	3	0
panaché	-	-	3	0
miroir des Dames, blanc rosé	-	-	3	0
Murinoir (Comte)	-	-	3	0
Ninon de l'Enclos, rose pourpre	-	-	2	0
Nisida	-	-	2	0
Ornement de carafe, rose	-	-	2	0
Orphise	-	-	3	0
petite Sophie, carnée	-	-	2	0
† Poncau capomont	-	-	3	4
pourpre panaché, pourpre	-	-	2	0
violet	-	-	2	0
Prevost (Adèle)	-	-	3	0
Prince Léopold de Saxe-Cobourg	-	-	2	0
Prince de Salme, rose carné	-	-	2	0
Princesses Amélie	-	-	3	0
Prouville carminée	-	-	3	0
Pulcherie de Mielles	-	-	3	0
Regina Isabella, rose pourpre	-	-	3	0
Reine de Bavière, rose violet	-	-	2	0
Reine de Saxe; rose pourpre	-	-	2	0
Renoncule ponctuée	-	-	3	0
rien ne me surpasse, pourpre	-	-	2	0
Roi d'Angleterre, carnée	-	-	3	0
Roi de Rome, de Hollande,	-	-	3	0
r. pourp.	-	-	3	0
Roi des roses, rose	-	-	3	0
Roi de Wurtemberg, cra-	-	-	2	0
moisie claire	-	-	2	0
Salomon, rose	-	-	3	0
Sédentrice (la)	-	-	3	0
Siro, pourpre	-	-	3	0
Triomphe de Brestau	-	-	2	0

Rôsa	La Pièce.	Das Stück.	Fr.	Ct.
provincialis, Virginie, rose carné	-	-	2	0
Vandaëla obscurité, pour-	-	-	3	0
pre velouté	-	-	3	0
volupté	-	-	3	0
rubiginosa, Bérénice, flore pleno, rose	-	-	3	0
carné	-	-	3	0
l'Enfant de Jésus, rose carné	-	-	3	0
Hessoise, pourpre double	-	-	2	0
Poniatowski, carnée	-	-	3	0
Voltaire	-	-	4	0
sempervirens, Adélaïde d'Orléans	-	-	3	0
Duc de Broglie	-	-	3	0
Eugène d'Orléans	-	-	3	0
Fanelli, blanche	-	-	3	0
félicité perpétué	-	-	4	0
pleno Wild, f. p., blanc pur	-	-	2	0
pourpre semi-double	-	-	1	0
Princesses Louise, blanche	-	-	3	0
Princesses Marie, pourpre	-	-	2	0
velouté	-	-	3	0
sulphurea flore pleno, R. à f. jaunes	-	-	2	0
doubl.	-	-	3	0
parva, Roster pompon jaune	-	-	4	0
verdâtre double	-	-	4	0
turbinata lincida plena	-	-	3	0
villosa, Pasché, carnée	-	-	3	0
Léda	-	-	3	0
Une collection de 100 espèces de rosiers	-	-	75	0
basées tiges, assortie avec noms au	-	-	75	0
choix des frères Baumann; Eine Samm-	-	-	75	0
lung von 100 Sorten niederstammigen	-	-	75	0
Rosen mit Namen, nach der Wahl der	-	-	75	0
Gebrüder Baumann, zu	-	-	75	0
Les 25 espèces au choix des amateurs;	-	-	70	0
25 Sorten nach der Wahl der Lieb-	-	-	70	0
haber zu	-	-	70	0
Idem, 100 espèces au choix des amateurs;	-	-	160	0
100 Sorten nach der Wahl der Lieb-	-	-	160	0
haber	-	-	160	0
Idem, la collection de 18 rosiers hautes	-	-	54	0
tiges, en 18 espèces assorties, avec	-	-	54	0
noms; Die Sammlung von 18 hoch-	-	-	54	0
stämmigen Rosen, in 18 Sorten mit	-	-	54	0
Namen, zu	-	-	54	0
Les espèces marquées f. p. seront four-	-	-		
nies à franc pied, et les autres sont	-	-		
écusonnées sur églantiers.	-	-		
Die mit f. p. bezeichneten Sorten, kön-	-	-		
nen sîcht aus der Wurzel, die übrigen	-	-		
sind nur oculirt abgegeben werden.	-	-		
Rubus	-	-		
fruticosus laciniatus, Ronce laciné	-	-	1	0
flore albo pleno	-	-	1	0
flore roseo pleno	-	-	3	0
hispidus	-	-	1	0
inermis De Coud.	-	-	3	0
odoratus L., Framboisier du Canada	-	-	0	50
speciabilis, nov. spec.	-	-	2	50
Salix	-	-		
Agilis	-	-	1	0
argentea	-	-	0	50
† babylonica L., Saule pleureur, Babil.	-	-	0	80
Weide	-	-	5	0
Idem, 25 jeunes plantes; 25 junge Pfl.	-	-	5	0
babylonica annularis, Saule de Ste. Héle	-	-	2	0
bicolor Zwerg., Saule à deux couleurs	-	-	0	50
caroliniana Mich.	-	-	1	0
cinerea foliis variegatis	-	-	0	50
daphnoides, S. cinerea Willd.	-	-	0	50
holosericea	-	-	0	50
Lambertiana Smith	-	-	0	50
laurifolia	-	-	1	0
rosarinifolia	-	-	0	50
tristis Ait.	-	-	1	0
Sambucus	-	-		
angustifolia	-	-	1	0
canadensis De Coud.	-	-	1	50
laciniata var., S. nigra, Sur. noir laciné	-	-	0	50
monstræa	-	-	1	0
nigra foliis variegatis	-	-	0	50
fructu viridi	-	-	0	50
racemosa	-	-	0	50
rotundifolia	-	-	1	0
† Sophora	-	-		
japonica L., Sophora du Japon	-	-	1	50

	La Pièce.	Das Stück.	Fr.	Ct.
<i>Sophora</i>				
pendula	-	-	2	0
fol. variegata	-	-	2	0
† <i>Sorbus</i>				
americana, Sorbier d'Amérique	-	-	1	0
aucuparia L., Sorbier des Oiseleurs	-	-	1	0
domestica, Eschrieche	-	-	3	0
* <i>Spartium</i>				
anceum L., Genista juncea, Gen. d'Espagne	-	-	0	50
Idem, 100 jeunes plantes; 100 Junge Pflanzen	-	-	4	0
incarnatum	-	-	1	0
<i>Spiraea</i>				
acutifolia	-	-	0	50
alpina Pallas	-	-	0	50
aristifolia, nova	-	-	2	0
bella Bot. Mag.	-	-	1	0
betulefolia	-	-	0	50
cana De Cand.	-	-	1	0
crenata L., Spir. à feuilles crénelées	-	-	0	30
Aypericifolia Liss.	-	-	0	50
lavigata W., S. altaica, Spir. à f. lisses, p. t.	-	-	3	0
opulifolia L., Spir. à feuilles d'Obier	-	-	0	50
salicifolia fibre albo, Spir. à feuilles de Saule fibre rose	-	-	0	50
sorbifolia L., Spir. à feuilles de Sorbier	-	-	0	50
tomentosa, Spirée cotonneuse, p. t.	-	-	0	50
triloba, Spirée à trois lobes	-	-	0	50
ulmifolia Scopoli	-	-	1	0
<i>Staphylea</i>				
pinnata L., Staphillier à feuilles pennées	-	-	0	50
trifoliata L., St. à trois feuilles	-	-	1	0
<i>Stuartia</i>				
Malachodendron, St. monostyle, p. t.	-	-	4	0
* <i>Stillingia</i>				
sebifera Willd.	-	-	2	0
<i>Symphoria</i>				
mexicana De Cand.	-	-	2	0
<i>Syringa</i>				
chinesis Willd., Lilas varin	-	-	0	80
Josike's nov. spec.	-	-	3	0
persica, Lilas de Perse	-	-	1	0
fibre albo	-	-	1	0
laciniata, Lilas à feuilles découpées	-	-	0	50
sauzer	-	-	3	0
vulgaris L., Lilas commun	-	-	0	30
grandiflora	-	-	2	0
f. albo, Lilas com. à fleurs blanches	-	-	0	90
fibre rubro, L. de Marly	-	-	0	80
<i>Tamarix</i>				
gallica L., Tamarisc de France	-	-	0	80
germanica L., Tamarisc d'Allemagne	-	-	0	50
<i>Taxus</i>				
baccata L., If commun, p. t.	-	-	1	50
Idem, 12 replants de 3 ans; 12 St. 3-jähr.	-	-	3	0
Setling	-	-	5	0
foliis aereo variegatis, p. t.	-	-	5	0
nucifera, p. t.	-	-	3	0
pyramidalis, p. t.	-	-	5	0
<i>Thuja</i>				
occidentalis L., Arbre de vie d'occid. p. t.	-	-	1	0
orientalis L., Arbre de vie d'orient, p. t.	-	-	1	0
pyramidalis, p. t.	-	-	3	0

	La Pièce.	Das Stück.	Fr.	Ct.
<i>Tilia</i>				
tatarica, p. t.	-	-	2	0
alba Hort. Kew	-	-	1	50
americana L., Tilleul d'Amérique	-	-	1	50
nigra	-	-	1	50
argentea nova	-	-	2	0
asplenifolia nova, à d'Asplenium	-	-	2	0
europaea L., Tilleul d'Europe	-	-	1	50
aerea, T. doré	-	-	2	0
macrophylla	-	-	1	50
mississippiensis	-	-	1	50
viridis, nov. sp.	-	-	3	0
<i>Ulex</i>				
europaea	-	-	0	50
hibernica, nov. spec.	-	-	2	0
nana fibre pieno	-	-	1	0
<i>Ulmus</i>				
fulva	-	-	1	50
flatifolia	-	-	1	50
oxoniensis	-	-	2	50
pedunculata W., effusa	-	-	1	0
pyramidalis, U. fastigiata	-	-	1	0
rugosa	-	-	2	0
artificialis	-	-	1	0
<i>Vaccinium</i>				
frondosum Willd.	-	-	3	0
macrocarpum Willd.	-	-	2	0
Oxycoccus, Schöllera Oxycoc. Per., p. t.	-	-	1	0
Oxycoccus foliis variegatis	-	-	2	50
pennsylvanicum Lam., p. t.	-	-	2	0
<i>Viburnum</i>				
dentatum Liss.	-	-	2	0
edule Pers.	-	-	1	50
Lentago L., V. luisante	-	-	1	0
Opulus rosea, V. Sterile, Pelote de Neige	-	-	0	50
Oxycoccus Pers.	-	-	1	50
prunifolium L., V. à feuil. de prunier	-	-	1	50
rugosum	-	-	2	0
Tinus	-	-	1	30
foliis variegatis	-	-	2	0
* <i>Vitex</i>				
Agnus castus L., Gattillier commun	-	-	1	50
incisa Willd.	-	-	1	50
<i>Vitis</i>				
cordata	-	-	1	0
Labrusca L., Vigne cotonneuse	-	-	1	0
odoratissima	-	-	1	0
vulpina L., V. de renard	-	-	0	50
<i>Xanthoxylum</i>				
Clava-Hercule L., Zanth. à gr. aiguil.	-	-	1	50
Plus, au choix des Frères Baumann, une collection d'arbustes et arbres d'ornement de pleine terre, en 100 différentes espèces assorties avec noms, à raison de	-	-	50	0
Mehr, nach der Wahl der Gebrüder Baumann, eine Sammlung von 100 verschiedenen Sorten Zierbäume und Ziersträucher, mit Namen, zu	-	-	50	0
Plus, à leur choix, 1000 beaux sujets d'un bel assortiment arbustes d'ornement, en trente espèces différentes, avec noms	-	-	150	0
Mehr, nach ihrer Wahl, 1000 St. sehr schöne Verzierungs Sträucher, in 30 verschiedenen Sorten mit Namen	-	-	150	0

ARBUSTES DE CLÔTURE ET DE PALISSADE.—HEDGE PLANTS.

N.B. Les objets marqués d'une * sont propres aux palissades de séparation et d'ornement, et les autres aux clôtures de défense.

EINZÄUNUNGS-STRÄUCHER.

N.B. Diejenigen mit * bezeichneten Gegenstände dienen zu Zier-oder zu Scheidungsbügel, die übrigen aber zu Vertheidigungszäune.

	Le 100.	Das 100.	Fr.	Ct.		Le 100.	Das 100.	Fr.	Ct.
<i>Carpinus</i>					* <i>Corychorus</i>				
Betulus, Charmille	-	-	2	0	* japonicus fibre pieno	-	-	4	0
* <i>Colutea</i>					* <i>Cornus</i>				
*arboræcens, Baguenaudier	-	-	5	0	*mascula, Cornouiller mâle	-	-	12	0

	Le 100.	Das 100.	Fr.	Ct.		Le 100.	Das 100.	Fr.	Ct.
<i>Crataegus</i>					<i>Robinia</i>				
<i>Oxyacantha</i> , Epine blanche	-	-	2	0	Idem, le 1000 plantes d'un an; das 1000	-	-	15	0
<i>Cytisus</i>					jährlige Pflanzen	-	-	-	-
<i>Laburnum</i>	-	-	5	0	<i>Rosiers</i>				
<i>Euonymus</i>					mélangés, espèces doubles	-	-	18	0
europæus, Fusain, bonnet de prêtre	-	-	3	0	<i>Sambucus</i>				
<i>Fagus</i>					racemosa	-	-	10	0
<i>syriaca</i> , Hêtre	-	-	5	0	<i>Spartium</i>				
<i>Genista</i>					<i>junceum</i>	-	-	5	0
<i>germanica</i> , Gênet d'Allemagne	-	-	3	0	<i>Spiræa</i>				
<i>Hippophae</i>					<i>chamadriifolia</i> , Spirée à feuilles de	-	-	5	0
rhamnoides, Rhamnoïde	-	-	5	0	<i>Chamadrya</i>	-	-	5	0
<i>Jasminum</i>					<i>salicifolia</i> , Sp. à feuilles de Saule	-	-	5	0
<i>fruticans</i> , Jasmin cytiæ	-	-	5	0	<i>Syringa</i>				
<i>Ligustrum</i>					<i>chinensis</i>	-	-	15	0
<i>vulgare</i> , Fraissillon	-	-	4	0	<i>persica</i>	-	-	15	0
<i>Morus</i>					<i>vulgaris</i> , Lilas commun	-	-	6	0
<i>alba</i> , Mûrier blanc	-	-	5	0	<i>Tamarix</i>				
<i>Pinus</i>					<i>germanica</i>	-	-	6	0
<i>abies</i> , Épicéa	-	-	15	0	<i>Thuja</i>				
<i>Ribes</i>					<i>occidentalis</i> , Thuja du Canada	-	-	12 à 25	0
<i>Grossularia</i> , Grosseiller épineux	-	-	6	0	<i>orientalis</i> , Thuja de la Chine	-	-	15 à 30	0
<i>Robinia</i>					<i>Ulex</i>				
<i>Pseud-acacia</i> , Robinier	-	-	2 à 5	0	<i>europæa</i> , Ajonc	-	-	10	0

V.

List of Trees and Shrubs, with the Prices for 1838, taken from the Retail Catalogue of JAMES BOOTH and SONS, Proprietors of the Flottbeck Nurseries, Hamburg.

	s.	d.		s.	d.		s.	d.
<i>Acer</i>			<i>Æsculus</i>			<i>Amygdalus</i>		
<i>austriacum</i>	-	1 0	<i>Hippocastanum</i> L.	0	3	<i>argentea</i> (orientalis)	2	6
<i>barbatum</i>	-	1 6	fol. arg. var.	1	0	<i>Bassorina</i>	-	2 6
<i>campêtre</i>	-	0 2	aur. var.	3	9	<i>campêtris</i>	-	2 6
fol. varieg.	2	6	<i>crispum</i>	3	6	<i>communis</i>	-	0 4
<i>crêticum</i>	-	1 6	<i>incisum</i>			<i>dalis</i> (frâgile)	0	9
<i>dasycarpum</i>	-	1 0	<i>Booth</i>	3	6	<i>fl. albo</i>	5	0
<i>hybridum</i>	-	1 0	<i>nigrum</i>	1	6	fol. aur. var.	5	0
<i>ibericum</i>	-	4 0	<i>pre'cox</i>	1	3	<i>macrocarpa</i>	-	1 0
<i>laciniatum</i>	-	0 6	<i>striatum</i>	1	6	<i>nana</i> L.	-	0 3
<i>Lobelia Tenore</i>	5	0	<i>tortuosum</i>			<i>georgica</i>	-	3 0
<i>lobata Fisch.</i>	1	6	<i>Booth</i>	2	0	<i>Peraica</i>	-	0 6
<i>macrophyllum</i>	5	0	<i>hybrida</i>	-	1 0	<i>Nectarina</i>	0	6
<i>monspesulanum</i>	0	3	<i>lutea</i> (flava)	-	0 6	<i>fl. pl.</i>	0	9
<i>montanum</i>	-	0 6	<i>Lyoni</i>	-	2 6	<i>pumila</i> fl. pl.	-	0 9
<i>Nepesado</i> L.	-	0 3	<i>macrostachya</i> (spi-			<i>sibirica</i> Gaesl.	1	6
<i>crispum</i>	0	6	<i>cata</i>	-	0 9	<i>tomentosa</i>	-	2 6
<i>nepalense</i> (oblongum)	-	2 6	<i>ohioensis</i>	-	0 6	<i>Andromeda</i>		
<i>nigrum</i>	-	1 0	<i>Pavia</i> Mx.	-	0 6	<i>acuminata</i> L.	-	2 0
<i>obtusatum</i>	-	0 9	fol. varieg.	5	0	<i>arbores</i> L.	-	2 6
<i>Opalus Willd.</i>	1	0	<i>pallida</i>	-	2 0	<i>axillaris</i>	-	2 6
<i>opulifolium</i>	-	3 6	<i>pumila</i> (rubicanda)	0	9	<i>calyculata</i> L.		
<i>palmatum</i>	-	2 6	<i>Ailantus</i>			<i>nana</i>		
<i>Pavia</i> (curious)	3	0	<i>glandulosa</i> Ait.	0	3	<i>caspiifolia</i>		
<i>platanoïdes</i>	-	0 3	<i>Ailnus</i>			<i>Frœt.</i>		
<i>Pseudo-Platanus</i> fol. varieg.	0	6	<i>americana</i>	-	0 4	<i>Catechu</i>		
<i>longi folium</i> (new)	3	0	<i>canadensis</i>	-	0 6	<i>dealbata</i>	-	2 6
<i>lutescens</i>	0	9	<i>cordifolia</i> Desf.	0	9	<i>flava</i>	-	2 6
<i>recurvatum</i>	-	0 3	<i>glutinosa</i>	-	0 3			
<i>röbrum</i>	-	0 3	<i>laciniata</i>	-	0 4			
<i>saccharinum</i>	-	0 6	<i>oxycanthifolia</i>	1	6			
<i>spicatum</i>	-	0 4	<i>röbra</i>	-	0 6			
<i>striatum</i> (pennsylvanicum)	-	0 9	<i>incana</i>	-	0 3			
<i>tataricum</i> L.	-	0 6	<i>macrophylla</i>	-	2 6			
<i>Æsculus</i>			<i>oblongata</i>	-	2 6			
<i>coriacea</i>	-	4 0	<i>plicata</i> , plaited leav.	2	6			
<i>discolor</i>	-	2 6	<i>serrulata</i>	-	0 4			
<i>glabra</i>	-	2 6	<i>undulata</i>	-	2 6			
			<i>viridis</i>	-	3 6			
			<i>Amygdaline</i>					
			<i>oxifolia</i>	-	1 0			

	s.	d.
Andrómeda		
maritima	2	6
nitida (coriacea)		
paniculata L. (vide Lyónis)	1	0
pollifolia		
hùmilis	} 0	9 each
latifolia		
màjor		
minor		
oleifolia		
ovata		
rösea		
revoluta		
pulverulenta	2	6
racemosa L.	1	6
salicifolia (nov. sp.)	5	0
speciosa	2	6
vaccinioides	2	0
Aralia		
spinosa L.		
Arctostáphylos		
alpina (A'rbutus)		
Aristolöchia		
alpa L'Herit.		
tomentosa		
Artemisia		
Abrotanum		
sibirica		
Astrágalus		
Tragacantha		
Atriplex		
Äälimus		
Berberis		
aristata (nepalensis)	1	6
asiatica (Roosburgh)	2	0
buxifolia Län.	3	6
canadensis	0	3
var.	0	6
caroliniana	2	0
chinensis	2	6
crataegina	3	6
cratica	1	0
dättrica	5	0
dúlcis	2	6
emarginata Willd.	2	6
heterophylla	7	6
silicifolia (glauca)		
sibirica	3	6
vulgaris	0	3
asperma	0	6
dúlcis	7	6
fr. álbo	0	3
violáceo	0	9
subrotándo	1	0
Berohèmia		
vulvabilis	3	6
Bétula		
álba	0	3
laciniata (asplenifolia)	4	6
péndula	0	3
antàrtica	3	6
bélla (from China, 1832, half-hardy, the most graceful shrub of the genus)	10	6
carpathica	3	6
carpinifolia	0	3
dättrica	3	6
excoëta	0	6
fruticosa	0	3
glandulosa	0	6
lènta	0	6
lütta	0	6
macrocarpa		
nana	0	3
parvifolia	1	0
màjor	1	0
nigra	1	0
ovata	2	6
papyracea	0	3
populifolia	0	6

	s.	d.
Bétula		
pùmila	0	6
Socobifia	3	6
tomentosa	2	6
undulata	0	9
urticifolia	0	6
Bignónia		
Catápa (Castápa syriacaefolia)	0	3
radicans	0	6
sàva	3	6
màjor	2	0
Börya		
Agústrina	0	9
Broussonétia		
papyrifera	0	3
cucullata	5	0
Bupleürum		
fruticolum	0	6
Búxus		
sempervirens	} 0	4 each
angustifolia		
arborescens		
fol. argent. var.		
fol. aur. var. minor		
myrtifolia		
suffruticosa		
Calycánthus		
floridus	0	4
pensylvanicus	0	6
splenifolius	7	6
inodorus	4	6
longifolius	2	6
variegatus	5	0
fertilis	1	6
fèrox ?	1	6
glauca (acuminat)	1	6
lavigatus (nanus)	2	0
heterophyllus	5	0
pra'cox (Chimon. frag.)	1	6
Caragána		
Aitagdina	1	0
arborescens	0	3
arenaria	1	0
Chamidgu	0	3
frutescens	0	9
glomerata	2	6
grandiflora (vera)	3	6
jubata (plants from seed or on their own bottoms)	15	0
molliis var. glabra	2	0
pygmaea	0	3
Reidowskii	2	0
sèplum		
spinosa	0	3
albida	10	6
Cárpinus		
americana	0	6
fol. var.	5	0
Bétulus	0	3
fol. aur. var.	5	0
incisa	0	9
Carpinosa	3	6
orientalis	0	6
vulgaris (Ostrya heterophylla (Pseudo-Quercus))	21	0
Carya		
álba	} 0	6 each
amara		
olivastiformis		
porcina		
tomentosa		
Castanea		
vésca	0	3
asplenifolia	0	9
cochleata	3	6
glaberrima	0	9

	s.	d.
Castanea		
vésca fol. maculat.		
luteo	2	6
fol. varieg	1	6
pùmila (americana)	0	9
Ceanòthus		
americanus L.	0	3
decumbens	2	6
ovatus	2	6
microphyllus	1	6
Celástrus		
scandens L.	0	4
Céltis		
australis L.	0	3
cordata	1	0
crassifolia Lam.	1	0
occidentalis L.	1	0
pùmila	5	0
Tournefortii	3	6
Cephalánthus		
occidentalis L.	0	3
Cércis		
canadensis L.	1	0
Siliquastrum L.	0	9
fl. álbo	3	6
Chionánthus		
maritima Pursh	4	0
virginica L.	1	0
montana	4	0
Clématis		
alpina (Atrágene)	0	6
carnea	3	6
angustifolia Dec.	1	0
brevicaudata		
campaniflora	0	9
crispa	1	0
dahurica	2	6
Flammula	0	4
pallida	1	6
maritima L.	1	6
fruticosa		
florida		
fl. pl.	1	9
glauca	0	6
lasiantha		
hybrida	0	9
revoluta	0	9
sibirica (Atrágene) Spreng.	0	9
Viorna		
hybrida	2	6
viornoides	2	6
Vitalba	0	3
Viticella	0	3
fl. pl.	1	6
màjor	1	0
pallida	1	0
rùbra	0	3
màjor	1	0
rubella	1	0
virginiana	1	0
Cléthra		
acuminata	} 0	6- 1 0
alnifolia L.		
paniculata		
pubescens (tomentosa)		
Colútea		
arborescens L.	0	3
crispa	0	3
mèdia	1	0
nepalensis	5	0
orientalis (cruenta) Län.	0	7
Pocockii	0	9
Comptónia		
asplenifolia L'Her.	0	9
Córchorus		
japónicus (Kérris jap.)	0	3
fl. simplicifolia	7	6

	s.	d.
Coriaria		
myrtifolia	0	3
Córnus		
álba L.	0	3
fol. varieg.	0	6
asperifolia	1	0
alternifolia L.	0	6
candidissima	0	6
fol. varieg.	0	6
circinnata (verru-		
còsa)	0	6
fastigiata	0	6
florida L.	0	3
máscula L.	0	3
flava	0	9
fol. varieg.	2	6
paniculata L'Herit.	0	3
sanguinea	0	2
fol. varieg.	0	6
sericea	0	3
sibirica	0	3
stricta L'Herit.	1	0
Coronilla		
E'merus Willd.	0	3
Córylus		
americana	0	3
arborescens	3	6
Aveliana	0	2
álba	0	4
rúbra	0	4
fol. atropurpú-		
reis (Coryl.		
atropurp.)	2	6
barcelonenis	0	9
glomerata	0	9
grándis	0	9
laciniata	4	0
Cólurna L.	0	6
heterophylla	7	6
rostrata	0	6
tubulosa Willd.	0	6
Cotoneáster		
acuminata Lind.	1	0
affinis Lind.	0	9
frigida	2	6
intermedia		
laxiflora Jac.	3	0
melanocarpa	1	6
microphylla Lind.	0	3
var. U'va-ursi	0	6
nummularia	2	6
rotundifolia	2	6
racemiflora Spreng.		
tomentosa Lind.	1	6
uniflora Bunge	10	6
vulgaris Lind.	0	3
Crataegus (Mespilus)		
apifolia	1	0
arbutifolia	0	6
Asarctica L.	0	6
betulifolia	1	0
Celsiana Bosc	1	0
coccinea Ward	0	6
cordata	0	6
Crus-galli Willd.	0	6
splendens	1	0
cuneifolia	1	0
elliptica Ait.	0	6
flava	0	6
germanica (Mespil-		
lus)	0	6
fruct. sine		
nucleo	0	6
macrophylla	2	6
glandulosa Marnck	0	6
grandiflora	0	9
grossularifolia	1	0
heterophylla	2	6
hybrida	0	6
lanulosa	1	0
lobata	1	0
lucida	0	6
monogyna	0	6
fol. varieg.	0	6

	s.	d.
Crataegus		
nigra	0	9
odorata	0	6
Oliverrona ?	1	0
orientalis Spreng.	1	0
Oxyacantha	0	2
flor. rubro	0	6
rú. pl.	3	6
pleno	0	6
lutescens	1	6
pendula	1	6
praecox	1	0
quercifolia	2	0
spin. long.	0	6
stricta	1	6
parvifolia	1	0
pectinata	1	0
pentagyna	1	0
praecox	1	0
pterifolia	7	6
pubescens	0	9
pyracanthifolia	0	6
sanguinea (Siberian		
Thorn)	2	0
tanacetifolia Petr.	0	6
tomentosa	0	6
virginiana	0	6
xanthocarpa	0	6
Cupressus		
disticha (Schubertii)		
L.	0	3
pendula (sinensis)	2	6
juniperoides	0	9
lusitana	2	6
sempervirens	0	3
horizontalis	0	3
pendula	4	8
snyderi	0	6
fol. varieg.	3	6
Cydonia (Pyr. Cyd.)		
chinensis	0	9
japonica (Pyrus jap.)	0	6
fl. albo	0	6
fl. luteo (se-		
mipleno)	2	6
vulgaris	0	2
lusitana	0	6
pyrifomis	0	2
Cyrilla		
racemiflora	7	6
Cytisus		
alpinus	0	3
fragrans	1	0
argenteus	2	0
austriacus	0	3
biflorus	0	6
caucasicus	3	0
calycinus	1	6
capitatus	0	3
chinensis	1	0
elongatus Willd.	0	9
falcatius	0	3
hirtus L.	0	3
Laburnum L.	0	3
fol. var.	0	6
involutum (new)		
leaves like S.		
annularis	3	6
pendulum	1	0
purpurascens (fl.		
roseo) Adami	0	9
quercifolium	0	6
leucanthus	0	9
nigricans	0	8
pallidus		
polytrichus	2	6
pauciflorus	3	6
prostratus	1	0
purpureus Willd.	0	3
albiflorus	2	6
erectus	1	6
suptus	7	6
roseo (new)	1	0
sensitifolius	1	0

	s.	d.
Cytisus		
triflorus	1	0
uralensis	1	0
Weldnii	0	3
racemosus	3	6
Daphne		
alpina	2	6
albica	2	6
Cneorum	1	0
fol. varieg.	1	6
Lauricola Willd.	0	6
Messeriens L.	0	6
flor. albo	0	9
autumnale	1	6
pontica	0	4
Diervilla		
canadensis	0	3
Diospyros		
Lotus L.	1	0
virginiana L.	0	6
Dirca		
palustris	3	0
Elaeagnus		
angustifolia L.	0	3
conferta	3	6
fusca		
hortensis	2	6
latifolia	0	9
macrophylla	0	6
E'mpetrum		
álbum	3	6
rúbrum, from		
Staaten Island	2	6
nigrum	0	3
rúbrum	1	6
scoticum	1	6
E'phedra		
chilensis	1	6
distachya	1	6
minor	1	6
Epigaea		
repens	3	6
Erica		
ciliaris		
cinerea flava		
atropurpurea		
rúbra		
herbacea		
multiflora		
álba		
canadensis		
vulgaris		
álba		
fl. pl.		
fol. var.		
Euonymus		
americanus	0	9
angustifolius (nanus)	0	6
atropurpureus	1	0
chinensis	5	0
europaeus	0	2
fr. albo	0	6
coccineo	1	6
fol. varieg.	1	6
Hamiltonianus	2	6
nanus	0	6
japonicus	2	6
fol. arg.	3	6
fol. aur.	3	6
latifolius	0	9
obovatus	0	9
pallidus	0	9
verrucosus Scop.	0	9
Fagus		
ferruginea Ait.	2	6
sylvatica	0	2
splenisfol.	1	6
crispa	3	6
fol. varieg.	2	6

0 3 0 9
each

	s.	d.
Fagus		
<i>syriaca pendula</i>	2	6
<i>purpurea</i>	1	0
<i>quercifolia</i>	2	0
Fontanèsia		
<i>phillyroides Willd.</i>	0	3
Fothergilla		
<i>cinifolia</i>	0	6
<i>tomentosa (pubescens)</i>	1	6
Fraxinus		
<i>acuminata</i>	0	9
<i>alba</i>	0	9
<i>americana</i>	0	6
<i>argentea</i>	0	9
<i>diacolor</i>	2	6
<i>elliptica</i>	1	0
<i>epiptera</i>	0	9
<i>excelsior</i>		
<i>aurca</i>	0	6
<i>fol. varieg.</i>	0	6
<i>pendula</i>	1	0
<i>salicifolia</i>	2	0
<i>striata (jaspidea)</i>	0	9
<i>expansa</i>	0	9
<i>glauca</i>	0	9
<i>heterophylla Vahl</i>		
<i>(simplicifol.)</i>	0	6
<i>juglandifolia Lamb.</i>	0	6
<i>lancea Bosc</i>	1	6
<i>lenticifolia</i>	0	9
<i>pendula</i>	8	6
<i>lyrata</i>	1	6
<i>microphylla</i>	1	6
<i>nana Willd.</i>	0	4
<i>crispa</i>	0	6
<i>nigra</i>	0	9
<i>Oryz.</i>	0	6
<i>variet.</i>	1	0
<i>oxycarpa</i>	2	0
<i>oxyphylla</i>	0	6
<i>parvifolia</i>	0	9
<i>peninsularica</i>	0	9
<i>platycarpa</i>	1	0
<i>pubescens Willd.</i>	0	9
<i>quadrangulata Mx.</i>	3	9
<i>nervosa</i>		
<i>Richardi Bosc</i>	1	0
<i>rotundifolia</i>	0	6
<i>sambucifolia Willd.</i>	0	3
<i>viridis</i>	1	0
<i>verrucosa</i>	1	0
Gaultheria		
<i>procumbens</i>	0	6
<i>acuminata</i>	3	6
<i>Shallon Pursh</i>	0	6
Genista		
<i>anglica L.</i>	0	3
<i>anzantica</i>	3	0
<i>florida</i>	0	3
<i>leucantha</i>	3	6
<i>germanica</i>	0	3
<i>lusitânica L.</i>	0	6
<i>ovata Waldst.</i>	2	6
<i>pilosa</i>	1	6
<i>prostrata</i>	0	9
<i>sagittalis</i>	0	6
<i>scoparia (Spárt.)</i>	0	3
<i>fol. varieg. (Spárt.)</i>	2	6
<i>fl. albedo (Spárt.)</i>	2	6
<i>fl. pl.</i>	2	6
<i>sibirica</i>	0	3
<i>tinctoria</i>	0	3
<i>fl. pl.</i>	1	0
<i>triquetra</i>	0	9
Gleditschia		
<i>cáspica (Prosopis)</i>	3	6
<i>hórrida (véra)</i>	1	0
<i>inermis</i>	0	9
<i>latifolia</i>	0	9
<i>longispina</i>	0	9
<i>macracantha (férox)</i>	0	9
<i>monosperma Wall.</i>	0	6
<i>orientalis</i>	2	6

	s.	d.
Gleditschia		
<i>triscanthes L.</i>	0	3
<i>sinensis</i>	1	0
<i>longispina</i>	1	6
Glycine		
<i>chinensis Bot. Mag.</i>	1	6
<i>frutescens L.</i>	1	0
Gordonia		
<i>pubescens</i>	2	6
<i>lasianthus</i>	2	6
Gymnocladus		
<i>canadensis</i>	0	9
Halésia		
<i>díptera</i>	6	0
<i>macrocarpa</i>	2	6
<i>tétraptera L.</i>	1	0
Halimodéndron		
<i>argenteum (vid. Robinia)</i>	1	6
Hamamelis		
<i>virginica</i>	0	6
Hédéra		
<i>Helix</i>		
<i>digitata</i>	0	9
<i>fol. varieg.</i>	0	6
<i>fr. luteo</i>	1	3
<i>elegans</i>	1	6
<i>hibérnica (latifolia)</i>	0	3
<i>arbores</i>	1	0
<i>fol. aur. var.</i>	1	6
Helianthemum		
<i>diversifolium fl. pl.</i>		
<i>hyssopifolium</i>		
<i>hyssopifolium creb- ceum</i>		
<i>mys. fl. pl.</i>		
<i>mutabile</i>		
<i>pállidum</i>		
<i>rúbrum</i>		
<i>nummularium</i>		
<i>venustum</i>		
<i>vulg. álbum fl. pl.</i>	0	6 each
<i>flavescens fl. pl.</i>		
<i>fliscum fl. pl.</i>		
<i>luteum fl. pl.</i>		
<i>roseaceum fl. pl.</i>		
<i>roseum fl. pl.</i>		
<i>simpl.</i>		
<i>sulphureum</i>		
<i>pállid. fl. pl.</i>		
Hibiscus		
<i>syriacus L.</i>	0	3
<i>11 varieties</i>	1	3 each
Hippóphae		
<i>canadensis L.</i>		
<i>(Shepherdia)</i>	0	4
<i>rhomboides L.</i>	0	4
<i>salicifolia (Nepal)</i>	0	6
Hydránga		
<i>arborescens L.</i>	0	3
<i>levigata</i>	1	0
<i>nivea (glauca)</i>	0	4
<i>quercifolia</i>	1	6
<i>radiata</i>	2	0
Hypéricum		
<i>Androsæmum</i>		
<i>calycinum</i>		
<i>hircinum L.</i>	0	6 each
<i>Kalmianum</i>		
<i>prolificum L.</i>		
<i>uralense</i>		
Jasminum		
<i>fraticans L.</i>	0	3
<i>máior</i>	0	9
<i>Wallichianum</i>	0	9
<i>officinale</i>	0	4
<i>fol. aur. varieg.</i>	2	0
<i>fol. argent. var.</i>	2	0
Ibèris		
<i>sempervirens</i>	0	3

	s.	d.
Ilex		
<i>Aquifolium L.</i>		
<i>alb. maculat.</i>		
<i>marginat.</i>		
<i>aur. maculat.</i>		
<i>marginat.</i>		
<i>aur. var.</i>		
<i>férox</i>		
<i>fol. arg. var.</i>	1	0—1 6
<i>fol. aur. var.</i>		each
<i>fol. argent. var.</i>		
<i>fr. luteo</i>		
<i>latifolium</i>		
<i>baleárica Desf.</i>		
<i>ciliata</i>		
<i>crassifolia</i>		
<i>opaca</i>		
<i>prinoides</i>		
<i>scotica</i>		
Itea		
<i>virginica</i>	0	6
Juglans		
<i>cinerea</i>	1	0
<i>fraxinifolia</i>	1	0
<i>myristicæformis</i>	3	6
<i>nigra</i>	0	6
<i>fr. oblongo</i>	0	6
<i>regia</i>	0	6
<i>asplenifolia</i>	10	6
<i>villosa</i>	1	0
<i>(vide Carys)</i>		
Juniperus		
<i>bermudiána</i>	0	6
<i>chinensis</i>	2	6
<i>communis</i>	0	3
<i>dábrica</i>	3	6
<i>excelsa</i>	10	6
<i>interrupta</i>	3	6
<i>lycia</i>	1	0
<i>Oxycedrus L.</i>	3	0
<i>phoenicea L.</i>	3	0
<i>prostrata Mx.</i>	2	0
<i>recurva (pendula)</i>	1	0
<i>Sabina</i>	0	3
<i>fol. varieg.</i>	1	0
<i>tamariscifolia</i>	0	9
<i>sibirica (véra)</i>	0	9
<i>suecica</i>	0	6
<i>hispanica</i>	1	6
<i>virgiliána</i>	0	3
<i>caroliniana</i>	0	6
Pa		
<i>frutescens</i>	2	6
Kálmia		
<i>angustifolia L.</i>		
<i>fol. var.</i>		
<i>glauca</i>	1	0—2 0
<i>latifolia</i>		
<i>oleaeifolia nitida</i>		
<i>panicula</i>		
<i>rúbra</i>		
Koelreutéria		
<i>paniculata L'Herit.</i>	0	6
Laúrus		
<i>caroliniana Pursh</i>	0	6
<i>Benzoin L.</i>	0	6
<i>Sassafras L. (Pé- sea Sassafras).</i>	1	0
Lèdum		
<i>angustifolium (ros- marinif.)</i>		
<i>buxifolium (Am- myrsine)</i>		
<i>latifolium</i>	1	0—2 0
<i>palústre</i>		
<i>decumbens</i>		
<i>thymifolium (Am- myrsine)</i>		
Ligústrum		
<i>vulgare</i>	0	2
<i>fol. varieg.</i>	0	6
<i>fr. luteo</i>	0	3

	s. d.
Ligustrum	
vulgare italicum	0 3
foliosum	0 9
Linnaea	
borealis	1 0
americana	2 6
Liquidambar	
Styraciflua L.	0 3
imbérbe	7 6
Liriodendron	
Tulipifera	0 6
integrifolia	3 9
obtusiloba	3 9
Lonicera (A.)	
alpigena	0 4
altáica	-
ciliata <i>Pursh</i>	0 6
caerulea	0 4
praecox	1 0
Diervilla (Diervilla)	
lutea	0 3
hispidá	2 6
ibérica	1 6
nigra L.	0 3
orientális	1 0
sibirica	0 4
Solonia (Xyloteum)	
Solonia	0 6
tatarica	0 3
alba	0 3
baccis albis	1 0
rúbra	0 6
villósa <i>Pursh</i>	0 6
Xyloteum	0 3
nigrum	1 0
Caprifolium (B.)	
italicum	0 3
fl. albo	0 3
fl. rubro	0 3
fol. var.	0 6
balcaricum	1 6
etruscum	1 6
diocum	0 6
flexuosum	0 6
Fraserii	1 6
Goidii	1 6
gratum	1 0
hispidulum	1 0
Ledebourii	5 0
longifolium	2 0
parvifolium	3 0
Periclymenum	0 3
fol. var.	0 6
quercifolium	0 3
proliferum (from America)	0 6
sempervirens	0 4
coccineum	1 0
sempivernum	2 6
Lycium	
barbarum	0 3
carolinianum	0 3
chinense	0 9
europaeum L.	0 3
lancoletum	0 9
ovatum	0 9
ruthenicum	0 6
Trewinense	0 6
rigidum	4 0
Lyonia	
paniculata (Andromeda)	0 6
Maclura	
aurantiaca	2 0
Magnolia	
acuminata L.	1 6
maxima	6 0
conspicua	5 0
cordata	3 6
glauca	1 0
macrophylla	8 0
obovata (purpurea)	-
5 varieties,	2 6 each

	s. d.
Magnolia	
Soulangiana	6 0
Thomsoniana	6 0
umbrella (tripetala)	2 0
Menispermum	
canadense L.	0 2
Menziesia	
globularis	2 6
polifolia (Erica Dah.)	0 3
fl. albo	0 9
minor	0 6
purpurea	0 6
Mespilus	
(Vide Pyrus et Crataegus)	
arbutifolia (v. Pyrus)	0 6
fr. nigro	0 6
canadense (v. Pyrus Botr.)	0 6
Chamaemepilus L. (v. Pyrus)	0 9
floribunda	2 6
germanica diffusa	0 6
fr. sine nucleo	0 9
macrophylla	2 6
Pyraeantha	0 3
nitida	3 6
Mitchella	
repens Willd.	2 6
Morus	
alba L.	0 3
Morettiana	0 9
nervosa	10 6
tatarica	1 0
canadensis	1 6
giabra	1 6
constantinopolitana	2 6
multicaulis (alba bullata)	1 6
nigra	0 6
papyrifera (vid. Broussonetia papyrifera)	-
pennsylvanica	1 6
rúbra L.	1 0
Myrica	
carolinensis	0 6
cerifera L.	0 3
quercifolia	0 9
Gale	0 3
form.	0 3
pennsylvanica	1 6
Nyssa	
biflora (aquatica Pursh)	-
candicans	1 0
denticulata	2 0
villósa	-
Ostrya	
virginica	0 6
vulgaris	0 6
Paeonia	
arbores	2 6
papaveracea	5 0
rubra	10 6
Paliurus (Zisypus)	
australis	0 9
Periploca	
græca L.	0 3
Pérsea	
Sesquifera, vide	-
Laurus	1 0
Philadelphus	
coronarius L.	6 3
fl. pl.	0 4
fol. varieg.	0 4
gracilis Dec. (hirtus)	0 4
grandiflorus (latifolius)	0 9
inodorus L.	0 4

	s. d.
Philadelphus	
lævis	1 6
nanus	0 3
Zeyheri Schrader	1 6
Phillyrea	
7 spec. et var.	0 9- 1 6
Pinus (A.)	
altissima (Laricio)	0 4
australis	0 4
Banksiana Willd.	7 6
hardy, 19°	-
Cembra L.	0 6
heivética	1 6
caranunica, 5° or 6°	15 0
Fischeri Booth (Caled. Hort. T.)	-
hardy	10 6
halepensis Willd.	-
tender G. H.	0 6
lnoas, hardy	0 6
insignis	75 0
Lambertiana	300 0
hardy 8° or 10°	-
lutea	5 0
maritima Willd.	-
hardy	0 6
mitis Mx., hardy	0 6
nigræscens, hardy,	-
Nepal	5 0
palustris, tender	3 0
excelsa Booth (Cal. Hort. T.) quite	-
hardy	63 0
Pinæa tender,	0 3
not stand 4°	-
ponderosa, quite	-
hardy, 6 ft.	10 6
pumilio (Mégale)	-
Willd.	0 3
resinosa, half hardy	1 6
rigida, hardy	1 0
Sabiniana, out	-
two winters 6°	15 0
variet. not	-
tried	15 0
serotina, quite	-
hardy	1 6
Strobus, hardy	0 3
compressa Booth,	-
hardy	7 6
sylvestris	0 3
Taeda, hardy	0 6
tatarica, hardy	10 6
uncinata	10 6
variabilis, hardy	0 6
Abies (B.)	
alba	0 3
brütia, rather tender	21 0
balsamifera	0 3
longifolia	1 0
canadensis	0 3
Cianbraasiliana	2 0
caribæa Reichb., quite hardy	10 6
Douglasii, as hardy as the common oak, 11 ft. in 5 or 6 years	10 0- 30 0
excelsa (Pin. Abies)	-
fol. varieg.	0 3
péndula	2 6
pygmaea	5 0
Fraseri, hardy	0 6
Morinda, hardy	3 6
nobilis, hardy	60 0
hybrida (new), between A. excelsa, and Picea peccinata, hardy	21 0
nigra	0 3
Picea	0 3
fol. var.	0 6
torulosa	3 6
Pichte, hardy	5 0
rúbra, hardy	2 0

	s. d.
<i>Abies</i> (B.)	
<i>spectabilis</i> , doubtful	21 0
<i>millifolia</i>	
<i>Webbiana</i> , doubtful	21 0
<i>Cedrus</i> (C.)	
<i>Libani</i> rather tender, 25 years old, 90 feet high, and killed in the winter of 1829,	1 0—5 0
<i>Deodara</i> , stood out last winter 6°	30 0
<i>Larix</i> (D.)	
<i>archangelica</i> , received from Fischer	5 0
<i>europæa</i>	0 3
<i>microcarpa</i>	1 0
<i>pendula</i>	1 6
<i>Platanus</i>	
<i>Richardi</i>	1 6
<i>Platanus acerifolia</i> (grandifolia)	
<i>cuneata Willd.</i>	} 0 3—0 8
<i>occidentalis L.</i>	
<i>orientalis digitata</i>	
<i>Polygala Chamædixus</i>	1 0
<i>Populus</i>	
<i>alba</i> (nives) L.	0 3
<i>angulata balsamifera</i>	0 3
<i>béligæ Arembergi</i>	1 0
<i>betulifolia canescens</i>	0 9
<i>cordata</i>	0 9
<i>dilatata Willd.</i>	0 3
<i>graeca Willd.</i>	0 3
<i>heterophylla</i>	2 6
<i>lævigata Ait.</i>	1 0
<i>aurifolia Ledebour</i> , handsome species	4 0
<i>Lindleyana Booth</i>	0 9
<i>macrophylla</i>	0 9
<i>Medusa</i>	1 6
<i>monilifera</i>	0 3
<i>fol. aur. var.</i>	1 6
<i>nlgra</i>	0 3
<i>pannónica</i>	1 0
<i>suaevolepis Fischer</i>	5 6
<i>trémula</i> (pendula <i>Duroi</i>)	0 2
<i>pendula</i>	1 0
<i>vinifolia</i>	1 6
<i>Potentilla</i>	
<i>scorbunda</i>	0 6
<i>fruticosa L.</i>	0 3
<i>Prinos</i>	
<i>ambiguus</i>	1 6
<i>glaber L.</i>	0 6
<i>padifolius</i>	1 6
<i>verticillatus</i>	0 6
<i>Prunus</i>	
<i>armeniaca</i> (Arm. vulg.)	0 6
(ak-arigh) white apricot of Eriwan	4 0
<i>(fol. varieg.)</i>	2 6
<i>brigitata Vth.</i>	0 9
<i>candicans</i>	0 9
<i>canadensis</i>	2 6
<i>cerasifera</i>	
<i>Chicasa</i> (insititia <i>Walt.</i>)	0 6
<i>Coccoloba</i> Dec.	1 0
<i>cercola</i>	
<i>doméstica</i>	0 2
<i>f. pl.</i>	0 6
<i>fol. var.</i>	1 3
<i>pyramidalis</i>	1 0
<i>glomerata</i>	1 0

	s. d.
<i>Prunus</i>	
<i>hyemalis</i>	1 0
<i>maritima</i>	0 9
<i>nlgra</i>	1 0
<i>pygmaea Willd.</i>	0 9
<i>sibirica</i>	0 9
<i>sphærocarpa</i>	0 9
<i>spinosa</i>	0 3
<i>doméstica</i>	1 0
<i>f. pl.</i>	1 0
<i>fr. dulcis Booth</i> (new sweet) (C. Hort. T.)	3 0
<i>leucocarpa</i>	1 6
<i>Cerasus</i>	
<i>avium</i>	0 2
<i>flor. plen. maj.</i>	0 9
<i>serot.</i>	0 6
<i>fol. arg. var.</i>	1 0
<i>grandifolium</i>	1 0
<i>macrocarpum</i>	0 9
<i>oxycarpum</i>	1 0
<i>polygonum</i>	0 9
<i>var. asplenifol.</i>	0 9
<i>syvestre</i>	0 2
<i>depressa</i> (Susquehanna)	0 9
<i>fruticosa</i>	1 0
<i>Laurocerasus</i>	0 6
<i>fol. var.</i>	0 9
<i>salicifolia</i>	0 6
<i>luisitânica</i>	0 6
<i>Mahaleb L.</i>	0 4
<i>fr. flavo</i>	0 9
<i>Mardica Host</i>	1 0
<i>Palus</i>	0 2
<i>caroliniana</i>	0 6
<i>fol. var.</i>	2 0
<i>pendula</i>	1 0
<i>racemosa</i>	1 0
<i>rubra</i> (pumila)	1 0
<i>persicifolia Desfont.</i>	1 6
<i>pumila</i> (glauca)	0 6
<i>sativa</i>	0 3
<i>serotina</i>	0 3
<i>sempervirens</i>	0 6
<i>virginiana</i>	0 3
<i>Pterocarpa</i> , caucasica	0 6
<i>Ptelea trifoliata</i>	0 3
<i>Pyrus</i>	
<i>alpina</i>	
<i>Amelanchier W.</i> (<i>Mespilus</i>)	0 6
<i>florida</i>	2 0
<i>americana</i> (Sorbus)	0 9
<i>amygdaliformis</i>	1 0
<i>apetala</i> (dioica)	0 6
<i>arbutifolia</i>	0 4
<i>fr. nlgro</i>	0 6
<i>Asia IV.</i> (vide Sorbus)	0 3
<i>aucuparia</i>	0 3
<i>fr. luteo</i>	0 9
<i>atrovirens</i>	2 6
<i>baccata L.</i>	0 6
<i>Botryapium</i> (<i>Mesp.</i>)	0 4
<i>Chamæmispilus</i> (<i>Mesp.</i>)	0 6
<i>chinensis</i> (<i>P. Mal. chin.</i>)	0 6
<i>communis</i>	0 3
<i>fol. varieg.</i>	0 6
<i>f. pl.</i>	0 6
<i>semiplen.</i>	0 6
<i>striata</i>	0 6
<i>pendula</i>	1 0
<i>guercifolia</i>	0 6
<i>coronaria</i>	0 6
<i>Cydonia</i> (<i>Cyd. vul.</i>)	0 2
<i>chinensis</i> (<i>Cyd. chin.</i>)	0 9
<i>luisitânica</i> (<i>C. vul. luis.</i>)	0 6

	s. d.
<i>Pyrus</i>	
<i>doméstica</i> (v. Sorbus)	0 4
<i>edulis</i>	1 0
<i>clausenifolia Pallas</i>	1 0
<i>Hortii</i> Jac. fil.	1 6
<i>hyemalis</i>	1 0
<i>heterophylla</i>	5 0
<i>japonica</i> (<i>Cydonia</i>)	0 6
<i>f. albo</i> (<i>Cyd.</i>)	0 9
<i>intermedia</i> (<i>Sorbus</i>) <i>Willd.</i>	0 6
<i>linearis</i>	1 0
<i>Malus</i>	0 2
<i>acérta</i>	0 6
<i>astracantha</i>	0 6
<i>paradisaca</i>	0 2
<i>præcox</i>	0 6
<i>fol. var.</i>	0 9
<i>striata</i>	0 6
<i>melanocarpa Willd.</i>	0 6
<i>Michauxii</i>	0 9
<i>microcarpa</i>	0 6
<i>nepalensis</i>	0 6
<i>nivialis Willd.</i>	0 6
<i>ovalis</i>	0 6
<i>pinnatifida</i> (<i>Sorbus</i> hybr.)	0 6
<i>Polivaria Willd.</i>	0 6
<i>prunifolia</i>	0 6
<i>fr. coccineo</i>	0 6
<i>fr. coc. major</i>	2 6
<i>fr. luteo</i>	1 0
<i>fr. dulcis</i>	1 0
<i>fr. nlgro</i>	0 6
<i>fr. striato</i>	0 6
<i>fr. transpar.</i>	0 6
<i>fr. vfride</i>	0 9
<i>fol. var.</i>	0 6
<i>pubescens</i>	0 6
<i>salicifolia Willd.</i>	0 9
<i>sibirica</i>	1 0
<i>sinica</i>	0 9
<i>spectabilis</i>	0 6
<i>torrinialis</i> (<i>Sorbus</i>)	1 0
<i>upsaliensis</i>	0 6
<i>Quercus</i>	
<i>Ægiops L.</i>	2 6
<i>alba</i>	0 6
<i>ambigua</i>	0 6
<i>aquatica</i>	0 6
<i>Bantatai Mx.</i>	1 6
<i>bicolor</i>	0 6
<i>Castanea Willd.</i>	1 6
<i>Catesbevi</i>	2 0
<i>Cerris L.</i>	0 3
<i>dentata</i>	1 0
<i>fol. var.</i>	5 0
<i>cinerea M.</i>	0 9
<i>coccinea</i>	0 6
<i>discolor Willd.</i>	0 6
<i>falkenbergensi Booth</i>	3 6
<i>fastigiata</i>	1 6
<i>fulhamensis</i>	1 6
<i>grammuntia</i>	3 6
<i>heterophylla</i>	1 6
<i>Ilax</i>	0 9
<i>oblonga</i>	1 6
<i>Lucombeana</i>	2 6
<i>macrocarpa</i>	0 9
<i>maritima</i>	0 9
<i>Michauxii</i>	
<i>mongolica</i>	7 6
<i>montana</i>	1 0
<i>obtusifolia</i>	2 0
<i>oliveformis</i>	0 9
<i>palustris Mx.</i>	0 6
<i>pedunculata</i>	0 6
<i>Phellos Mx.</i>	1 0
<i>Prinos</i>	1 6
<i>pubescens</i>	2 6
<i>Robur</i>	0 3
<i>asplenifolium</i>	6 0
<i>fol. varieg.</i>	2 6
<i>natum</i>	1 6
<i>rubra</i>	0 6

	s.	d.
Quercus		
alba montana	0	6
sericea	1	0
stellata	1	6
Stueber	2	0
tinctoria	0	3
triloba	1	6
Rhamnus		
Astericus	1	0
argenteus	1	6
albus	1	6
maculatus	1	0
alnifolius	1	0
alpinus	0	6
major	2	0
catharticus	0	3
caucasicus	5	0
Erythroxylum	3	6
Fraxinea	0	3
hybridus	1	0
infectiorius L.	1	0
latifolius L'Herit.	1	3
p. minus Lindl.	3	6
prunifolius	5	0
rupicola Villars	2	6
saxatilis		
subsempervirens	1	6
Rhododendron		
arborescens hybridum	6	0
pallidum	6	0
azaleoides		
caucasicum		
latifolium		
lilacinum		
caucasicum		
caucasicoides		
danicum		
atrovirens		
ferrugineum		
fragrans		
hirtutum Dec.		
fol. var.		
hybridum		
maximum		
fl. albo	1	0—3 6
punctatum (minus)	1	0—3 6
according to size.		
punctatum		
album		
angustifolium		
arborescens		
daphnifolium*		
fol. adreia		
fol. argenteis		
grandifolium		
glomeratum		
latifolium		
magnoliifolium		
pumilium rotundifolium		
roseum		
undulatum		
Rhodora		
canadensis L.	1	0
Rhus		
aromatica (suavdolens)	1	3
copallina L.	0	9
Cotinus	0	3
elegans Willd.	0	6
glabra	0	4
leucantha	2	0
radicans	0	2
Toxicodendrum L.	0	2
quercifolium	0	9
typhina L.	0	4
arborescens	0	4
Vernix	0	9
viridiflora Poiret	1	6
Ribes (A.)		
alpinum	0	2
praecox	0	9
alpinum	0	3

	s.	d.
Ribes		
alpinum fr. nigro majus		
fr. nigro ovale		
fr. rubro		
sarant. majus	1	0
nigricans		
sanguineum		
caucasicum	10	6
caucasicum	1	0
fendicum	0	3
glandulosum	1	0
glandulosum	1	9
hirsutum	2	6
hirsutum	2	6
hirsutum	1	6
folium	0	3
nigrum	0	3
fol. var.	0	6
fr. viride	0	6
niveum	2	6
palmarum	1	0
petraeum	0	6
prostratum	0	6
recurvatum	0	6
rubrum	0	3
fr. albo	0	4
carneo	0	4
maximo	0	8
strato	0	4
fol. var.	0	6
aur. var.	0	6
sanguineum	0	4
atrosang.	2	0
pallidum	1	0
saratile	0	4
tenuiflorum	1	0
R. Grossularia		
Cynobatis	0	9
Diacantha	0	4
divaricatum	0	6
gracile	2	0
Grossularia		
fol. var.	2	6
monstruosum		
Booth	7	6
oxyacanthoides	0	3
punctatum	1	0
speciosum	1	6
triflorum	0	9
triste	2	6
Uva crispa	0	4
Robinia		
amorphaeifolia	0	9
dubia	1	0
gracilis	2	0
hispida	0	6
arborescens	0	9
infernalis	1	0
microphylla	1	0
procera	1	0
Pseudacacia	0	3
crispa (undulata)	1	0
echinata	1	3
fol. aur. var.	2	6
var.	2	6
speciosa (monstruosa)	9	0
tortuosa		
sophoraeifolia	0	9
stricta	1	0
viscosa	0	6
alba	1	3
hirsuta	1	3
volubilis	1	0
For others vide Caragana.		
Rosa		
47 species single and double roses, 1s. each		
1100 garden varieties, from 6s. to 2s. 6d.		

	s.	d.
Rubus		
affinis	0	6
americanus	0	6
arcticus	1	0
americanus	2	6
Beliana	0	6
caucasicus	0	9
carpathicus	0	9
Chamaemorus	2	6
dumetorum appropinquans		
discolor	0	9
nigrum	0	9
vulgaris	0	9
fruticosus	0	9
fruticosus	0	9
fr. albo, pl.	0	4
fr. rubro, pl.	0	9
fol. var.	0	9
fr. albo	0	9
hispidus	0	6
hispidus	0	2
fr. rubro	0	2
fr. rubro	0	2
fr. maximo	0	2
inermis Dec.	1	0
leucodermis	1	0
leucostachys	1	6
nididus	1	0
nuthanus	0	6
occidentalis	0	6
odoratus L.	0	4
pinetorum laciniatum)	0	4
pistillaris	1	6
pubescens	0	4
rubra	0	6
rhamnifolius	1	6
rubra	0	9
rubicus	0	9
rubicus	0	9
Scheucheri	0	9
spectabilis	0	6
Sprengelii	0	9
suberectus	1	0
sylvaticus	0	9
sylvaticus	1	0
vestitus ruber	0	6
vulgaris mollis	0	6
viridis	0	6
Ruscus		
aculeatus	0	4
Hypoglossum	0	6
laxus	3	6
racemosus	0	4
Salix		
ediantifolia Swetz (tobica)	1	6
Salix *		
acutifolia, masc.		
Willd.		
alba, masc. Lin.		
fem. Lin.		
Ammanniana		
ambigua		
amygdalina		
Androsolena, form. Schmidt, masc. Schmidt.		
annularis		
arbutula		
argentea, form. Sw.		
aurata, masc. Host.		
fem. Host.		
austriaca, form. Host.		
babylonica		
bicolor, masc. Ehrh.		
fem. Ehrh.		
candida, masc. Willd.		
canescens, masc. Willd.		
fem. Willd.		

* 6d. each except those priced.

Sàlix s. d.
càprea, masc. *Læs.*
carniòlica, masc. *Host.*
 fem. *Host.*
càsptica
cinèrea, masc. *Sm.*
 fem. *Sm.*
còncolor, masc. *Host.*
 fem. *Host.*
confèra, fem.
 Wang.
cotinifòlia, masc.
 Sm.
 fem. *Sm.*
Crowèana
decipiens
Dicksoniàna
discolor, masc. *Host.*
 fem. *Host.*
excelsior, masc.
 Host.
 fem. *Host.*
fagifòlia, masc.
 Kütz.
finnàrchica, fem.
 Willd.
Forbyàna *Sm.*
Forsteriàna, fem.
 Sm.
fragillor, masc. *Host.*
 fem. *Host.*
fragilla, masc. *Host.*
 fem. *Host.*
fragillissima, masc.
 Host.
 fem. *Host.*
glaucescens, masc.
 Host.
grisea, masc. *Host.*
Hèlix, masc. *Læs.*
 fem. *Læs.*
herbacea
heterophylla, fem.
 Host.
hippophæfol., masc.
 Thunb.
 fem. *Thunb.*
holosericea, masc.
 Willd.
Hoppèna, masc. *Willd.*
humilis, fem. *Willd.*
intermèdia, masc.
 Host.
 fem. *Host.*
Lambertiàna
lanceolata, fem. *Sm.*
laurina, fem. *Sm.*
Agustrifòlia, fem.
 Wendl.
Agustrina, masc.
 Host.
 fem. *Host.*
lùcida, masc.
 Muhl.
seenthæfolia, masc.
 Host.
 fem. *Host.*
Meyeriàna
miràbilis *Host.*
mollissima, fem.
 Ehrh.
monàndra, fem.
moschàta - 1 0
mutàbills, masc.
 Host.
 fem. *Host.*
nigra, masc. *Marack.*
nigrìcana, masc. *Sm.*
oppositifòlia, masc.
 Host.
 fem. *Host.*
ovàta, fem. *Host.*
palèstria, masc. *Host.*
 fem. *Host.*
parietariæfolia, masc. *Host.*
 fem. *Host.*

Sàlix s. d.
péndula, fem.
 Marack.
 (diversa a S. ba-
 bylón.)
pentàndra, masc. *Læs.*
 fem. *Læs.*
phylicæfolia, masc. *Læs.*
 fem. *Læs.*
pomerànica, fem.
 Willd.
Pontederàna, fem.
 Willd.
prostràta
prunifòlia, masc. *Host.*
 fem. *Host.*
purpùrea, masc. *Læs.*
 fem. *Læs.*
rèpens
reticulàta - 2 6
ripària, masc. *Willd.*
 fem. *Willd.*
rivalis, masc. *Host.*
 fem. *Host.*
ròsea álba - 2 0
sempèrflòrens, masc.
 Host.
 fem. *Host.*
Seringeàna, fem.
 Gaudin.
Smithiàna
spathulàta, fem.
 Willd.
speciòsa, masc. *Host.*
 fem. *Host.*
**spec. péndula* 1 6
tenuifòbra, masc.
 Host.
 fem. *Host.*
tenuifòlia, masc. *Sm.*
ténuis, fem. *Host.*
tétrapla, masc.
 fem.
tomentòsa, masc.
 Host.
 fem. *Host.*
tortàcea, masc.
 Schleich.
 fem. *Schleich.*
triàndra, masc.
 fem.
ulmifòlia, fem.
 Willd.
undulàta, masc.
 Ehrh.
 fem. *Ehrh.*
vària, masc. *Host.*
 fem. *Host.*
venùsta, masc.
 Host.
 fem. *Host.*
Villarsìana, masc.
 Willd.
viminàlis, masc. *Læs.*
 fem. *Læs.*
v. ràmis fuscis, masc.
 fem.
violàcea, fem. *Willd.*
vitellina, masc. *Læs.*
 fem. *Læs.*
canescens
v. ràmis adreis, masc.
 fem.
Wulfeniàna
Weigeliàna

Sambùcus
canadènsis - 0 4
hýbrida - 0 9
álga - 0 4
 fol. argent. var. 0 4
 fol. aur. var. 0 6
 fr. viride - 0 4
 laciniàta - 0 4
 heterophylla 4 6
 monstròsa 0 9
 pulverulènta 0 9

Sambùcus s. d.
racembosa - 0 3
rotundifòlia - 1 0
pubèns - 1 0

Smilax
rotundifòlia 0 6

Sèdum
populifòllum 0 3

Shephèrdia
Vide Hipp. canadènsis

Solànium
arbòreum - 1 6
Dulcamàra - 0 2
 fol. aur. var. 0 9
 fl. álbo 0 9
littoràle (Dulcamàra
 var. pubescens) 0 9
pèrsicum - 0 9

Sophòra
japònica *L.* 0 6
 fol. varieg. 5 0
 péndula 3 6

Sòrbus (Pyrus)
Ària (Pyrus) 0 3
américana - 0 6
aucupària *L.* 0 3
 fol. var. - 0 6
 fr. álteo - 0 9
doméstica - 0 6
hýbrida - 0 6
intermèdia 0 6
monstròsa - 2 0
nepalènsis - 2 0
terminalis - 1 6
spec. hýbrida
lá dubie, nameless 1 0 each.

Spàrtium
júnceum - 0 4
 fl. pl. 1 0
multifòrum - 0 6
radiàtum - 1 0
scopàrium (Genista) 0 3
álbida - 2 6
 fl. pl. - 2 6
 fol. varieg. 3 0

Spiràea
argèntea - 5 0
acutifòlia - 0 4
alpina *Pallas* 0 9
aristifòlia - 1 0
bèlla - 0 6
 álbida
betulæfolia - 0 9
carpinifòlia 0 6
chamædrifòlia 0 6
corymbòsa - 0 4
crenàta *L.* 0 6
cratægifòlia, *Link.* 1 6
 Hortul.
 fem.
decumbens - 3 6
Apyricifòlia *L.* 0 3
infèxa - 0 6
lævigàta *W.* 0 3
lanceolata - 1 0
mèdia (vèra) 1 6
nàna (càna) 1 0
oblongifòlia - 1 0
obovàta - 1 0
opulifòlia *L.* 0 3
 nàna 0 6

Plekovitènsis
salicifòlia - 0 3
 álba - 0 3
 mìnor - 0 6
 fol. varieg. 1 0
 ròsea - 1 0
 paniculàta 0 3
 ràbor viridus 0 6
 undulàta 1 0

	s.	d.
Spiræa		
sibirica	1	0
sorbifolia L.	0	8
dãtrica	1	6
thalictroides	0	3
tomentosa	0	3
trifolia	0	3
simifolia Scopoli	0	9
Staphylæa		
pinnata L.	0	3
trifolia L.	0	3
Styrax		
levigata		
Symphoria		
racemosa	0	4
glauca	1	0
montana	1	0
vulgaris	0	3
fol. varieg.	0	6
Syringa		
chinensis Willd.	0	3
fl. rubro	3	6
Josikma's	3	6
mædia	0	9
pærsica	0	3
flor. albo	0	6
flor. carneo	2	0
laciniata	0	6
spec. pterifolia	10	6
vulgaris L.	0	2
flor. rubro majori	6	
flor. semipl.	2	0
flor. viol.	0	3
fol. varieg.	3	6
sibirica	1	0
alb. virginialis	5	0
Tâmarix		
gãllica L.	0	3
libanotica	1	0
germãnica L.	0	3
taurica	3	7
Taxodium (Cupressus)		
disticum	0	6
pëndulum	2	6
Tãxus		
baccata L.	0	3
fol. varieg.	2	6
pyramidalis	1	6
canadensis	0	9
hibèrnica	0	6
Técoma		
Vide Bigonia		
Thuja		
cupressoides	1	6
occidentalis L.	0	3
orientalis L.	0	6
plicata	1	6
sphæróidea (Cupressus sphyoides)	0	6
tatarica	1	0
Wareana	1	0
Tilia		
americãna (grandifolia)	0	6
alba Bot. Kew.	0	6
nigra	0	6
canadensis	0	6

	s.	d.
Tilia		
europæa (vulgãris) L.	0	3
asplenifolia	0	9
aurea	0	9
corallina	0	6
fol. varieg.	1	0
parvifolia	0	9
laxiflora	1	0
obliqua	3	6
præcox	0	9
pyramidalis	2	6
sitifolia	7	6
pubescens	0	6
Ulex		
europæa	0	3
flor. plen.	0	6
provincialis	1	6
stricta	0	6
Ulmus		
alata	1	6
americãna	0	6
betuloides	0	6
campestris	0	3
fol. varieg.	0	4
corylifolia	1	0
crispa	0	6
incisa	1	0
effusa	0	9
exoniensis	1	3
fastigiata	1	0
filva (americ. pend.)	0	4
gigantea	0	6
glabra	1	3
glomerata Boott	2	0
microphylla	0	9
fol. var.	2	6
montana	0	6
nigra	0	6
pëndula	1	0
rugosa	1	0
Sampsoni	0	6
suberosa	0	3
fol. var.	0	6
sibirica	1	0
tortuosa	2	0
tiliifolia	3	6
viminalis	1	6
viscosa	1	0
Vaccinium		
album (stamneum)	0	9
Arctostaphylos	0	9
crassifolium	0	9
ericifolium minus	0	9
ericophalum	1	0
formeum	1	3
fuscatum	1	0
hæcidium (nitidum)	1	0
macrocarpum Willd.	1	0
fol. var.	1	6
Myrtillus		
fructu albo*	5	0
ovatum	1	0
Oxycoccus	0	3
ulliginosum	0	3
venustum	1	
Vitis idæa	0	6

* From the mountains of the Black Forest.

	s.	d.
Veronica		
hibèrnica	0	6
pãllida	0	6
Fiburnum		
casinoides		
dãtricum (vbera)	5	0
dentatum L.	0	3
longifolium	1	0
edible Boott	0	3
levigatum	1	6
Lantana	0	3
minor	0	6
lantandides	2	0
Lentago L.	0	3
microphylla	1	6
nitidum	1	6
nodum	1	0
O'pulus	0	3
rosea	0	3
fol. varieg.	1	6
parvifolium	1	0
prunifolium L.	0	6
pygmaeum	3	6
pyrifolium	1	0
Vinca		
major	0	3
fl. albo	5	0
minor	0	2
fol. arg. var.	0	3
fol. aur. var.	0	3
fl. purpureo	0	3
fl. purpureo pl.	0	3
Virgilia		
lutea	1	6-50
Vitex		
Agnus castus	0	9
incisa Willd.	0	9
Vitis		
alexandrina	1	0
arborea (Ampelopsis bipinnata)	0	9
cordifolia	0	9
Aederaces (Ampelopsis Aederacea)		
indivisa	1	6
hirsuta (Ampelopsis)	1	6
Labrusca	0	6
laciniata	0	6
odoratissima	1	6
palmetta	1	0
silicifolia	0	6
riparia	1	0
vilifera	0	6
virginiana	0	6
vulpina	0	6
Wistaria		
Vide Glycine		
Xanthorrhiza		
epifolia	0	2
Xanthoxylon		
straxineum	0	6
Xylosteum		
Vide Loniceus		
Ziraphus		
Vide Palurus.		

INDEX TO THE GENERA :

WITH THEIR

SCIENTIFIC SYNONYMES, POPULAR ENGLISH NAMES, ETC.

The small Roman numerals refer to the Contents, where will be found a scientific Synopsis of the Species and Varieties. The large Roman numerals refer to the volumes; and the Arabic figures refer to the pages of the body of the work, and of the Supplement. All the systematic Synonymes are indented, and all the Half-hardy Species are in small type.

A.
Aaron's Beard, I. 400. See *Hypéricum*.
Abele tree, III. 1638. See *Pópulus*.
Abelicea, III. 1413. See *Plána*.
Abies D. Don, cxxxvii. IV. 2105. 2293. See *Cèdrus*, *Làrix*, *Picea*, and *Cunninghàmia*.
Abietinae Richard, cxxxiii. IV. 2104. 2106.
Abrósius Dod., lxxxii. II. 1068. See *Artemisia*.
Abrinthium Lob., lxxxii. II. 1069. See *Artemisia*.
Abutilon *Bot. Mag.*, xxvi. I. 583. See *Sida*.
Acacia Willd., xlii. II. 662. IV. 2554.
Acacia, False, II. 609. See *Robinia*.
Acacia Fahl., xlii. II. 934.
Acacia L., xxx. I. 406.; IV. 2541. See *Negundo*.
Acetose Lindl., xxx. I. 405.
Acyras sp. Lin., xcv. II. 1192. See *Bumelia*.
Achyronia *Wend.*, xlvii. II. 646.
Acyron *Link.*, cli. III. 1232.
Adam's Needle, cxlv. IV. 2521. See *Yucca*.
Adelia Michx., cviii. III. 1370. See *Borya*.
Adelia L., cli. IV. 2583.
Adenocarpus *Dec.*, xlv. II. 603.; IV. 2552. See *Calophaca*.
Adamaia *Dec.*, xlvii. II. 645.
Adrachne of *Theophrastus*, lxxxvii. II. 1120. See *Arbutus*.
Adschynomene *Roxb.*, xlv. II. 609. See *Robinia*.
Baculaceae Lindl., xxxii. I. 462.; IV. 2543.
Æsculus, xxxii. I. 463.; IV. 2543. See *Favia*.
Agapites D. Don, xlv. II. 1175.
Agarista O. Don, lxxxviii. II. 1129.
Agatha's Cas., lxxxii. II. 1071. See *Cisneria*.
Agathia *Sal.*, cxl. IV. 2447. See *Dammara*.
Agave L., cxiv. IV. 2529.
Agéria *Adans.*, xxxvi. II. 580. See *Prinos*.
Agilantus *Desf.*, xxxiv. I. 487. 490.
Algaroba *Tree*, II. 661. See *Prosopis*.
Alaternoides *Walt.*, cxxxi. IV. 2058.
Alaternus, II. 629. See *Rhamnus*.
Alcornoque, *Spæ.*, III. 1911. See *Cork Tree*.
Alder, cxxiii. III. 1678.
Alexandrian Laurel, cxlv. IV. 2520. See *Ruscus*.
Alhagi *Desf.*, *Mamma* plant, xlviii. II. 646.
Allsaints' Cherry, II. 701.
Allspice *Tree*, lxix. See *Calycanthus*.
Almond *Tree*, II. 673.
Alnus *Tournef.*, cxxiii. III. 1677. See *Bétula*.
Aloube R. et P., cl. III. 1277.
Aloufa *Or.*, cli. III. 1286.
Althæa *Frutex*, I. 362. See *Hibiscus*.
Altingia *Hort. Brit.*, cxx. IV. 2440. See *Araucaria*.
Altingia *Noronha*, cxxxii. IV. 2049. 2054. See *Liquidambar*.
Alyssum, xxi. I. 313.
Ambrasia *Walsh*, lxxx. II. 1062.
Amelanchier *Med.*, lxxv. II. 673. 674.
American Allspice, lxxx. II. 936. See *Calycanthus*.
American Aloe, cxlv. IV. 2529. 2605. See *Agave*.
American Beech, III. 1980.
American Cranberry, II. 1170. See *Oxycoccus*.
American Elms, III. 1404. 1406.
American Hazel, cxxxii. III. 2030.
American Honeysuckle, II. 1140. See *Azalea nudiflora*.
American Hornbeam, cxxx. III. 2018.

American Laurel, II. 1151. See *Kalmia*.
American Mosay-cupped Oak, III. 1869.
American Rose Bay, II. 1134.
American Turkey Oak, III. 1803.
American Wayfaring Tree, II. 1037.
American White Oak, III. 1864.
Amomyrtus *Parsh.*, xcli. II. 1154.
Amorpha L., xlv. II. 606.
Ampelopsis *Micx.*, cxxxii. I. 477. 481.; IV. 2544. See *Pttis*.
Amygdalophora *Neek.*, xlix. II. 673.
Amygdalus *Tournef.*, xlix. II. 671. 673.; IV. 2554. See *Persica* and *Cerasus*.
Amyridaceae Lindl., xl. II. 561.
Amymis, xl. II. 561.
Anabasis L., cli. III. 1291.
Anacardiaceae Lindl., cxxxix. II. 545.
Anagyris L., cxlv. IV. 2549. See *Piptanthus*.
Anacardium *Lam.*, III. 1818. II. 954.
Andersonia *H. Br.*, lxxxiii. II. 1075.
Anacardium *Cus.*, lxxxvii. II. 1117.
Andróméda *L.*, lxxxv. II. 1077. 1105.; IV. 2574. See *Castope*, *Cassándra*, *Zenobia*, *Lydonia*, *Leucóthoe*, *Pteris*, *Phyllodoce*, *Dabec'cia*, *Arctostáphylos*, *Pernéttya*, *Agarista*, *Cyrilla*, *Bryánthus*, and *Vaccinium*.
Androsiphile *Wend.*, cx. I. 397. See *Cocculus*.
Androsæmum *Chois.*, xxx. I. 397. 408. See *Hypéricum*.
Angelica *Tree*, II. 998. See *Aralla*.
Angelonia *H. B. et Kunth*, cl. III. 1477.
Angophora *H. Br.*, lxxi. II. 960.
Anisæthkus *Willd.*, lxxxii. II. 1068. See *Symphoricarpos*.
Anisæth *Tree*, xviii. I. 356. See *Platanus*.
Anona *L.*, xx. 292. See *Asimina*.
Anonacæ, xx. I. 292.
Anonidis *Mauch.*, xlv. I. 604. See *Ononis*.
Anonymus *Walt.*, xviii. II. 647. See *Wistaria*.
Anthemis *Hort.*, cxlv. IV. 2573.
Anthoecia *H. Br.*, cl. III. 1277.
Anthocephalum *L.*, lxxxi. II. 1063.
Anthella *L.*, xlvii. II. 641.
Antus *Dow's Hill*, xli. II. 557.
Aptis *Pursh*, xviii. II. 647. See *Wistaria*.
Aplophyllum *And.*, xxxiv. I. 487. See *Rota*.
Apocynacæ, cxix. II. 1254.
Apple-bearing *Hose*, II. 753. See *Rosa* *villósa*.
Apple-bearing *Sage*, III. 1981. See *Sálvia pomifera*.
Apple-berry, I. 356. See *Billardiæra*.
Apple *Tree*, II. 891.
Apple *Tree* of *New Holland*, II. 960.
Apricot, II. 681.
Approporphora *Neck.*, lxxv. II. 879. See *Pyrus*.
Aquaria *Jacq.*, c. III. 1286. See *Solanum*.
Aquifoliacæ *Dec.*, cxxxvi. I. 505.
Aquifolium *Tournef.*, cxxxvi. I. 505. See *Plex*.
Araliacæ, lxxv. II. 998.
Aralla *L.*, lxxv. II. 998.
Araucaria *R. et P.*, cxl. IV. 2105. 2432.
Arbor *Vitæ*, cxl. IV. 2454. See *Thuja*.
Arbutus *Cam.*, lxxxvii. II. 1077. 1117.; IV. 2575. See *Arctostáphylos*, *Pernéttya*, *Gaulthéria*, and *Phalero-carpos*.
Arctostáphylos *Adans.*, lxxxviii. II. 1078. 1123.; IV. 2575. See *Arbutus*.
Arcebia *L.*, lxxxii. II. 1072.
Arénaria *W.*, xxvi. I. 359.

- Argania* Roem. et Schultes, xciv. II. 1191.
Arya L'Obel, lxvii. II. 910.; IV. 2566. See *Pyrus*.
- Aristolochiaceae*, cvii. III. 1328.
Aristolochia L., cvii. III. 1328.
Aristotelia L'Hérit. xxxix. II. 543.
Armenacea Tournef. l. II. 671. 681.; IV. 2554.
Aronia Pers., lxviii. II. 925. See *Pyrus*, *Ame-lanchier*, and *Crataegus*.
- Aronia* Thorn, II. 837.
 Arrow-wood, II. 1038. See *Ulmum*.
Artemisia Cass., lxxxii. II. 1064, 1068.
Arundo L., cxlv. IV. 2532.
Asclepiadaceae, cxix. III. 1257.
 Ash Tree, cxvii. II. 1213. See *Fraxinus*.
 Ash Berberry, xxi. I. 308. See *Mahonia*.
 Ash-leaved Maple, I. 460. See *Negundo*.
Asimina Adams, xx. I. 292.; IV. 2536.
 Aspen, III. 1645.
Asper Lab., lxxxiii. II. 1073.
Asplena Bot. Reg., lxxxii. II. 1070. See *Heliophyllum*.
- Astrachan* Apple, II. 893. See *Pyrus*.
Astragalus Dec., xlvii. II. 637.
Astranthus Lour., xxxix. II. 544.
Aspalathus L., xlvii. II. 641.
Asparagus L., cxlii. IV. 2516.
Aspalathus D. Don, lxxxiii. II. 1073.
Athanasia L., lxxxiii. II. 1073.
Atragene L., xlviii. I. 246. See *Clematis*.
Atriplex L., ciii. III. 1288, 1289.
Aucuba Thunb., lxxvii. II. 1026.; IV. 2571.
Aurantiaceae, xxix. I. 395. IV. 2540.
Aurantium, xxix. I. 395. See *Citrus*.
Avelanus, III. 2016. See *Corylus*.
 Avignon Berries, II. 533. See *Rhamnus*.
Ayryis L., ciii. III. 1290. See *Diotis*.
Azalea D. Don, xcii. II. 1078, 1153.; IV. 2576.
Azalea L., lxxxix. II. 1140. See *Rhododendron*.
 Azalea, common, II. 1140.
 Azara R. et P., xxxix. II. 544.
 Azarole Thorn, II. 826.
Azardus, II. 826. See *Crataegus*.
Azedarack, I. 476. See *Melia*.
- B.
- Baccharis* R. Br., lxxxii. II. 1063, 1066.
Baccharis L., lxxxii. II. 1072. See *Brachyotus*.
Baccharis Andr., lxxd. II. 961.
 Balm of Gilead Tree, II. 561. See *Balsamodendron*.
 Balm of Gilead Tree, *Amer.*, iii. 1676. See *Pepulus* *candicans*.
 Balm of Gilead Fir, cxxxix. IV. 2339. See *Picea* *balsamea*.
 Balsam Poplar, III. 1673.
Balsamaceae, cxxxix. IV. 2048.
Balsamita Desf., lxxxiii. II. 1074.
Balsamodendron Kunth, xl. II. 561.
 Bamboo, cxlv. IV. 2532.
Banksia R. Br., cv. III. 1306.
 Banksian Roses, II. 777.
Baptisia L., xli. II. 566.; IV. 2549. See *Piptanthus*.
Birch *Jovis* *Musch.*, xlvii. II. 641. See *Anthyllis*.
 Barbadoes Cedar, IV. 2504. See *Juniperus* *barbadensis*.
 Barcelona Nut, cxxx. III. 2018. See *Corylus*.
 Barron Scrub Oak, III. 1889. See *Quercus* *Catesbeiana*.
Bartlingia Bromm., xxxix. II. 542, 1062. See *Plocama*.
 Base Broom, II. 563. See *Genista* *tinctoria*.
 Basket Osier, III. 1492. See *Salix* *Forbydiana*.
 Bastard Acacia, II. 609. See *Robinia*.
 Bastard Box, I. 356. See *Polygala* *Chamaebuxus*.
 Bastard Cherry, II. 701. See *Cerasus* *Pseudocerasus*.
 Bastard Cork Tree, III. 1917. See *Quercus* *Pseudo-süber*.
 Bastard Cytisus, I. 312. See *Melia*.
 Bastard Indigo, II. 606. See *Amorpha*.
 Bastard Quince, II. 928. See *Pyrus* *Chamaemespilus*.
Bauxgarria *Musch.*, xx. I. 298. See *Coccolus*.
 Bay, Sweet, ciii. III. 1296.; Cherry, iii. II. 714. 716.
 Bead Tree, xxxiii. I. 476. See *Melia*.
- Bean-Caper, I. 484. See *Zygophyllum*.
 Bear Oak, III. 1893. See *Quercus* *ilicifolia*.
 Bearberry, II. 1123. See *Arctostaphylos*.
 Bear's Grape Whortleberry, II. 1163. See *Fac-cinium*.
Beaufortia R. Br., lxxi. II. 857.
 Beech, cxxix. III. 1949.
Becharia Humb. et Boiss., xciv. II. 1173.
Beckia *Media*, xciv. II. 1173.
Beckia *Salsab.*, cxl. IV. 2445. See *Cunninghamia*.
 Bellücia *Adams*, xxxiv. I. 499. See *Ptelea*.
 Benjamin tree, III. 1303. See *Laurus* *Benzoin*.
 Benthämia Lindl., lxxvii. II. 1009, 1019.
 Benoän C. G. Nees *Von Esenbeck*, cv. III. 1203.
Berberaceae Lindl., xx. I. 298.; IV. 2536.
Berberis L., xx. I. 299.; IV. 2536.
 Berberry, xx. I. 299. See *Berberis*.
 Berberry-leaved Rose, II. 613. See *Löwes*.
 Berchémia Neck., xxxvii. II. 528.
 Berchémia W. Linn., II. 1073.
 Bermudas Cedar, cxlii. IV. 2498. See *Juniperus*.
 Berry-bearing Alder, III. 537. See *Rhamnus* *Frangula*.
Betulaceae, cxxiii. III. 1677.
Betula *Tournef.*, cxxiii. III. 1690. See *Alnus* and *Fagus*.
Bétulus *Lob.*, cxxx. III. 2004. See *Carpinus*.
Bignonia *Sm.*, cviii. III. 1370. See *Borys*.
Bignoniaceae, c. III. 1258.
Bignonia *Tournef.*, c. III. 1258. See *Catalpa*, *Tecoma*, and *Celastrum*.
 Bilberry, II. 1156. See *Farctinum*.
Bimberbia *Sm.*, xxvi. I. 356. See *Sedum*.
 Billiea R. Br., lxxd. II. 961.
 Birch, cxxiii. III. 1690.
 Bird Cherry, II. 709.
 Bird's-eye Maple, I. 411.
 Birthwort, III. 1329.
 Bitter Oak, III. 1846. See *Quercus* *Cerris*.
 Black Apricot, II. 683.
 Blackberry, II. 742.
 Black Gum, III. 1317.
 Black Irish Elm, III. 1398.
 Black Jack Oak, III. 1890, 1898.
 Black Oak, III. 1894.
 Black Scrub Oak, III. 1899.
 Black Thorn, II. 685.
 Black Walnut, III. 1435.
 Black willow *Des. saxos.*, II. 544.
 Bladder-nut Tree, I. 493.
 Bladder Senna, II. 685.
 Bleasberry, II. 115.
 Bleas's, lxxv. II. 1091.
 Blue Gum Tree, II. 968, 969. See *Eucalyptus*.
 Bois de Ste. Lucie, II. 707.
Bonapertia *Horn.*, cxlv. IV. 2523. See *Litsea*.
 Bonduc, II. 696. See *Gymnocladus*.
Boraginaceae, c. III. 1263.
Borbonia L., xlvii. II. 640.
Borbonia *Planch.*, cv. III. 1259. See *Laurus* *carolinensis*.
Boronia *Sm.*, cxlv. IV. 2544.
 Borys W., cviii. III. 1343, 1370.
 Bosses L., cii. III. 1291.
 Bossie's Vent., xlvii. II. 610.
 Bouvardia H. B. et Kunth, lxxxi. II. 1068.
 Bow-wood, III. 1362. See *Macidura*.
 Box Elder, I. 460.
 Box Thorn, III. 1269.
 Box Tree, III. 1333.
 Box, Dwarf, III. 1333.
Brachyotus *Sw.*, lxxxi. II. 1072.
Brachyotus *R. Br.*, xli. I. 567.
 Bramble, II. 723. See *Rubus*.
 Breda Apricot, II. 683.
 Brignole Plum, II. 689.
 British Oak, III. 1731.
 Broom Hickory, III. 1449.
 Broom, the common, II. 595.
 Broom Tree of Van Diemen's Land, cxlv. II. 569.; IV. 2568.
Broussonetia *Vent.*, cviii. III. 1342, 1361. See *Morus*.
Brunfelsia *R. et P.*, c. III. 1374.
Brunfelsia *R. Br.*, xxxix. II. 542.
Brunfelsia *Gertn.*, cii. III. 1296.
Bryanthus *Gmel.*, xciv. II. 1171.
Bucania *L'Hér.*, lxxxi. II. 1062.
 Buck's Horn. See *Rhus*.
 Buckthorn, II. 529. See *Rhamnus*.
 Buckeye, I. 468. See *Pavia*.

Buddlea L., cl. III. 1276.
 Bull Grape. See *Vitis rotundifolia*.
 Bullace, II. 687. See *Prunus inasititia*.
Bumelia Swartz, xcv. II. 1192.
Bupleurum Tourn., lxxv. II. 997.; IV. 2570.
Bursera Kunth, xl. II. 951.
Bursaria Cav., xxvi. I. 359.
Burtonia R. Br. xli. II. 567.
 Butcher's Broom, cxliv. IV. 2517. See *Ruscus*.
 Butter Nut, III. 1439. See *Carya*.
 Button-wood, II. 1061.; IV. 2043. See *Cepha-*
lanthus.
 Button Tree, IV. 20, 43. See *Platanus occiden-*
talis.
Buxus Tourn., cvii. III. 1330. 1332.

C.

Cacalia L., lxxviii. II. 1072. See *Calcectium*.
Calceolom, lxxii. II. 967.; IV. 2569.
Calceus, II. 967. See *Opuntia*.
Calce L'Hérst., xlix. II. 660.
Calceolaria Ait., xlix. II. 660.
Calampella D. Don, c. III. 1263.
Calceolaria L., cl. III. 1277.
Calceolaria Voss, lxxviii. II. 1072.
 Calico Bush, II. 1151.
 Calico Flowers, II. 1151. See *Kalmia*.
Calligonum L., ciii. III. 1292, 1295.
Callista (Erica L.) Bot. Cab., lxxvii. II. 1089. 1091.
Callistemon Dec., lxxi. II. 960.
Callitachys Sims, xli. II. 567.
Callitris Forst., cxli. IV. 2105, 2462.
Calluna Sol., lxxvii. II. 1076, 1084.
Calophaca Fisch., xlvii. II. 635.
Calothidium R. Br., lxxii. II. 957.
 Calycanthaceæ *Lindl.*, lxxix. II. 935, 936.; IV. 2566.
Calycanthus L., lxxix. II. 936. See *Chimonán-*
thus.
Calycotome Link, xlv. II. 597. See *Cytisus*.
Calycotis, R. Br., lxxii. II. 964.
Camellia L., xxviii. I. 281.; IV. 2540.
 Campanulacæ, lxxxi. II. 1063.
Campanula L., lxxxi. II. 1063.
 Camphor Tree, III. 1305.
Camphorosma Sokk. ciii. III. 1291.
Camarium König, xl. II. 561.
 Candleberry Myrtle, cxxvii. IV. 2055.
 Canoe Birch, III. 1708.
 Canoe-wood, xix. I. 284. See *Liriodendron*.
Cassia Jusq., c. III. 1274. See *Vicia*.
 Cape Heath, List of lxxvii. II. 1089. 1091.
 Cape Phillyrea, II. 504. See *Cassine*.
 Caper Bush, I. 313.
 Cappariaceæ *Lindl.*, xxi. I. 313.
Capparis L., xxi. I. 313.
Capparis L., cl. III. 1377.
 Caprifoliaceæ, lxxviii. II. 1026.
Capprifolium L., lxxix. II. 1045. See *Lonicera*.
Capparis Gerard. cl. III. 1266.
Caragana, xlv. II. 629.; IV. 2552. See *Hali-*
modendron.
Carlowitzia Mench., lxxvii. II. 1072.
Carmichaelia R. Br., xlvii. II. 642.
 Carob tree, II. 660. See *Ceratonia Siliqua*.
 Carolina Poplar, III. 1670.
Carpinus L., cxxx. III. 2004. See *Ostrya*.
Carpodacus Forst., xxvii. II. 542.
 Carthaginian Apple, II. 939. See *Pomegranate*.
Carya Nutt., cxi. III. 1421, 1441.
 Caryophyllaceæ, xxvi. I. 359.
Casia Camer., cvii. III. 1320.
Cassandra D. Don, lxxvii. II. 1377. 1108.
Cassia L., xlix. II. 650.
Cassia Ham., lxxix. III. 1933. See *Quercus semi-*
carpifolia.
Cassine L., xxxv. II. 508.
 See *Celastrus*, II. 495.
 See *Elæodendron*, II. 504.
 See *Ilex*, II. 518.
 See *Prinos*, II. 521.
 See *Viburnum*, II. 1035.
Cassiope D. Don, lxxvii. II. 1077, 1107.; IV. 2574.
Cavendishia LA., xxxii. I. 459.
Castanea Tourn., cxxx. III. 1983. See *Fagus*.
Castanopernum Cuscutaceæ, xlix. II. 660.
 Casturacæ, cxxxii. IV. 2060.
Casuarina, cxxxii. IV. 2060.
Catalpa Jusq., c. III. 1258. 1261.
Cavendishia Lindl., xciv. II. 1173.
Ceanothus L., xxxviii. II. 539.; IV. 2537. See
Scutia, *Colubrina*, and *Willemétia*.

Cedar of Goa, cxli. IV. 2477. See *Cupressus*
lusitanica.
 Cedar of Lebanon, cxl. IV. 2402. 2603.
 Cedar, Red, IV. 2495. See *Juniperus virginiana*.
 Cedar, White, IV. 2475. See *Cupressus thyoides*.
Cedrus Barret., cxli. IV. 2108. 2402.
Cedrus Tourn., cxli. IV. 2467. See *Juniperus*.
 Celastracæ *Dec.*, xxxv. II. 495.
Celastrus L., xxxv. II. 502.; IV. 2545. See
Magnus.
Celaia Jacq., cl. III. 1277. See *Alonabo*.
Celtis Tourn., cx. III. 1413.
 Cembra, IV. 2274. See *Pinus*.
Cephalanthus L., lxxxi. II. 1061.
Ceramia (Erica L.) Ledeb., lxxvii. II. 1089.
Cerasus Juss., li. II. 672. 692.; IV. 2556. See
Prunus.
Ceratola Mr., cxliii. IV. 2506. 2508.
Ceratolida Tourn., ciii. III. 1250.
Ceratonia L., xli. II. 650.
Ceratopernum Pers., ciii. III. 1290.
Cerastema R. et P., xciv. II. 1173.
Cercis L., xlviii. II. 687.
Cercocarpus R. B. et Knuth, lxxix. II. 934.
Cérise, cxxv. III. 1846.
Cérus Dalech., cxxv. III. 1846.
Cestrum L., cl. III. 1274.
Chenopodium Lindl., lxxviii. II. 921.
Chamaeborus, I. 266. IV. 2538. See *Polygala*.
Chamaecerasus Pers., lii. II. 702. See *Lonicera*.
Chamaecerasus, lxxx. II. 1050. See *Lonicera*
 and *Xylotum*.
Chamaecistus Clus., xxiv. I. 246. See *Helian-*
themum pilosum.
Chamaedaphnoides Alpin., cr. III. 1312. See
Daphne oleoides.
Chamaefistula Don's Mill., xlix. II. 661.
Chamaeliadum Zwgf., lxxii. II. 964.
Chamaelidion Link., xcii. II. 1153. See *Azalea*
 ~ *D. Don*.
Chamaemepilus Dec., lxxviii. II. 926.
Chamaemorus, See *Rubus*.
Chamaerhododendron Tourn., lxxxix. II. 1180.
 See *Rhododendron*.
Chamaerops L., xciv. IV. 2530.
Chamaixis, xlv. II. 629. See *Caragana*.
 Champion Oak, III. 1877. See *Quercus rubra*.
Characias. See *Euphorbia*.
 Chaste Tree, III. 1285.
Chelidonium, xxi. I. 313, 369.; IV. 2538.
 Chenopodiaceæ, cii. III. 1267.
Chenopodium L., cii. III. 1288.
 Cherry, II. 629.
 Cherry Birch, III. 1713.
 Cherry Crab, II. 893.
 Cherry-fruited Pincelce, III. 1315.
 Cherry Plum, II. 688.
 Chestnut, III. 1983.
 Chestnut Oak, III. 1737. See *Quercus Prinus*.
 Chestnut of New Holland, II. 660. See *Castano-*
spermum australe.
 Chicaw Plum, II. 705.
 Chimonanthus, lxxix. II. 935. 937.; IV. 2566.
 China Roses. See *Rosa*.
China Bauh. &c., cxliv. IV. 2513.
 China Root, IV. 2513. See *Smilax*.
 Chinese Cherry, II. 701. 706.
 Chinese Crab, II. 909.
 Chinese Tree, I. 249. See *Pæonia*.
Chionanthus L., xcvi. II. 1098, 1205.
 Chittim-wood, III. 1639.
 Choke Cherry, II. 703. 704.
Chorizanthe R. Br., xli. I. 357.
 Christ's Thorn, II. 527.
Chrydocoma L., lxxviii. II. 1072.
Chrysophyllum Aubl. and others, xcv. II. 1192.
 See *Bumelia*.
Cinchona Patr., lxxxi. II. 1062. See *Laricia*.
Cineraria Lessing, lxxii. II. 1064. 1071.
 Cinnamon Tree, III. 1307.
Cissampelos Champere Swt., cv. III. 1305.
Cissampelos L., xx. I. 237. See *Menispermum*.
Cissus L., xxxiii. I. 477. 483. See *Ampelopsis*.
Cistaceæ Lindl., xxi. I. 316. IV. 2538.
Cistus L., xxi. I. 317.; IV. 2538. See *Helian-*
themum and *Hudsonia*.
 Citronelle, II. 1068.
 Citrons, I. 286.
Citrus L., xlix. I. 395.
 Claret Grape, I. 478.

- Clématis L.*, xvii. II. 232; IV. 2535. See *Atrágene*.
Cleodándrum R. Br., ed. III. 1286. See *Volkameria*.
Cléthra L., lxxxviii. II. 1078. 1127.
Cléthrus Soland., xlviii. II. 646.
Cliffortia, lxi. II. 935.
Cluytia Bot. Mag., cvii. III. 1341.
Clymenon L'Obel, xxx. I. 403. See *Androsæ'mum*.
Coburn L., xl. II. 560.
Coburnæ, c. III. 1264.
Coburn's Cav., c. III. 1264.
Coba's Neck, lxxx. II. 1050. See *Lonicera* & *Xylósteum*.
Cob Nut, cxxxii. III. 2018. See *Corylus*.
Cocculus Bauh., xx. I. 297. See *Wendlandia*.
Cockspur Thorn, II. 820.
Coff de Hook of Arn., lxxviii. II. 1039.
Collitia, xxxix. II. 541. See *Retanilla*.
Colúrna, III. 2029. See *Corylus*.
Colubrina Brongn., xxxix. I. 542.
Colútea R. Br., xvi. II. 635; IV. 2552. See *Calóphaca* and *Sutherlandia*.
Colymbæa Sal., cxi. IV. 2432. See *Araucária*.
Compósita, lxxxiii. II. 1063.
Composita, cxxxii. IV. 2059.
Coondale Cav., xxxix. II. 541.
Condylocarpus Salisb., cxli. IV. 2480. See *Taxodium*.
Coniferae, or *Pinacæ*, cxxxiii. IV. 2103.
Constantinople Hazel, cxxxii. III. 2029. See *Corylus Colúrna*.
Convolvulacæ, c. III. 1264.
Convolvulus L., c. III. 1264.
Conyza Jacq., lxxxiii. II. 1072.
Copper-coloured Beech, III. 1950, 1951. See *Fagus*.
Coral Tree, II. 649. See *Erythrina*.
Córchorus Thunb., llii. II. 722. See *Kérria*.
Cordáceæ, c. III. 1265.
Coréna D. Don, cxliii. IV. 2506. 2508.
Coriáceæ, xxxiv. I. 492.
Coriária Nées, xxxiv. I. 492.; IV. 2545.
Cork Tree, III. 1911. See *Quercus Süber*.
Cornacæe L., lxxvi. II. 1009.
Cornel, II. 1014.
Cornelian Cherry Tree, II. 1014.
Cornish Elm, III. 1376.
Cornish Moor Heath, II. 1082.
Córnus L., lxxvi. II. 1009, 1019.; IV. 2571. See *Benthámia*.
Coronilla Neck., xlvii. II. 643.
Corn's Sm., cxiv. IV. 2544.
Corrida Cass., cxliv. IV. 2516. See *Aspáragus*.
Corylacæ, or *Cupuliferae*, cxv. III. 1715.
Corylus L., cxxxii. III. 1716. 2016.
Costorphine Plane, I. 414.
Cotinus, II. 849. See *Rhus*.
Cotoneáster Med., lxx. II. 673. 869.; IV. 2563.
Cotton Tree, III. 1652. 1670. 1672.; IV. 2043. See *Pópulus* and *Pistánus*.
Cotton-wood, III. 1655. See *Pópulus canadensis*.
Cowale D. Don, cxiv. IV. 2557.
Cowdie Pine, IV. 2447. See *Dámmara*.
Cowberry, II. 1164.
Crab, common, II. 892.
Crab, sweet-scented, II. 908.
Crab, transparent, II.
Crack Willow, III. 1516. See *Salix frággilis*.
Cranberry, II. 1168. See *Oxycoccus*.
Crasuláceæ, lxxii. II. 965.
Cratæ'ga Lindl., lxi. II. 813.; IV. 2562. See *Photinia*, *Rhaphiôlepis*, *Ameláncier*, *Pýrus* (*A'ria*, *torminálie*, *Arónia*, and *Chame-méspilus*), *Eriobótrya*, and *Stranvæ'sia*.
Cress Rocket, I. 312. See *Véila*.
Crista-gállii, II. 649. See *Erythrina*.
Crotalaria xlvii. II. 640.
Croton Cass., cxiv. IV. 2585.
Crowberry, cxliii. IV. 2506.
Crowns Sm., cxiv. IV. 2544.
Cruciáceæ, xxi. I. 312.
Cruciferae, xxi. I. 312.
Crús-gállii, II. 820. See *Cratæ'gas*.
Cryptandra Swida, xxxix. I. 542.
Cuckold Nut, cxxxii. III. 2030. See *Corylus americana*.
Cucumber Tree, xix. I. 273. See *Magnólia*.
Cuellária R. et P., lxxxviii. II. 1127. See *Cléthra*.
Culcétrum, lxxxiii. II. 1074.
Cellúria R. Br., lxxxii. II. 1072.

- Cuninghamia R. Br.*, cxi. IV. 2105, 2445.
Cupressinae, cxi. IV. 2452.
Cupressus L., cxli. IV. 2105, 2464. See *Thüja*, *Araucária*, *Calítrix*, *Taxodium*, *Schubertia*, and *Juniperus*.
Curled Maple, I. 496.
Currant, Red, II. 977.
Currant, Black, II. 983.
Custard Apple, xx. I. 292.
Cut-leaved Alder, III. 1678.
Cut-leaved Beech, III. 1951.
Cut-leaved Oak, III. 1735.
Cyathodes Labd., lxxxii. II. 1075.
Cyclops R. Br., xli. I. 567.
Cydónia Tourne., lxxvii. II. 929.
Cypress, *Deciduous*, IV. 2480. See *Taxodium*.
Cypress, *Evergreen*, cxli. IV. 2464. 2605. See *Cupressus*.
Cypress Poplar, III. 1660. See *Pópulus fastigiata*.
Cytis L., cxiv. IV. 2577.
Cytisus Dec., xliii. II. 588.; IV. 2550. See *Genista*, *Adenocarpus*, and *Calóphaca*.

D.

- Dabo'cia*, lxxxvii. II. 1077. 1116.
Dactyldium Solander, cxxxii. IV. 2100.
Dáhhle Cav., lxxx. II. 1072.
Dahoon Holly, II. 519.
Damaak Roses, II. 759. 781.
Dámmara Rumph., cxi. IV. 2105. 2447.
Dammar Pine, IV. 2447. See *Dámmara*.
Dandolo's Mulberry, III. 1349.
Dáphne L., cix. III. 1307.
Darwinia Rad., lxxii. II. 964.
Dasyanthus (Erica L.) Andr. Heath, lxxxiv. II. 1089.
Date of Trebissonde, II. 1149. See *Diospyros Lötus*.
Date Plum, II. 1194.
Datura arborea Hort., c. III. 1274. See *Brugmansia*.
Daviesia R. Br., xli. II. 567.
Deciduous Cypress, cxli. IV. 2480. See *Taxodium*.
Decumária L., lxxi. II. 955.
Deodára, IV. 2428. See *Cedrus*.
Deodar Cedar. See *Deodára*.
Derris G. Don, xli. II. 661.
Désma (Erica L.) Andr. Heath, lxxxiv. II. 1089.
Desmodium Dec., xlvii. II. 643.; IV. 2562.
Deutzia, lxxxi. II. 956.; IV. 2567.
Devil-wood, II. 1208.
Dewberry, II. 730.
Dianthus L., xxvi. I. 359.
Dicentra Dec., xlvii. I. 645.
Dichilus Dec., xlvii. II. 641.
Dióctis E. P., lxxxii. II. 1072.
Diervilla Tourn., lxxxix. II. 1037. 1042. See *Lonicera*.
Dilleniacæ, xix. I. 299.
Dillwynia Smith, xli. I. 567.
Diospyros L., xc. II. 1164.
Dióttis Schreb., ciii. III. 1248. 1250.
Dirca L., cv. III. 1807. 1394.
Dischidia Hook., xxxix. I. 541.
Diostma Dec., lxxii. II. 965.
Dotsona, xxxii. I. 462.
Dodonæ's L., xxxiii. I. 476.
Dog Roses, II. 267.
Dogwood, II. 496. See *Eucnymus*.
Dogwood, II. 1009. See *Córnus*.
Dogwood, male, II. 1014. See *Córnus mas.*
Dolichos Thunb., xlvii. II. 648. See *Wickström*.
Dombéya Lamb., cxi. IV. 2432. See *Araucária*.
Donar, IV. 2532. See *Arundo*.
Donia G. et D. Don, xlviii. II. 646.
Dool Tree, IV. 2542.
Doronicum Tourne., xlvii. I. 630.
Double Chinese Almond, II. 706.
Double Chinese Cherry, II. 701.
Double dwarf Almond, II. 706.
Double-flowered Cherry, II. 689.
Dracocarpalum Cass., cii. III. 1283.
Dracopis R. Br., lxxxii. II. 1075.
Drypis, xxvi. I. 359.
Duke of Argyle's Tea Tree, III. 1263, 1270. See *Lycium*.
Dulcamára, III. 1266. See *Solanum*.
Duranta Hort., cii. III. 1286.

Durmast Oak, III. 1737.
 Dutch Beech, III. 1639.
 Dutch Elm, III. 1395, 1396.
 Duvaña Kth., xl. II. 558.; IV. 2649.
 Dwarf Chestnut, III. 2002.
 Dwarf Chestnut Oak, III. 1875.
 Dwarf Fan Palm, IV. 2530. See Chamæ'rops.
 Dwarf Jagged Oak, III. 1892.
 Dwarf Medlar, II. 928.
 Dwarf Red Oak, III. 1893.
 Dyer's Broom, II. 543.
 Dyer's Weed, II. 583.
Egobda Lour., lxxxi. II. 1062.

E.

Eagle's Claw Maple, I. 410.
 Ebenacæ, xcv. II. 1194.
Ebenus L., xlviii. II. 646. See Anthyllis.
E'benus Comm., xcv. II. 1194. See Diospýros.
Eccremocarpus Fendl., c. III. 1863. See Calampella.
Echium L., c. III. 1865.
E'cua (Erica), lxxv. II. 1091.
Edwardia Miers, xli. II. 567.
 Eglantine (Sweet Briar), II. 765. Honeysuckle, III. 1648.
 Egyptian Poplar, III. 1640.
Ehrbia Benth., III. 1265.
Ehrbia L'Herit., cl. III. 1273. See Grabókwia.
 Elæagnacæ, cvi. III. 1320.
Elæagnus Tourn., cvi. III. 1320, 1321.
Elæagnus Carl., cxxiii. IV. 2066.
Elæodendron Spreng., xxxvi. II. 504. See Hartógia.
Elæodendron Retz., xciv. II. 1192. See Argémia.
Elæagnum Lob., cli. III. 1265.
 Elder, II. 1027.
 Elm Tree, III. 1873.
Embryopteris L., scv. II. 1197.
Emmenia Mill. lxxx, xlii. II. 644. See Coronilla.
 Empetracæ, cxliii. IV. 2606.
Empetrum L., cxliii. IV. 2606.
Empetrum L., cxliii. IV. 2608. See Coréma.
 Enklánthus *Lour.*, xciv. II. 1172.
 Epacridacæ, lxxxi. II. 1075.; IV. 2673.
Epactis Sm., lxxxi. II. 1075.
Epigæa L., lxxxviii. II. 1078. 1126.; IV. 2675.
E'phedra L., cxxxi. IV. 2062.
Epinotum Alp., cxxxi. IV. 2065.
 Ericacæ, lxxxi. II. 1076.; IV. 2674.
Erica D. Don, lxxxi. II. 1076. 1079.; IV. 2674.
 See Calluna, Gyppocállia, Phyllidocæ, Dabec'cia, Menstéria.
 Eriobotrya *Lindl.*, lxxx. II. 933.; IV. 2556. See Mésplis and Photinia.
Eriocapalus L., lxxxi. II. 1072.
Eriocoma D. Don, lxxxi. II. 1072.
Eriobolus Dec., lxxv. II. 915.
Erythrina L., xlviii. II. 649.
Erythroxylon, II. 534. See Abámus.
 Escalloniadæ, lxxv. II. 992.
Escallonia Mutis, lxxv. II. 993.; IV. 2570.
E'sculus, III. 1844. See Quercus.
E'dbasis Salisb., lxxvii. II. 1026.
Eucalypta, lxxi. II. 958.; IV. 2567.
Euchlus R. Br., xli. II. 567.
Eucodia R. Br., lxxi. II. 958.
Euonymus Tourn., xxxv. II. 495, 496.; IV. 2545.
Euonymus Thunb., xvi. I. 538. See Pittosporum.
Euonymoides Mench, xxxv. I. 502.
Euonymus Nutt., civ. III. 1303.
 Euphorbiacæ, cvii. III. 1330.
Euphorbia L., cvii. III. 1331.
Eurya Royle, xlix. I. 935.
Eurytea (Erica L.) *Wendl. Arce.*, lxxv. II. 1089.
Eurytea (Erica L.) *Bot. Cab.*, lxxv. II. 1091.
Eutassa Sal., cxl. IV. 2432, 2440.
Eutaxia R. Br., xli. I. 569.
 Evergreen Beech, III. 1982.
 Evergreen Honeysuckle, II. 1048.
 Evergreen Magnolia, xix. I. 261.
 Evergreen Oak, III. 1899.
 Evergreen Thorn, II. 844.
 Evergreen Turkey Oak, III. 1851.
 Everlasting, II. 1070.
 Exeter Elm, III. 1399.

F.

Fabago, I. 484. See Zygophyllum.
Fabricia, II. 961. IV. 2667. See Leptospermum.

Fagra Lam., xxiv. I. 488.
Fagatum G. Don, xl. I. 561.
Fagus L., cxxix. III. 1715, 1949. See Castanea and Cárpinus.
 False Acacia, II. 609. See Robinia.
 Fan Palm, cxlv. IV. 2530. See Chamæ'rops.
 Feaberry, II. 972. See Gooseberry.
 Feabas, or Feapes, II. 972.
 Female Cornel, II. 1010.
Ficus Tourn., cviii. III. 1248, 1265.
 Fig Marigold, II. 966. See Mosembryánthemum.
 Fig, Indian, II. 967.
 Fig Tree, III. 1865.
 Filbert, cxxxi. III. 2017.
 Fir Tree, cxxvii. IV. 2293, 2599.
Fischera Swartz., xcii. II. 1154.
 Five-leaved Ivy, xxxiii. I. 482.
Flammula Dill., xvii. 238.
Flamingia Roxb., xlv. II. 646.
 Florence Court Yew, cxxxi. IV. 2066.
 Flowering Ash, II. 1241.
 Flower-fence, IV. 2554. See Poinciána.
 Fly Agaric, III. 1704.
 Fly Honeysuckle, II. 1060.
Fontanisia Labill., xcvi. II. 1198, 1213.
 Forbidden Fruit, IV. 2033.
Forstilla *Wall.*, lxxi. II. 965. See Decumária.
Fothergilla L., lxxvi. II. 1008.
Fouquieria Kar., cxlv. IV. 2547.
Fovinia *Bot. Mag.*, cl. III. 1277.
Frangula *Tourn.*, cxxviii. II. 537.
Franklinia *Marsh.*, xxviii. I. 380.
Fraxinus W., lxxxii. II. 1072.
Fraxinus *Tourn.*, xcvi. II. 1198, 1213.; IV. See Ornus.
 French Plums, II. 689.
 French Willow, III. 1499.
Fremedia Mirbel., cxli. IV. 2462.
 Fringe Tree, II. 1205. See Chionánthus.
Fuchsia L., lxx. II. 944.; IV. 2566.
 Fulham Oak, III. 1850.
 Furze, xli. II. 571. See *Ulex*.
 Fustic-wood, III. 1361. See *Broussonetia*.

G.

Gale *Ray*, cxxxi. IV. 2056, 2056. See Myrica.
 Gall Oak, III. 1928. See Quercus infectória.
Gardoula Benth., cli. III. 1282.
 Garryacæ cxxxi. IV. 2031.
Garrya *Doug.*, cxxxi. IV. 2031.
Gastrolobium *Kar.*, xli. I. 567.
 Gatten tree, II. 1010. See Euónymus.
Gaultheria L., lxxxviii. II. 1078, 1125, 1127.; IV. 2575. See Oxycoccus.
Gaylussacia H. B. et Knuth, xdv. II. 1173.
 Gean, II. 693. See Cerasus.
Geisium *Michx.*, xxi. II. 1256.
Genista *Lam.*, xli. II. 877.; IV. 2550. See Stauracánthus, Spártium, *Ulex*, *Cytisus*, and *Adenocarpus*.
Georgia, II. 1072. See Dáhlia.
Gemistoides *Mench* *Meth.*, xlii. I. 584.
Gemistella *Mench*, xlii. I. 584.
 Geraniacæ, xxiv. I. 482.
Geranium, I. 482.
 German Tamartak, II. 949.
 Germander, III. 1279. See *Tedcrissum*.
 Ghent Asaleas, II. 1143.
 Giant Ivy, II. 1000.
 Ginkgo tree, cxxxi. IV. 2094. See *Salisbúria*.
Glans (*Erri*) *Daloch.*, cxxvi. III. 1861.
 Glasswort, III. 1288. See *Salisbúria*.
 Glastonbury Thorn, II. 823, 828, 829. See *Cra'tæ'gus*.
Gleditschia L., xlviii. II. 630.
 Globulariacæ, cli. III. 1287.
Globularia L., cli. III. 1287.
Glyche L., xlviii. II. 647. See *Wistaria* and *A'pina*.
Gnaphalium L., lxxxi. II. 1070. See *Heli'chrysum*.
Gnetacæ, cxxxi. IV. 2062.
Gnidia, cv. III. 1515.
 Goat's Thorn, II. 637. See *Astrágalus*.
 Golden Oslar, III. 1828. See *Salix*.
 Goldylocks, II. 1073. See *Chrysocoma*.

Compositum Smak, xii. II. 367.
Crota Sw., xvi. II. 740.
 Gooseberry, II. 572. See *Ribes*.
Goosefoot, III. 1204. See *Chenopodium*.
Gordonia Ellis, xxviii. I. 374; IV. 2540.
 Gorse, xli. II. 571. See *Ulex*.
Gouais Jacq., xxxix. II. 512.
Grabowskia Schlecht., cl. III. 1256. 1273.
Granadilla, II. 565. See *Passiflora*.
Granataczek D. Dom, ixix. II. 539.
Granatum, II. 539. See *Punica*.
 Grape Vine, I. 477.
Grabowskia, cxlv. II. 1566; IV. 2562.
 Great shrubby Horsetail, cxxxiii. IV. 2063. See *Ephedra*.
 Green Ebony, II. 1219.
 Green Weed, II. 563. See *Rhizinus tinctoria*.
 Green Wood, II. 563.
Grevillea Cunn., civ. III. 1306.
Grevia L., xviii. I. 376; IV. 2540.
 Grey Oak, III. 1891.
 Grey Wilby, III. 1653.
 Gripping Wild Service, II. 913.
Grossularia Dec., lxxii. II. 967.
Grossularia, lxxii. II. 967. See *Ribes*.
 Ground Cherry, II. 702.
 Groundsel tree, II. 1065.
 Guava tree, lxxi. II. 961.
Gustafina Tourne., xcv. II. 1194.
 Guelder Rose, II. 1039. See *Fiburnum*.
Gulandria L., xlviii. II. 656. See *Gymnocladus*.
 Gum Cistus, I. 317, 327.
 Gum Copal Rhus, II. 554.
 Gum tree, American, III. 1317. See *Nyssa*.
 Gum tree, Australian, II. 2554. See *Eucalyptus*.
Gymnocladus Lam., xlviii. II. 656.
Gypsocalia Sal., lxxxiii. II. 1082.

H.

Hackberry, III. 1419. See *Celtis*.
 Hagberry, II. 709. See *Prunus Párus*.
Halesiacea, xciv. II. 1189.
Halesia Ellis, xciv. II. 1189.
Halmus Ger. Emac., ciii. III. 1290.
Halleria L., cl. III. 1277.
Halesium Dec., xvi. I. 634.
Hamamelidaceae, lxxv. II. 1006.
Hamamelis L., lxxv. II. 1006, 1007; IV. 2570.
 See *Fothergilla*.
Hamedia Pucari MSS., lxxxii. II. 1060. See *Leycesteria*.
 Hare's Ear, II. 997. See *Eupleurum*.
Hartogia Dec., xxxvi. II. 504. 716.
 Hawthorn, II. 829; IV. 2562. See *Crataegus*.
Hastonia Caly, lxxxii. II. 1072.
 Hazel, cxxxii. III. 2016. See *Corylus*.
 Heath, II. 1084. See *Erica*.
 Heather, II. 1084. See *Calluna*.
Hedera Swartz, lxxv. II. 999; IV. 2570. See *Aralia* and *Ampelopsis*.
 Hedgehog Holly, II. 507.
 Hedge Nettle, III. 1281. See *Stachys*.
 Hedge Rose, II. 766. See *Rosa arvensis*.
Hedysarum, xlvii. II. 645.
Hedysarum L., xlvii. II. 646. See *Alhagi*, *Adamaia*, and *Desmodium*.
Heimia, lxx. II. 945.
Helianthemum Tourne., xxii. I. 317. 328; IV. 2539. See *Cistus* and *Hudsonia*.
Helichrysum Lessing, lxxxii. II. 1064. 1070. See *Gnaphalium* and *Stachys*.
Heliotropium L., c. III. 1265.
 Hemlock Spruce, cxxxvii. IV. 2322. See *Abies canadensis*.
 Herb of Grace, I. 468. See *Ruta*.
Hemrodium Desf., cl. II. 680.
Hibbertia, xix. I. 424.
Hibiscus L., xxvi. I. 261; IV. 2538.
 Hickory tree, III. 1441. 1444. See *Carya*.
Hicorius Rafinesque, cxi. III. 1451.
 Himalayan Oaks, III. 1933.
Hippocastanea Dec., xxxii. I. 462.
Hippocrepis Jacq., xvii. II. 645.
Hippophae L., cvl. III. 1321. 1324. 1327. See *Symphoricarpos*.

Hog Nut, III. 1449. See *Carya porcina*.
 Holly, xxxvi. II. 505.
 Holly Rose, I. 317. See *Helianthemum*.
 Holm Oak, III. 1869. See *Quercus Ilex*.
 Holy tree, II. 245. See *Ilex Aquifolium*.
 Homalinacea Lindl., xxxix. II. 542.
 Honey Berries, III. 1414.
 Honey Flower, I. 484. See *Melastomaceae*.
 Honey Locust, II. 659. See *Glottichia*.
 Honeysuckles, II. 1042. See *Lonicera*.
 Hop Horbeam, cxxxii. III. 2015. See *Ostrya*.
 Hornbeam, III. 2004. See *Carpinus*.
 Hornbeam of Nepal, cxxxii. III. 2013.
 Horsetail, I. 463. See *Equisetum*.
 Horse-tail Tree, IV. 2060. See *Casuarina*.
Hortensia, II. 936. See *Hydrangea*.
 Hottentot Cherry, II. 504. See *Cassia*.
Houstonia Desf., lxxxi. 131. 1052. See *Horradia*.
 Howe R. Br., xiv. II. 639. See *Plagiobolium*.
Hovenia Thunb., xxxix. I. 541.
Hudsonia L., xxv. I. 317. 354.
 Huntington Elm, III. 1404.
 Huntington Willow, III. 1522.
Hydrangea L., lxxv. II. 994.
Hymenanthus Benth., xciv. II. 1173.
Hyperanthus Vahl, xviii. I. 636.
Hypericaceae Lindl., xxix. I. 266; IV. 2541.
Hypericum L., xxix. I. 267; IV. 2541. See *Androsace*.
Hypocipium Thunb., xvii. I. 640.
 Hyslop, III. 1278.
Hysopus L., cl. III. 1278. See *Stachys*.

I.

Iberis, xxi. I. 312; IV. 2538.
Ilex L., xxxvi. II. 505; IV. 2545. See *Myrica*, *Prinos*, and *Nemophytes*.
Ilex Tourne., cxxiv. III. 1715. See *Quercus Ilex*.
 Illidium, xviii. I. 256.
Incarvillea Spreng., c. III. 1260.
 Indian Asclepias, II. 1148.
 Indian Lilac, I. 476. See *Melia*.
 Indian Thorn, II. 923. See *Raphiölepis*.
 Indian Physic, xix. I. 376.
 Indigo, II. 642.
Indigofera L., xvii. II. 642.
 Irish Heath, II. 1116. See *Daboecia*.
 Irish Ivy, II. 1000.
 Irish Yew, cxxxiii. IV. 2066.
 Iron Bark Tree, II. 954. See *Eucalyptus*.
 Iron Oak, III. 1846, 1870.
 Iron-wood, II. 961. See *Leptospermum*.
 Iron-wood, II. 1192. See *Argemone*.
 Iron-wood, Amer., cxxxii. III. 2016. See *Ostrya virginica*.
Isoetes Murch., lxxxii. II. 1056. See *Lonicera*.
Ischa Adams, lxxx. II. 1050. See *Lonicera*.
Issatis, lxxxiii. II. 1073.
 Italian Beech. See *Quercus Fecula*.
 Italian May, II. 726.
 Italian Oak, III. 1844.
 Italian Yellow Jasmine, II. 1249.
Itea L., lxxiv. II. 992. See *Cyrilla*.
Iva L., lxxxiii. II. 1064. 1066.
 Ivy, common, II. 999.
 Ivy, Five-leaved, I. 481. See *Ampelopsis*.

J.

Jackalin R. Br., xii. II. 567.
Jacobaea Bomp., lxxxii. II. 1071.
 Japan Honeysuckle, II. 1051.
 Japan Laurel, II. 1026.
 Japan Oaks, III. 1935.
 Japan Quince, or *Eriobotrya japonica*, II. 933.
 Japan Quince, or *Cydonia japonica*, II. 931.
 Japan Rose, I. 391. See *Camellia*.
 Japan Yew, cxxxiii. IV. 2100.
Jasminaceae, xcix. II. 1248.
 Jasmine, II. 1248.
Jasminodes Niss., cl. III. 1269. 1274.
Jasminum Forsk., xcix. II. 1248.
 Jerusalem Sage, III. 1279. See *Philomis*.

Johnson's Willow, III. 1519.
 Judas Tree, II. 657. See *Cercis*.
 Juglandæce, cx. III. 1420.
 Juglans L., cx. III. 1420, 1421. 1451. See *Carya*
 and *Pterocarya*.
 Jujuba, II. 524. See *Zizyphus*.
 Jujube Tree. See *Zizyphus*.
 Jullibrasin, xlix. II. 665. See *Acacia*.
 June Berry, II. 874. See *Amygdalier*.
 Juniperus L., cxlii. IV. 2106. 2487.
 Juniper, cxlii. IV. 2489, 2605. See *Cupressus*
 and *Cedrus*.
 Jupiter's Beard, II. 641. See *Anthyllis*.

K.

Kadsura, xx. I. 295.
Kageneckia R. et P., lxi. II. 934; IV. 2566.
Kahikatea, cxxxiii. IV. 2102.
 Kaki, IV. 1197. See *Diospyros*.
Kalmia L., xcii. II. 1079, 1161.
Kampmannia Rafn, xxxiv. I. 488.
 Kawaka in New Zealand, IV. 2102.
Kedz Pall. cxxxvii. IV. 2275.
 Kennedy's Vent., civr. IV. 2553.
 Kentish Cherry, II. 698.
 Kentucky Coffee Tree, II. 656. See *Gymno-*
cladus.
 Kermes Oak, III. 1908.
Kérria Dec., liii. II. 672. 722; IV. 2565.
 Kidneybean Tree, II. 647.
Kibbia Schr., cii. III. 1891.
Kilreuthria Lax., xxxliii. I. 475.
Kranbia Rafn, xviii. I. 647.
 Krumbolz, IV. 2186.

L.

Labiæce, ci. III. 1278.
 Labrador, or Scrub, Pine, IV. 2190.
 Labrador Tea, II. 1129. 1155.
Labiæca, I. 477. See *Pitis*.
 Laburnum, common, xliii. II. 590; IV. 2550.
 Laburnum, Scotch, xliii. II. 590.
Lacathea Sal., xxviii. I. 280.
Lagonychium Bieb. Supp., xlix. I. 661.
Lagerstræmia, lxx. II. 945.
Lampyrus Don's Mill., lxxiv. II. 1089.
Lambæ L., ci. III. 1877.
 Larch, IV. 2350. See *Larix*.
Laricio, cxxxiv. IV. 2200. See *Pinus*.
Larix Toura., cxxxix. IV. 2105. 2350. See
Pinus and *Abies*.
 See *Cedrus*, cxi. IV. 2402.
Lauræce, ciii. III. 1296.
 Laurel, Cherry, II. 716. See *Cerasus*.
 Laurel, common, II. 716.
 Laurel, Spurge, III. 1309.
Lauræola, III. 1309. See *Daphne*.
Laurocerasus, II. 716.
Laurus Pin., cii. III. 1296.
Laurus Cæmpera L., civ. III. 1305.
Laurus Cævia Bæ. Mag., civ. III. 1305.
Laurus Cinnamomeum L., civ. III. 1305.
 Laurustinus, II. 1032.
Lavandula L., cii. III. 1281.
Lavatera L., xxvi. I. 360.
 Lavender, III. 1281.
 Lavender Cotton, II. 1066. See *Santolina*.
 Leadwort, III. 1287. See *Plumbago*.
 Leafless Furze, II. 576. See *Stauracanthus*.
 Leather-wood, III. 1814. See *Dicca*.
Lebæcia Thunb., xviii. II. 641.
Lædum L., xcii. II. 1078. 1154; IV. 2576. See
Amygdaline.
 Leguminæce, xlix. I. 661.
Lelophyllum Pers., ccli. II. 1078. 1154.
 Lemon, I. 896.
 Lemon-scented Verbena, III. 1296. See *Aloÿ-*
sia citriodora.
Leucago Dec., lxxviii. II. 1033. See *Piburnum*.
Leucobis R. Br., cii. III. 1283.
Leucocæ, II. 547. See *Pistacia*.
Leucodan, xxi. I. 315.
Leptopernum, lxxi. II. 961; IV. 2547.
Leptodæ Michx., xviii. I. 646.
Leucæria Dec., xviii. I. 645.
Leucopogon R. Br., lxxviii. II. 1075.
Leucosthæ D. Don, lxxvii. II. 1077. 1113.

Lever-wood, cxxxi. III. 2015. See *Ostrya*
virginica.
Leycesteria Wall., lxxxi. II. 1127, 1060.
Ligustrum Toura., xc. II. 1198.
 Lilac, II. 1209.
Liliæce, cxiv. IV. 2515.
Lilæceum, cxvi. II. 1212.
 Lime Tree, xxvii. I. 364; IV. 2539.
 Limes, I. 396.
Limonia, xxix. I. 295.
Linæce, cxvi. I. 360.
 Linden Tree, IV. 2539.
 Ling, II. 1094.
Linum L., xxvi. I. 360.
Liparia L., xviii. II. 640.
Lippia Kunth, cii. III. 1286.
Liquidambar L., cxxxii. IV. 2049.
 See *Altingia Blume*, cxxxii. IV. 2154.
Liriodendron L., xix. I. 284; IV. 2526.
Lisæthe R. Br., lxxviii. II. 1075.
Lithospermum L. c., III. 1265.
Litsea Brig., cxiv. IV. 2589.
 Live Oak, III. 1918. See *Quercus virens*.
Lobeliaceæ, lxxxi. II. 1063.
Lobelia Ait., lxxxi. II. 1063.
 Loblolly Bay, I. 379.
 Locust, Honey, II. 650. See *Gleditschia*.
 Locust Tree, *Amer.*, II. 609.
 Locust Tree, *Russ.*, I. 406.
Loddigesia Sims, xviii. II. 641.
Loiseleuria Desf., xcii. II. 1163. See *Asalea*.
 Lombardy Poplar, III. 1666.
Lonicera Desl., lxxxi. II. 1027. 1042; IV. 2572.
 See *Caprifolium*, *Diervilla*, *Synphoricarpos*,
 and *Xylostemma*.
Lonicæce, lxxxi. II. 1041.
Lophandra (Erica L.) Andr. Heath., lxxv. II. 1091.
Lophospermum D. Don, ci. III. 1277.
 Loquat Tree, II. 933.
Loranthæce, lxxvii. II. 1020; IV. 2571.
Loranthus L., xviii. II. 1026; IV. 2571.
 Lote Tree, III. 1414.
 Lotos, European, II. 1194.
 Lotus of the *Lotophagi*, II. 526.
Lotus, xviii. II. 642.
Lötus sive Cætia Cam., cx. III. 1414.
Löwea Lindl., lxi. II. 812. See *Barberry-leaved*
Rose.
 Lucombe Oak, III. 1851. See *Quercus Cærris*.
Lucilia Swt., cxlv. IV. 2573.
Lupinus Sims, xviii. II. 649.
 Lupine Tree, II. 649.
Lycidæce Lin. Hort. Cliff., xc. II. 1193.
Lycium L., ci. III. 1266. 1269. See *Grabows-*
kia, ci. III. 1274.
Lydia, lxxvii. II. 1077. 1109; IV. 2574.
Lysinema R. Br., lxxviii. II. 1075.
Lythraceæ, lxx. II. 945.

M.

Maclura Nutt., cviii. III. 1342. 1362.
 Macquarrie Harbour Vine, III. 1296.
 Maggio, *Ital.*, II. 890. See *Laburnum*.
Magnoliæce Dec., xix. I. 250.
Magnolia L., xix. I. 250; IV. 25. 36.
 Mahaleb, II. 707. See *Prunus*.
Mahonia Nutt., xxi. I. 308; IV. 2537. See
Berberis.
Malachodendron Cav., xxvii. I. 377. See
Stuartia.
 Mallow, IV. 2538.
Malus Dec., lxvi. II. 891; IV. 2564. See
Pyrus.
Málva, IV. 2538.
Malvæce, xxvi. I. 360.
Mandula Cham. et Schleich., lxxxi. II. 1062.
Mangliëtia, xix. I. 251.
Mangilia Pers., cxlv. IV. 2578.
 Manna, xviii. II. 646. See *Aldagi*.
 Manna Ash, II. 1241.
 Maple, I. 405.
 Marryckus *R. et P.*, lxi. II. 934.
 Marron Chestnuts, III. 1984.
 Match Tree, II. 647. See *Pistacia*.
Maurandya Jacq., ci. III. 1277.
Maurocænia Mill., xxxv. I. 504.
 May. See *Crataegus Oxycantha*.
 May Duke Cherry, II. 693.

- May, Italian. See *Spiraea hypericifolia*,
 May Flowers, II. 1140.
Máytenua Forst., xxxv. II. 503.
Medicago L., xiv. II. 642.
 Medlar, II. 877, 928.
Meladora Sal., xiv. II. 1172.
Melaleuca, lxi. II. 957.
Mélla, xxxiii. I. 476.
Meliáceae, xxxiii. I. 476.
Melánthus L., xxxv. I. 484.
Melilotus Cantagne in Litt., xiv. I. 642.
 Melongéna Tourne., c. III. 1266.
Memécium Michx., lxxxviii. II. 1126.
 Menispermáceæ Dec., xx. I. 296.
Menispermum L., xx. I. 296. See *Cócculus*.
Menziesia Smith, xcii. II. 1078, 1152.
 See *Daboecia*, lxxxvii. II. 1115.
 Merry tree, II. 693. See *Cérasus*.
Mesembryacées, lxxii. II. 965.
Mesembryanthemum, II. 965.
Mespilóphora sp. of Neck., lxxvi. II. 877.
Méspilus Lindl., lxx. II. 672, 877. See *Cra-*
tægus, *Photinia*, *Cotoneáster*, *Amelánchier*,
Pýrus (*Aria*, *aucupária*, *spúria*, *Arónia*,
 and *Chamaméaplus*), *Raphiolépis*, and *Eri-*
obótýra.
Metrosideros, lxxi. II. 960. See *Callistemon* and *Lep-*
topýrum.
 Mexican Oaks, III. 1941.
 Mesercon, III. 1307.
 Mezérum, III. 1307. See *Dáphne*.
Michália, xix. I. 291.
 Milkmaid Holly, II. 608.
 Milk Vetch, II. 637.
 Milkwort, I. 356.
Mimosa L., xlix. II. 602. See *Achia*.
Mimulus Willd., c. III. 1277.
 Minorca Box, III. 1341.
 Minorca Holly, II. 616.
Mirbália Smith, xli. I. 567.
 Missouri Silver Tree, III. 1323.
 Missouri Yellow Currant, II. 991.
 Mistletoe, II. 1021.
 Mocker Nut, III. 1444.
 Mock Orange, II. 950.
Mongórium Lam., xcix. II. 1248.
Monóca R. Br., lxxxii. II. 1075.
 Moonseed, I. 296.
 Moor Heath, II. 1082.
 Moose-wood, I. 407.
 Morello Cherry, II. 693.
Morgána L., xxxiv. II. 484.
Mórus Tourne., cvii. III. 1342, 1343. See *Brous-*
sonétis and *Maclúra*.
 Mossy-cupped Oak, III. 1846, 1869.
 Mossy-cupped Oak, American, III. 1869. See
Quercus oliviformis.
 Mountain Ash, II. 916. See *Pýrus aucupária*.
 Mountain Laurel, II. 1151.
 Mountain Mahogany, III. 1713.
 Mountain Tea, II. 1125.
 Moutan, xviii. I. 250.
Mucosa Wall., xviii. II. 649.
 Mulberry Tree, III. 1343.
Múschie Dumort., lxxxi. II. 1063. See *Campanula*.
Mussaenda Ham., cl. IV. 2575.
Mutisia D. Don, lxxxiii. II. 1072.
Myginda Jacq., xxxvi. I. 505.
Myopórina, cl. III. 1287.
Myoporum R. Br., cl. III. 1287.
Myricáceae, cxxxii. IV. 2055.
Myrica L., cxxxii. IV. 2055.
 See *Rhús suaveolens*, xl. II. 657.
 See *Comptonia*, cxxxii. IV. 2059.
 Myrobalan Plum, II. 688.
Myrobálanus. See *Frónus*.
Myrsine L., cxiv. IV. 2578.
Myrtáceae, lxxi. II. 966.
Myrtillus Bauh., xcii. II. 1157. See *Faccinium*.
 Myrtle Billberry, II. 1156. See *Faccinium*.
 Myrtle, common, II. 961.
 Myrtle-leaved Beech, III. 1983.
 Myrtle Tree of Van Diemen's Land, III. 1982.
Myrtus L., lxxi. II. 968; IV. 2568.
 See *Myrica*, cxxxii. IV. 2056.
- N.
- Nábea Alp.*, xxxvii. II. 526.
- Nandina* Thunb., cxiv. IV. 2537.
Nápeca Lam., xxxvii. I. 526.
 Napoleon's Willow, III. 1511, 1514. See *Sáliz*
babylónica var.
Nátria Moench, xiv. I. 605.
 Nectarine, II. 680.
Negúndium, I. 406.
Negúndo, xxxi. I. 405, 460; IV. 254.
Nellie D. Don, xxxi. II. 344.
Nemopánthes Raf., xxxv. II. 2545.
 Nepal Oaks, III. 1920.
 Nepal Yellow Jasmine, II. 1949.
Nerium Oleander L., xcix. II. 1225.
 Nettle Tree, III. 1413. See *Céltis*.
 New Jersey Tea. See *Ceanóthus*.
 New Zealand Tea.
 Nicker Tree, II. 656. See *Gymnocladus*.
Nicotiana Grah., c. III. 1274.
 Nightshade, III. 1266. See *Solanum*.
Nintóda Swt., lxxx. II. 1050. See *Lonicera*.
Nitrariáceae Lindl., lxxii. II. 966.
Nitrária L., lxxii. II. 966.
 Norfolk Island Pine. See *Araucária excelsa*.
 Norway Maple. See *Acer platanóides*.
 Norway Spruce. See *Abies*.
Notéla Vent., cxiv. IV. 2579.
 Nut Tree, III. 2019. See *Corylus*.
Nús Jágla Dod., cxi. III. 1423.
Nycsermia B. Don, c. III. 1277.
Nycitérium Vent., c. III. 1266.
Nýssa L., cv. III. 1315, 1316.
- O.
- Oak, III. 1717. See *Quercus*.
 Oak, Holly-leaved, III. 1933, 1936.
 Oaks, American, III. 1864.
 Oaks, Himalayan, III. 1933.
 Oaks, Japan, III. 1935.
 Oaks, Japanese, III. 1926.
 Oaks, Mexican, III. 1941.
 Oaks, Nepal, III. 1920.
Odosémón Raf., xxi. 306.
Odera Thunb., lxxdii. II. 1072.
Óenópia Hed., xxxvii. II. 528. See *Zizyphus*
 and *Berchémia*.
 Ogechee Lime, III. 1318. See *Nýssa*.
 Oldfield Birch, III. 1707. See *Bétula populif-*
olia.
 Old Man, II. 1068. See *Artemisia*.
Olea L., xcvi. II. 1207. See *Olive*.
Oleáceae, xcvi. II. 1104.
 Oleander, II. 1256.
 Oleaster, III. 1321. See *Elmágnus*.
Oléine, xcvi. II. 1197, 1198.
Óléis Thunb., xxxix. II. 542.
 Olive, II. 1207. See *O'lea*.
 Olive-wood, II. 804. See *Elmódéndron*.
Omagracée Lindl., lxx. II. 942.
Ombrobus Link., lxxdii. II. 1072.
Óndis L., xlv. II. 604.
 Ontario Poplar, III. 1676.
O'páuis, xxxi. I. 421. See *A'cer*.
O'páuis Tourne., lxxviii. II. 1029. See *Fibúr-*
num.
Opántia Mill., lxxii. II. 967.
 Órache, III. 1269.
 Orange Tree, I. 396.
Orychócarpum Mx., xx. I. 292.
 Oriental Plane, cxxxii. IV. 2033. See *Plátanus*.
Órnus Pers., cxviii. II. 1193, 1241. See *Fráxinus*.
 See *Arpinus*, cxxx. III. 3004.
 Órage Orange, III. 1362.
 Ósier, common, III. 1549.
 Ósier, Golden, III. 1528.
Oscopérum L., lxxdii. II. 1072.
O'strya Willd., cxxx. III. 1716, 2015. See *Cár-*
pinus, cxxx. III. 3004.
Ostrya L., cv. III. 1316, 1320.
Othónna Bot. Cab., lxxdii. II. 1072.
 Over-cup Oak, III. 1871. See *Quercus lyrata*.
Oxyacantha, II. 829. See *Hawthorn*.
Oxycedrus Clus., cxlii. IV. 2494. See *Juni-*
perus, *Oxycedrus*, and *Lýcium*.
Oxybóccum Cord., cxiv. II. 1168.
Oxybóccus Pers., xciii. II. 1078, 1168. See
Phalerocárpus.
Oxybléium R. Br., xli. I. 567.

P.

Pachyrhizus Des., xviii. II. 649.
Pachyna Med. Bot., lxxxiv. II. 1089.
Pactus Mill. Dict., lili. II. 720. See *Cerasus*.
Pæonia L., xviii. I. 249; IV. 2535.
Pallurus L., xxxvii. II. 527; IV. 2547.
Pallura L., cit. III. 1295.
 Palmetto, IV. 2533. See *Chamaetropa*.
 Palm Sallow, III. 1563. See *Salix caprea*.
 Paper Birch, III. 1708. See *Betula papyracea*.
 Paper Mulberry, III. 1361. See *Broussonetia*.
Papyrus Encyc. Bot., cviii. III. 1361.
 Paraguay Tea, II. 529. See *Flex paraguayensis*.
 Parasol Acacia, II. 610. See *Robinia*.
 Park Leaves, I. 403. See *Tutsan*.
 Partridge Berry, II. 1125. See *Gaultheria*.
Passerina, cv. III. 1515. See *Daphne*.
Passiflora L., lxxxi. II. 964.
Passifloraceæ, lxxxi. II. 964.
 Passion Flower, II. 964.
Pavia Boerh., xxxii. I. 462, 469; IV. 2543.
 Pea Tree, *Scotch*, III. 590.
 Peach Tree, II. 679.
 Pear Tree, lxxvi. II. 880.
Pelargonium, I. 483.
Pentstemon Des., cxiv. IV. 2582.
 Peony, xviii. I. 243.
 Peppermint Tree, II. 959. See *Eucalyptus piperita*.
 Perfumed Cherry Tree, II. 707. See *Prunus Mahaleb*.
 Perado, II. 519. See *Flex*.
Periclymenum Ger., lxxix. II. 1048. See *Loniceria*.
Periploca L., xcix. III. 1257.
 Periwinkle, II. 1254.
 Pernettya Gaud., lxxxviii. II. 1078, 1124; IV. 2575.
 Perpetual Roses, II. 780, 783.
Persia Bpr., civ. III. 1305. See *Leonotis*, cit. III. 1283.
 Persian Lilac, II. 1211.
Périsia Tournef., I. II. 671, 679; IV. 2554.
 Persimon, II. 1195. See *Diospyros*.
 Peruvian Mastich, II. 950.
Pervincia Tournef., xcix. II. 1254.
 Petty Whin, II. 581.
Pêdagus Eucalvus Dalech., cxv. III. 1844.
Phaleroë Scop., lxxviii. II. 1078, 1127.
Phellodorus Matth., cxvii. III. 1859.
 Philadelphæceæ, lxx. II. 950.
 Philadelphia, lxx. II. 950; IV. 2567. See *Deutzia*.
Phillyrea Tournef., xcv. II. 1198, 1203.
Phlomis L., cli. III. 1279. See *Leonotus*, cit. III. 1283.
Phormium L., cxiv. IV. 2529.
 Photinia, lxxv. II. 968.
Physica L., xxix. II. 541. See *Soulangia*.
Phyllis L., lxxxi. II. 1082.
Phylloladus Rich., cxxxiii. IV. 2100.
Phyllodoce Sal., lxxxvii. II. 1077, 1115.
Physianthus Hort., cxiv. IV. 2581.
Physiculus Lour., not of L., lxxvii. II. 1027.
Picea D. Don, cxxxviii. IV. 2105, 2329.
Picea Lk., cxxxvii. IV. 2293.
Picea of the ancients, cxxxvii. IV. 2293.
Picea cxxxix. IV. 2329. See *Picea*.
Pientza W., lxxxi. II. 1075.
Pteris D. Don, lxxxvii. II. 1077, 1114.
Pimenta Lab., cv. III. 1515.
 Pimento royal, cxxxii. IV. 2056.
 Pin Oak, III. 1887. See *Quercus palustris*.
Pineaster, cxxxv. IV. 2213.
Pinebays, lxxxi. II. 1082.
 Pine Tree, cxxxvii. IV. 2152.
 Pine, Aleppo, IV. 2231.
 Pine, Geneva, IV. 2156.
 Pine, Highland, IV. 2154.
 Pine, Lobolly, IV. 2237.
 Pine, Mountain, or Krumhols, IV. 2186.
 Pine, Scotch, IV. 2153.
 Pine, Speyside, IV. 2154.
 Pine, Stone, IV. 2224.
 Pine, Table Mountain, IV. 2197.
 Pine, Weymouth, IV. 2280.
 Pine, Yellow, IV. 2195.
Pinus L., cxxxiii. IV. 2152.
 See *Abies*, cxxxvii. IV. 2293.
 See *Araucaria*, cxl. IV. 2432.
 See *Cedrus*, cxl. IV. 2402.
 See *Cunninghamsia*, IV. 2415.

See *Dammara*, IV. 2447.
 See *Larix*, cxxxix. IV. 2350.
 See *Picea*, cxxxviii. IV. 2329.
 Piperidge Bush, I. 299.
Piptanthus Surt., xli. II. 566.
Pistacia L., xxxix. II. 545; IV. 2548.
 Pitch Pine, IV. 2230.
Pittosporaceæ, cxvi. I. 356.
Pittosporum Banks., cxvii. I. 358.
Plagianthus Forst., cxvii. III. 1341.
Plagiobium Sm., xviii. I. 639.
Planera Gmel., cx. III. 1372, 1409.
 Plane Tree, cxxxix. IV. 2033.
 Plane Tree, Scotch, I. 414.
Platanaceæ, cxxxix. IV. 2032.
Platanus L., cxxxix. IV. 2033.
Platylobium Sm., xviii. II. 639.
Plectranthus L'Herit., cli. III. 1285.
Plocama All., lxxxi. II. 1064.
 Ploughman's Spikenard, II. 1065.
Plumbaginaceæ, cli. III. 1287.
Plumbago Thunb., cli. III. 1287.
 Plum Tree, II. 684.
Podalyria R. Br., xli. II. 567.
Podanthus Lindl., lxxxiii. II. 1072.
Podocarpus L'Herit., cxxxiii. IV. 2100.
Podolobium R. Br., xli. II. 567.
 Poet's Cassia, III. 1320.
Poinciana Dec., cxiv. IV. 2554.
 Poison Nut, II. 556.
 Poison Oak, II. 555.
 Poison Vine, II. 556.
 Poison-wood, II. 552.
Polyfolia Buxbaum, lxxxv. II. 1105.
Polygala L., xxvi. I. 356; IV. 2538.
Polygaleæ, xxvi. I. 355.
Polygonaceæ, cli. III. 1292.
Polygonum R. Br., cli. III. 1296.
Polygonum L., cli. III. 1292. See *Tragopyrum*. See *Ephedra*, IV. 2063.
 Poly, Mountain, II. 1106.
Pomaderris Labill., xxxix. I. 542.
 Pomegranate, II. 939.
 Pond Pine, IV. 2240.
 Poplar, III. 1636.
 Poplar, Athenian, III. 1651.
 Poplar, Black, III. 1652.
 Poplar, Black, in America, III. 1666.
 Poplar, Black Italian, III. 1657.
 Poplar, common Grey, III. 1639.
 Poplar, Old English, III. 1652.
 Poplar, Lombardy, III.
Populus Tournef., cxxx. III. 1454, 1636.
 Porcella *Pers.*, xx. 229.
 Portugal Broom, II. 589.
 Portugal Laurel, II. 714.
 Post Oak, III. 1870. See *Quercus obtusiloba*.
Potentilla L., lvi. II. 747; IV. 2357.
Pteridium L., cli. III. 1285.
Pterium L., lxx. II. 955.
Pseudanthus L., lxxxiii. II. 1072.
 Priesthood Dec., xlv. II. 649.
 Prickly Ash, I. 488. See *Xanthoxylum*.
 Prickly Broom, II. 571.
 Prickly Cedar, IV. 2494. See *Juniperus*.
 Prickly Pear, II. 967. See *Opuntia*.
 Prickwood, II. 1010. See *Eulonymus*.
 Pride of India, II. 945. See *Lagerstrœmia*.
Prinos L., xxxvi. II. 520; IV. 2546. See *Nemopanthes*, 523.
Prinus, III. 1872. See *Quercus Prinus*.
 Privet, II. 1198; III. 1872.
Prospira L., xli. II. 661.
Prostanthera Lab., cli. III. 1285.
Protodæceæ, civ. III. 1306.
Pruniphora Neck., j. II. 684.
Prunus Tournef., II. 671, 684; IV. 2554. See *Amygdalus*, *Armeniacæ*, and *Cerasus*.
Pseudocarya Moench, xlv. II. 609. See *Robinia*.
Pseudo-Capsicum Moench, c. III. 1266.
Pseudo-Cerasus, II. 701.
Pseudo-Cytisus, I. 312. See *Fœlia*.
Pseudolobus Matth., xcv. II. 1194.
Pseudo-Platanus, I. 414. See *Acer*.
Pseudo-Siber, III. 1917. See *Quercus*.
Pedium, lxxi. II. 961.
Psoralea L., xviii. II. 642.
Ptelea L., xxxiv. I. 487, 489; IV. 2544.
Pterocarpus Dec., xli. II. 661.
Pterocarya Kunth, cxl. III. 1421, 1451.
Pterocarya Pall., cli. III. 1295.
 Pultenaea, xli. II. 567.
Punica L., lxx. II. 939; IV. 2566.
 Purslane Tree. See *Atriplex*.

Purshia Dec., lili. II. 672. 721.
 Purple Beech, III. 1950.
 Purple Laburnum, II. 590.
 Purple-leaved Hazel, III. 2025. See *Corylus A. purpurea*, III. 2017.
Pyracantha II. 844.
Pyracantha of the Greeks, II. 829.
Pyraëter Ray, lxvi. II. 880. See *Pyrus*.
Pyræthrum W. En., lxxxiii. II. 1072.
Pyræta Schultz, Each., xxi. II. 1172.
Pyrus Lindl., lxvi. II. 673. 879.; IV. 2564. See *Crataegus*, *Photinia*, *Cotoneaster*, *Amelanchier*, and *Cydonia*.

Q.

Queen Mary's Thorn, II. 832.
 Queen's Needlework, II. 729.
 Quercitron, III. 1864. See *Quercus tinctoria*.
Quercus L., cxliv. III. 1715. 1717.
 Quince Tree, II. 929. See *Cydonia*.
 Quickset, II. 829.

R.

Rabbit Berry, III. 1327.
Rafals Thunb., xli. I. 640.
 Ragmal Oak, III. 1849.
Ranunculaceæ Dec., xvii. I. 231.
Raphiolepis Lindl., lxix. II. 932.
 Raspberry, II. 737. See *Rubus Fitis idææ*.
Reaumuriaceæ, IV. 2569.
Reaumuria, IV. 2569.
 Red Bay, III. 1299. See *Ladurus*.
 Red-blossomed Hawthorn, III. 832.
 Red Cedar, cxlii. IV. 2495. See *Juniperus virginiana*.
 Red Root, II. 539. See *Ceanothus*.
Requienia Dec., xvii. II. 641.
 Restharrow, II. 604. See *Ondnia*.
Rhus Brogn., xxxix. II. 541.
Rhamnaceæ Lindl., xxxvi. II. 1324.
Rhamnides Tourn., cvi. III. 1324.
Rhamnus Læm., xxxvii. II. 529.; IV. 2546. See *Zisypus*, *Falidurus*, *Cenoplia*, *Berchemia*, *Alaternus*, *Ceanothus*, *Planera*, *Sageretia* (*Theaeus*), *Scutia*, *Retanilla*, *Collètia*, and *Colubrina*.
Rhodociton Zacc., ci. III. 1277.
Rhododendron L., lxxxix. II. 1078. 1150.; IV. 2576.
Rhodora L., xc. II. 1145.; IV. 2576. See *Rhododendron*.
Rhus L., xxxix. II. 548.; IV. 2548. See *Ailantus*.
Ribes L., lxxii. II. 967.; IV. 2569.
Robinia L., xlv. II. 609.; IV. 2552. See *Caragana* and *Halmiodendron*.
 Roble de Duela, III. 1941.
Röber, III. 1731. See *Quercus*.
 Rock Rose, xxi. I. 317.
Rosaceæ Dec., xlix. II. 670.
Rosa Tourn., lvi. II. 672. 748.; IV. 2552. See *Löwea*.
 Rose Tree, II. 748.; IV. 2558.
 Rose à quatre Saisons, II. 759. 780. 806.
 Rose, Banksian, II. 812. See *Banksian*.
 Rose, Berberry-leaved, II. 777. See *Löwea*.
 Rose, Boursault, II. 775. 781.
 Rose, Briar, or Hedge, II. 766.
 Rose, Burgundy, II. 762.
 Rose, Cabbage, II. 760. 780.
 Rose Clare, II. 773.
 Rose de Meaux, II. 780. 762.
 Rose, Double yellow, II. 785.
 Rose, Ever-flowering China, II. 771.
 Rose, Frankfurt, II. 763.
 Rose, Lord Macartney's, II. 780. 783.
 Rose, Monthly, II. 770.
 Rose, Pomponne, II. 760.
 Rose, Provence, II. 760. 780.
 Rose, Seven Sisters, II. 774.
 Rose, Tea-scented, II. 770. 782.
 Rose, Yellow, II. 785.
 Rose, Yellow Austrian, II. 765.
 Rose Ardena, II. 627.
 Rose Bay, II. 1131.

Rose Laurel, II. 1132.
 Rose Willow, III. 1491.
 Rosemary, III. 1279.
 Roses, Ayrshire, II. 775. 781.
 Roses, China, II. 770. 781. 782.
 Roses, Climbing, II. 781. 779.
 Roses, Damask, II. 759. 761. See *Damask*.
 Roses, Evergreen, II. 775. 781.
 Roses, Isle de Bourbon, II. 783.
 Roses, Moss, II. 760. 780.
 Roses, Musk, II. 775. 783.
 Roses of Pestum, II. 784.
 Roses of Præneste, II. 784.
 Roses, Noisette, II. 770. 782.
 Roses, Scotch, II. 757. 783.
 Roses, White, II. 764. 781.
Rosmarinus L., cli. III. 1279.
 Rowan Tree, II. 916. See *Pyrus aucuparia*.
Rubia Ait., lxxxi. II. 1062.
Rubiaceæ, lxxxii. II. 161.; IV. 2573.
Rubus L., lvi. II. 672. 728.; IV. 2567. See *Keria*.
 Rue, xxxiv. I. 484. See *Aplophyllum*.
Rubus L., cli. III. 1296.
Ruscus L., cxliv. IV. 2516. 2517.
 Ruta L., xxxiv. I. 484.; IV. 2544.
Rutaceæ, xxxiv. I. 484.

S.

Saba Wall., xi. II. 560.
Sabina Bauh., cxlii. IV. 2487. See *Juniperus Sabina*.
 Saddle Tree, xix. I. 284.
Sagittis Brogn., xxxix. II. 541.
 Sage, See *Sálvia*, III. 1281.
Salicaceæ, cxl. III. 1483.
Salisburiæ Sm., cxxxiii. IV. 2065. 2084.
Sáliz L., cxl. III. 1483.
 Sallow, common Black, III. 1563.
 Sallow, Great round-leaved, III. 1559.
 Sallow Thorn, III. 1325.
Salsola L., clii. III. 1282.
 Salt Tree, II. 634. See *Halmiodendron*.
Sálvia L., cli. III. 1282.
Sambucus Tourn., lxxvii. II. 1027.; IV. 2572.
 Sand Myrtle, II. 1154. See *Lelophyllum*.
Santolina L., lxxxii. II. 1064. 1066.
Sapindaceæ, cxxxiii. I. 474.
Sapindus Lin. fil., cxxxiii. I. 475.
Sapotaceæ, xciv. II. 1191.
Sarcophyllum Thunb., xlv. II. 641.
 Sardia Nut, III. 1287. See *Juglans*.
Sarmentaceæ Nees Von Esenbeck, cxliv. IV. 2516.
 Sarsaparilla, cxliv. IV. 2511. See *Smilax*.
 Sasangua, I. 290. See *Camellia*.
Sassafras L., civ. III. 1301. See *Ladurus*.
 Sassafras Tree, III. 1301.
 Saxifrage, lxxv. II. 994.
Satureja L., cli. III. 1278.
 Saugh, III. 1563. See *Sáliz*.
 Savory, See *Satureja*, III. 1278.
 Savin, cxlii. IV. 2459. See *Juniperus*.
 Scaldberries, II. 748.
 Scaly Bark Hickory, III. 1446. See *Carya*.
 Scampston Elm, III. 1404.
 Scarlet Oak, III. 1879. See *Quercus coccinea*.
 Scarlet Thorn, II. 816.
 Scarlet Thyme, See *Cardoquiza*, III. 1261.
Schima L., li. II. 560. See *Davalia*.
Schisandra Michx., xx. I. 285.
Schisandraceæ, xx. I. 285.
 Schöbe Ait., xlix. II. 660.
 Schreber's Thun., xxxvi. II. 804.
Schubertia Mirb., cxlii. IV. 2480. See *Taxodium*.
Sclerothamnus A. Br., xli. I. 567.
Scorpius Monch Meth., xlii. I. 581.
 Scorpion Senna, II. 644. See *Coronilla*.
 Scotch Elm, III. 1359.
 Scotch Fir, cxxxiii. IV. 2153.
 Scotch Laburnum, II. 590. See *Cytisus alpinus*.
 Scotch Pine, cxxxiii. IV. 2153.
 Scott's A. Br., li. II. 640.
Scrophulariaceæ, ci. III. 1276.
 Scrub Oak, III. 1869. See *Quercus Catesbyi*.
Scutia Brogn., xxxix. II. 541.
 Sea Buckthorn, III. 1284. See *Hippophae*.

See Lavender. See *Státice*, III. 1287.
 Sea Purslane Tree, III. 1230.
 Sea Ragwort, II. 1071.
 Sédum, lxvii. II. 965.
 Sempervivum, lxvii. II. 965.
Senecio Alt., lxxvii. II. 1068.
Senecio Bot. Mag., lxxvii. II. 1072.
Sesuvium Comm., lxxv. II. 1082.
 Service, II. 921. See *Pyrus Sôrbus*.
 Shaddocks, I. 396.
 Shállon, II. 1126. See *Gaulthéria*.
 Shellbark Hickory, III. 1446.
 Shephérda Nut., cv. III. 1321. 1327.
 Shrubby Goosefoot, III. 1288.
 Shrubby Trefoll, I. 489. See *Ptêles*.
 Siberian Cedar, IV. 2375. See *Pinus Cembra*.
 Siberian Crab, II. 892.
 Siberian Lilac, II. 1312.
 Siberian Pea tree, II. 629.
 Sicilian Ragwort, II. 1071.
Sida (syn. *Abutilon*) Boiss., xxvi. 363.
Sida Alt., cl. II. 1288.
Siderôgrypa Lam., xcv. II. 1192. See *Argania*,
Bumêlla, and *Mýrsine*.
Siliquastrum Tourn., xlviii. II. 657. See *Cercis*.
Silene L., xvi. I. 369.
 Silk Tree, II. 665.
 Silver Fir, cxxxviii. IV. 2329. 2601. See *Picea*.
Slymbrium, xxi. I. 313.
 Slippery Elm, III. 1407.
 Sloe Thorn, II. 684. See *Pyrus spinôsa*.
 Smlax L., cxliii. IV. 2610.
 Smooth-fruited Horsechestnut, I. 468. See *Pavia*.
 Snake-bark Maple, I. 407. See *Acer striatum*.
 Snowball Tree, II. 1040. See *Viburnum*
Opulus.
 Snowberry Tree, II. 1062. See *Symphoricárpus*.
 Snowdrop Tree, II. 1189. See *Halésta*.
 Snowdrop Tree, Amer., II. 1206. See *Chionán-*
thus.
 Snow-flower, II. 1205. See *Chionánthus*.
 Snowy Mesplur, II. 874. See *Amelanchier*.
 Solanácees, c. III. 1266.
 Solánum, c. III. 1266.
Solandra L., cl. III. 1274.
Solantha O. Don, xxxix. II. 542.
Solya Lindl., xvi. I. 357.
Sónchus Jacq., lxxviii. II. 1072.
Sopâdra R. Br., xl. II. 563.; IV. 2649. See *Ed-*
wárdsia *Thermópala*, and *Virgilla*.
Sôrbus L., lxxviii. II. 921.; IV. 2566. See *Pyrus*.
Soulángia Brongn., xxxix. II. 542.
 Sour Gum Tree, III. 1317. See *Nýssa*.
 Southern Olive, cxlv. IV. 2679.
 Southern Wood, II. 1068. See *Artemisia*.
 South Sea Tree, II. 518. See *Cassine*.
 Sow Bread, II. 660. See *Ceratônia*.
 Spanish Broom, II. 576. See *Spártium fúnceum*.
 Spanish Chestnut, III. 1963.
 Spanish Furze, II. 591.
 Spanish Maple, IV. 2684.
 Spanish Oak, III. 1882. See *Quercus falcata*.
Spartíánthus Link, xli. I. 576. See *Staurac-*
ánthus.
Spártium, xli. II. 576.; IV. 2650. See *Genista*,
Cytisus, *Adenocárpus*, *Stauracánthus*.
Spermache Desf., lxxxi. II. 1082.
Sphæcele Benkt., cl. III. 1283.
Sphærocárpus Wall., xxxix. I. 541.
Sphæroblátum Swedh., xl. I. 567.
Sphærostêma, xx. I. 295.
Sphenotoma Swf., lxxviii. II. 1075.
Spiræa L., liii. II. 732.; IV. 2656. See *Kérria*
Spiræa *Christi*, II. 694. See *Zifryphus*.
 Spindle Tree, xxv. II. 496. See *Kuónymus*.
 Spotted-leaved Laurel, II. 1026. See *Aucuba*.
Spruce Bot. Cab., lxxvii. II. 1076.
 Spruce Fir, cxxxvii. IV. 2338. 2609. See *A'bies*
excelsa.
 Spurge Laurel, III. 1309. See *Dâphne* *póntica*.
 St. Dabeoc's Heath, III. 1116.
 St. John's Bread, II. 660.
 St. John's Wort, xxix. I. 397.
 St. Peter's Wort, II. 1058.
Stâchys *Biéd.*, cl. III. 1281.
Stâchys *Lessing*, lxxvii. II. 1063. 1064.
 Staff Tree, II. 502. See *Celâstrus*.
 Stag's Horn Laurel, II. 530. See *Rhús*.
Staphyléa L., xxxiv. I. 493.
Staphylacées, xxxiv. I. 493.
Staphylodéndron Tourn., xxxiv. II. 493.

Stâtes L., cl. III. 1287.
Stauracánthus, xli. II. 576.
Stemánthra A. Br., lxxviii. II. 1075.
Stercúlla L., xvi. I. 363.
Stemculicées, xliii. I. 353.
 Stillings Garden, cviii. III. 1330. 1332.
Stoc'hús Dod., lxxviii. II. 1070.
 Stonecrop, II. 965. See *Sédum*.
 Storax, II. 1187.
Stranvâ'sia Lindl., cxlv. IV. 2663.
 Strawberry Tree, II. 1117. See *A'rbutus*.
Strôbus, IV. 2380. See *Pinus*.
 Stringy Bark Tree, II. 959. See *Eucalyptus*.
Stuárta Cav. xxviii. I. 378. See *Malacodên-*
dron.
 Stump Tree, II. 656. See *Gymnócladus*.
Styloplástum Desf., xl. II. 560.
Syphêta R. Br., lxxviii. II. 1076.
Sýracées, xciv. II. 1187.
Sýrax L., xciv. II. 1187.
Sâber Cam., cxviii. III. 1911.
 Sugar Maple, I. 411.
 Sumach, II. 548. See *Rhús*.
 Sun Rose, xxii. I. 328.
Sutherlandia R. Br., xlvii. II. 645.
 Swamp Oak, Amer., IV. 2060. See *Casuarina*.
Swinabôta Sal., xlvii. II. 645.
 Sweet Bay Tree, III. 1297.
 Sweet Briar, II. 765.
 Sweet Chestnut, III. 1983.
 Sweet Gale, cxxxii. IV. 2036.
 Sweet Gum, See *Nýssa*.
 Sweet Locust, II. 650.
 Swiss Poplar, III. 1067.
 Sycamore, I. 414. See *A'cer*.
Sycamore, Amer., cxxxii. IV. 2043. See *Plâ-*
tanus.
Symphôria Pers., lxxxi. II. 1068.
Symphoricárpus Neck., lxxxi. II. 1058.
Symphoricárpus *Dill.*, lxxxi. II. 1027, 1058.
Symplocées, xciv. II. 1186.
Symplocos Ker., xciv. II. 1186.
Sýringa L., xcvi. II. 1198, 1208.
 Syringa of the Gardens, II. 951. See *Philadé-*
nius.
Sýringæa, xcvi. II. 1198, 1208.
Sýringedum Andr. Heath., lxxvii. II. 1089.

T.

Tacamahac Tree, III. 1673.
Tacônia, lxxxi. II. 965.
Tacôda, IV. 2327. See *Pinus*.
Tanaka, cxxxiii. IV. 2102.
Tamaricacées, lxx. II. 947.
Tâmarix Des., lxx. II. 947. See *Myricária*.
Tamarisk, II. 947.
Tasocétium L'Hérit., lxxviii. II. 1074.
Tarchonánthus Lam., lxxviii. II. 1072.
Tárton-raíra, cv. III. 1211. See *Dâphne*.
 Tartarian Honeysuckle, II. 1052.
 Tausin Oak, III. 1842.
Taverniâs Dec., xlviii. II. 646.
Taxacées, cxxxiii. IV. 2065.
Tâxus L., cxxxiii. IV. 2066, 2066.
 See *Podocárpus*, IV. 2100.
Taxodîum *Rich.*, cxliii. IV. 2480.
 Tea Tree, I. 392.
 Tea Tree of New Holland, II. 967.
 Tea Tree of Van Diemen's Land, cxlv. IV.
 2567.
Técouca, c. III. 1269.
Templétâs, xlvii. II. 640.
Tenôria Spreng., lxxv. II. 997. See *Eupledrûm*.
Terebinthacées, xxxiv. II. 548.
Terebinthus Juss., xxxix. II. 545. See *Pistâcia*.
Ternstrômiacées, xxvii. I. 376.
Tétralis, II. 1079. See *Erica*.
Tetrapâsma G. Don, xxxix. II. 642.
Teúcrium Schreb., cl. III. 1279.
Thalictria Spreng., cxxxii. IV. 2100. See *Dacrydium*.
Théa L., xxix. I. 381, 392.
 Thé de l'Abbé Gallois, III. 1377.
Thermópala, II. 566. See *Piptánthus* and *Ana-*
gýria.
Thibodâ H. B. et Kunth, xciv. II. 1175.
 Thorn Trees. See *Cratégus*, II. 813.
 Thorny Acacia, II. 650.
 Thûja, cxl. IV. 2106. 2454. See *Cuprésus* and
Cállitris.

- Thyme, III. 1278.
 Thymelacææ, civ. III. 1306.
Thymela a Tourn., civ. III. 1307. See *Daphne*.
Thymela a Gron., cv. III. 1314. See *Dica*.
Thymus L., cl. III. 1278. See *Acyos*.
Thysanthus Bliot., xlvii. II. 647.
Thyrea Parib., III. II. 741.
Tilia L., xxvii. I. 364.; IV. 2539.
Tillacææ Juss., xxvii. I. 364.
Tinus Tourn., lxxvii. II. 1032. See *Abúrnum*.
Tinus L., lxxvii. II. 1129. See *Clethra*.
Tithymalus Tourn., cvii. III. 1331.
 Tittmouse Walnut, III. 1423.
 Tobira, I. 358. See *Pittósporum*.
 Toothache Tree, xxxiv. I. 488. *Syn.* Prickly Ash,
Amer.
Toxicodéndron, II. 552. See *Rhús*.
Tózyton Rafinesque, cviii. III. 1362.
Tragopyrum Bieb., cli. III. 1292.
Trágos Cam., lxxxiii. IV. 2463.
 Traveller's Joy, xvii. I. 235.
 Tree Carnation, I. 359.
 Tree Currant, II. 980.
 Tree Flax, I. 360.
 Tree Heath, II. 1080.
 Tree Houseleek, II. 965.
 Tree Ivy, II. 1000.
 Tree Lupine, II. 649.
 Tree Mallow, I. 360.
 Tree Peony, xviii. I. 249.
 Tree Purslane, III. 1280.
 Tree Rhododendron, II. 1146.
 Tree Sorrel, III. 1296.
 Tree Strangler, II. 562.
 Tree Wormwood, II. 1069.
Trevis Meyer, xxxix. II. 541.
Triceros Lam., xl. II. 560.
Trichocarpus Neck., i. II. 679.
Trichocópalus Brognon., xxxix. II. 542.
Trilópus Mith., lxxv. II. 1007.
Tristania R. Br., lxxi. II. 956.
Trachocarpa R. Br., lxxxiii. II. 1075.
 True Service, II. 921. See *Pyrus* *Sórbus*.
 Trumpet Flower, III. 1288.
 Trumpet Honeysuckle, II. 1049.
 Tulip Tree, xix. I. 284.
 Turpentine Tree, II. 545. See *Pistácia*.
 Tupa G. Don, lxxx. II. 1063.
 Tupelo Tree, III. 1316.
 Turkey Oak, 1846, 1870.
 Tutsan, common, I. 403.
 Tutsan, Large-flowered, I. 400.
 Twin-flowered Spurge Laurel, III. 1310. See
Daphne *póntica*.
- U.
- Ulex* L., xli. II. 571.; IV. 2549. See *Staura-*
cánthus.
Ulmacææ, cviii. III. 1371.
Ulmus L., cviii. III. 1371. 1373. See *Plánera*.
Umbellacææ, lxxv. II. 997.
 Umbrella Tree, II. 269. See *Magnólia* *tripétala*.
 Upright Fly Honeysuckle, II. 1064. See *Xyló-*
teum.
Urtica Desv. xlvii. II. 645.
Urtica *græci* Spreng., lxxxviii. II. 1123. See *Vac-*
cinium.
Urticacææ, cvii. III. 1342.
- V.
- Vaccinium* L., xcii. II. 1079. 1156.
 See *Phalacrocarpus*, lxxxviii. II. 1127.
 See *Oxycoocus*, xciv. II. 1163.
 Valonia Oak, III. 1861.
 Vasee Dec., xlvii. II. 640.
 Veláni Tourn., cxxvi. III. 1862.
Vélla L., xxi. I. 312.
Verbena L'Herit., cli. III. 1286. See *Alofsia*.
Verbenacææ, cli. III. 1285.
 Venice Sumach, II. 549.
Vernonia Hook., lxxviii. II. 1072.
Véronica Ait., ci. III. 1277.
Vesicária, xxi. I. 313.
Vibérta Spreng., xlvii. II. 640.
Vibúrnum L., lxxvii. II. 1027. 1032.; IV. 2572.
Viórna, I. 238. See *Clematis*.
Vimbaria Smith, xli. II. 567.
Vinca L., xcix. II. 1254.
 Vine, I. 477. See *Vitis*.
 Vine Bower, See *Clematis* *Viticélla*, I. 241.
Virga, xcv. II. 1173.
Virga Matth., lxxvi. II. 1010.
Virgíla L., xli. II. 565.
 Virgin's Bower, xvii. I. 232.; IV. 2535.
 Virginian Creeper, a synonyme of *Ampelopsis*
Aederacææ, I. 482.
 Virginian Date Plum, II. 1196.
 Virginian Raspberry, II. 745.
 Virginian Sumach, II. 550.
Viscum L., lxxvii. II. 1021.
Vitacææ Lindl., xxxiii. I. 477.
Vitálba, I. 235.
Vitex L., cli. III. 1285.
Viticélla, I. 241.
Vitis L., xxxiii. I. 477.
Vitis *idaea* Tourn., xcii. II. 1156. See *Fac-*
cinium.
Vitis *idaea* *vábra* Lam., xcii. II. 1164.
Vulcanaria L., cli. III. 1286. See *Clerodéndron*.
Vulvaria *Edra* José Lam., xlvii. 641.
- W.
- Wahoo Elm, III. 1408.
 Wainscot Oak, III. 1846.
 Wallflower, I. 313. See *Cheiránthus*.
 Walnut Tree, III. 431. 1423. See *Júglans*.
 Warden Pear, II. 822.
 Warratah. See *Caméllia*, I. 286.
 Water Oak, III. 1832.
 Wax-bearing Myrtle, cxxxii. IV. 2057.
 Wax Tree, II. 1201.
 Water Elder, II. 1039.
 Wayfaring Tree, II. 1035.
 Weeping Ash, II. 1214.
 Weeping Beech, III. 1953.
 Weeping Birch, III. 1621.
 Weeping Elm. See *Ulmus* *montána* *péndula*,
 III. 1396.
 Weeping Oak, III. 1732. 1842.
 Weeping Turkey Oak, III. 1846.
 Weeping Willow, III. 1507.
Wicgela *Thunb.*, lxxix. II. 1042.
Wicgela *Pers.*, lxxix. II. 1042. See *Dierrilla*.
Wicandánda, xx. I. 297. See *Cócculus*.
 Western Plane, cxxxii. IV. 2043.
 Westringia Sm., cli. III. 1282.
 Weymouth Pine, IV. 2280.
 Whin, xli. II. 571.
 White Beam Tree, II. 910.
 White Birch, III. 1707. 1708.
 White Cedar, cxli. IV. 2475.
 White Spruce, IV. 2310. See *Abies* *álba*.
 White Thorn, II. 829.
 White Vine Clematis, xvii. I. 235.
 White Walnut, III. 1439.
 White Wood, xlx. I. 284.
 Whitty Pear Tree, II. 921.
 Whortleberry, II. 1156.
 Widow Wall. See *Cneórum*.
 Wild Allspice, III. 1303.
 Wild Cornel, II. 1010.
 Wild Gueider Rose, II. 1035.
 Wild Honeysuckle, II. 1140.
 Wild Indigo, II. 607.
 Wild Olive, II. 549. See *Rhús* *Cótinus*.
 Wild Olive, III. 1310. See *Daphne* *Thymela* *a*.
 Wild Olive, *Amer.*, III. 1319. See *Nyssa* *gran-*
dentata.
 Wild Olive Tree, III. 1321. See *Elaégmus*.
 Wild Orange, *Amer.*, II. 730. See *Cerasus* *car-*
oliniana.
 Wild Rosemary, II. 1106. See *Andrómeda*.
 Wild Service, II. 913.
Willemetis Brognon., xxxix. I. 542.
 Willow, III. 1453.
 Willow, Duke of Bedford's, III. 1517.
 Willow Oak, III. 1895.
 Wintercree R. Br., xvii. I. 266.
 Winter Berry, xxxvi. II. 520.
 Winter Flower, II. 967.

Wistaria Nutt., xviii. II. 647.; IV. 2563.
 Woodbine, II. 1043.
 Wormseed, II. 1068.
 Wych Elm, III. 1398.
 Wych Hazel, II. 1006.

X.

Xanthorhiza, xviii. I. 255.
 Xanthoxylaceæ, xxxiv. I. 487.
 Xanthoxylum L., xxxiv. I. 487, 488.
Xylisicum Juss., lxxx. II. 1050.
Xylisicum Dec., lxxx. II. 1050. See *Lonicera*.

Y.

Yellow Beech, III. 1963.
 Yellow China Rose, II. 771.
 Yellow Eglantine, II. 765.
 Yellow Root, xviii. I. 255.

Yellow Wood, II. 565. See *Virgilia*.
 Yellow Wood, III. 1362.
 Yew, American, cxxxiii. IV. 2093.
 Yew, common, cxxxiii. IV. 2066.
 Yew, Japan, IV. 2100. See *Podocarpus*.
Yucca L., cxliv. IV. 2521.
 Yulan Tree, xix. I. 278. See *Magnolia conspicua*.

Z.

Zanthoxylum, I. 487. See *Xanthoxylum*.
 Zeltkoua, III. 1469. See *Plánera*.
 Zenobia, lxxxvi. II. 1077, 1108.
 Zizyphus *Tourn.*, xxxvii. II. 524.; IV. 2547.
 See *Pallárus* and *Berchemia*.
Zómbia Pers., xlv. II. 646.
Zuccagnia Cav., xlix. II. 660.
 Zephyllaceæ, xxix. I. 484.
 Zephyllum, I. 484.

INDEX TO MISCELLANEOUS SUBJECTS.

A.

Aca'cia dealbata, mode of protecting, by Dr. Neill, I. 667.
 Acorns, eatable, III. 1845. 1906. 1913. 1919. *Teresa's* (see *Don Quixote*), III. 1907.
 Almonds as a stock for grafting, II. 678.
 Almonds, emulsion of, II. 676.
 Almonds, Bitter, II. 677.
 Almonds, Jordan, II. 677.
 Almonds, Valencia, II. 677.
 Aleppo mustard, II. 554.
 Amadou, III. 1644. 1834. False, III. 1833.
 Amboyna pitch, IV. 2448.
 American bug (*Aphis lanigera*), II. 903.
 Anisette de Bordeaux, I. 258.
 Arbutus, use of the fruit of, II. 1118.
 Arcades, trees fit for, I. 369.; IV. 2008.
 Arrack, anise, I. 258.
 Athenian poplar, origin of the name, III. 1651.
 Athol, Dukes of, their plantations, IV. 2359.
 Athol estates, culture of the larch on, IV. 2387.
 Avenues, trees for, I. 368. 418. 465.; III. 1379. 1642. 1666. 1670.; IV. 2041.

B.

Balm of Gilead, IV. 2340.
 Balsam of the Poplar, III. 1675.
 Barnacles, III. 1828.; IV. 2000.
 Baskets, I. 237.; III. 1447. 1471. 1697. 1709.
 Basket-making, III. 1471.
 Bast mats, mode of making, I. 367, 368, 369.
 Bachelor, derivation of the word, III. 1236.
 Beads, trees producing, I. 476. 484.
 Beating the walnut, use of, III. 1434.
 Beech, best wood for fuel, III. 1961.
 Beehives, II. 744.; IV. 2483.
 Bees, food for, I. 369.; II. 530.537. 577. 589. 719.; III. 1477. 1563.; IV. 2583.
 Besoms, to make, II. 596.; III. 1697. 2016.
 Bickers, II. 497.
 Bird cherry, as a trap for insects, I. 710.
 Birdlime, modes of making, II. 510. 1022.
 Bird's-eye maple wood, I. 412.
 Birds, paste for, I. 296.
 Black, to dye, I. 493.
 Blisters on the skin, to raise, I. 233.; III. 1308. 1330. 1368.
 Boundary oaks, III. 1779.
 Bowers, to cover, I. 233. 234.
 Bowers, trees for cutting into, I. 369.; II. 531.; III. 1203. 1374.; IV. 2010. 2493.
 Bows, wood used for, II. 591.; III. 1364. 2070. 2086.
 Box edgings, to cut, III. 1340.
 Box parterres of embroidery, III. 1337.; IV. 2585.
 Boxwood for wood-engraving and turnery, III. 1335.
 Bread from chestnut flour, III. 1967.
 Bread from the lotus, II. 526.

Brignole plums, mode of preserving, II. 689.
 Brooms, American, III. 2015.; IV. 2457. English, II. 595.; III. 1696. For butchers, IV. 2519.
 Bull oaks, III. 1779.
 Burgundy pitch, mode of preparing, IV. 2308.

C.

Caledonia, why so called, III. 2021.
 Camellia garden, I. 392.
 Camellia wall, I. 392.
 Camphor, mode of obtaining, III. 1305.
 Canada balsam, IV. 2340.
 Canella bark, I. 257.
 Canoes, wood for, I. 274. 288.; III. 1709.
 Cape heaths, list of, II. 1088. 1091. Mode of culture, IV. 2374. Treatment of, II. 1100.
 Capers, mode of preparing, I. 313, 314. Substitute for, II. 596.
 Caprification, III. 1370.
 Cardinal trees, III. 1383.
 Caries of the chestnut, III. 1969.
 Carvings in wood, I. 368.; III. 1415. 1642.
 Casks for sugar, III. 1879. 1881. 1883. For wine, III. 1991. Hoops for, IV. 1712.
 Casuarina (swamp oak), mode of growing in England, IV. 2061.
 Ceps, III. 1836.
 Charcoal of the beech, III. 1962.
 Charcoal, woods suitable for, I. 288. 368. 417. 424. 429.; II. 537. 1200.; III. 1368. 1525. 1563. 1647. 1681. 1962. 1991. 2009.
 Charmille, III. 2010.
 Cherry brandy, II. 697.
 Cherry trees in pots, II. 702.
 Cherry Sunday, II. 639.
 Chestnut bread, III. 1987. 1995. 1996.
 Chestnut charcoal, III. 1991.
 Chestnut timber, how distinguished from oak, III. 1989. 1991. 1992. 1993.
 China turpentine, II. 547.
 Chinese method of dwarfing trees, III. 1378.
 Chinese pickle, I. 280.
 Chocolate from the lime, I. 309.
 Church, ancient, of oak, III. 1748.
 Cider brandy, II. 896.
 Cider, to make, II. 897.
 Clap-boards, description of, IV. 2284.
 Clematine, I. 233.
 Cobbett's nursery, II. 616.
 Coffee, substitute for, II. 657.
 Colophony, IV. 2125. 2223. 2326.
 Columns of living trees, II. 1242.
 Confitures d'épine vinette, I. 301.
 Coquette, a machine for drying plants, III. 1960.
 Corf rods, III. 2023.
 Cork, mode of obtaining, III. 1914.
 Corn, effect of the berry on, I. 302.
 Coughs, remedies for, I. 264. 511.; IV. 2115.

Cranberries, mode of growing, ii. 1169, 1170.
 Crayons of charcoal, ii. 497.
 Cup-shaky timber, iii. 1992.
 Curious substances found in the oak, iii. 1783.
 Curled maple wood, i. 426.

D.

Dancing leaves, i. 558, 560.
 Dead Sea apple, iii. 1931.
 Deals, mode of cutting out of entire trees, iv. 2170.
 Death's head moth, ii. 1253.
 Deciduous cypress, knees of, iv. 2484.
 Dialling of wood, iii. 1999.
 Diving rod, iii. 2020.
 Dogwoods in America, iii. 1018.
 Dool trees, iv. 2542.
 Drifting sands, modes of planting in, ii. 582; iv. 2219.
 Drip of trees, shrubs that will thrive under, i. 403, 512; ii. 718; iii. 1001, 1309, 1339; iv. 2088.
 Dwarfs, Chinese, i. 279.
 Dye from walnuts, iii. 1429.
 Dye, yellow, from the quercitron, iii. 1886.
 Dying, trees and shrubs suitable for, i. 299, 302, 307, 427, 465, 493; ii. 530, 532, 537, 540, 549, 552, 564, 583, 687, 744; iii. 1261, 1313, 1364, 1429, 1458, 1525, 1681, 1886.

E.

Ebony, substitute for, iii. 1681.
 Edging, shrubs fit for, i. 355; iii. 1333.
 Elm, diseases and insects of, iii. 1385.
 Emperor moth, iv. 2032.
 Ericacetums and American grounds, ii. 1173, to 1186.
 Ericetums, or heatheries, ii. 1095, 1098.
 Ermine moth, ii. 906; iv. 2564.
 Eustache Dubois, knives of, iii. 1961.

F.

Fevers, remedies for, i. 268, 274, 288; ii. 543, 550, 1019; iii. 1525.
 Figs, as an article of commerce, iii. 1367. Mode of drying, iii. 1369.
 Figue-cagues, what made of, ii. 1197.
 Filberts, to keep, iii. 2027.
 Fir tree, why so called, iv. 2303.
 Flambeaux of the beech (tourteaux), iii. 1963.
 Flambeaux of the pine, iv. 2175.
 Flax, substitute for, ii. 577.
 Forest, New, first planting of. Mode of managing plantations in, iii. 1750, 1803.
 Forest of Dean, iii. 1750, 1805.
 Forest of the Black Mountain, iv. 2227.
 Forest of Orleans, iii. 1989.
 Forest of Tarnawa, in Scotland, ii. 509; iii. 1752.
 Forests of oak in Britain, iii. 1750.
 Forests of pines and fir, iv. 2113, 2165, 2220, 2300.
 Fox covers, ii. 571.
 Fragrant horsechestnut, i. 474.
 French berries, ii. 532.
 French plums, mode of preparing, ii. 689.
 Fungi figured. See the List of Fungi in the Table of Contents, cxxxii.
 Fungus, eatable, on the evergreen beech in Van Diemen's Land, iii. 1982.
 Furze, as fodder, mode of bruising, ii. 572. Dil- lenius's admiration of, ii. 572. Gigantic, ii. 571. See Hedges.

G.

Galette, la, to make, iii. 1996.
 Galls, American, iii. 1881.
 Gall nuts, iii. 1929.
 Galls on the oak, iii. 1823, 1843, 1929.
 Games and country sports relating to the apple, ii. 901.
 Goats, trees eaten by, ii. 477, 591; iii. 1513; iv. 2325.
 Goule sheaves, iv. 2067.
 Grafting clay, ii. 805.
 Grafting, herbaceous, i. 253.
 Granada, arms of the city of, ii. 940.

Gripping, custom of, ii. 901.
 Growth, rate of, of the larch, iv. 2392. Of the locust, ii. 612. Of the oak, iii. 1783. Of the poplar, iii. 1658. Of the silver fir, iv. 2332. Of the willow, iii. 1466, 1526.
 Gum Arabic, tree producing it, ii. 664.
 Gum benjamin, iii. 1303.
 Gum benzoin, iii. 1303.
 Gum of the cherry tree, ii. 698.
 Gum olibanum, iv. 2503.
 Gum sandarach, iv. 2463.
 Gum tragacanth, ii. 638.
 Gunpowder, charcoal used for making, i. 537; ii. 1011; iii. 1682, 2009, 2024.
 Gun-stocks, wood for, iii. 1427.

H.

Hair-streak butterfly, iii. 1869.
 Half-hardy plants, remarks on the treatment of, ii. 570, 667.
 Half-hardy heaths. See Cape heaths.
 Hardy heaths, lists of, ii. 1085, 1088, 1097.
 Hares and rabbits, trees eaten by, ii. 592.
 Hayforks, wood used for making in France, iii. 1415.
 Hazel rods, use of in ornamental buildings, iii. 2023.
 Heather in the open ground, ii. 1095.
 Hedges, shrubs and trees suitable for:—
 Achcia. See Locust.
 Alaternus, ii. 630.
 Althæa frutex, i. 362.
 Arbor Vitæ, iv. 2457.
 Berberry, i. 302.
 Beech, iii. 1965.
 Box, ii. 1340.
 Bramble, ii. 744.
 Buckthorn, ii. 532.
 Christ's Thorn, ii. 523.
 Crab, ii. 896.
 Elder, iii. 1029.
 Evergreen oak, iii. 1904.
 Furze, ii. 573. In Guernsey, iv. 2549. In the Isle of Man, iv. 2549.
 Gleditschia, ii. 651.
 Hawthorn, ii. 836.
 Hazel, iii. 2023.
 Holly, ii. 518. Mode of cutting, ii. 514.
 Hornbeam, iii. 2010.
 Ivy, iii. 1003.
 Juniper, iv. 2493.
 Larch, iv. 2373.
 Laurel, ii. 718.
 Laurustinus, iii. 1033.
 Lilac, iii. 1210.
 Locust, ii. 615, 625.
 Lombardy poplar, ii. 1663.
 Maple, i. 429.
 Mulberry, iii. 1355.
 Myrtle, ii. 963.
 Oak, iii. 1799.
 Pear tree, ii. 885.
 Privet, ii. 1900.
 Portugal laurel, ii. 715.
 Roses, ii. 772, 790.
 Sea buckthorn, ii. 1326.
 Sloe thorn, ii. 637.
 Spine 'a, ii. 737.
 Spruce fir, iv. 2306.
 Willow, iii. 1476.
 Yew, iv. 2089.
 Helianthemum wall, i. 349.
 Hemlock spruce, singular effect of in American woods, iv. 2323.
 High Clerc seedling rhododendrons, ii. 1140, 1143.
 Honey, poisonous, i. 369; ii. 1199. See Bees.
 Honeysuckle, a classical architectural ornament ii. 1043.
 Hoops, wood for, iii. 1441, 1467, 1697, 1711, 1712, 1994, 2023.
 Hop-poles, wood for, ii. 621; iii. 1219, 1460, 1553, 1996; iv. 2371.
 Hope, substitute for, ii. 596, 946.
 Hortensia, why this name was applied to the hydrangea, ii. 946.

House flies, effect of the periploca on, iii. 1257.
Huile de marmotte, ii. 684.
Huile de rose, ii. 789.
Hungary water, iii. 1280.

I.

Ice storm, iv. 2136.
Ilex oak, suitable for the sea shore, iii. 1902.
Indian paper, mode of making, iii. 1361.
Indian rubber, trees producing, iii. 1345. 1355.
Indian soup, iii. 1919.
Indigo, plant producing, ii. 642.
Indigo, substitutes for, ii. 607. 630.
Ink, indelible, ii. 555, 556. 686.
Ink, to make, iii. 1930.
Insects good for food, iii. 1816.
Insects on the *Abietinæ*, iv. 2139. : —
Alder, iii. 1687.
Birch, iii. 1703.
Oak, iii. 1815.
Fear tree, ii. 887.
Poplar, iii. 1638. 1654.
Rose, ii. 810.
Willow, iii. 1479.
Insects figured. See the list in the Table of Contents, clxxxiii.
Insects, use of bird cherry to protect from, ii. 710.
Irritability of plants, i. 300.; ii. 558.

J.

Japan varnish, ii. 553.
Judas tree, use of the flowers of, in cookery, ii. 658.
Jujube, syrup of, ii. 525.
Jujube trees, different kinds of, iv. 2546.
Juniper berries, uses of, iv. 2433.

K.

Kauri resin, iv. 2549.
Kermes, iii. 1909.
Kirschwasser, ii. 697.
Knee timber of the larch, iv. 2381.
Knee timber of the oak, iii. 1807.
Krumholz of Styria, iv. 2187.

L.

Labdanum, or ladanum, the mode of gathering, i. 390.
Labyrinths of the hornbeam, iii. 2011.
Lackey moth, iii. 1883.
Lamb's wool, the drink so called, ii. 901.
Lampblack, preparation of, iv. 2125. 2223.
Landes, mode of planting with pinasters, iv. 2219.
Landscape-gardening, effect of trees in, of the
Alder, iii. 1683.
Ash, ii. 1220.
Beech, iii. 1965.
Birch, iii. 1694. 1700.
Cedar of Lebanon, iv. 2418.
Elaeagnus, iii. 1323.
Elm, iii. 1333.
Hazel, thickets of, iii. 2025.
Hornbeam, iii. 2011.
Horsechestnut, i. 465.
Ivy, ii. 1004.
Larch, iv. 2377. 2373.
Lime tree, ii. 369.
Locust, ii. 621.
Lombardy poplar, iii. 1632.
Oak, iii. 1769.
Plane tree, iv. 2039.
Weeping willow, iii. 1709.
Willow, iii. 1527.
Scotch pine, iv. 2176.
Silver fir, iv. 2229.
Stone pine, iv. 2229.
Spruce fir, iv. 2301.
Sweet chestnut, iii. 1997.
Yew, iv. 2072.
Landscapes figured. See the list in Table of Contents, cxlv.
Larch, rate of growth of, iv. 2354.
Laurel water, ii. 719.
Lavender water, to make, iii. 1281.
Legends of the Abele, iii. 1643.
Alder, iii. 1683.

Legends of the Almond, ii. 678.

Apple, ii. 899.
Ash, ii. 1223.
Aspen, iii. 1648.
Black poplar, iii. 1654.
British oak, iii. 1753.
Chaste tree, iii. 1235.
Cornel tree, ii. 1016.
Christ's thorn, ii. 626.
Hawthorn, ii. 838.
Holly, ii. 511.
Ivy, ii. 1005.
Jasmine, ii. 1253.
Lime tree, iv. 2540.
Lombardy poplar, iii. 1632.
Mistletoe, ii. 1022.
Mountain ash, ii. 917 — 920.
Mulberry, iii. 1345.
Myrtle, ii. 961.
Oak, iii. 1722.
Periwinkle, ii. 1255.
Pine and fir tribe, iv. 21x1.
Plane tree, iv. 2037.
Pomegranate, ii. 940. 942.
Quince, ii. 929.
Rose, ii. 791.
Rosemary, iii. 1280.
Rue, i. 485.
St. John's wort, i. 297.
Sycamore, i. 418.; iv. 2542.
Sweet bay, iii. 1297.
Walnut, iii. 1426.
Willow, iii. 1463.
Yew, iv. 2066.
Licts de parlement, iii. 1991.
Lightning, effect of, on the oak, iii. 1812.
Limes, substitute for, iii. 1319.
Liqueurs, from fruit, i. 369.; ii. 681. 690. 697. 789.
Liquid storax, iv. 2051.
Liquorice, substitute for, ii. 621.
Locust tree, rapid growth of, ii. 612.
Luggies, ii. 497.
Lumbering party in Canada, iv. 2116.
Lungs of the oak, iii. 1832.
Lye for washing linen, ii. 574.

M.

Magnolia of Maillardière, i. 263.
Magnolia wall, i. 264.
Manna of Briançon, iv. 2367.
Manna, trees producing, i. 410.; ii. 616. 1246.
Manx furze, iv. 2549.
Maraschino, ii. 697.
Mastich, ii. 548. 560. Substitute for, iv. 2605.
Meat, to tender, iii. 1368.
Medical uses of the resinous products of the pine and fir tribe, iv. 2126.
Milky sap, plants possessing, i. 409.; ii. 553.; iii. 1330. 1345. 1355. 1368.
Mistletoe, germination of, ii. 1024. Mode of propagating, iv. 2571. On the oak, iii. 1831.
Morels, iii. 1974.
Mosque of Cordova, wood of, iv. 2463.
Moths, to keep away, iv. 2057.
Mount Magnolia, described by Bartram, i. 276.
Mulberry, edict of James I. respecting, iii. 1346.
Mode of gathering the leaves for silkworms, iii. 1355.

N.

Noces, why so called, iii. 1426.
Noggins, ii. 497.
Norfolk beauties, to prepare, ii. 896.
Nougat, iii. 1428.
Nurse trees, iii. 1800. : —
Larch, iv. 2372.
Scotch pine, iii. 1803.
Spruce fir, iv. 2305.
Nut, maggot of, iii. 2027.
Nut oil, iii. 2024.
Nut, weevil of, iii. 2027.
Nuts, kinds of, iii. 2019. Quantity imported, iii. 2024.

O.

Oil, beech, ii. 1963.
 Oil from the privet, ii. 1900.
 Oil made from the cone of *Pinus Cembra*, iv. 2979.
 Oil, nut, iii. 2094.
 Oil of rosemary, iii. 1920.
 Oil of sweet almonds, ii. 676.
 Oil of turpentine, iv. 2336.
 Oil of walnuts, iii. 1429.
 Oil, olive, to make, ii. 1207.
 Olives, substitute for, ii. 686.
 Olives, to pickle, ii. 1207.
 Onguent de St. Fiacre. See Grafting clay, ii. 805.

P.

Pannage, iii. 1747.
 Paper birch, uses of, iii. 1709.
 Paraguay tea, mode of making, ii. 520.
 Parfait amour, ii. 789.
 Parterres of embroidery in box, iii. 1337.; iv. 2585.
 Peach brandy, ii. 681.
 Pears, mode of obtaining new kinds, by Dr. Van Mons, ii. 892.
 Pears, French, mode of preserving, ii. 883.
 Pears, to dry, ii. 883.
 Perry, to make, ii. 884. 897.
 Pines and firs, cuttings of, iv. 2128.
 Pines and firs, grafting, iv. 2129.
 Pine barrens, iv. 2117.
 Pine forest on fire, iv. 2157.
 Pinetums, iv. 2120.
 Pinetums of Great Britain, tabular view of, iv. 2450.
 Pitch, iv. 2125. 2175. 2222. 2260.
 Pitch, black, iv. 2222.
 Pitch, Burgundy, iv. 2308.
 Plane tree, shade of, iv. 2047.
 Plane tree, wool of, iv. 2045.
 Planting from pots, i. 265.
 Planting in puddle, i. 371.
 Planting, by fixing with water, i. 265.
 Poetry on the Arbutus, ii. 1117.
 Beech, iii. 1958.
 Birch, iii. 1700.
 Furze, ii. 574.
 Hazel, iii. 2021.
 Holly, ii. 512.
 Ling, ii. 1084.
 Oak, iii. 1785.
 Walnut, iii. 1431.
 Wayfaring tree, ii. 1035.
 Yew, iv. 2083.
 Poisoning plants, i. 300.
 Poisonous trees and shrubs, i. 233. 476. 493.; ii. 549. 553. 555. 561. 564. 610. 709. 719.; iii. 1267. 1308.
 Polenta, to make, iii. 1996.
 Pomatum, origin of, ii. 896.
 Portable house, for protecting plants, ii. 670.
 Port wine from British fruit, ii. 686.
 Potash, trees producing, i. 412.; ii. 572. 583. 596. 1219.; iii. 1480. 1525. 1647.
 Pounce, what made of, iv. 2403.
 Protecting by gauze or bunting, i. 280. With mats, i. 257. By straw ropes, i. 279.
 Protecting frame for plants, iv. 2531.
 Protecting trees and shrubs, i. 290. 364. 392. 396.; iii. wall, 1306.
 Protecting roots, i. 266.
 Prunes, mode of preparing, ii. 689.
 Prussic acid, plants producing, ii. 671. 714.
 Public walks, trees suitable for, i. 368. 416. 418.; iii. 1:84. 1415. 1643.
 Pumping of the larch, iv. 2385.
 Purple, to dye, i. 427.
 Pyrale, iii. 1939.
 Pyrolignous acid, iv. 2399.
 Pyrotechnic clock, 258.

Q.

Quass, mode of making, iv. 235

R.

Reidné, to make, ii. 896. 818.
 Raki, the liqueur so called, ii. 690.
 Ranging timbers in America, iv. 2118.
 Ratafia of Grenoble, ii. 697.
 Red oak staves, iii. 1836.
 Red, to dye, i. 530.
 Religious ceremonies, trees used in, ii. 501. 518.; iv. 2349.
 Remarkable trees:—
 Alders, iii. 1687.
 Apple trees, ii. 908.
 Arbutus, in the Bot. Gard. Edin., iv. 2575.
 Ash trees, ii. 1225.; iv. 2580.
 Balsam poplars, iii. 1675.
 Beeches, iii. 1954. 1970. 1976.
 Black walnut, iii. 1438.
 Buyukdère plane tree, iv. 2042.
 Cedars, iv. 2404. 2425. 2500. Of Mount Lebanon, iv. 2407. 2411. Visits of travellers to, iv. 2409.
 Chestnuts, remarkable iii. 1967. 1998. Of Mount Elza, iii. 1967.
 Cypresses, remarkable, iv. 2466. 2470.
 Deciduous cypresses, large trees of, iv. 2483.
 Elms, iii. 1391. 1402.
 Fig trees, iii. 1367.
 Hawthorns, ii. 840.; iv. 2562.
 Hollies, ii. 515.
 Hornbeams, iii. 2007. 2012.
 Horse chestnuts, i. 466.
 Johnson's willow, iii. 1518.
 Larches, iv. 2355.
 Laurels, ii. 719.
 Lime trees, i. 371.; iv. 2538.
 Lombardy poplars, iii. 1670.
 Mulberry trees, iii. 1345. 1347. At Canterbury, iv. 2586.
 Myrtles, ii. 963.
 Napoleon's willow, iii. 1511.
 Oaks, iii. 1741. 1753. 1773. 1837. With conjoined trunks, iii. 1781.
 Pear trees, ii. 681. 698.
 Pines in the Canaries, iv. 2263.
 Plane trees, iv. 2038. 2042.
 Poplars, iii. 1654.
 Portugal laurel, ii. 715.; iv. 2555.
 Salisburias, iv. 2009.
 Scotch pines, iv. 2184.
 Silver firs, iv. 2337.
 Spruce firs at the Whim, iv. 22.
 Stone pine of Sabettes, iv. 2228.
 Sycamores, i. 419.; iv. 2542.
 Walnut trees, iii. 1435.
 Willows, iii. 1308. 1518. 1527.
 Yews, iv. 2069. 2073. 2091.
 Zelkova, iii. 1411.
 Resin. See Rosin.
 Resinous products of the pine and fir tribes, iv. 2125. 2174. 2221.
 Rheumatism, cures for, i. 268. 489.; iii. 1267.
 Rhododendron, honey of, ii. 1132.
 Rock work, plants for, i. 313. 336. 348. 393. 409. 402.; ii. 578. 583. 601. 604. 638. 800. 966.; iii. 1968. 1277. 1278. 1287. 1309. 1313.
 Rosariums, ii. 794.; iv. 2561.
 Rose Acacia, mode of training, ii. 698.
 Rose, architectural, ii. 793.
 Rose garden, ii. 793.
 Rose, history of, ii. 785.
 Rose, insects on, to destroy, ii. 809.
 Rose of Lancaster, ii. 761.
 Rose, mode of drying the petals, ii. 787. 788.
 Rose pink, ii. 681.
 Rose plantations, ii. 786. 787. 788.
 Rose-water, ii. 788. 790.
 Rose wall, ii. 800.
 Roses, arcades of, ii. 797.
 Roses, attar of, ii. 780.
 Roses, baskets of, ii. 800.
 Roses, best collections, ii. 750.
 Roses, budding the, ii. 802.
 Roses, climbing, ii. 799.
 Roses, conserve of, ii. 789.
 Roses, essence of, ii. 788.

Roses, hedges of, ii. 790.
 Roses, honey of, ii. 789.
 Roses, oil of, ii. 789.
 Roses, parasol rods for training, ii. 799.
 Roses, pruning, ii. 807.
 Roses, replanting, ii. 806.
 Roses, spirit of, ii. 789.
 Roses, standard, ii. 807, 808.
 Roses, sweetmeat of, ii. 790.
 Roses, training, ii. 799, 809.
 Roses, undergrowth of, ii. 790.
 Roses, vinegar of, ii. 788.
 Rosette, why so called, ii. 793.
 Rosin, Kauri, iv. 2549.
 Rosin, mode of preparing, iv. 2125, 2331.
 Rosin of *A'bies Douglasii*, iv. 2390.
 Rosin, yellow, iv. 2522.
 Rue, uses of, i. 485.

S

Sabots, to make, iii. 1961.
 Sacred trees, i. 15.
 Ailantus, i. 460.
 Deodar Cedar, iv. 2429.
 Mexican fir, iv. 2349.
 Oaks, Chaonian, iii. 1723; among the Celts, iii. 1722; as land marks, iii. 1780; evergreen, iii. 1901.
 Pine, iv. 2535.
 Salicine, iii. 1439.
 Salicium, iii. 1437.
 Salt, pipes for, iii. 1381.
 Sandal-wood, iii. 1413.
 Sap green, mode of making, ii. 532.
 Sassafras root, i. 252.
 Savernake Forest, iii. 1792.
 Scarlet leaves, plants producing them in autumn, i. 405, 418, 427; ii. 549, 553; iv. 2051.
 Scenting linen, i. 258.
 Scolytus destructor, iii. 1387.
 Sea coast, trees suitable for, i. 418.
 Sea shore, trees fit for, iii. 1903.
 Seeds tenacious of life, i. 299.
 Senna, leaves used for, i. 492.
 Plant producing, ii. 660.
 Substitute for, ii. 636.
 Shaky wood, iii. 1999, 2009.
 Sherbet, to make, i. 376.
 Shingles, description of, iv. 2324.
 Ship-building, history of, iii. 1742.
 Shoemaker's wax, composition of, iv. 2127.
 Silkworms, to feed, iii. 1350, 1366, 1364, 1368.
 Silver fir, vitality of the stumps of, iv. 2107, 2333.
 Sirope de Groselle, ii. 978.
 Skewers, ii. 497.
 Slide of Alpmach, iv. 2115.
 Sloughing, shrubs which will produce, i. 233.
 Spanish fly, ii. 1201, 1224.
 Spirituos liquors from trees, i. 258, 294, 298; ii. 525, 543, 558, 560, 621, 690, 697, 710, 743, 782, 804, 806, 1119, 1196; iii. 1346.
 Sports of All Hallow' E'en, ii. 901.
 Spruce beer, mode of making, iv. 2315.
 Stakes of oak found in the Thames, iii. 1742.
 Stocks for magnolias, i. 283.
 For peaches, ii. 678.
 For plums, ii. 690.
 For roses, ii. 783.
 Storax, mode of gathering, ii. 1188.
 Strasburg turpentine, mode of preparing, iv. 2335.
 Sycamore, germination of, i. 415.
 Sycophant, origin of, iii. 1366.
 Sugar from the cones of Pinus Lambertiana, iv. 2291.
 Sugar from the fuchsia, iv. 2567.
 Sugar, mode of preparing from the maple, i. 413.
 Sugar trees and shrubs from which it is made, i. 329, 410, 413, 417, 494, 429; ii. 652, 1133; iv. 2291, 2567.

T

Tables of citron wood of the Romans, iv. 2473.
Tamarinds, substitute for, ii. 627.
Tanning, bark fit for, i. 302, 465, 492; ii. 549, 553, 596, 687, 1085, 1123, 1219; iii. 1459, 1647, 1653, 1681, 1725, 1789, 1879, 1883, 1886, 1889, 1902, 1991; iv. 2194, 2236, 2365, 2373.

Tanning in America, iii. 1879, 1883, 1886, 1889.
Tar, best from the Scotch pine, iv. 2174. Mode of preparing, iv. 2125, 2174, 2259.
Tees, substitutes for, ii. 686; iii. 1577, 1391; iv. 2557.
Tempot handles, ii. 510.
Tendering meat, iii. 1368.
Thickets of brambles, use of in landscape-gardening, ii. 745.
Thyrus of Bacchus, iv. 2112.
Timber in single oak, iii. 1777.
Tobacco, substitute for, ii. 554.
Topiary-work, i. 429; ii. 530, 727, 873; iii. 1900, 1333, 1339, 1340; iv. 2013, 2072, 2454, 2467.
Toys, wood for, i. 368, 417.
Transplanting large trees, i. 570.
Trees and shrubs considered botanically, i. 211.
Trees and shrubs considered pictorially, i. 193.
Trees and shrubs considered with reference to man, i. 219.
Trees and shrubs, economical history of, i. 222.
Trees and shrubs, history and geography of, i. 15.
Trees and shrubs indigenous to Britain, i. 20.
Trees and shrubs introduced by the Romans, i. 32.
Trees and shrubs introduced in modern times, i. 35.
Trees and shrubs known to the ancients, i. 15.
Trees and shrubs, literature of, i. 187.
Trees and shrubs, study of, i. 192.
Trees and shrubs of Asia, Africa, America, and Australia, i. 172.
Trees and shrubs of the Continent of Europe, i. 132.
Trees of the Egyptians, i. 15.
Trees having the heart and sap wood alike, ii. 875.
Trenails, ii. 614.
Truffles, iii. 1974.
Tunbridge ware, iii. 1335.
Turkish cemetery, iv. 2469.
Turpentine, ii. 547; iv. 2125, 2335, 2259, 2367.
Turpentine, Chian, ii. 547.
Turpentine, Cyprus, ii. 547.
Turpentine, mode of collecting in America, iv. 2259.
Turpentine, Strasburg, iv. 2335.
Turpentine, Venice, iv. 2267.

U

Unguentum populeum, how composed, iii. 1654.

V

Valonia, use of in dying, iii. 1822.
Varnish, Japan, ii. 553.
Varnish, mastich, ii. 548.
Veranda, to cover, i. 233, 234, 237.
Venice turpentine, mode of obtaining, iv. 2367.
 Substitute for, iv. 2294.
Vinegar, ii. 560.
Vines trained on elms, iii. 1381, 1382.

W

Wall, conservative, i. 280, 284, 392, 396.
Wall for camellias, i. 392.
Wall for helianthemums, i. 349.
Wall for magnolias, i. 264.
Wall for oranges and lemons, i. 396.
Wall for roses, ii. 800.
Walnut timber, to prepare, iii. 1427.
Walnut, to graft, iii. 1432.
Wasall bowl, ii. 901.
Wax from the candleberry myrtle, iv. 2068.
Whips, mode of making, iii. 1827.
White balsam of Peru, iv. 2051.
Wild pigeons, iii. 1829.
Willows, fences of, iii. 1476.
Willows for baskets, iii. 1468.
Willows for hoops, iii. 1467.
Willows, peeling of, iii. 1470.
Willows, plantations of, iii. 1456.
Willows, rapid growth of, iii. 1526.
Wine-casks, iii. 1881, 1883, 1991.
Wistman's wood, iii. 1767, 1786, 1837, 1839.
Witches and Demons, shrub supposed to drive away, i. 397.

- Witch's butter, iii. 1835.
 Wood-engraving, iii. 1335.
 Wood never worm-eaten, iii. 1411.
 Wood, ornamental, l. 412. 426. 441. 460. 490.; ii. 566. 596. 639. 698. 703. 708. 709. 1319. 1321.; iii. 1364. 1380. 1400. 1415. 1419. 1427.; iv. 2040. 2046. 2051. 2085.
 Woodpecker, ii. 700. Why called, in America, carpenters, iii. 1896.
 Woods, natural succession of, iv. 2135.
 Wych, derivation of, iii. 1381.
- Y.
- Yellow juice, l. 255.; ii. 551. 553.
 Yellow leaves in autumn, l. 405. 418. 475.; ii. 566.; iii. 2024.
- Yellow morocco, mode of tanning and dying, ii. 533.
 Yellow rose, history of, ii. 757.
 Yellow soap, composition of, iv. 2127.
 Yellow, to dye, l. 929. 302. 307. 465.; ii. 532. 537. 564. 583. 596. 621. 637. 1085.; iii. 1364. 1437. 1386. 2009.
 Yews in churchyards, iv. 2070.
 Yew, largest, iv. 2069.
 Yew, poisonous nature of, iv. 2083.
 Yoke tree of the ancients, iv. 2007.
 Yucca starch, iv. 2221.
- Z.
- Zwetschen wasser, ii. 600.

INDEX TO PERSONS AND PLACES.

The names here collected are exclusive of the botanical authorities given with the scientific names, and also, for the most part, of the names of authors, the titles of whose books are given in connexion with their names. The names in this index are collected from the general text, and chiefly from the historical part, p. 1 to 230, and from the statistica. We had, with immense labour, noted down every page where the same name occurred; but, after having completed the index in MS. in this way, we found the number of pages after many of the names so great, that, had we printed them, the index would have extended to nearly double its present length, without being proportionately useful. We resolved, therefore, to confine ourselves to a reference to one page after each name, and that page the one where the name first occurred. To give some idea of the length to which this index would have extended, had we introduced references to all the pages, we may mention that the Flitwick Arboretum is referred to in fifty different places; the Goldworth Arboretum, in nearly sixty places; the Hackney Arboretum, under that name, in above seventy places; and under the name of Messrs. Loddiges's collection, in upwards of 150 places; the Horticultural Society's Garden at Chiswick in 470 places; and so on. We have, in some cases, marked after the name the number of places where it occurs.

A.

- AAROW, p. 9408.
 Abbé Berlioz, 9470.
 Abbey of Pompliers, 1979.
 Abbott, 1868.
 Abbott and Smith, 1893.
 Abbotbury Castle, 664.
 Abbot's Wood, 1750.
 Abel, Dr., 391.
 Abercorn Priory, 2234.
 Abercrombie, Mr., 80.
 Aberdeen, 105.
 Aberdeen, Earl of, 2120.
 Aberdour, 1402.
 Aberfeldie, 769.
 Abernethy, 2166.
 Abernethy Pine Forest, 2165.
 Aberpergwm, 1840.
 Abraham, 1780.
 Abresche, M., 2532.
 Absalom, 1750.
 Academus, 2038.
 Acaulico, 1948.
 Achilles, 247.
 Ackworth, 1841.
 Acland, Sir T. D., 1854.
 Adam, 1382.
 Adam, Sir Fred., 2328.
 Adam, Wm., 2306.
 Adanson, 263.
 Adanson, Madame Agéé, 132.
 Adare, 1257.
 Addison, 54.
 A. De C., 164.
 Adnam, Mr., 1429.
 Adonia, 791. 1853.
 Adian, 2037.
 Adria, 962.
 Adria Sylvius, 1830.
 Agamemnon, 2039.
 Agardi, Dr., 184.
 Agricola, 82.
 Agricultural Academy, Stockholm, 155.
 Agrippa, Empress, 1957.
 Aicholts, 717.
 Aigie, 1351.
 Ailsa, Marquess of, 2542.
 Ainslie, 2396.
 Ainslie, Mr., 2395.
 Airlie Castle, 430.
 Airthrey Castle, 419.
 Aiton, W. T., 75.
 Aix, 1287.
 Ajax, 1643.
 Albany, 1152.
 Albert Durer, 1332.
 Alberti, Leon, 2467.
 Albertini and Schweinitz, 2149.
 Abcester, 1393.
 Achimon, 963.
 Ackborough, 948.
 Acliff Hall, 419.
 Aidenham Abbey, 2310.
 Aidsworth Churchyard, 2091.
 Aleppo, 1180.
 Alexander, 1351.
 Alexander, Emperor, 121.
 Alexander the Great, 2408.
 Alexandria, 1213.
 Alford, 651.
 Alfred, 1768.
 Algiers, 587.
 Allentown, 1883.
 Albeley, 1482.
 Albeley Rectory, 1511.
 Allioni, 247.
 Allonville, 1773.
 Allos, 2303.
 Allos House, 1655.
 Alnwick Castle, 2551.
 Alpmach, slide of, 2115.
 Alpuka, 159.
 Alresford, 419.
 Alsace, 627.
 Alten, 1694.
 Alton Towers, 228.
 Aiva, 1797.
 Amadan, 792.
 Ambleside, 1957.
 Ambleton, 769.
 Amesbury, 592.
 Amherst, 2003.
 Amherst, Earl, 248.
 Amherst, Lady, 2535.
 Amiens, 1379.
 Amissa, 697.
 Amman, Dr., 81.
 Ammonoy, 140.
 Amoureux, M., 589.
 Amphiarus, 1891.
 Amphicoccus, 689.
 Amphill Park, 491.
 Ampson Hall, 667.
 Amroth Castle, 397.
 Amsterdam, 142.
 Ancreon, 791.
 Ancus Martins, 1748.
 Anderida, 1749.
 Andernach, 2114.
 Anderson, A., 1075.
 Anderson, Dr., 188.
 Anderson, Mr., 1928.
 Anderson, G., 250. 1533. 1538.
 Anderson, W., 74.
 Anderson, W., H. N., 2075.
 Andorre, Valley of, 1367.
 Andover, 1751.
 Andrews, James, 2027.

Andrews, John, 2067.
 Andrews, C. J., 2067.
 Andromeda, 1105.
 Androvandus, 187.
 Aneurin, 1749.
 Angers, 1843.
 Angota, M., 2285.
 Anjou, 1116.
 Ankerwyke, 2076.
 Anna Boleyn, 2076.
 Annaberg, 2539.
 Annat Garden, 2351.
 Anthony, 791.
 Antibes, 2234.
 Antioch, 1120.
 Antoninus, 478.
 Antrando, 1892.
 Antrim Castle, 109.
 Antuco, 2436.
 Antwerp, 144.
 Apalachicola, 2536.
 Ap Gwyllm, David, 2079.
 Apollo, 791.
 Apollo, Temple of, at Utica, 2406.
 Apuleius, 1023.
 Aragon, 587.
 Arambaro, 1949.
 Arbelá, 1639.
 Arbigland, 91, 101.
 Arboretums, or considerable col-
 lections:—
 Alton Towers, 129.
 Arundel Castle, 129.
 Austin's, Glasgow, 132.
 Backhouse's, York, 131.
 Bagshot Park, 129.
 Barton Hall, 129.
 Belsay Castle, 129.
 Berlin Botanic Garden, 151.
 Bieton, 129.
 Biebrich Grand-Ducal Botanic
 Garden, 152.
 Birmingham Bot. Gard., 130.
 Bishop Stoke Vicarage, 129.
 Blenheim, 127.
 Boynton, 129.
 Brown's, Perth, 132.
 Bruck on the Leytha, 150.
 Buchanan's, Camberwell, 131.
 Buchanan and Oldroyd's, 304.
 Caledonian Hort. Soc., 130.
 Camberwell, 850.
 Carclew, 129.
 Carlsruhe, 152.
 Charleville Forest, 129.
 Chatsworth, 129.
 Cheshunt, 129.
 Chiswick, 208.
 Cobham Hall, 129.
 Colchester Botanic Garden, 130.
 Cunningham's, Liverpool, 131.
 Dalhousie Castle, 129.
 Deepdene, 129.
 De Magnèveille's, M., 139.
 Dessau, 153.
 Dickson's, Chester, 131.
 Dickson's, Edinburgh, 132.
 Donald's, Goldworth, 131.
 Donaueschingen, 152.
 Dornbach, 150.
 Dresden Botanic Garden, 151.
 Dropmore, 129.
 Drumlanrig, 129.
 Dumont de Courset's, M., 139.
 Dunrobin, 129.
 Eisenstadt, 150.
 Endleigh Cottage, 129.
 Flitwick House, 129. (and in fifty
 other places).
 Fonthill Abbey, 128.
 Foreign Institute, Stockholm,
 155.
 Glasgow Botanic Garden, 130.
 Glasnevin, 132.
 Goldworth, 308. (and in 53 other
 places).
 Gordon Castle, 129.

Arboretums—*continued.*
 Göttingen, 151.
 Hackney, 508. (and in 66 other
 places).
 Hadersdorf, 130.
 Hafton, 129.
 Harbke, 151.
 Heidelberg Castle, 151.
 Held's Nursery, 150.
 Herrenhausen, 151.
 High Clere, 129.
 Harrison's, W., Cheshunt, 1528.
 Hull Botanic Garden, 130.
 Hylands, 129.
 Inverleith, 130.
 Ivroy's, M., near Bordeaux, 139.
 Jardine Hall, 129.
 Josephine's, Empress, Malmaison,
 139.
 Kew, 7. (and in thirty other
 places).
 King of the French's, Neuilly,
 139.
 Knight's, Mr., King's Road,
 Chelsea, 131.
 Laffert's, Baron, 153.
 Lanarrais's, General, 139.
 Larminat's, M. De, Forest of
 Fontainebleau, 140.
 Latham House, 129.
 Lawson's, Edinburgh, 131.
 Lee's, Hammersmith, 131.
 Liverpool Botanic Garden, 130.
 Loddiges's, Hackney, 6. (and in
 155 other places).
 London Horticultural Society's,
 Chiswick, 6.
 Luscombe, 129.
 Luxembourg, 150.
 Mamhead, 129.
 Manchester Botanic Garden, 130.
 Mere Cottage, 129.
 Metz Botanic Garden, 140.
 Milford, 427.
 Millers's Bristol Nursery, 131.
 Montron's, M. le Comte de, 139.
 Montpellier Botanic Garden, 140.
 Munich Botanic Garden, 151.
 Muskau, 151.
 Newman's, Chichester, 131.
 Northumberland's, Duke of, 7.
 Nymphenburg, 151.
 Oakham Park, 129.
 Osborne's, Fulham, 131.
 Page's, Southampton, 131.
 Pappenheim's, Baron, Coombe
 la Ville, 139.
 Paris Botanic Garden, 140. :
 Pesth Botanic Garden, 150.
 Fauen Insel, 151.
 Pope's, Birmingham, 131.
 Purser's Cross, 208.
 Rogers's, Southampton, 131.
 Rosenberg, Royal Gardens of, 154.
 Rosenstein Palace, 152.
 Rosenthal's Nursery, 150.
 Sans Souci, 151.
 Schönhoff, 150.
 Sheffield Botanic Garden, 130.
 Skirving's, Liverpool, 131.
 Somerford Hall, 129.
 Soulange-Bodin's, M., Fromont
 on the Seine, 139.
 St. Mary's Isle, 129.
 Strasburg Botanic Garden, 140.
 Syon, 7; and in many other places.
 Tschitgoff's, Admiral, Scéaux,
 139.
 Tereure, 129.
 Toepflitz, 150.
 Toulon Botanic Garden, 140.
 Trinity College Botanic Garden,
 130.
 Tschoudi's, M. le Baron, Colum-
 bière, 139.
 Upton, 208.
 Vienna Univers. Bot. Gard., 150.

Arboretums—*continued.*
 Villmorin's, M., Barres, 139.
 Wardour Castle, 129.
 Webb's, P. B., 131.
 Weber's, Lieut., Dresden, 151.
 West Dean, 129.
 White Knights, 127.
 Wilhelmshoe, at Cassel, 152.
 Woburn Abbey, 129.
 Wodzieki's, Count, at Niezda-
 vics, near Cracow, 815.
 Wörlitz, 153.
 Young's, Epsom, 131.
 Young and Penny's, Milford,
 131.
 Archangel, 2352.
 Archdall, Ralph, 1778.
 Ardgowan, 570.
 Ardkinglass, 89.
 Ardross, 2185.
 Argenteuil, 1369.
 Argostoll, 2387.
 Argyle, Archibald Duke of, 54.
 Argyll, Geo. Wm. Campbell, Duke
 of, 92.
 Argyll, Marquess of, 92.
 Ario, 1942.
 Aristotle, 187.
 Aristomachus, 689.
 Arley, 259.
 Arley Hall, 253.
 Armisau, 2111.
 Armiston, 1967.
 Armstrong, 93.
 Arnold's Vale, 1686.
 Arnot, 86.
 Arran, 1084.
 Arthur, Prince, 1747.
 Artemis, 1068.
 Arundel, 1629.
 Arundel and Surrey, Thos. Earl
 of, 717.
 Arundel Castle, 1299.
 Arundel, Countess of, 717.
 Arundel, Lord, 24.
 Ascalon, 1203.
 Ascham, Roger, 2070.
 Ashburnham Place, 997.
 Ashby Canons, 1777.
 Ashby Churchyard, 2092.
 Ashby, George, 2413.
 Ashby, Wm., 2413.
 Ashby, William Ashby, 2413.
 Ashhurst, Sir W., 461.
 Ashley Park, 71.
 Ashmole, Mr., 53.
 Ashridge Park, 358.
 Ashstead, 371.
 Ashton, 1837.
 Ashton Molly, 1519.
 Astrachan, 893.
 Ashworth, Mr., 1400.
 Atalanta, 930.
 Athenæus, 951.
 Athens, 2038.
 Athol, 2334.
 Athol, Duke of, 1217.
 Athol, John Duke of, 2359.
 Athol House, 2397.
 Atkins, Sir Robert, 1989.
 Atkinson, Mr., 1738.
 Attar, 792.
 Atterbury, Bishop of, 2406.
 Atya, 2122.
 Aubrey, 25.
 Auchincruive, 2001.
 Audibert, M., 2228.
 Audley End, 655.
 Audouin, M., 1369.
 Augerius, Baron de Burbeck, 147.
 Augsburg, 1210.
 Augustine, 2071.
 Augustus, 225.
 Aurelian, 1351.
 Aurora, 791.
 Austin, Mr., 757.
 Austria, Emperor of, 148.

Avicenna, 788, 1661, 2429.
 Aviemore, 1115.
 Avignon, 1370.
 Avitus, 1780.
 Avondale Park, 2295.
 Azara, Joseph Nicholas, 544.

B.

Baal, Bel, or Yiaoul, 1752.
 Babbington, Mr., 1118.
 Babbicome, 350.
 Babylon, 1005.
 Babylon, Gardens of, 2420.
 Bacchus, 791.
 Bacheller, 464.
 Back, Captain, 194.
 Backhouse, James, 186.
 Backhouse, Thomas, 186.
 Backleton Churchyard, 2022.
 Bacon, Lord, 941.
 Bacon, Mr. Stephen, 81.
 Baden, 147.
 Baden, Grand Duke of, 147.
 Baden, William Margrave of, 147.
 Badmington, 1440.
 Bagatelle, 2257.
 Bagdad, 661.
 Baginton, 1779.
 Bagot, Lord, 1789.
 Bagot's Mill, 1402.
 Bagot's Park, 1769.
 Bagot, Sir Walter, 1402.
 Bagshot Park, 410. (and 59 other references).
 Baikal, 949.
 Bailie, George, 102.
 Bain, Dr., 2234.
 Baitford, 1977.
 Bajazet II., 172.
 Baker, W. A., 2120.
 Balbis, 2555.
 Balcarras, 2067.
 Balder, Apollo, 48, 1022.
 Baleine, 138.
 Balfour, Dr., 45.
 Ballabagh, 940.
 Balie, Robt., 1902.
 Ballindalock, 2120.
 Ballinacastle, 91.
 Ballinlogie, 1704.
 Ballybeg, 2184.
 Ballygammon, 515.
 Ballykeady, 427. (and 16 other references).
 Ballyroddy, 1033.
 Baltimore, 283.
 Bampton, 831.
 Banata, 2805.
 Banbury, 2072.
 Banbury, Henry, 882.
 Bancroft, Dr., 1887.
 Bangor, 112.
 Bangor, Viscount, 112.
 Banister, 239.
 Banister, Rev. John, 44.
 Banks, Sir Joseph, 82. (and 94 other references).
 Bannockburn Wood, 700.
 Banquet, 2210.
 Barendam, 695.
 Barbeuld, Mrs., 1118.
 Barbé, 2157.
 Barclay, Robt. 342, 343, 1029.
 Bargany, 91.
 Barganny, 980.
 Baril, 1975.
 Barjarg, 1772.
 Barjarg, Lord, 1772.
 Barker, D., 1770.
 Barking Churchyard, 1759.
 Barlow, 618.
 Barne, 372.
 Barne Elms, 1225.
 Barnes, 616.
 Barnes, Mr., 833.
 Barnes, 841.

Barnton Hall, 1841.
 Barnton House, 1394.
 Bawn, 1403.
 Baron, Lord, 107.
 Baron's Court, 593.
 Baron, Mr., 304.
 Barratt, Dr., 1457.
 Barrelier, 2415.
 Barres, 139. (and 18 other places).
 Barrie, 1522.
 Barrière de Chaillot, 518.
 Barrington, Daines, 23.
 Barrington, Lady, 1783.
 Barrow, Mr., 2431.
 Barry Cornwall, 1643.
 Barton, 238.
 Bartram, John, 82.
 Bartram, W., 84.
 Barwood Park, 2224.
 Basil, 2538.
 Basileigh, 2184.
 Bdale, 161, 697.
 Basset, Lady, 2216.
 Bastard, E. P., 326.
 Bastia, 265.
 Bataille de Mandelot, M., 2452.
 Bateman, Richard, 81.
 Bates, Ralph, 1783.
 Bateson, Sir Robert, 49.
 Bath, 71.
 Bath, Marquess of, Plantations, 2168.
 Bathsheba, 1463.
 Bathurst, 964.
 Batsfield, 2359.
 Battersea, 1347.
 Baucis, 2084.
 Baudrillart, 461.
 Baubin, 236.
 Baubin, C., 505.
 Baubin, J., 890.
 Baumann, M., 366.
 Baumgarten, Dr., 1210.
 Bavaria, 1017.
 Baxter, W., 119.
 Baxter, W. H., 1481.
 Bayforbury, 2130.
 Bayle, 1721.
 Bayonne, 1731.
 Bayswater, 792.
 Beaconsfield, 1839.
 Beaconsfield, Churchyard at, 2081.
 Beardstone, 825.
 Bear Wood, 419.
 Beaton, Mr. D., 943.
 Beatrice, 1044.
 Beaton, General, 1511.
 Beauchamp Parsonage, 657.
 Beaudevert Park, 1769.
 Beaufort, Duchess of, 1440.
 Beaufort, Duchess of, 51.
 Beaulieu Abbey, 1383.
 Beaulieu, 1221.
 Beaumont and Fletcher, 1958.
 Beauvais, 2285.
 Beaverdam, 1365.
 Bechstein, 2143.
 Beckford, Mrs., 63.
 Beckford, William, 128.
 Beckmann, 147.
 Beckington, 962.
 Bede, 478.
 Bedford, 1832.
 Bedford, America, 2194.
 Bedford, Duke of, 56. (and 20 other references).
 Bedford, John Duke of, 2183.
 Bedington, 325.
 Beech Woods, 1037.
 Beechworth Castle, 2007.
 Beerheba, 1790, 2461.
 Beeston, Dr., 62.
 Bejar, 1062.
 Bèze, Abbé, 169.
 Belkist, 516.
 Belgium, 1670.
 Bell, John, 83.

Bellione, 2000.
 Bellonius, 2425.
 Belmont, 1957.
 Belon, 187.
 Beisay, 2120.
 Beivoir Castle, 419.
 Beivoir Park, 115.
 Bénarque, 2188.
 Benefield, 1793.
 Ben Jonson, 1722.
 Ben Lawers, 1157.
 Ben-na-Build, 2164.
 Bennet, Mr., 82.
 Bennett, George, 2101.
 Bennett, the Hon. Henry Grey, 1542.
 Bentham, G., 1019.
 Bentick, Mr., 41.
 Benvie, 1257.
 Bézarde, M., 2452.
 Berg, 2380.
 Bergius, 1225.
 Berkeley, Dr., 2126.
 Berkeley, Mrs., 1970.
 Berkeley, Rev. M. J., 1836.
 Berkeley Street, 1284.
 Berkswell, 1855.
 Bérèse, Abbé, 2100.
 Berlin, 151.
 Berlandier, 972.
 Bernard de Jussieu, 137.
 Bernard, M., 1539.
 Berne, 161.
 Bern Wood, 1756.
 Berthema, Ludovico, 757.
 Bertrand, M., 1511.
 Berytes, 1851.
 Beschiral, 2412.
 Bessa, 189.
 Besser, 674.
 Betchworth Castle, 2000.
 Beukelson, 1467.
 Bewdly Forest, 2140.
 Bewick, Benjamin, 83.
 Bicton, 222.
 Bielefeld, 1746.
 Bieberstein, 235.
 Biebrich, 152.
 Biel, 329.
 Bielvet, 1467.
 Bigelow, Professor, 479.
 Biggin, G., 1520.
 Biggs, Mr., 823.
 Biggs, Abbé, 1258. . .
 Billington, 1869.
 Binfield Wood, 1754.
 Binning Wood, 102.
 Bins, 1225.
 Birch Wood, 1703.
 Birkland, or Bireland, 1782.
 Birmingham, 139.
 Birse, 2580.
 Bishop Auckland, 1082.
 Bishop, Mr., 2201.
 Bishop, Thomas, 2120.
 Bishop Stoke Viarage, 265.
 Bishopton, 419.
 Biskerry, 2411.
 Blackadder, W., 2355.
 Blackburn, John, 2189.
 Blackburne, Mr., 56.
 Blackdown House, 1070.
 Black Forest, 152.
 Blackhall, 369.
 Blackmoor, 1758.
 Black Mountain, 2314.
 Black Notley, 83.
 Blackwall, 1041.
 Blackwood, Miss, 2063.
 Blackie, Mr., 128.
 Blair, 419. (and 18 other references).
 Blair, Adam, 2323.
 Blair Drummond, 94.
 Blair, T., 2401.
 Blair, Sir David Hunter, 2462.
 Blairlogie, 430, 2125.
 Blairquhan, 2242.
 Blake, Mr., 241.

- Blakie, Mr., 469.
 Blandford, 1758.
 Blandford, Marquess, Duke of Marlborough, 2512.
 Blenheim Park, 70.
 Blithfield, 1365.
 Blockley, 1778.
 Blomfield, Bishop, 43.
 Blume, 1173.
 Blythefield, 909.
 Bobart, Jacob, 51.
 Bobbe, M., 9452.
 Bochart, 299.
 Bode, 2000.
 Bodnome, Master Roger, 895.
 Boerhaave, 485.
 Boethius, 1085.
 Bognor, 1523.
 Bohm, 677.
 Bolleau, M. P., 2188.
 Bois de Boulogne, 612.
 Bois de Vincennes, 1390.
 Bois le Duc, 2089.
 Boissel de Monville, M., 2364.
 Botpoo, 919.
 Bologna, 187.
 Bolton, 371.
 Bolton and Watt, Messrs., 2395.
 Bolton, Lady, 1848.
 Bolton, Lord, 1837.
 Bolton, Matthew, 1394.
 Bollwyler, 140.
 Bonafous, M., 1364.
 Bonami, 963.
 Bondaroy, 1897.
 Bon de Saint Hilaire, M., 147.
 Bongard, 2329.
 Bonhill House, 1226.
 Bonifacio, 585.
 Bonnevaux, 1774.
 Bonpland, Aimé, 121.
 Bonpland, 272.
 Bontemps, Colonel Augustus, 162.
 Boodurwar, 940.
 Booth, Messrs., 409.
 Boreas, 2121.
 Bornholz, 1975.
 Borrer, W., 753. (and 52 other references).
 Borria, 1979.
 Borria House, 1841.
 Borron, Arthur, 1458.
 Bory de St. Vincent, 1370.
 Boec, 314. (and 75 other references).
 Boesobel, 1768.
 Boesière, 163. 593.
 Boston, 190.
 Botley, 612.
 Bothwell Castle, 515.
 Bothwell Woods, 2519.
 Botley, 612.
 Boucher, 1223.
 Boughton, Sir Theodosius, 719.
 Boulogne, 139.
 Bourdeaux, 614.
 Bourdigny, 163.
 Bourne, 511.
 Bourne, Frederick, 815.
 Bourmault, M., 266.
 Boucher, 105.
 Bouton, M. L., 2546.
 Bove, N., 2405.
 Bowack, 47. 57.
 Bowie, Mr., 661.
 Bowman, J. E., 2070.
 Bowman, W., 1760.
 Bowring, Dr., 618.
 Bowood, 71.
 Box Hill, 94. 25. 2091.
 Boxley, 45.
 Boxwell, 25.
 Boynton House, 843.
 Boyton, 1462.
 Brabant, 2089.
 Braburne Churchyard, 2091.
 Bracconet, 1834.
 Brackenridge, Mr., 1831.
 Braco Castle, 2313.
 Braddick, Mr., 883.
 Bradley, 54.
 Brae-Riach, 1598.
 Braemar, 1646.
 Braham Castle, 466.
 Brampton Park, 1203.
 Brand, 900.
 Bray, 1033.
 Braybrooke, 2092.
 Braystock, 430.
 Brebison, 2146.
 Brechin Castle, 93.
 Bree, Rev. W. T., 1223.
 Breima Forest, 2305.
 Bremen, 153.
 Bremonnier, 2124.
 Bremonnier, M., 2219.
 Brent Downs, 350.
 Brereton, Colonel, 1906.
 Brest, 618.
 Bretesche, M. le Comte de la, 138.
 Bretton Hall, 1103.
 Brentford, 1514.
 Brewer, Mr., 55.
 Brianza, 169.
 Brickhill, 1625.
 Bridehead House, 419.
 Bridges, Mr., 306.
 Bridgewater, Countess of, 1977.
 Bridgman, 2072.
 Bridport, 766.
 Brighton, 948. 1367.
 Brindley, 2162.
 Brinefield, 1840.
 Brisbane Town, 2445.
 Bristol, 192. 1404.
 British Palace, 666.
 Britton, 128.
 Brochill, 1917.
 Brockedon, Mr., 2356.
 Brockett Hall, 2185.
 Brockley Hall, 371.
 Bromley, 390.
 Bromley, W., 959.
 Brompton, 394.
 Bronde, Count Trolle, 155.
 Brongliart, 2111.
 Brooks, Joseph, 82.
 Brooks, J. T., 406.
 Brotero, 1414.
 Broughton House, 1295.
 Brousonet, 302.
 Brown, 36.
 Brown, Dr., 1896.
 Brown, D. J., 190.
 Brown, Robert, 256.
 Brown, Mr. Hay, 1394.
 Brown, Mr., Old Brompton, 2396.
 Brown, Mr., Perth, 757.
 Brown, Sir Matthew, 25.
 Browne, Mr. Hetherset, 1523.
 Brownsville, 425.
 Bruce, 2079.
 Bruce, Sir William, 92. 103.
 Brucefield, 716.
 Brück on the Leytha, 150. (and 169 other references).
 Bruen, Colonel, 1841.
 Bruggen, 152.
 Bruggmans, 738.
 Brunels, M., 2205.
 Brunn, 628.
 Brunner, Mr., 1987.
 Brunoy, 139.
 Brunswick, America, 2240.
 Brussels, 145.
 Bruyer, Cornelius, 2410.
 Brydone, 1968.
 Buccleugh, Duchess, 1782.
 Buccleugh and Queensberry, Duke of, 92.
 Buchanan, 245.
 Buchanan and Oldroyd, 757.
 Buchanan, Dr., Hamilton, 1921.
 Buckeridge House, 2530.
 Buckingham, 785.
 Buckingham, Duke of, 40.
 Buckingham Palace, 1547.
 Buckland Churchyard, Dover, 2074.
 Buckland Hill, 1839.
 Buddle, Adam, 1276.
 Buffon, 135.
 Bugby, 421.
 Buiset, R., 1364.
 Bull, Mr., 1458.
 Bulter, Anthony, 1020.
 Bulliard, 1975.
 Bullock, Mr., 333.
 Bulstrode, 1761.
 Bunbury, Lady, 2328.
 Bunbury, Sir Henry, 2326.
 Bungay, 476.
 Bunge, 2095.
 Bunney, 119.
 Bunyart, Messrs., 622.
 Burchell, Mr., 297.
 Burckhardt, 1242.
 Burgess, 1777.
 Burgos, 1927.
 Burgsdorf, 2125.
 Burgundy, Duke of, 162.
 Buriagh, Lord, 39.
 Burlington, America, 2241.
 Burnmeister, Dr. H., 1828.
 Burnet, Professor, 257.
 Burns, 1086.
 Bursa, 674.
 Burton, 2073.
 Burton, Robert, Esq., 1768.
 Burtonjoyce, 908.
 Bury Hill, 342.
 Bury St. Edmunds, 1527.
 Busbequius, 1210.
 Busbridge, near Godalming, Surrey, 73. 491.
 Busch, Mr., 633.
 Bush, John, 82.
 Busby Park, 465.
 Bussaco, 2478.
 Bute, Earl of, 2042.
 Bute, James Earl of, 181.
 Bute, John Earl of, 83.
 Bute, Marchioness of, 2030.
 Butcher, W., 188.
 Burykère, or the Great Valley, 172.
 Byron, 941.
 Byron, Admiral, 2060.
 Byron, Commodore, 1982.
 Bystock Park, 878.

C.

- Cacus, 1643.
 Cadix, 1925. 2210.
 Caen, 139.
 Caerleon, 2078.
 Caernarvon, Earl of, 73.
 Cæsar, 21.
 Cæsar, Julius, 169.
 Cæsar, Sir Julius, 1748.
 Cairn Sallock, 89.
 Calthness, 1157.
 Calais, 1390.
 Caldeuch, 2321.
 Calder House, 419.
 Calicut, 757.
 Calligula, 2039.
 Calligula, Emperor, 2334.
 Callendar House, near Falkirk, 89.
 Callendar Park, 419.
 Callimachus, 1725.
 Callow, Mr., 833.
 Cally, 920.
 Camberwell, 151.
 Cambrensis, Giraldus, 23.
 Cambridge, 1382.
 Camden House, 941.
 Camden, 35.
 Camden House, 314.
 Camellus, or Kamel, Geo. Jos., 381.
 Camerarius, Joachim, 1717.

- Cameron, 2184.
 Campbell, Colin, 91.
 Campbell, John, Marquess of Breadalbane, 91.
 Campbell, Lord Frederick, 2332.
 Campbell, Miss, 2067.
 Campbell, Mr., 1073.
 Campbell, Sir Duncan, 2080.
 Campbell, Sir John, 91.
 Campbell, W. F., 389.
 Campo, 2209.
 Campsey Ash, 1917.
 Camuset, M., 1361.
 Canaan, 1275.
 Canada, 522.
 Canby, Mr. Edward, 1775.
 Cane Wood, 913.
 Canham, Mrs., 75.
 Cannon Hall, 414.
 Cannon Park, 417.
 Canterbury, 622.
 Canton, 177.
 Cape Fear, 1237.
 Cape Horn, 153.
 Cape Town, 1272.
 Captainhead, 1458.
 Capush, 1217.
 Caractacus, 1721.
 Carberry, Lord, 114.
 Carclew, 269.
 Cardigan, Earl of, 1782.
 Cardinal Wolsey, 1768.
 Carduus, 2057.
 Carclew, 1824.
 Carew, Sir Francis, 962.
 Carhampton, Earl of, 2184.
 Cartisle, 192.
 Carlsruhe, 147.
 Carlton Hall, 1731.
 Carmichael, 91.
 Carnarvon, Lord, 119.
 Carnoch, 1225.
 Carolina, 553.
 Carr, Colonel, 955.
 Carrick, Earl of, 1841.
 Carrick on Suir, 2185.
 Carrington, 1757.
 Carrol, Mr., 111.
 Caryata, 1441.
 Carse of Gowrie, 881.
 Carthage, 2170.
 Carthagen, 1427.
 Carton, 1393.
 Cary, 1441.
 Cascellus, 2112.
 Case, P. J., 622.
 Caserta, 163.
 Cashibury, 59.
 Cashmere, 950.
 Casoretti, Signor, 2536.
 Casandra, 1108.
 Casel, 162.
 Casilla, 419.
 Casilla, Countess of, 2542.
 Casilla, John Earl of, 2542.
 Casincarrie, 290.
 Cassiope, 1107.
 Castanea, 1983.
 Castel, 465.
 Castelet, 1350.
 Castiglione, Count Louis, 169.
 Castle of Alsenau, 1774.
 Castle Ashby, 1764.
 Castle Cooke, 878.
 Castle Freke, 114.
 Castle Grant, Plantations at, 2166.
 Castle Head, 9001.
 Castle of Fernherst, 1773.
 Castle of Hiedelberg, 1017.
 Castle Hill, 1854.
 Castle Howard, 1394.
 Castle Huntley, 840.
 Castle Inn, Slough, 1264.
 Castle Lead, 863.
 Castle of Lochwood, 1772.
 Castle Mainard, 1119.
 Castle Sand, 8001.
 Castletown, 114.
 Castle Ward, 112, 113.
 Castle of Winchester, 1747.
 Castle Wood, 2092.
 Castle, Mr., 58.
 Castles, R., 75.
 Castles, George, 1514.
 Catesby, Mark, 69.
 Catherine, Empress, 79.
 Cativules, 2039.
 Cato, 187.
 Catron, Father, 785.
 Catros, M., 472.
 Catullus, 1430.
 Caubul, 940.
 Cawdor Castle, 2562.
 Caulen Penryn, 466.
 Caus, Solomon, 147.
 Cavanilles, 312.
 Caversham Park, 422.
 Cecil, Sir Thomas, 3.
 Cedar House, 59.
 Cedar Island, 2496.
 Cels, M., 139.
 Cephalus, 1105.
 Cepheus, 1107.
 Ceres, 941.
 Cerra de Oyamel, 1167.
 Cerro de las Nahajas, 1943.
 Cessford Castle, 1226.
 Cestoni, M., 1910.
 Chaillot, 137.
 Chalfont House, 1644.
 Chalna, 1948.
 Chamber of the Forest, 1756.
 Chambers, Sir William, 80.
 Chambersburg, 2194.
 Chandler, 242.
 Chandler, Dr., 511.
 Chandler, Mr., 386.
 Chandler and Booth, Messrs., 382.
 Chandler and Son, Messrs., 383.
 Chantilly, 1977.
 Chaon, 1723.
 Chaonian Forest, 1723.
 Chaptal, 1999.
 Chardin, Sir John, 786, 2039.
 Charlemagne, 32.
 Charles I., 23.
 Charles II., 61.
 Charles V., 1467.
 Charles VIII., 1331.
 Charles VIII., 1352.
 Charles IX., 1352.
 Charles the Bold, 2538.
 Charles the Rash, 162.
 Charleston, 936.
 Charlestown, 70.
 Charleville, Earl of, 113.
 Charleville Forest, 113.
 Charley Wood, 2426.
 Charlotte, Her Majesty, the late Queen, 121.
 Charlton, 1391.
 Charlton House, 624.
 Chartreux, 2471.
 Charlwood, Mr., 269.
 Chase Park, 1840.
 Château de Maskirch, 1017.
 Château de Montigny, 2414.
 Château de Neuville, 1665.
 Chatham, 1750.
 Chât Meraut, 2186.
 Chatsworth, 363.
 Chauce, 786.
 Cheam, 619.
 Chesapeake, 2041.
 Cheke, Master, 2086.
 Chelmsford, 2358.
 Chelsea, 62.
 Chelsea College, 464.
 Cheltenham, 1393.
 Chepstow Castle, 1746.
 Chertsey, 712.
 Chester, 131.
 Cheshunt, 414.
 Chevening, 1838.
 Chevrenil, Professor, 2417.
 Chichester, 131.
 Child, W. L., 735.
 Child's, Sir Josiah, 45.
 Chippanco, 1944.
 Chios, 1956.
 Chipping Camden, 2001.
 Chipping Cawdor, 1978.
 Chipstead Place, 2130.
 Chiron, 1203.
 Chiswick, 123.
 Chiswick (D. of Devonshire's), 73.
 Cholmeley, Francis, 128.
 Cholmondeley, 684.
 Choir Mountain, 1921.
 Chailot, 157.
 Christ Church, Cambridge, 1347.
 Christ Church Meadow, 1515.
 Christ Church, Oxford, 1367.
 Christians, 675.
 Christy, J. F., 2491.
 Chudleigh, 1837.
 Chudleigh, Sir John, 1837.
 Churchill, 2176.
 Church, John, 2209.
 Churwalden, 2555.
 Cicero, 2038.
 Cimapan, 1948.
 Cina, Wood of, 2209.
 Cincelli, 932.
 Cistercian Abbey of Flaxley, 1750.
 Cistna, 1002.
 Clairvaux, 1231.
 Clairvaux, 2073.
 Clanbrasil, Lord, 2294.
 Clanbrasil, Earl of, 110.
 Clanbrasil, Dowager Lady, 111.
 Clapton, 772.
 Clare, 747.
 Clare, Mr., 771.
 Clare Castle, 1227.
 Claremont, 71, 275.
 Clarendon, Earl of, 51.
 Clarke, Dr., 100.
 Clarke, John, 55.
 Clarke, Sir John, 1782.
 Claudian, 2534.
 Claudius, Emperor, 681.
 Claudius Perrault, 2038.
 Clavigero, Abbé, 2051.
 Clug, Mr., 2558.
 Clayton House, 1839.
 Clayton Priory, 1511.
 Clayton, Sir Robert, 1497.
 Clement of Alexandria, 785.
 Clemente, Don Roxas de, 1908.
 Clements, 46.
 Cleopatra, 791.
 Clerkenwell, Marquess of, 2065.
 Clerk, Sir Simon, 2397.
 Clervaux, 139.
 Cleveland, 184.
 Cliff, 1970.
 Clifton, 1776.
 Clifton Palace, 1767.
 Clifton Park, 1767.
 Clive, Lord, 71.
 Clonmel, 678.
 Clontarf Castle, 2068.
 Clontarf Churchyard, 2068.
 Clopton, Sir William, 53.
 Clovelly, 1746.
 Clovelly Park, 1746.
 Clumber Park, 829.
 Clusius, 147.
 Coalhurst, 1745.
 Cobbett, 183.
 Cobham, 71.
 Cobham Hall, 269.
 Cobham, Lord, 36.
 Codrington, Robert, 1391.
 Coffa, 548.
 Coker, 36.
 Colbert, 1352.
 Colchester, 130.
 Colchester, Lord, 1833.
 Cole, 515.

- Cole, James, 49.
 Cole, Master James, 717.
 Coleshill, 612.
 Coleman, Rev. John, 647.
 Coleridge, 1701.
 Colladon, 2263, 2269.
 Collet, 541.
 Collier, John, 1537.
 Collington House, 510.
 Collinson, 57.
 Collinson, Michael, 56.
 Collinson, Peter, 42.
 Collinton, 515.
 Colliton, Sir John, 81.
 Cologne, 1352.
 Collon, 108.
 Colombey, Metz, 1438.
 Colonial Farm, 2323.
 Colombier, 652.
 Colophon, 2335.
 Colquhoun, Captain, 2558.
 Colton, 1782.
 Columbière, 139.
 Columbus, 1302.
 Columella, 187.
 Colvill, Mr., 383.
 Comber, 2066.
 Combermere, 2091.
 Combermere Abbey, 1756.
 Combermere, Lord, 1756.
 Comely Bank, 105.
 Commenius, 1339.
 Commerson, 142.
 Compiègne, 1963.
 Compton, Bishop, 41.
 Compton House, 515.
 Compton, Spencer, 63.
 Conception, 2438.
 Condal, Anthony, 541.
 Condor, Mr., 1931.
 Conelly, Colonel, 2406.
 Connor, Captain, 383.
 Connely, 42.
 Conolly, Edward, 114.
 Consequa, 1509.
 Constable, Ambrose, 25.
 Constable, Thomas, 25.
 Constantine, Emperor, 1720.
 Constantinoff, Madame, 157.
 Constantinople, 172.
 Conti, 1965.
 Conway, Mr., 1820.
 Conyers, Colonel, 2327.
 Cook, Captain & E., 170. (and 38 other references).
 Cook, Moses, 46.
 Cooke, 59.
 Cooke and Co., 46.
 Cooke, Lucre, London, and Field, Messrs., 46.
 Cool, 1227.
 Coole, 419. (and 29 other references).
 Coombe, 266.
 Coombe Abbey, 290.
 Coomb-la-Ville, 133.
 Coombe Royal, 385.
 Coombe Wood, 1131.
 Cooper, 2138.
 Cooper, Josh., of New Jersey, 898.
 Cooper, T. H., 1838.
 Copenhagen, 154.
 Copland, Mr., 2224.
 Corbett, 36.
 Corbett, Bishop, 688.
 Corby Castle, 70.
 Corcovado, 2436.
 Cordova, 171.
 Cordus, 2008, 2029.
 Corfe, 587.
 Corinth, 1264.
 Cork, 1354.
 Cork Convent, at Cintra, 1914.
 Corley, 1738, 1840.
 Cornbury Park, 1840.
 Corne, 1956.
 Cornutus, 745.
 Cornwall, 1104.
 Correa, 278.
 Correa de Serra, M., 1383.
 Corsham, 290.
 Corsica, 998.
 Corydon, 1381.
 Cotherstone, 1978.
 Costorphine, 414.
 Cotes, E., 1391.
 Cothelstone, 1435.
 Cotswold Hills, 700.
 Cottam and Hallen, Messrs., 2531.
 Cotton, Sir G., 1756.
 Couan, 2310.
 Couatilloux, 2157.
 Couch, B., 620.
 Couch, Jonathan, 903.
 Court, 290.
 Coulter, Dr., 185.
 Courland, the late Duchess of, 148.
 Course, 503.
 Coursey, near Samer, 2462.
 Courtaisy Castle, 466.
 Couscliff, 979.
 Coutances, 138.
 Covent Garden Market, 1471.
 Coventry, Earl of, 73.
 Cowan, 1670.
 Cowan, Mr., 832.
 Cowdray, 266.
 Cowfold, 1017.
 Cowley, 1346.
 Cowman House, 269.
 Cowper, 574.
 Cowper, Earl, 1762.
 Cowthorpe, 1771.
 Cox, 372.
 Coxe, Edward, 1391.
 Cox, Bishop, 786.
 Crabowski, Dr. H., 1273.
 Cræsus, 2112.
 Craft, Daniel, 58.
 Craigie Hall, 515.
 Craig Lockhart, 1675.
 Craig-y-Barns, 2360.
 Craik, William, 101.
 Crann-more, 111.
 Cranmond House, 515.
 Cranbourne, 1754.
 Cranford, 1227.
 Cranmer, Archbishop, 1367.
 Cranmore, 2000.
 Crowhurst Churchyard, 2091.
 Croydon, 344.
 Crécy, 1963.
 Cree, John, 82.
 Cremona, 169.
 Crescentius, 187.
 Cressy, 1397.
 Crete, 2082.
 Creveidt, 1392.
 Crispus, Passienus, 1967.
 Croagh Patrick, 1116.
 Crocus, 2084.
 Crocker Tor, 1756.
 Croft Castle, 1394.
 Croft, Miss, 1357.
 Cromer, 1325.
 Crompton, 371.
 Cronwell, 100.
 Cronstadt, 2114.
 Crook, Sir George, 2040.
 Croome, 266. (and 93 other references).
 Crossgrove Priory, 1520.
 Crowcombe Court, 2425.
 Crowe, James, 1437.
 Cruickshanks, 1800.
 Cruise, Captain, 2449.
 Crum Castle, 2081.
 Crupton Castle, 2079.
 Cruzblanca, 2373.
 Cuckfield, 1745.
 Cuffhells, 622.
 Culford, 250.
 Cullen, 1267.
 Cullen, Dr., 596.
 Cullen House, 1394.
 Cullenswood, 115.
 Cullin, Sir Thomas G., 787.
 Culpeper, 1355.
 Culrose Woods, 977.
 Culzean Castle, 570.
 Cumber, 106.
 Cumberland House Fort, 753.
 Cumberland Mountains, 2193.
 Cuming, 544.
 Cunnemara, 1083.
 Cunningham, Allan, 2444.
 Cunningham, James, 2445.
 Cunningham, Richard, 2102.
 Cunsborough, 1778.
 Cupid, 791.
 Curling, Mr., 2326.
 Curtis, Mr., 252.
 Curtis, William, 75.
 Curtis, S., 700.
 Curtois, Dr., 251.
 Curzon, Hon. and Rev. Fred., 1839.
 Cybele, 2122.
 Cyclops, 2121.
 Cydon, 923.
 Cyllene, 2203.
 Cyparissus, 2472.
 Cypress Grove, 111. (and 29 other places).
 Cyprus, 230.
- D.
- Dacre, Lord, 509.
 Daick. See Dalwick.
 Dale, Dr. Thomas, 81.
 Dale, Mr., 1818.
 Dalechamp, 1456, 1845.
 Daigelly, 1745.
 Dalguise, 2355.
 Dalham Park, 840.
 Dalhousie Castle, 414.
 Dalhousie, Lord, 1905.
 Dalkeith Palace, 266.
 Dalkeith Park, 255.
 Dail, James, 1215.
 D'Allan, Seigneur, 1351.
 Dalmahoy, 91.
 Dalman, 2146.
 Dalmeny Park, 1394.
 Dalquharan, 1979.
 Dalrymple, Baron, 101.
 Dalrymple, Miss, 101.
 Dalwick, 93.
 Damascus, 487.
 Damascus, Archbishop of, 2409.
 Dandolo, Count, 1349.
 Danesbury, 2321.
 Daniels, Captain, 1149.
 Dannipace, 2383.
 Dantzic, 2113.
 Danville, 1041.
 Daphne, 1005.
 Darby, 46.
 D'Aremerberg, Duc, 145.
 Darley, 287.
 Darley Churchyard, 2071.
 Darlington, Dr., 708.
 Darmstadt, 1420.
 Darnawa Castle, 1225.
 Darnley, 2079.
 Darnley, Lord, at Cobham, 1794.
 Dartmoor, 1753.
 Dartmouth, 396.
 Darwin, Dr., 1769.
 D'Asso, 824.
 Daubenton, 1722.
 Daumont, 1843.
 Davall, M., 1580.
 David, 1463.
 Davidson, Mr., 2067.
 Davies, T. 1784.
 Davis, 1800.
 Davis, Mr., 1229.
 Davis, T., 1804.
 Davy, Sir Humphry, 947.
 Dawick. See Dalwick.
 Day, Daniel, 1759.
 D'Ayen, Duke, 137.

- De Bourbon, Gaston, 1300.
 De Bressieux, M., 1928.
 De Candocoste, M. Laigie, 2452.
 De Candolle, 110. (and 96 other references).
 De Candolle, M. Alphonse, 161.
 De Charpentier, M., 2364.
 De Courson, M., 2462.
 De Courval, Viscount, 2462.
 De Cubières, M., 1415.
 De Dijon, M. le Comte, 138.
 De Dunois, Count, 1263.
 De Evermere, Robt., 35.
 De Foucault, M., 1367.
 De Frangueville, J., 49.
 De Frangueville, Master John, 757.
 De Friso, Don Juan, 2363.
 De Geer, 2145.
 De Genlis, Madame, 787.
 De la Boessière, Marquis, Malle-ville, 2452.
 De la Gallesonière, M., 136.
 De la Gardie, Count, 155.
 De la Graudière, Bois, 2462.
 De la Peyrouse, M., 1901.
 De la Pryme, Rev. Abraham, 1775.
 De la Touche, M., 141.
 De Larminat, M., 2121. 2130. 2304.
 De Ligne, Prince, 149.
 De Lille, 2472.
 De L'Isle, Lord, 1763.
 De Magneville, M., 139.
 De Mallesherbes, Lemonnier, 137. 2452.
 De Marigli, M., 1910.
 De Montbron, M. le Comte, 139.
 De Morogues, Baron, 2452.
 De Perthuis, M., 1220.
 De Pontin, 185.
 De Pradel, Seigneur, 1352.
 De Rambuteau, M. le Comte, 2364.
 De Roos, Lord, 2351.
 De Saussure, 163.
 De Son, M., 370.
 De Sorgeril, M., Baumanoir, 2452.
 De St. Fargeau, Count, 2140.
 De Theis, 485.
 De Thury, Viscount Héricart, 2194.
 De Tristan, Count, 2452.
 De Tschoudi, Baron, 2452.
 De Wael, M. E., 144.
 De Warens, Madame, 1255.
 De Werneck, M., 2365.
 Deborah, 1720.
 Deck, Mr. J., 1388, 1389.
 Decker, Sir Matthew, 509.
 Deene Park, 1782. 1840.
 Deepdene, 373.
 Delamarre, 2106.
 Delaware, Lord, 1760.
 Delaunay, 973.
 Deleuze, 138.
 Dellie, 1507.
 Dellius, 1643.
 Demogiet, 2305.
 Demophoon, 678.
 Denainvilliers, 137.
 Dendariarena, Don Francisco, 2436.
 Denham Rectory, 1783.
 Dennis, George, 62.
 Dennis, Mr., 245.
 Denson, J., jun., 1045.
 Denson, J., sen., 1388.
 D'Entrecasteaux, 356.
 Depeham, 2539.
 Deptford, 1750.
 Derby, 1354.
 Der-el-Kheimer, 2406.
 Descomet, 160.
 Descomet, le Chevalier, 815.
 Desfontaines, 189. (and 34 other places).
 Deshayes, M., 1774.
 Desio, 1438.
 Deakford, 1238.
 Dessau, 153.
 Dessau, Duke of, 148.
 Deuvaux, 755.
 Deucalion, 1723.
 Devereux, Robert, 59.
 Devon, Earl of, 73.
 Devonshire, Duke of, 73.
 Diana, 791.
 Diana of Ephesus, 2406.
 Dick, Sir Alexander, 92.
 Dickson, Mr., 1533.
 Dickson, Archibald, 105.
 Dickson and Turnbull, Messrs., 1217.
 Dickson, Messrs. Archibald and Son, 1640.
 Dido, 1463.
 Dierville, M., 1042.
 Digby, Earls of, 36.
 Dijon, 1927.
 Dilkie, W., 1780.
 Dillenius, Dr., 75.
 Dillon, Baron, 1391.
 Dillwyn, L. W., 820.
 D'Incarville, 491.
 D'Incarville, Father, 82.
 Dingleberry, 1765.
 Dinbriestie Park, 230.
 Dioclesian, 2471.
 Diodoros Siculus, 2408.
 Dion, 1441.
 Dionysius, 2038.
 Dioscorides, 31 (and 28 other places).
 Dismal Swamp, 2476.
 Ditton Park, 371.
 Doddington, 466.
 Dodoens, Rambrot, 476.
 Dodona, 1723.
 Dodonæus, 234.
 Dolgely, 1763.
 Dombey, 142.
 Domenichino, 1665.
 Domitian, 755.
 Don, G., 188.
 Don of Forfar, 759. (and 34 other places).
 Don Professor, 245. (and 28 other references).
 Don Luis de Gongora, 1958.
 Donald, Mr., 757.
 Donaldson, Captain, 719.
 Donaldson, Mr., 1978.
 Donauschingen, 152.
 Doncaster, 2564.
 Donrey, 1927.
 Donn, 118.
 Donnegan, 232.
 Donnington, 1435.
 Donovan, 1603.
 Doody, Mr., 1024.
 Doonholm, 2001.
 Doonside, 1855.
 Dorking, 25.
 Dornbach, 150.
 Dornholm, 419.
 Dorothea, 792.
 Dortrecht, Dort, 2114.
 Doubiat, M., 2452.
 Douglas, David, 119. (and 45 other places).
 Douglisstown, 2139.
 Doulicet, M., Lay Fay, 2452.
 Dourfront, 1774.
 Dovaston, Mr., 465.
 Dovaston, John, 2062.
 Dovaston, J. F. M., 2068.
 Dover, 2074.
 Dowlais House, 471.
 Downie, Captain, 2449.
 Downs, 2574.
 Downshire, Marquess of, 115.
 Downton Castle, 702.
 Drake, Mr., 1345.
 Drake, Sir Francis, 256.
 Dralet, 1726.
 Dram, 2113.
 Drayton, 1747.
 Drayton Bassett, 1782.
 Drayton Green, 1172.
 Dresden, 153. 153. 274.
 Dronninggaard, 154.
 Dropsmore, 377. (and 67 other places).
 Drumlainrig Castle, 90.
 Drummond, Dr., 111.
 Drummond, Mr., 170.
 Dryander, Mr., 1303.
 Dryburgh Abbey, 2079.
 Dryden, 1784.
 Dryden, Sir John, 1777.
 Dublin, 10.
 Dubois, Charles, 55.
 Dubreuil, M., 1670.
 Ducarel, Dr., 23.
 Ducarel, M., 1966.
 Ducie, Lord, 24.
 Du Détroit, Abbé, 1773.
 Duddingston, 841.
 Dudley Castle, 1777.
 Duff House, 2354.
 Duffrenoy, M., 2149.
 Duganston, 2000.
 Du Hamel, 70. (and 72 other references).
 Duke, Rev. —, 2550.
 Dumbarton, 2091.
 Dumfries, 1836.
 Dumont, 257. 326. 493. 467. 610. 806. 807. 1442.
 Dumont de Courset, 139. 140. 142. 143. 189. 2293. 2452.
 Dunal, 316.
 Dunant, M., at Secheron, Geneva, 164.
 Duncan, Dr., 677.
 Duncan, Mr., 252.
 Dundalk, 106.
 Dundas, Sir David, 1755.
 Dundee, 105.
 Dunganstone, 116.
 Dunkeld, 91.
 Dunkeld House, 2307.
 Dunkerron, 1976.
 Dunkirk, 1350.
 Dunmore, 2162.
 Dunraven, Countess of, 2523.
 Dunraven, Earl of, 1227.
 Dunrobin Castle, 230.
 Dunstable, 1334.
 Du Petit Thouars, 1826.
 Duplessy, 2068.
 Dupplin, 2185.
 Duprats, 2449.
 Durand, Abbé, 1917.
 Durand de Lançon, M., 128.
 Durien, M., 2550.
 Durlach, 147. 1662.
 Durham, 616.
 Durham, Bishop of, 1393.
 Durham's Park, Bishop of, 1682.
 Du Roi, J. P., 190.
 Duthie, 2167.
 Duthel Pine Forests, 2165.
 Dutour, M., 2650.
 Du Trochet, 1002.
 Duvau, M., 559.
 Dwight, 2260.
 Dworetzkoj, 1697.
 Dunnington Castle, 772.
 Dyaart House, 716.
 E
 Eagle, Archibald, 104.
 Eagle and Henderson, 104.
 Earl's Court, 612.
 Earl's Court House, 1206.
 Earlamill, 1226.
 East Hampstead, 1860.
 Eastnor Castle, 414.
 Easton Park, 1940.
 Eastwell Park, 266.
 Eastwood, 209.
 East Tytherley, 2337.
 Eaton Hall, 565.

Ebers, M., 1831.
 Echlinville, 1905.
 Edelfieda, 1756.
 Eden, 2610.
 Eden, Garden of, 1023.
 Edens, J., 2263.
 Edge, Thomas Webb, 1840.
 Edgecumbe, 2000.
 Edgefield Court House, 2196.
 Edinburgh, 10.
 Edward I., 1767.
 Edward III., 1748.
 Edward IV., 2070.
 Edward VI., 73.
 Edward, Thomas, 2522.
 Edward the Black Prince, 1756.
 Edward the Confessor, 1747.
 Eggleston, 979.
 Egantine, 1229.
 Egypt, 2334.
 Ehrenberg, 950.
 Ehrhart, 1395.
 Eisenstadt, 150.
 Elagrub, 147.
 Elba, 469.
 Eldagsen, 152.
 Elfheimus, 1747.
 Elgin, 570.
 Ellis, 2491.
 Elizabeth, Queen, 232.
 Ellerslie, 1772.
 Ellen, J. 801.
 Ellicock, Dumfriesshire, 91.
 Elliot, 425.
 Ellis, 579.
 Ellis, Mr., 1189.
 Ellis, John, 70.
 Ellis, Rev. Wm., 77.
 El-Mersé, 2412.
 Eltham, 1121.
 Elvaston Castle, 290.
 Ely, 699.
 Ely House, 786.
 Elysian Fields, 941.
 Emeric, 1910.
 Emo Park, 2184.
 Emodi, 983.
 Emperor Akbar, 2430.
 Emperor Charles V., 1747.
 Endaleigh, 290.
 Endaleigh Cottage, 406.
 Enfield, 466.
 Enfield Chase, 1018.
 Enghien, 146.
 Englefield House, 965.
 Enniskillen, 1927.
 Enniskillen, Earl of, 114.
 Enville, 371.
 Ephesus, 2417.
 Epicurus, Groves of, 2038.
 Epirus, 1790.
 Epping Forest, 1541.
 Epsom, 131.
 Erfurt, 153.
 Erlangen, 1458.
 Ermenonville, 1669.
 Erne, Earl of, 2081.
 Ernest, Duke, 148.
 Errisbeg, 107.
 Erskine House, 625.
 Erucapilus, 2122.
 Esgov, 2071.
 Esler, 1090.
 Essex, Earl of, 59.
 Estremadura Forests, 1907.
 Etienne, 187.
 Ettlinger Thor, 1663.
 Eu, 1963.
 Eudistes of Coutances, 1979.
 Eugene IV., 2467.
 Eugene Aram, 2297.
 Euphorbus, 1331.
 Eve, 899.
 Evelyn, 25. (and 96 other places).
 Exeter, 192. 1748.
 Exeter, Marquess of, 1970.
 Exmouth, Lord, 1837.

Eyford House, 2585.
 Ezeiel, 2418.

F.

Fabricius, 782. 1827. 2141.
 Fagon, 995.
 Fairbairn, 74.
 Fairchild, 287.
 Fairchild, Thomas, 80, 81.
 Fairchild of Hoxton, 63.
 Fairfax, 2903.
 Falla, Messrs., 819.
 Farley, 2413.
 Farnese Hercules, 930.
 Farnham, 108.
 Farnham Castle, 966.
 Farnham, Lord, 108. 2332.
 Farquharson, of Martee, 2161.
 Farquharson, James, 2154.
 Farrer, Captain, 1150.
 Fassa, 786.
 Father Ximenes, 2050.
 Fau, Sir John, 2542.
 Faulkbourne Hall, 2427.
 Fawkes, 2009.
 Fawley, 1225.
 Fayetteville, 2258.
 Fayoum, 787.
 Fee, M., 493.
 Ferguson, Henry, 104.
 Fénelon, 308.
 Fennel, Mrs., 2580.
 Fermanagh, 909.
 Ferney, 163.
 Ferney Park, 163.
 Ferrard, Lord Viscount, 106.
 Ferry, M., 2468.
 Festus Pompeius, 1740.
 Févillée, Father, 2263.
 Field, 46.
 Fife, Earl of, 1957.
 Finborough Hall, 419.
 Finchley, 494.
 Finhaven, 34.
 Finhaven Castle, 90.
 Finlirig, 836.
 Fintelmann, M., 159.
 Fintray House, 1841.
 Fior, M., 995.
 Firth, Captain, 944.
 Fischer, Dr., 630.
 Fischer, M., Göttingen, 151.
 Fitzherbert, 35.
 Fitzstephen, 1750.
 Fitz Stephens, 1992.
 Fitzwilliam, Earl, 1853.
 Fleming, Dr., 941.
 Fletcher, Mr., 101.
 Flinders, Captain, 2442.
 Flitwick House, 406.
 Flora, 791.
 Florence, 396.
 Florence Court, 114. (and 30 other places).
 Florida, 522.
 Floy, Mr., 986.
 Flugge, 1600.
 Foligno, 727.
 Fontenay aux Roses, 787.
 Fonthill, 629.
 Forbes, Mr., 1096. (and 48 other places).
 Forby, Mr., 1492.
 Ford, Mr., 1399.
 Forfar, 335.
 Forest of Aragon, 171.
 Forest of Arden, 2590.
 Forest, Black, 151.
 Forest of Bois de Boulogne, 2452.
 Forest of Braemar, 2164.
 Forest of Brothome, 1774.
 Forest of Castle, 171.
 Forest of Cerlay, 1774.
 Forest of Charleville, 113.
 Forest of Châtellerault, 618.
 Forest of Compiègne, 2452.

Forest of Delamere, 1756.
 Forest of Dartmoor, 1756.
 Forest of Dean, 573.
 Forest of Dulnain, 2181.
 Forest of Fontainebleau, 140.
 Forest of Glenmore, 2161.
 Forest of Glentanner, 2156.
 Forest of Guadarrama, 171.
 Forest of Haguenau, 2145.
 Forest of Hatfield, 2116.
 Forest of Hercynia, 1790.
 Forest Hill, 1762.
 Forest of Hockwald, 2337.
 Forest of Invercauld, 2156. 2181.
 Forest of Ligny, 1334.
 Forests of Lithuania, 2157.
 Forests of Livonia, 2157.
 Forest Lodge, 2397.
 Forest of Lonca, 2204.
 Forest of Mar, 2156.
 Forest of Mareuil, 618.
 Forest of Montmorency, 1678.
 Forest of Orleans, 1989.
 Forest of Rannoch, 2116.
 Forest of Rastadt, 2177.
 Forest of Rospa, 2204.
 Forest of Rubia, 2333.
 Forest of Salecy, 1750.
 Forest of Segura, 171.
 Forest of Sierra de Cuenca, 171.
 Forest of St. Claude, 1334.
 Forest of St. Germain en Laye, 2000.
 Forest of Villers Cotterets, 2452.
 Forest of Wyre, 23.
 Fornace, 2091.
 Forskoel, 1948.
 Forster, 945.
 Forster, Edward, 1458.
 Forster, G., 2104.
 Foryth, W., 74.
 Fort Augustus, 1594.
 Fort George, 2320.
 Fort Mandon, 928.
 Fort Vancouver, 123.
 Fortescue, Earl of, 1854.
 Fortingal Churchyard, 2079.
 Forum of Augustus, 2357.
 Foster, Captain, 46.
 Foster, Mr., 2512.
 Foston Hall, 716.
 Fothergill, Dr., 71.
 Fougères, 1774.
 Fougereux de Bondaroy, M., 140.
 Fougereux, M., 2157.
 Fount, Colonel, 2568.
 Fountains Abbey, 2069.
 Fountain Bridge, 105.
 Fountain Hall, 466.
 Fournet, 1774.
 Fox, Honourable Mrs., 2406.
 Fox, Sir Stephen, 2413.
 Foxley, 1800.
 Fraiting, 2000.
 Framlingham, 1523. 1778.
 Francis I., 2457.
 Franconia, 2143.
 François, M., 617.
 Franconville, Park at, 2415.
 Francis I., 1352.
 Frankfort, 153. 1336.
 Frankfort on the Maine, 380.
 Frankfort, the Grand Duke of, 148.
 Franklin, Captain, 124.
 Franklin, Dr., 381.
 Fraser, Mr., 85.
 Fraser, Mrs. Christiana, 191.
 Fraser, Mr. Charles, 186.
 Fraser, Mr. John, 83.
 Fraser, Messrs., 84. 1894.
 Frederick II., 1322.
 Frederick Augustus IV., 148.
 Frederick the Great, 143.
 Frederick William IV., 148.
 Frederick William, late King of Wurtemberg, 148.
 Frencham, 515.
 Fredville, 1762.

Frazier, M., 519.
 Friburg, 161.
 Fries, 1487.
 Fries, Count, 147.
 Friga, 1082.
 Fromont, 272.
 Fromont on the Seine, 130.
 Froude, Archdeacon, 1786.
 Fuchsias, 236.
 Fulham, 35.
 Fulham Palace, 266. (and 32 other places).
 Fuller, 35.
 Fullerton, 1435.
 Furber, 77.
 Furber, of Kensington, 42.
 Furber, Robert, 81.

G.

Gaddington, 832.
 Gertner, 1085.
 Gainford, 980.
 Gainsborough, 1749.
 Galeb, 299.
 Galen, 684.
 Galicia, 410.
 Gallisonière, Admiral, 461.
 Galt, 2138.
 Galway, 2580.
 Gamlingay, 1215.
 Garcilasso, 1902.
 Garden, Dr. Alexander, 70.
 Gardner, Mr., 391.

Gardens:—

Alcaza, or Royal Palace of Seville, 2463.
 Alcinous, 16.
 Alhambra, 2463.
 Angot, M., 2493.
 Annet, 290.
 Arquebuse, 1635.
 Bernasconi, F., 648.
 Blackburne's, Mr., Oxford, 56.
 Boursau's, M., 206.
 Brunel's, M., 2475.
 Campbell's, 2067.
 Cape's, Mrs., 74.
 Capell's, Sir Henry, 45.
 Cavendish's, H., 2231.
 Cels's, M., Paris, 225.
 Chapultepec, Mexico, 2485.
 Château de Montigny, 2405.
 Chilvers's, Mrs., Finchley, 494.
 Christianholme, near Lolland, 154.
 Clambasill's, Lord, Louth, 108.
 Claremont, 54.
 Clifford's, 233.
 Collinson's, Peter, 58.
 Cork Institution, 130.
 Count de Vandes's, Bayswater, 386.
 Courset's, 258.
 Consequa's, 648.
 Crook's, G., 2526.
 Croome, 54.
 Crowe's, Mr., 1455.
 Cyrus the younger's, 16.
 Dean of Winchester's, 1367.
 De Girardin's, Marquis, 1699.
 De Noailles's, Maréchal, 141.
 De Tachoudi's, Baron C., 625.
 Devonshire's, Duke of, Chiswick, 7.
 Dickson's, Mrs., 344.
 Di Negro's, Signor, Genoa, 595.
 Dubois's, Chas., at Mitcham, 55.
 Duc d'Arenberg's, Enghien, 1161.
 Eden, Garden of, 15.
 English, at Caserta, 265. 275. 668.
 Essex's, Earl of, at Barn Elms, 38.
 Farsetti's, 169.
 Fennell's, Mr. Robert, 106.
 Foster's Captain, at Lambeth, 46.
 Fothergill's, Dr., Ham House, 1191.

Gardens—continued.

Fox's, Sir Stephen, at Chiswick, 45.
 Garnier's, Rev. Thomas, 955.
 Gerard's, Holborn, 591.
 Gerard's, Strand, 39.
 Goodrick's, Sir Harry, at Ribstone, 56.
 Gray's, Mr., 1195.
 Gurney's, Upton House, 7.
 Hall's, S. C., Kensington Gravel Pits, 1502. 1511.
 Hamilton's William, Woodlands, Philadelphia, 192.
 Harrison's, W., Cheshunt, 1122.
 Hatkinson's, R., 1659.
 Hopetoun House, Edinburgh, 2276.
 Inchiquin's, Lord, 107.
 King of the Belgians's, Lachen, 145.
 Kingston's, Lord, 108.
 Knight's, Mr., Canonbury Place, Islington, 1511.
 Lambert's, A. B., 843.
 Lawrence's, Mrs., 1172.
 Laye's, 564.
 Lemon's, Sir C., 1149.
 Lemonnier's, Versailles, 141. 2403.
 Lloyd's, Dr. Lumley, at Cheam, 56.
 London's, Bishop of Fulham, 7.
 London's, Baron, Hadersdorf, 1435.
 London's, J. C., Bayswater, 292.
 Malmaison, 143.
 Mansfield's, Earl of, 123.
 Marbouf's, 2415.
 Marryatt's, Mrs., 2463.
 Military Hospital, Avignon, 1370.
 Millerio's Count, near Milan, 169.
 Mitford's, Rev. J., 233.
 Molra's, Lord, Down, 46.
 Monna, the Viceregal, 168.
 Neill's, Dr., Canou Mills, 598.
 Negaaristan, 786.
 Negro's, Signor del, of Genoa, 168.
 New Posso, 98.
 Nichols's, J., 652.
 Nikitka, 159.
 Nile, 786.
 No. 1. Porchester Terrace, Bayswater, 1511.
 No. 2. Lee Place, Lewisham, 1511.
 Parker's, Mr., near Croydon, 56.
 Parkinson's, 2592.
 Parliament Close, 37.
 Percival's, Dr. Annfield, Dublin, 2262.
 Pérignon's, M., at Auteuil, 2201.
 Pernold's, M., 2100.
 Peterborough's, Lord, at Parson's Green, 55.
 Petersburg, 157.
 Petit Trianon, 263.
 Post-house, Old Street, Greenwich, 464.
 Raleigh's, Sir Walter, 2568.
 Reynardson's, at Hillingdon, 56.
 Soulange-Bodin's, M. le Chevalier, 22. 6.
 Sherard's, 235.
 Smetz's, M., 1951.
 Steinberg's, Baron, Bruggen, 152.
 Stevens's, Captain, Beaumont Square, Mile End, 1511.
 Strong, Mr., 308.
 Tankerville's, Lady, 948.
 Taurida Palace, Petersburg, 157.
 Temple Gardens, 34.
 Temple's Mr., 516.
 Temple's, Sir William, at West Sheen, 45.

Gardens—continued.

Tchitchagoff's, Admiral, 265.
 Tradescant's, South Lambeth, 40.
 Trelawney's, Sir Harry, Batta-head, 56.
 Tuggie's, Mrs., Westminster, 963.
 Tuggy's, Mr., 2522.
 Tzarsco Celo, 157.
 Veterinary School, at Alfort, 2213.
 Vilmsorin's, M., 654.
 Von Spreckelsen's, M., Hamburg, 2225.
 Wade's, Mr., Hampstead, 2469.
 Wales's, Princess Dowager of, Kew, 57.
 Walker's, Dr. Collington, Edinburgh, 89.
 Weber's, Lieutenant, Dresden, 151.
 Wellington's, Duke of, Apsley House, 1676.
 Whitehall, 37.
 Whitmill's, Mr., Hoxton, 718.
 Wilmot, Mr., Bow, 2522.
 Woronow's, Count, 152.
 Wood, J. Scoreby, 2321.
 Yates's, Mr., Salcombe Bay, Devonshire, 2289.

Gardens, Botanic:—
 Ahoft, 146.
 Amsterdam, 1847.
 Antwerp, 144.
 Avanches, 1708. (and 25 other places).
 Austria University, 291.
 Bastram's, Philadelphia, 182.
 Beaufort's, Duchess of, at Bodington, 47.
 Belfast Bot. and Hort., 130.
 Berlin, 151. (and 23 other places).
 Birmingham, 130.
 Brussels, 145.
 Bury St. Edmunds, 321.
 Cambridge, 245.
 Carlsruhe, 1111.
 Carr's, Philadelphia, 381.
 Chelsea, 47. (and 75 other places).
 Copenhagen, 2089.)
 Colchester, 130.
 Cork, 2558.
 Curtis's, William, at Bernardssey, 75.
 At Lambeth Marsh, 75.
 At Brompton, 75.
 Dimidow's, in Russia, 158.
 Dresden, 151.
 Dublin, 1467.
 Edinburgh, 48. (and 46 other places).
 Edinburgh, New, 1121.
 Eitham, 715.
 Erlang, 1456.
 French Colonial, Algiers, 226.
 Geneva, 161, 162. 491.
 Ghent, 145.
 Giessen, 149.
 Glasgow, 123. (and 30 other places).
 Glasnevin, 11. (and 64 other places).
 Göttingen, 462. (and 40 other places).
 Holyrood, 25.
 Hull, 130.
 Inverleith, 2438.
 Jardin des Plantes, 259. (and 30 other places).
 Kew, 75. (and 103 other places).
 Kingessing, Pennsylvania, 85.
 Leyden, 143.
 Lisbon, 170.
 Liverpool, 130. 1073.
 Lund, 372.
 Louvain, 386.

- Gardens, Botanic — *continued*.
 Manchester, 130.
 Metz, 657.
 Montpellier, 1364.
 Monza, 2453.
 Munich, 151. (and; 40 other places).
 North Loch, 95.
 Nuremberg, 143.
 Oxford, 47. (and 56 other places).
 Padua, 169.
 Padua, 264.
 Paris, 136.
 Pavia, 2100.
 Pesth, 150.
 Pisa, 264.
 Ray's, in Essex, 47.
 Riensel, 143.
 Rouen, 977.
 Salisbury's, William, 75.
 Sheffield, 130.
 Sherrard's, Dr. James, at Eltham, 75.
 Sloane's, Sir Hans, at Chelsea, 47.
 Somerset's, Edward Duke of, Syon, 73.
 Strasburg, 2093.
 St. Petersburg, 116.
 St. Vincent's, 1719.
 Sydney, 186.
 Toulon, 266. (and 44 other places).
 Toulouse, 1735.
 Trianon, 157.
 Trinity College, Dublin, 108.
 Twickenham, 58. (and 16 other references).
 Ussal, 1171.
 Utrecht, 2095.
 Uvedale's, Dr., at Enfield, 47.
 Vienna University Garden, 150. (and 360 other places).
 Warsaw, 815.
 Gardens Horticultural:—
 Caledonian, 11.
 Dollar Institution, 411.
 Inverleith, 1403.
 London, at Chiswick, 75. (and 470 other places).
 Gardens, Public:—
 Kensington, 497.
 Munich, 291.
 Gardens, Royal:—
 Berlin, 1416.
 Copenhagen, 516.
 Fontainebleau, 2457.
 Hampton Court, 51.
 Kew, 74.
 Monza, 626.
 Nymphenburg, 151.
 Paris, 1417.
 Pilnitz, 151.
 Rosenberg, 2453.
 St. James's, 51.
 Strelina, 157.
 Gardens, Zoological:—
 Regent's Park, 1858.
 Surrey, 821.
 Gardenstone, Lord, 1662.
 Garidel, M., 1910.
 Garnier, Rev. Thomas, 1178.
 Garry, Hudson, 1841.
 Garry, Nicholas, 2031.
 Gartmore, 2363.
 Gastrell, Mr., 1346.
 Gate House, 95.
 Gates, Mr., 2449.
 Gaudichaud, 2508.
 Gaul, 1721.
 Gaulther, 1125.
 Gaulther, M., 2212.
 Gausen, M., of Chapeaurouge, 163.
 Gausen de Chapeaurouge, M., 2096.
 Gausen, M., Bourdigny, 163.
 Gautieri, 220.
 Gavarme, 2188.
 Gedé Mountain, 1937.
 Gee, Mr. R., 1583.
 Gehol, 304.
 Gemmellaro, 1987.
 Gendall, J., 1837.
 Generalife at Grenada, Palace of the, 2471.
 Geneva, 150.
 Genoa, 940.
 Gents, M., 154.
 Geoffroy, 1241.
 George I., 80.
 George II., 81.
 George III., 82.
 George IV., 1754.
 George Town, 1919.
 Gerard, 24. (and 91 other places).
 Gerard, Captain P., 2254.
 Gerber, 1369.
 Gerthy, 290.
 Gesner, 2008.
 Ghent, 145.
 Gibraltar, 1923.
 Gibbons, 2540.
 Gibson, 45.
 Giessen, 148.
 Gillies, Dr., 558.
 Gilpin, 100. (and 48 other places).
 Giraldu Cambrensis, 1830.
 Girling, Mr., of Hovingham, 1812.
 Glasgow, 105.
 Glasnevin, 116.
 Glastonbury, 22.
 Glastonbury Abbey, 833.
 Glastonbury Churchyard, 1431.
 Glazenwood, Essex, 252.
 Glashow, near Leeds, 2278.
 Gleditsch, Gottlieb, 650.
 Glen, Callater, 1594.
 Glen Dee, 2185.
 Glendalough Churchyard, 2082.
 Gleneagles, 2185.
 Glen Lyon, 2079.
 Glenmore, 2167.
 Glenmore Forest, 2169.
 Glen Nevis, 1579.
 Glennie, Lieutenant, 2110.
 Glen Tarfe, 1584.
 Gloucester Cathedral, 1748.
 Gloucester, Duke of, 1393.
 Gloucester Lodge, 489.
 Gmelin, 1055.
 Goat's Island, 2456.
 Godfrey of Ville d'Avray, 2201.
 Goderich, 183.
 Godfrey (or Godby), Sir Theodore, 1762.
 Godsal, Mr., 1255.
 Godstone, 648.
 Gogar House, 1394.
 Goldbach, 740.
 Golden Grove, 266.
 Goldie, Mr., of Monkwood, 1047.
 Goldsmith, 839.
 Gollus, 1321.
 Goodrich Castle, 1778.
 Goodrick, Sir Harry, of Ribstone, 56.
 Goodwood, 59.
 Goodwood Park Lodge, 1905.
 Goodwyn, 1902.
 Googe, 35.
 Goose Creek, 1447. 1919.
 Gopsall, 1840.
 Gordon, 178.
 Gordon Castle, 270. (and 43 other places).
 Gordon, Duke of, 2161.
 Gordon, Alexander, 1282.
 Gordon, Mr., Mile End, 257.
 Gordon, G., 816. (and 28 other places).
 Gordon, James, 77.
 Gordon Robert, 1758.
 Goringki, 158.
 Gormanstown, Lord, 840.
 Gorrie, Mr., 861.
 Gosainthan, 967.
 Gosford House, 280.
 Goshen, 1273.
 Gosier, Abbé, 1670.
 Gostling, J., 2417.
 Gostling, Misses, 38.
 Gothe, 225.
 Gottenburg, 154.
 Göttingen, 151.
 Gouan, 548.
 Gough, 36.
 Govan, Dr., of Cupar, 2518.
 Governor King, 2443.
 Governor Philip, 2442.
 Gow, Mr., 1178.
 Gower, 2017.
 Gower, W. Leveson, 646, 647.
 Graef, 850.
 Graham, Dr., 89.
 Gralnger, Mr., 1773.
 Grammont, 1906.
 Grampian Mountains, 1085.
 Grandfather Mountain, 2139.
 Grange, 884.
 Grange Hall, 1978.
 Grange House, 625.
 Grant, Sir Archibald, 104.
 Grant, George Macpherson, 2120.
 Grant, Sir John Peter, 2166.
 Granville, 1390.
 Graves, Mr., 1834.
 Gravesend, 486.
 Gray, 37.
 Gray, the poet, 100.
 Gray, Christopher, of Fulham, 81.
 Gray, Dr., 40.
 Gray, Edward, 386.
 Gray, Earl, 1841.
 Gray House, 1841.
 Gray of Fulham, 42.
 Gray and Son, 47.
 Gray and Wear, 47.
 Gray's Inn Walks, 1391.
 Great Canford, 2000.
 Great Livermere, 625.
 Great Mogul, 785.
 Great Tew, 1670.
 Gredington, 1394.
 Gredlington, 1839.
 Greene, 486.
 Green Park, 1392.
 Greening, John, 82.
 Greenstead Church, 1748.
 Greenwich, 2469.
 Greenwich Park, 1904.
 Gregory the Great, 2071.
 Grenoble, 1326.
 Grenville, Lady, 2120.
 Grenville, Lord, 1779. 2430. 2445.
 Gresford Churchyard, 2078.
 Gresham, Sir Thomas, 1353.
 Gressier, 1255.
 Greville, Dr., 107.
 Grew, 61.
 Grey, Christopher, 909.
 Grierson, Mr., 1977.
 Grigor, Messrs. A. and J., 2156.
 Grigor, Mr., of Elgin, 2180.
 Grigor, Mr., of Forres, 2161.
 Griston, 1837.
 Grimoaldus, 1956.
 Grimstone, 290. (and 32 other places).
 Grimwood, Daniel, 83.
 Grindal, Bishop of London, 35.
 Grindall, Dr., 947.
 Grose, 1778.
 Guanajuato, 1944.
 Guelderland, 1040.
 Guernsey, 2549.
 Guerspain, M., 564.
 Guildford, Earl of, 1219.
 Guildhall, 1754.
 Guillemeau, 740.
 Gimpel, F., 190.
 Gildenstadt, 674.

Gulf of Bothnia, 1165.
 Gulf of Mundania, 578.
 Gunnersbury Park, 653.
 Günther, 1891.
 Gurney, S., 72.
 Gurwahi, or Garnwhal, 1922.
 Gussone, 1925.
 Guttenburg, 1336.
 Gwachmal, 899.
 Gyllenbrook, Baron, 155.
 Gyllenhall, 2141.

H.

Hackney, 1148.
 Hackness, 419.
 Hackwood Park, 1837.
 Haddington, 103.
 Haddington, Earl of, 102.
 Haddo House, 2120.
 Hadersdorf, 150.
 Hadgiabad, 940.
 Hadzor House, 419.
 Haffeld, 1831.
 Hafiz, near Shiraz, 2471.
 Hafod, 730.
 Hafton, 430.
 Hagley, 290.
 Hagley Park, 1925.
 Hague, 144.
 Hainault Forest, 1759.
 Hake, Baron, 152.
 Hakluyt, 35.
 Haklon Hill, 1837.
 Haklon House, 1837.
 Hales, Dr. Stephen, 1189.
 Halifax, 1899.
 Halkett, C. Cragie, 2120.
 Hall, Captain, 2117.
 Hall, S. C., 1262.
 Haller, 494.
 Halliday, J., 1969.
 Halton, 466.
 Hamadryads, 1725.
 Hamburg, 153.
 Ham House, 428. (and 38 other places).
 Hamilton, 869.
 Hamilton, Dr., 245.
 Hamilton, Dukes of, 92.
 Hamilton, Honble. Charles, 70.
 Hamilton, Mr., 2096.
 Hamilton, Mr. Charles, 106.
 Hamilton Palace, 90.
 Hamilton Park, 93.
 Hamilton, William, 181.
 Hammersmith, 131.
 Hampstead, 403.
 Hampstead Heath, 997.
 Hampstead, Marshall, 515.
 Hampton Court, 1644.
 Hampton Court Park, 1392.
 Hampton Lodge, 2325.
 Hamrange, 2139.
 Hanau, 1426.
 Hanbury, 188.
 Hanbury, Osgood, 2426.
 Hannay, William, 97.
 Hannay of Kirkdale, 96.
 Hanwell, 2426.
 Hanwell Lunatic Asylum, 1514.
 Happy City, 1756.
 Harbeck, 148.
 Harding, 203.
 Hardwicke, Colonel, 759.
 Hardwicke, Earl of, 1215.
 Hardwicke Grange, 593.
 Hardy, Mr., 750.
 Harefield Park, 52.
 Harefield Place, 1904.
 Harleyford, 1829.
 Harlingford, 2185.
 Harlington Churchyard, 9069.
 Haroko, 151.
 Harold, 2070.
 Harpocrates 791.
 Harringay, 266.
 Harris, Richard, 696.

Harrisburgh, 611.
 Harrison, Josh., 614.
 Harrison, Thomas, 1777.
 Harrison, William, 2120.
 Harrowby, Earl of, 700.
 Harry Percy, 1768.
 Harburn, 1840.
 Harte, 2358.
 Hartig, M., 416.
 Hartlib, 1353.
 Hartog, J., 504.
 Hartweg, 260.
 Hartwood, 2904.
 Harts Forests, 2143.
 Hasselquist, 526.
 Hassendeanburn, 105.
 Hassenfrats, M., 2040.
 Hassop, 2427.
 Hasted, 24.
 Hastings, Marquess of, 2254.
 Hatfield, 266.
 Hatfield Bog, 1731.
 Hatfield Chase, 1775.
 Hatfield Forest, 1721.
 Hatherton, Lord, 1803.
 Hatton, Sir Christopher, 786.
 Hatton House, 1979.
 Haughton, Graves, 1714.
 Hault Bouonnais, 143.
 Havre, 1774.
 Havre de Grace, 1390.
 Hawick, 105.
 Hawkins, Mr., 97.
 Haworth, 811.
 Hay, Drummond, 2407.
 Hayes, 515.
 Hayes's Place, 1275.
 Hayne, F. G., 190.
 Hazelbury, 2019.
 Hazelingfield, 2019.
 Haslemere, 1331.
 Haxxi, M., 1322.
 Head, Sir Francis, 681.
 Head, Sir George, 2539.
 Headrick, Rev. James, 100.
 Heathcoat, John, 1354.
 Heber, Bishop, 2430.
 Hecate, 1724.
 Hecuba, 1108.
 Hecker, 1023.
 Hecks, 2091.
 Heer, Dr., 2141.
 Heffleton, 2354.
 Heidelberg, 1426.
 Heia, 1023.
 Helen, 2037.
 Helenus, 1723.
 Hellades, 1654. 1683.
 Heligan, 1020.
 Heliogabalus, 1351.
 Helsingborg, 2113.
 Hempstead, 1830.
 Hen-jerson, Mr., 1953. 2535.
 Hendon, 57.
 Hendon Rectory, 2189.
 Henfield, 1458. (and 53 other places).
 Henlian, 2071.
 Henly, Lord, 1017.
 Henshaw, Rev. Mr., 326.
 Henslow, Professor, 415.
 Henrietta, Maria, Queen of Charles I., 696.
 Henry I., 1750.
 Henry II., 33.
 Henry III., 896.
 Henry IV., 33.
 Henry V., 696.
 Henry VI., 512.
 Henry VII., 787.
 Henry VIII., 31.
 Henry of Huntingdon, 1750.
 Henry of Lancaster, 793.
 Hepworth, Rev. Mr., 1215.
 Herbert, Hon. and Rev. W., 2426.
 Herculeanum, 2238.
 Hercules, 899.

Hercynian Forest, 1794.
 Hereford, 965.
 Hereford, Earl of, 33.
 Hereschach, 187.
 Hereschach, 95.
 Héricart de Thury, Viscount, 138.
 Hermann, 41.
 Hernandez, Francis, 2060.
 Herne, 1576.
 Herne, 1764.
 Herodotus, 16.
 Heron, Andrew, 95.
 Heron, Dr. Andrew, 96.
 Heron, Captain Basil, 98.
 Herrenhausen, 151.
 Herrera, 187.
 Herrick, 1463.
 Herry, Mariakirk, 145.
 Herioid, 16.
 Hesse, the Elector of, 148.
 Hestercombe, 290.
 Hethel Church, Norwich, 940.
 Hetheret, 1523.
 Hières, 2298.
 High Clerc, 73.
 Highgate, 403.
 Highlands, 668.
 Hilda, 190.
 Hill, Aaron, 1957.
 Hill, Dr., 75.
 Hill, Dr. John, 80.
 Hill, Mr., 1864.
 Hill, Sir John, 378.
 Hillbrook, 2184.
 Hillhall, 1392.
 Hillieri, 1720.
 Hillingdon, 61.
 Hillingdon, 2419.
 Hillsborough, 115.
 Hillsborough Castle, 1842.
 Hilton Park, 2334.
 Himley, 1833.
 Himley Hall, 2092.
 Hinchingsbrook, 251.
 Hinuber, 148.
 Hinton House, 819.
 Hippocrates, 248.
 Hippocrenes, 930.
 Hiram, 940.
 Hiram, King of Tyre, 2408.
 Hirpinus, 2040.
 Hirsch, 820.
 Hitchin Priory, 2000.
 Hoare, C., 326.
 Hoare, Sir Richard Colt, 1763.
 Hobart Town, 186.
 Hobbs, Roger, Abbot of Woburn, 1753.
 Hobhouse, 2042.
 Hockwold, near Strasburg, 2335.
 Hockkin, Mr., 916.
 Hodgson, Dr., 89.
 Hoffman, M., 151.
 Hogg, Mr., 16.
 Hogg, Thomas, 2560.
 Holbein, 368.
 Holboorne, 92.
 Hollnshed, 31.
 Holker Hall, 1840.
 Holkheim, 683.
 Holland, Dr., 526.
 Holland, Lord, 2413.
 Holland House, 2285.
 Hollar, 1391.
 Holloway, Sally, 918.
 Hollowell, 2285.
 Holm, 625.
 Holme Castle, 515.
 Holmes, Mr., 1520.
 Holmedale Castle, 515.
 Holstein, 1023.
 Holt Forest, 1761.
 Holtwood House, 91.
 Hømer, 16.
 Hom-Lacey, 888.
 Hone, 919.
 Hong, Emperor, 1350.

- Hooker, Sir W. J., 27.
 Hooker, Dr., 240. (and 61 other places).
 Hooker, of Brenchley, 757.
 Hope, Dr., 83.
 Hope, Dr. John, 1657.
 Hope, Rev. F. W., 2140.
 Hopetoun, Earl of, 102.
 Hopetoun House, 91.
 Hopkins, Benjamin Bond, 71.
 Hopton, 1539.
 Horace, 1005.
 Horatius Cocles, 1748.
 Horford, 371.
 Hornby Castle, 716.
 Horneman, 821.
 Hornsey, 772.
 Horsefield, Dr., 1820.
 Horseydowne, 682.
 Horstadius, 2333.
 Hosterdt, 1684.
 Hôse, 1637.
 Host, 1456.
 Hotspur, 1768.
 Houel, M., 1963.
 Hounslow, 1682.
 Hounslow, Churchyard at, 2081.
 Hounslow Heath, 573.
 House of the Forest of Lebanon, 2408.
 Houston, Dr., 1276.
 Houton, 2085.
 Hove, 369.
 Hoven, D., 541.
 Hovingham Hall, 1841.
 Howard, Hon. C., 51.
 Howe, Earl, 1840.
 Howe's Park, 1839.
 Howell Sele, 1763.
 Howison, Dr., 2175.
 Howitt, Mary, 1086.
 Howitt, Mrs., 2540.
 Howitt, W., 1036.
 Howth Castle, 113.
 Hoxton, 718.
 Huddersfield, 1659.
 Hudson, 27.
 Hudson, William, 354.
 Hugh, 2073.
 Huilquiquica, 1948.
 Hull, 130.
 Hull, Dr., 1084.
 Humbeque, Brussels, 815.
 Humboldt, Baron von, 121.
 Humboldt and Bonpland, 2065.
 Hume, Lady Amelia, 373.
 Hume, Sir Abraham, 118.
 Hunneman, Mr., 794.
 Hunt, F. and S., 63.
 Hunt, Leigh, 1669.
 Hunter, Captain, 2442.
 Hunter, Dr. A., 80.
 Hunter, Percival, 2080.
 Hunter, W. H., 1772.
 Huntingdon, 1404.
 Huntley Lodge, 1190.
 Hurdis, 574.
 Hursley Park, 1837.
 Hurton House, 1881.
 Hyde Park, 744.
 Hyland, 2082.
 Hyland, Mr. William, 251.
 Hylands, 497.
 Hyle, 1643.
 Hymen, 1430.
 Hyndford, Earl of, 102.
 Hyrcania, 1195.
- I.
- Ibrahim Paşa, Cairo, 2406.
 Ickham, 1536.
 Iduna, 899.
 Illey Churchyard, 2076.
 Illos Foss, 2302.
 Ihu, 1720.
 Imaretta, 1410.
 Inch Buckling Brae, 836.
 Ingils, Mr., 2074.
 Ingress Park, 1003.
 Inisfallen Island, 515.
 Inman, Dr., 618.
 Inver, 2361.
 Inverallen, 2166.
 Inverary, 1957, 1979.
 Inverary Castle, 91.
 Invercauld, 2154.
 Inverleith, Experimental Garden, 883.
 Invermay, 2310.
 Inverness, 570.
 Ionia, 1720.
 Irby, Captain, 1931.
 Ireland, Mr., 2183.
 Isaac, 1720.
 Isalah, 902.
 Island of Burmudas, 2498.
 Island of Corsica, 2302.
 Island of Cos (Stancbio), 2042.
 Island of Diomedes, 2038.
 Island of Hierro, 1667.
 Island of Inch Lonach, 2080.
 Island of Lampedusa, 1233.
 Island of Lewis, 1641.
 Island of Loch Leven, 1226.
 Island of Montreal, 1057.
 Island of Montserrat, 2101.
 Island of Nippon, 2395.
 Island of Rügen, 2585.
 Island of Scio, 548.
 Island of Sitcha, 1152.
 Island of Sosnovy Kosha, 2186.
 Island of St. Helena, 1509.
 Island of St. Vincent, 942.
 Island of Zacynthus (Zante), 2409.
 Islay, Earl of, 62.
 Isle of Bernera, 2080.
 Isle of Bourbon, 1361.
 Isle of Bute, 2001.
 Isle of Crete, 1283.
 Isle of Cyprus, 2408.
 Isle of Ely, 227.
 Isle of Iala, 277.
 Isle of Jersey, 593.
 Isle of Man, 2360.
 Isle of Mull, 1646.
 Isle of Oxney, 1749.
 Isle of Palma, 2324.
 Isle of Pines, 2442.
 Isle of Poplars, 1669.
 Isle of Portland, 1277.
 Isle of Wight, 963.
 Isleworth, 266.
 Islington, Marquess of, 2086.
 Ivoy, M., 139.
 Ixmiquilpan, 1948.
- J.
- Jackson, 786.
 Jackson, George, 569.
 Jacob, 2020.
 Jacques, 129.
 Jacquin, 247.
 Jacquin, Baron, 146.
 Jacquin, Dr. Nicholas, 83.
 Jägersborg, 154.
 Jahn, 677.
 Jalacinga, 2273.
 Jalapa, 1014.
 James I., 34.
 James III., 34.
 James V., 94.
 James VI., 888.
 Jansen, Chevalier, 137.
 Jardin du Val, 826.
 Jardine Hall, 1979.
 Jardine, Sir Wm., 2079.
 Jaune St. Hilaire, M., 189.
 Jean of Arragon, 1987.
 Jedburgh, 1772.
 Jedburgh Abbey, 888.
 Jedo, 2462.
 Jeffries, 47.
 Jeffries and Gray, 47.
 Jenica, 1696.
 Jerusalem, 418.
 Jerusalem, Temple of, 2408.
 Jesse, Mr., 1392.
 Jessup, Ebeneser, 615.
 Johnson, 613.
 Johnson, Colonel, 2039.
 Johnson, Dr., 1518.
 Johnson, W. C., 2067.
 Johnston, 2127.
 Johnston, Dr., 818. ¶
 Johnston, John, 187.
 Johnstone, Mr., 2092.
 Johnstone, Hope, 1771.
 Joinville, Prince de, 2412.
 Jones, Dr. Trevor, 1519.
 Jones, Inigo, 73.
 Jones, Mr., 183.
 Jonson, Ben, 36.
 Joppa, 2510.
 Joseph I., 1339.
 Joseph of Arimathea, 833.
 Josephine, Crown Princess, 155.
 Josephine, Empress, 79.
 Josephus, 528.
 Joshua, 1720.
 Josselyn, 2314.
 Jove, 1724.
 Juba, King of Mauritania, 1331.
 Judas, 638.
 Jukes, H. W., 1742.
 Julius Cesar, 1351.
 Ju gfran, 2307.
 Ju stas, 941.
 Jupiter, Æneides, 2325.
 Jupiter Ammon, 1722.
 Jupiter Statue of, 2407.
 Jura, 1737.
 Jussieu, 393.
 Jussieu, Josh., 1274.
 Justinian, Emperor, 1351.
 K.
 Kämpfer, 141.
 Kaima, Lord, 88.
 Kalm, 551.
 Kalm, Peter, 1151.
 Kamrup, or Kamroop, 1922.
 Kanobin, 2412.
 Karwinski, Baron, 2527.
 Kathofer, 2276.
 Katherine, 839.
 Katmandu, 1014.
 Katsa, 1701.
 Keddieston, 466.
 Keen, Mr., 1425.
 Kelsal, Mr., 2087.
 Kempton, 515.
 Kenilworth, 1359.
 Kennebeck, 2282.
 Kennedy, Lewis, 63.
 Kennedy and Lee, Messrs., 81.
 Kennity Church, 1227.
 Kensington, 616.
 Kensington Gore, 272.
 Kent, 54.
 Kent, Miss, 463.
 Kent, Nathaniel, 1993.
 Kent, N., 2219.
 Kenton, 624.
 Kenwood, 371. (and 87 other places).
 Kenyon, Lord, 1829.
 K'Eogh, J., 107.
 Keowe, 276.
 Ker, Wm., 2446.
 Kernanacha, 949.
 Kern Wood, 1736.
 Kerr, Lord Monk, 97.
 Kerry, 107.
 Kidbrooke, 491.
 Kilburn, 1334.
 Kildare, 1393.
 Kildare, Bishop of, 2083.
 Killeuzie, 1287.
 Kilkenny, 116.
 Kilkerran, 625.
 Killarney, 34.

- Kiffertou, 266. (and 19 other
 places)
 Killick, 1785.
 Killin, 1577.
 Killruderly House, 114.
 Kilmalic Churchyard, 1296.
 Kilmarnock, 105.
 Kilmington Rectory, 1072.
 Kilruderly, 1905.
 Kimberley, 1044.
 Kin, M., 2187.
 Kincardine, 2092.
 Kinfauns, 89.
 Kinfauns Castle, 491.
 King Ahab, 2401.
 King Alfred, 1749.
 King Arthur, 1753.
 King, Captain, 305.
 King David I., 90.
 King Demetrius, 2408.
 King Edgar, 1749.
 King George's Sound, 964.
 King Ina, 1746.
 King James, 1762.
 King John, 33.
 King John's Palace at Eltham,
 1747.
 King, Lord, 619.
 King Stephen, 1999.
 Kingsbridge, 484.
 King's Room, Stirling Castle,
 1748.
 Kingston, 1644.
 Kingston, America, 2212.
 Kingston, Duchess of, 1837.
 Kingston Hill, 1771.
 Kingston upon Thames, 764.
 Kingsweston, 2185.
 Kinlet, 290.
 Kincairney, 1217.
 Kinkarochie, 840.
 Kinmel Park, 414.
 Kinnaird Castle, 625.
 Kinnear, 2411.
 Kinnordy, 710.
 Kiow, 417.
 Kinross, 92.
 Kippenross, 89.
 Kirby, 1480.
 Kirby, Rev. W., 2142.
 Kirby and Spence, Messrs., 1815.
 Kircher, 1968.
 Kirkby Lonsdale, 1573.
 Kirzschinval, 766.
 Kitabel, 372.
 Kitley, 396.
 Knatchbull, Sir Wyndham, 2283.
 Kneedington, 290.
 Knight, 118.
 Knight, T. A., 896.
 Knowle, 371.
 Knoxville, 2196.
 Koch, 1453. (and 33 other places).
 Kollreuter, John Theophilus, 300.
 Königsberg, 2300.
 Kops, Professor, 2095.
 Kopenski, 921.
 Kopenski Berg, 150.
 Kotzebue's Sound, 1155.
 Koul, 2157.
 Kowno, 269.
 Krause, 189.
 Kremlin, the, Moscow, 1696.
 Kroglevin, Pass of, 2300.
 Kunawar, 950.
 Kurdistan, 1781.
 Kurile Isles, 2300.

 L.
 La Billardière, J. J. J., 356.
 La Bresse, 1991.
 La Celle, 2000.
 La Curva, 1948.
 La Fontaine, 1415.
 La Gascu, 170.
 La Mancha, 1719.
 La Peyrouse, M., 2300.
 La Plata, 1122.
 La Roque, 2409.
 La Venta de Agaguissola, 1942.]
 La Venta de la Mojonera, 1942.
 Lac d'Oo, 2188.
 Lac de Gaub, 2188.
 Lacalle, 587.
 Lacedæmonia, 1016.
 Lücken, 145.
 Ladakh, Forests of, 2429.
 Laertes, 835.
 Lahill, 2319.
 Laing, Dr., 953.
 Laing, Mr., 2173.
 Laing, Samuel, 2304.
 Lake Balkal, 835.
 Lake Erie, 1438.
 Lake Huron, 970.
 Lake Michigan, 1127.
 Lake Mistassina, 1069.
 Lake Noor-Laisan, 948.
 Lake Ontario, 1407.
 Lake of Petrovskoyé, 1694.
 Lake of Winnipeg, 1057.
 Lakes of Killarney, 509.
 Laleham Common, 1837.
 Lamarck, 141.
 Lamb, E. B., 794.
 Lambarole, 25.
 Lambert, A. B., 54. (and 64 other
 places).
 Lambeth, 40.
 Lambeth Palace, 1344.
 Lampascus, 2112.
 Lanark, 100.
 Lancaster, Pennsylvania, 612.
 Lancaster Friends' Burying-
 Ground, 419.
 Lance, Mr., 2476.
 Landes, near Bordeaux, 1718.
 Landguard Fort, 948.
 Langham Park, 421.
 Langles, 787.
 Langley, Batty, 80.
 Langres, 1927.
 Lansdowne, Marquess of, 71.
 Lantrissant, 1839.
 Laodicea, 1213.
 Lapeaute, M., 996.
 Lapeaute, Madame Hortense, 966.
 Largo House, 716.
 Largs, 1841.
 Larnunn, 2357.
 Larkin, Mr., 1809.
 Latham House, 290.
 Latrielle, 2141.
 Lauder, Sir Thomas Dick, 89. (and
 48 other places).
 Lauderdale, Duchess of, 57.
 Laulnay, 1979.
 Laure, M., 2412.
 Lauretine, 1298.
 Laurwig, 2302.
 Lavina, 932.
 Lawrs, 9001.
 Lawrence, Michael, 761.
 Lawrence, Miss, 749.
 Lawrence, Mrs., 1841.
 Lawrence, Charles, 573.
 Lawson, Messrs., 2156.
 Lawson's Museum, Edinburgh,
 2154.
 Laxenburg, 150.
 Laye, 915.
 Le Comte, M., of Riceborough,
 2135.
 Le Comte, 2528.
 Le Conte, 278.
 Le Jeune, H., 2161.
 Le Monceau, 157.
 Le Norman, Baron, 145.
 Le Nôtre, 23.
 Le Roy, M., 1363.
 Lechenault de la Tour, M., 307.
 Ledbury, 2371.
 Ledbour, 208.
 Ledlie, Wm., 108.
 Lee, 757.
 Lee, Messrs., 2440.
 Lee and Kennedy, Messrs., 72.
 Lee Court, Kent, 2035.
 Lee Park, 1396.
 Leeds Churchyard, 2092.
 Lees, Mr. Edwin, 367.
 Leigh Court, 956.
 Leigh Park, 659.
 Leinster, Duke of, 1283.
 Leith Walk, 105.
 Leland, 1393.
 Lelius, 1023.
 Lemarrais, 139.
 Lemarrais, Count, 2452.
 Lemon, Sir C., Bart., 1854.
 Lemonnier, M., 1401.
 Lemonnier, Madame, 277.
 Lemonnier of Montreuil, 157.
 Leopold Frederick Francis Dubs
 of Dessau, 149.
 Lepanto, 2039.
 Lepelletier, 1717.
 Leroux, M., 1459.
 Leroux, M. A., 2415.
 Leslie, 2376.
 Leslie, Hon. W., 2431.
 Leslie House, 2040.
 Lesser, 1816.
 Lete, Master Nicholas, 757.
 Lettaom, 393.
 Leucothée, 1113.
 Leven, Earl of, 2120.
 Leven's Grove, 1341.
 Levenside, 89.
 Lewes, 1428.
 Lewin, 1481.
 Lewis, 483.
 Lewis, Governor, 1166.
 Lewis, G. R., 1732.
 Lewis, E. W., 906.
 Lewis, R. H., 906.
 Ley, Mr., 1223.
 Leycester, Lord, 785.
 Leycester, William, 1080.
 Leyden, 143.
 Leyton, 2099.
 L'Héritier, 244.
 Lichfield, 78.
 Lichtenstein, Prince, 148.
 Lichtenstein, Prince, Siagrab, 147.
 Licinius Mucianus, 2038.
 Lightfoot, 27.
 Lima, 2438.
 Limerick, 1428.
 Linaker, Dr., 787.
 Lincoln, 192.
 Lincoln's Inn, New Square, 1690.
 Lindley, Dr., 213. (and 80 other
 places).
 Lindsay, Mr. T. M., 2198.
 Link, 666.
 Lintithgow, Earl of, 82.
 Linnæus, 54. (and 73 other places).
 Linnæus the younger, 1632.
 Lion's Lodge, 1813.
 Lippa, 950.
 Lippold, Dr., 890.
 Lisbon, 170.
 Litchett Park, 1779.
 Little Bee Tor, 1757.
 Little Park, Windsor, 1755.
 Little Shardon, 2001.
 Littlebourne, 1384.
 Littlecote Hall, 1382.
 Livermore, 419.
 Liverpool, 131.
 Livingston, 48.
 Livingston, Mr., 177.
 Llanbede, 430.
 Llanbede Hall, 1227.
 Llandaff, Bishop of, 1987.
 Llandfolist Churchyard, 2071.
 Llanthwy Vach Churchyard,
 2078.
 Lieland, 2079.
 Llewelyn, Dillwyn, 1889.

- Lloyd, the Rev. and Hon. Lumley, 56, 62.
 L'Obel, 35.
 Lobsenz, 1831.
 Loch Arkeg, 1772.
 Loch Holshnie Forest, 2362.
 Loch Leven, 840.
 Loch Lomond, 2091.
 Loch-na-Garr, 2164.
 Loch Ordie Forest, 2362.
 Loch Tay, 768.
 Loch of the Lows, 2360.
 Lochaber, 1772.
 Lochiel House, 997.
 Lochnell, 2080.
 Lochwood, 1771.
 Lockhart of Lee, 100.
 Loddiges, Conrad, 83.
 Loddiges, Messrs., of Hackney, 80. (and 161 other places).
 Loebichan, 148.
 Logan, Albert, 888.
 Logierait, 1226.
 Loiseau Deslongchamps, 189. (and 23 other places).
 Loke, 889.
 London, 4. (and 184 other places).
 London Bridge, 1748.
 London, George, 46.
 London and Wise, 46.
 Londonderry, Marquess of, 575.
 Long, H. L., 2322.
 Longford Tor, 1757.
 Longford Castle, 624.
 Longford, Earl of, 1842.
 Long Island, 616.
 Longleat, 930.
 Longman, T. N., 229.
 Longtown, 1169.
 Lonicer, Adam, 1043.
 Lonicer, John, 1043.
 Loo, 144.
 Los Barrios, 1925.
 Losel's Wood, 1756.
 Lothian, Marquess, 1772.
 Loudon, Baron, 150.
 Loudon Castle, 91.
 Loudon, John Earl of, 101.
 Loudon, Marshal, 150.
 Loudon, James, 1940.
 Loudon's Brae, 2157.
 Lough Lane, Islands of, 108.
 Louis XI., 1351.
 Louis XII., 613.
 Louis XIV., 368.
 Louis XV., 263.
 Louis XVI., 2904.
 Louis XVIII., 1411.
 Louisiana, 2484.
 Louisville, 285.
 Loureiro, 482.
 Louth, 1195.
 Louvre, 1969.
 Lowe of Clapton, 119.
 Low Layton, 771.
 Low Plains, near Penrith, 2384.
 Lowe, Rev. Mr., 812.
 Lower Sketty, 1839.
 Lowhill, 2120.
 Lowndes, Mr., 1826.
 Lowth, 1902.
 Lowther, Lord, 1788.
 Lucan, 1462.
 Lucania, 420.
 Lucky Bay, 958.
 Lucombe, Mr., 1850.
 Lucombe and Pince, Messrs., 1286.
 Lucrè, 46.
 Lucullus, 22.
 Lugdunensis, 2008.
 Lund, 154.
 Luscombe, 275.
 Luscombe, John, 396.
 Luther, 792.
 Luttrellstown, 1323.
 Luxembourg, 465.
 Luxembourg Palace, 750.
 Lyceum at Athens, 2038.
 Lycia, 2038.
 Lycurgus, 1366.
 Lydgate, 696.
 Lyndhurst, 1761.
 Lyne Grove, 712.
 Lyon, 118.
 Lyon, John, 122.
 Lyon, William, 122.
 Lyonet, M., 1819.
 Lyons, 461.
 Lyons, John, 2527.
 Lyons, 43.
 Lyte, Master, 1251.
 Lytton, Lord, 1977.
 M.
 M'Clise, 901.
 M'ulloch, J.R., 316. (and 17 other places).
 M'Gill, Sir John Dalrymple, 2120.
 M'Gregor, Mr., 2116.
 M'Intosh, Mr., 145.
 M'Kie, John, of Larg, 97.
 M'Killigan, Mr., 1149.
 M'Leay, 1388.
 M'Leay, W. S., 2140.
 M'Leish, G., 1217.
 M'Leod, 1226.
 M'Mahon, Mr., Philadelphia, 1363.
 M'Nab, Mr., 99.
 M'Nab, James, 354.
 M'Pherson, 1339.
 M'caire, M., 733.
 M'caire and Marcet, Messrs. 300.
 Macartney, Lord, 304.
 Maccallen, 2576.
 Macculloch, Dr., 100.
 Mackay, T. 97.
 Mackenzie, Mr., 2212.
 Mackie, John, 96.
 Mackree Castle, 291.
 Macleod, Mr., 1978.
 Maclure, Wm., 1362.
 Macquarrie Harbour, 1296.
 Macrostie, Alexander, 2391.
 Maddock, 1763.
 Madiot, M., 1358.
 Madrid, 170.
 Maelough Castle, 290.
 Magdalen College Grove, Oxford, 1403.
 Magnol, 260.
 Mahomet, 792.
 Mahomet II., 172.
 Maia, 1228.
 Maidenhead, 407.
 Maidstone, 622.
 Maillardière, 266.
 Main, J., 251.
 Maitland, 87.
 Majendie, M., 1459.
 Makoy, Jacob, 386.
 Malcolm, 119.
 Malcolm, William, 83.
 Malcolm, Sir John, 792.
 Malebays, 425.
 Maledetta, 2188.
 Malesherbes, 137.
 Mallet, M., 617.
 Mallet, M. de Chilly, Sologne, 2452.
 Mallet, Madame la Baronne, de Coupigny, 143.
 Malmesbury, 139.
 Malone, 106.
 Malpays de la Joya, 2266.
 Malpighius, 61.
 Mamhead, 73.
 Marnhill Churchyard, 2077.
 Mamre, Oak Grove of, 1790.
 Manchester, 130.
 Manetti, G., 168.
 Mangies, Captain, 1931.
 Mangies, Robert, 2328.
 Manila, 1342.
 Manitta, 2048.
 Mannheim, 147.
 Mans, 2216.
 Manwood, 1751.
 Mar, Earl of, 89.
 Mar, Woods of, 2116.
 Maratray, M., 422.
 Marboeuf, 565.
 Marcgraf, 369.
 Margram, 1296.
 Margraves of Baden, 147.
 Marie, Her Imperial Majesty the Empress, 121.
 Marienwerder, 148.
 Marino, 1902.
 Markwick, 1819.
 Marlborough, Caroline Duchess of, 2122.
 Marlborough, Duke of, 2902.
 Marlborough, George, 4th Duke of, 127.
 Marlborough House, 1769.
 Marlee, near Dunkeld, 2022.
 Marmier, M., 264.
 Marneok, Mr., 1103.
 Marquis, 1717.
 Marryatt, Mrs., 965.
 Marseilles, 315.
 Marsh, Henry, 62.
 Marshall, Mr., 627.
 Marshall, R., 1761.
 Marshall, W., 188.
 Marsham, 840.
 Marsham, Robert, 1783.
 Marstoke Castle, 1227.
 Maryas, 2328.
 Martefontaine, 652.
 Martial, 785.
 Martin, 2420.
 Martin, Dr. Samuel, 1159.
 Martin, Mr. Charles, 163.
 Martin, D., 781.
 Martius, 939.
 Martyn, Professor, 302.
 Marullus, 792.
 Marvell, Andrew, 941.
 Mary, Queen, 39.
 Masania, 2349.
 Mason, 1043.
 Massachusetts, 1018.
 Mason, Francis, 83.
 Masters, Mr., 622.
 Matanzas, 121.
 Malaxa, Count Marine, 2227.
 Maton, Dr., 2125.
 Matthew, Mr., 1173.
 Matthews, Mr., 185.
 Matthews, Mr., of Frimley, 2023.
 Mathiolus, 180.
 Maule, 93.
 Maundrell, 2410.
 Maupertuis, 1697.
 Mauritania, 598.
 Mauroceni, Signor Francisco, 504.
 Mausolus, 1098.
 Maxwell, 2079.
 Maxwell, Lady Heron, 96.
 Maxwell, Sir Thomas, 1403.
 May, Dr., 48.
 Mayland, near Antrim, 106.
 Mayne, 840.
 Mayne, Judge, 96.
 Mazanderan, 940.
 Meader, 80.
 Mease, Dr., 181.
 Meason, Gilbert Laing, 1665.
 Meath, Earl of, 114.
 Meaux, 1579.
 Mecklenburg, 153.
 Medicus, M. F. C., 617.
 Médoc, 2221.
 Melbourne Hall, 290. (and 36 other places).
 Melbury Park, 430.
 Melie, 1725.

Melitus, 2038.
 Melius, 899.
 Mellerstane, Berwickshire, 91.
 Melville Castle, 1481.
 Melville, Lord, 1809.
 Memel, 2113.
 Mency, 2157.
 Menelaus, 2037.
 Mentath, J. S., 2172. 2177.
 Menteth, Lake of, 90.
 Menzies, Archibald, 118.
 Menzies, Mr., of Migenny, 2359.
 Mérat, M., 2414.
 Mercury, 1723.
 Mereville, 158. 291.
 Merivale, 1841.
 Merlet de la Boulaye, 263.
 Merlin, M., 2037.
 Mersham Hatch, 2282.
 Mertens, Professor, 153.
 Mertens, 1485.
 Merton, 1840.
 Merton Hall, 1840.
 Merton Park, 371.
 Mesopotamia, 1721.
 Methel, 2370.
 Methven Castle, 2120.
 Metz, 138.
 Meulemeester, M., 2013.
 Miasco, 2462.
 Michael Angelo, 2471.
 Michaux, André, 84. (and 196 other places).
 Michaux, F. A., 142.
 Michell, 1832.
 Michendon House, 1763.
 Mickleham, 1682.
 Middleton, Lord Viscount, 2403.
 Middleton, Mr., 2504.
 Midstrath, 1226.
 Milan, 785.
 Mildenhall, 2326.
 Mile End, 2086.
 Milford, 151.
 Mill Hill, 1733.
 Miller, P., 38. (and 105 other places).
 Milne, Alex., 1800.
 Milne, Dr. Colin., 77.
 Milne, John, 2575.
 Milo of Croton, 1720.
 Miltiades, King of the Dolonei, 2112.
 Milton, 962.
 Milton House, 1527.
 Milton Park, 1953.
 Minard, 327.
 Minerva, 791.
 Mingrelia, 14. 0.
 Minster, 1576.
 Minto, 184.
 Minuart, 312.
 Minward, 719.
 Mirbel, Professor, 135.
 Misenus, 2472.
 Missa, 369.
 Mitcham, 63. 1415.
 Mitcham Manor House, 1367.
 Mitchell, Dr., 40.
 Mitchell, Judge, 624.
 Mitchell, Mr., 1223.
 Mitchelstown, 107.
 Mitford, Rev. J., 2426.
 Mithridates, 625.
 Mittau, 410.
 Moccas Court, 1227. 1732. 1811. 1840.
 Moccas Park, 1762.
 Mönch, 1395.
 Mogador, 1052.
 Moira, 108.
 Molagnore, 163.
 Molina, 2436.
 Molyneux, 1822.
 Monarda, 2512.
 Monardes, 1302.
 Monbodo, 1227.

Monceau, 139.
 Monck, Sir Charles, 2120.
 Monckton, General, 815.
 Monckton, Major-General, 2562.
 Mongewell, near Wallingford, 1380.
 Monro, Dr. 596.
 Mons, 1843.
 Mont Blanc, 2110.
 Mont Perdu, 2110.
 Montague, Lady Elizabeth, 1782.
 Montanvert, 2276.
 Montargis, 265.
 Monte Rey, 2268.
 Monteith, 1797.
 Monteith, Mr., 89.
 Montelimart, 1351.
 Monterey, 2249.
 Montgomery, 1463.
 Montmorency, 693.
 Montpellier, 140.
 Montreal, 182.
 Montreuil, 137.
 Montrose, 570.
 Monza, 168. (and 63 other places).
 Monzie, 2355.
 Moor Park, 23.
 Moorcroft, Mr., 946.
 Moore, 677.
 Moore, Captain, of Eglantine, 1229.
 Moore, Mr., 81.
 Moran, 363. 1947.
 Moray, Earl of, 1225.
 Mordant de Launay, 2304.
 Morden, 1427.
 Moreudun Park, 419.
 Morel, 188.
 Morgan, Edward, 50.
 Morgan, Hugh, 37.
 Morges, 372.
 Morier, 1661.
 Morison, 2226.
 Moritaburg, 2364.
 Morley, 1756.
 Morley, Earl of, 1757.
 Morn Park, 1119.
 Morpeth, 1006.
 Morrison, 50.
 Mortimer, 613.
 Mortlake, 1480.
 Morton, Earl of, 101.
 Morton Hall, 1748.
 Morton, Lord, 1226.
 Moschus, 2040.
 Moscow, 158. 287.
 Moseley, Sir Oswald, 2254. 2254.
 Moses, 677.
 Moss, Mr., 1831. 2571.
 Mosul, 661.
 Mout, the, 484.
 Mount Amanus, 2407.
 Mount Antisana, 983.
 Mount Anville, 2406.
 Mount, Anville Hill, 114.
 Mount Asher, 1905.
 Mount Athos, 1647.
 Mount Atlas, 548.
 Mount Aventinus, 1643.
 Mount Baldo, 1139.
 Mount Cashel, Earl of, 1841.
 Mount Cassiano, 577.
 Mount Cassius, 1213.
 Mount Cenis, 2188.
 Mount Domoglet, 1809.
 Mount Edgcombe, 73.
 Mount Edgcombe, Earl of, 73.
 Mount Elwend, 813.
 Mount Enos, 2326.
 Mount Ensiendog, 1586.
 Mount Etna, 582.
 Mount Grove, 229.
 Mount Gurval, 1052.
 Mount Helicon, 1190.
 Mount Ida, 1016.
 Mount Janiculum, 1695.
 Mount Jorullo, 983.
 Mount Juliet, 1394.
 Mount Lebanon, 702.
 Mount Lycæus, 1720.
 Mount Norris, Earl of, 250.
 Mount Olympus, 1120.
 Mount Orizaba, 1156.
 Mount Pilate, 1156.
 Mount Schibel Jaekel, 1252.
 Mount Shannon, 1979.
 Mount Shespur, 3031.
 Mount Silla de Caracac, 1164.
 Mount Sinal, 947.
 Mount Sion, 2466.
 Mount Stuart, 101.
 Mount Tanga, 2527.
 Mount Taurus, 2407.
 Mount Trara, 1052.
 Mount Ventoux, 2188.
 Mount Vesuvius, 636.
 Mount Wellington, 2567.
 Mount Zoccolaro, 1987.
 Mounre Mountain, 110.
 Mousseure, 1023.
 Mozzate, 169.
 Murross Abbey, 1113.
 Muddiford, 2234.
 Muddick, 2186.
 Mühlberg, 1876.
 Mühlberg, Dr., 1236.
 Muirland Hills, 1939.
 Mulhausen, 140.
 Munby, Giles, 1225.
 Munches, 1733.
 Munich, 151.
 Munro, Mr., 124.
 Munro, James, 801.
 Munster, 1828.
 Murat, M., 2405.
 Murchison, Mr., Murdoch, 1894.
 Murphy, Mr., 108.
 Murray, Mr., 1667.
 Murray, W., 2378.
 Murray, Stewart, 2446.
 Murray, Mungo, 1217.
 Murray, Patrick, 48.
 Murray, Regent, 832.
 Museum of Natural History, Paris, 2228.
 Muskau, Prince Pückler, 151.
 Musenbrach, 2417.
 Murwell Hill, 1322. (and 19 other places).
 Mutia, 1167.
 Mylor Bridge, 2216.
 Myrsine, 961.
 Myrtila, 962.

N.

Nagasaki, 1336.
 Nagurunger, 2430.
 Namedy, 2114.
 Naundu Park, 1763.
 Nantes, 138.
 Nantwich, 39.
 Napier, Major-Gen. C. Jaz., 2265.
 Naples, 296.
 Naples, King of, 890.
 Napoleon, 2327.
 Napoleon, tomb of, 1503.
 Narainhetty, 714.
 Narbonne, 645.
 Nash, Dr., 326.
 Nasmyth, Sir James, 93.
 Nasmyth, Sir John Murray, Bart., 463.
 Nassau, 1842.
 Nasus, Procopius, 699.
 Naumachia, Tiberius Cæsar's, 2357.
 Nebel, M., 2157.
 Nebel and Neunreutter, 2157.
 Nee, Louie, 1948.
 Needham's Villa, 407.
 Needwood Forest, 509.
 Nees von Esenbeck, 1826.
 Neill, Patrick, 544.
 Neptune, 1105.

- Nero, 2557.
 Nerrère, M., 138.
 Nerrères, 466.
 Nasfield, W. A., 2161.
 Nether Place, 2067.
 Netley, 2140.
 Netticcombe, 466.
 Neufchâteau, M. François de, 615.
 Neuilly, 139.
 Neustadt, 973.
 Neustadt-an-der-Linden, 372.
 Neustra Señora del Pino, 2863.
 Nevin, Mr., 2121.
 New Forest, 509.
 New Hailes, 91.
 New London, 183.
 New Palace, Pimlico, 2422.
 New Place, Stratford, 1345.
 New Posso, 93.
 New Providence, 141.
 New York, 10.
 Newark, 2185.
 Newbattle, 89.
 Newbattle Abbey, 419.
 Newbury, 1778.
 Newcasle, 192.
 Newcastle, America, 2139.
 Newdigate, Serjeant, 49.
 Newington, 1762.
 Newington Butts, 2087.
 Newman, 907.
 Newman, W., 73.
 Newnham Courtney, 1776.
 Newnham Faddocks, 1303.
 Newport, 1778.
 Newport, Shropshire, 2334.
 Newton, 1651.
 Newton Abbot, 360.
 Newton Barry, 106.
 Newton Lane, 1783.
 Newton Mount Kennedy, 107.
 Newton, Stewart, 96.
 Nicander, 2069.
 Nice, 587.
 Nichols, T., 1787.
 Nicholf, John, 1507.
 Nicol, 1219.
 Nicol, Walter, 188.
 Nicolaï, 1737.
 Nicolson, Sir Thomas, 2825.
 Niddry Marischall, 419.
 Nieuport, 2319.
 Nigel, 1756.
 Nikita, 159.
 Nineveh, Gardens of, 2423.
 Nisbet, 419.
 Nisbett, Captain, 391.
 Nismes, 546.
 Niven, N., 114.
 Noailles, Maréchal de, 178.
 Nocton, 466.
 Noisette, M., 139.
 Nonsuch, 1210.
 Nonsuch Palace, 35.
 Nonsuch Park, 360.
 Nootka Sound, 1069.
 Norbury, 1775.
 Norbury Park, 1682.
 Norfolk, 1044.
 Norfolk, Earl of, 50.
 Norfolk, Duke of, 45.
 Normanton Park, 1840.
 Noronha, 2055.
 Norridgewock, 2282.
 Norris, Rev. Mr., 1377.
 North Barr, 1670.
 North Molton, 1757.
 Northiam, 1770.
 Northampton, Marquess of, 1764.
 Northumberland, Duke of, 2158.
 Northumberland, Henry Earl of, 73.
 Northumberland, Hugh Duke of, 82.
 Norton House, 2001.
 Norton, Sir John, 1751.
 Norwich, 192.
 Norwood, 1736.
 Nostizza, 2042.
 Nourmahal, Princess, 785.
 Numa, 2409.
 Numa Pompilius, 1695.
 Nunwell Park, 1762.
 Nuremberg, 190.
 Nurse of Bealings, 1652.
 Nurseries:—
 Adam's, M., Paris, 590.
 Allen and Rogers's, Battersea, 1060.
 Anderson and Lealie's, Messrs., 105.
 Arcuell, 373.
 Audibert's Messrs., 2465.
 Audibert's, of Tarascan, 140.
 Austen's, Messrs., Glasgow, 105.
 Backhouse's, Messrs., York, 2525.
 Bassington's, Kingsland, 79.
 Baumann's, Messrs., Bollwyler, 140.
 Booth's, Messrs., Hamburg, 158.
 Boucher's, Comely Bank, 106.
 Brenchley, 749.
 Brentford, 232.
 Brighton, near Boston, 1327.
 Bristol, 330.
 Brompton, 272.
 Brompton Park, 46.
 Brown's, Slough, 281.
 Buchanan's, 541.
 Busch's, John, Hackney, 79.
 Camberwell, 832.
 Canterbury, 1404.
 Catros's, M., Bordeaux, 469.
 Cels's, 140.
 Chester, 2479.
 Clapton, 350.
 Clonmel, 491.
 Cobbett's, 617.
 Coivill's, 240.
 Cormack's, New Cross, 79.
 Cree's, J., Addleston, 967.
 Cullenswood, 266.
 Cunningham's, Messrs., Edinburgh, 2452.
 Daillodouse, Messrs., near Geneva, 161.
 Dalroy, 369.
 Daniell's, M., on the Boulevard Mont Farnasse, 2431.
 Darby's, Hoxton, 46.
 Dennis's, Chelsea, 984.
 Dickson and Co's., Messrs., 102.
 Dickson and Shankley's, 105.
 Dickson and Turnbull's, Messrs., Perth, 105.
 Dickson's, Messrs., Chester, 2452.
 Dickson's, Mr., at Hassendeanburn, 105.
 Dickson's, Walter, 105.
 Donald's, Goldworth, 1282.
 Dunganstown, 2475.
 Epsom, 310.
 Exeter, 1855.
 Exotic, King's Road, Chelsea, 119.
 Fairchild's, Hoxton, 76.
 Fennessey and Son's, Messrs., 1735.
 Flåtbeck, 885.
 Fountain Bridge, 885.
 French Authorities, 178.
 Fulham, 7.
 Furber's, Kensington, 76.
 Gibbs's, 1435.
 Godefroy's, 146.
 Goldworth, 273.
 Gordon's, Jas. and Wm., 78.
 Gordon, J., T. Dermer, and A. Thompson's, 78.
 Gordon's, Fountainbridge, 105.
 Gordon's, Mile End, 76.
 Gray's, Fulham, 76.
 Gray and Wear's, 47.
 Nurseries — continued.
 Grigor's, Mr., Forres, 2186.
 Hackney, 79. (and many other places).
 Hammermith, Lee's, 252. (and 56 other places).
 Handsworth, 491.
 Hasendeanburn, 1658.
 Hawick, 1640.
 Haven's, M., Erfurt, 153.
 Held's, Vienna, 150.
 Higgins's, Mr., Tipperary, 1228.
 Hodgins's, near Wicklow, 116.
 Hodgkin's, Dunganston, 2121.
 Holloway Down, 1922.
 Humbeque, 817.
 Hunt's, Putney, 55.
 Huntingdon, 1404.
 Irving's, 1733.
 Jaquemot-Bonneford, Ammouy, 140.
 Jeffries's, 47.
 Jeffries and Gray's, 47.
 Kensington, 280.
 Killenny, 491.
 Killerton, 289.
 Kinnoul, 2327.
 Knaphill, 277.
 Knight's (Exotic) 235.
 Landreth's, 1385.
 Lawson's, Edinburgh, 475.
 Le Candele, M., Humbeque, 145.
 Lee and Kennedy's, 76.
 Leslie, Thomas, and Co's., Dundee, 105.
 Lewisham, 539.
 Leyton, 383.
 Loddiges's, Messrs, 76. (and numerous other places).
 London and Wise's, 46.
 Low's, 305.
 M' Mahon's, 1363.
 Mackay's, Norwich, 625.
 Malcolm's, 76.
 Malcolm and Co's., Messrs. Wm., 77.
 Mansfield, 749.
 Marsfield, 1081.
 Marylebone, 1205.
 Mathieu's, M., Berlin, 153.
 Millbank, 80.
 Mile End, 257. (and 35 other places).
 Milford, 588.
 Mossures (India), 894.
 Nerrères, M., Nantes, 565.
 Nerrin, M., Nantes, 516.
 New Cross, 1217.
 Noisette's, 140.
 Norbiton Common, 1147.
 Norwich, 663.
 Ogle's Grove, 1229.
 Parmentier's, M., Enghien, 145.
 Perth, 270.
 Pontey's, Plymouth, 964.
 Pope's, Messrs., 625.
 Prince's, 815.
 Reid's, Aberdeen, 105.
 Ricketts and Pearson's, 46.
 Richmond's, Mr., 102.
 Rins, M., Frankfort, 153.
 Rivers and Son's, Messrs., Sawbridgeworth, 779.
 Robertson's, Kilkenny, 116.
 Roehampton, 339.
 Rollison's, Messrs., Tooting, 938.
 Ronald's, Brentford, 79.
 Rosenthal's, Vienna, 150.
 Roy's, M., Angers, 2536.
 Roy's, Aberdeen, 2121.
 Russell's, Lewisham, 76.
 Sampson's, Kilmarnock, 105.
 Saunders's, Jersey, 290.
 Sawbridgeworth, 1923.
 Schelhaus's, M., Cassel, 153.
 Sedy's, Lyons, 1432.
 Seidel, M., Dresden, 153.

Nurseries—*continued.*

Shank Hill, 115.
 Soane Street, 1149.
 Smith and Co's., 47.
 Smith's, G., 1314.
 Smith's, Worcester, 1405.
 Soulange-Bodin's, M., 2432.
 St. Peter's, 1670.
 Swinhoe's, 47.
 Thompson's, Jamea, 78.
 Thompson's, Mr., Mile End, 7.
 Toole and Co's., near Dublin, 115.
 Tooting, 387.
 Upway, 567.
 Urquhart's, Dundee, 667.
 Vauxhall, 582.
 Veitch's, Exeter, 466.
 Vilmorin, M., 2432.
 Vitor, 678.
 Walton, 1073.
 Waterer's, Mr., Knaphill, 2493.
 Whitley and Osborne's, Fulham, 76.
 Wilkins's, Isle of Wight, 419.
 Wilson's, Messrs., Derby, 1228.
 Young's, 306.
 Nutfield, 2460.
 Nutfield Bletchingley, 1861.
 Nuttall, T., 122.
 Nymphenburg, 151.
 Nyssa, 1005.

O.

Oak of Honour Wood, 1818.
 Oak Park, 1841.
 Oakes, O. R., 1651.
 Oake, Sir Henry T., 145.
 Oakfield, 1747.
 Oakham, 290.
 Oakingham, 1747.
 Oakley Farm, 1779.
 Oaksey, 1747.
 Oatlands, 71.
 Ochills, 1797.
 Ochertyre, 1224.
 Ociula, Woods of, 1948.
 Ockham Court, 619.
 Ockham Park, 2022.
 Odessa, 373.
 Oehlberg, 1509.
 Enone, 1643.
 Ofa, King of Mercia, 1353.
 Oglander, Sir W., 1762.
 Ohio, 2048.
 Ohr, 152.
 Okey, 1747.
 Old, or Wold, 1747.
 Old Baseford, 888.
 Old Brompton, 71.
 Old Court, 2231.
 Old Montrose, 716.
 Old Orchard Ground, Boddington
 Manor Farm, 1780.
 Old Palace Yard, Westminster, 613.
 Old Street, 882.
 Oldenham, 1881.
 Oldys, 1391.
 Oliver, 547.
 Oliver Cromwell, 2426.
 Olivier, 172.
 Olivier de Serres, 689.
 Olmuts, 686.
 Ombersley, 371.
 O'Neill, Earl, 1842.
 Opois, M., 789.
 Orange Grove, 111.
 Oratava, in the Grand Canary
 Island, 2263.
 Ord, Craven, Esq., 1391.
 Ord, John, 72. 84.
 Orford Hall, 2182.
 Orford, Lord, 2328.
 Oriel, Lord, 108.
 Oriel Temple, 269. (and 38 other
 places).

Oriens, 1969.
 Oriens, Duke of, 139.
 Orme's Head, 870.
 Ormiston Hall, East Lothian, 89.
 Orpheus, 1582.
 Ortega, 2064.
 Osborne, Mr., Junr., 849.
 Osborne, Messrs., 1851.
 Osbourne, Wm., 2161.
 Osorno, 2436.
 Oswestry, 1768.
 Ostorius, 1721.
 Otto, F., 190.
 Otto, M., 151.
 Otto von Münchhausen, Baron, 148.
 Ouseley, Sir Gore, 2318.
 Ouseley, Sir Wm., 786.
 Ovenside, 1641.
 Ovid, 941.
 Owen Glendower, 1763.
 Oxenford, 89.
 Oxenford Castle, 2120.
 Oxford, 53.
 Oxley, Mr., 2443.

P.

Pachuca, 1160.
 Padua, 169.
 Pagoda Siri, 792.
 Pains Hill, 70. (and 26 other
 places).
 Pakenham, 1327.
 Pakenham Hall, 270.
 Palace Pitti, 1260.
 Palestine Hill, 1016.
 Palazzo del N. H. Venier, 1337.
 Palermo, 1022.
 Pallas, 83. (and 133 other places).
 Palmer, A., 619.
 Palmer, Daniel, 622.
 Palmer, T. C., 385.
 Pan, 1958.
 Pan's Theatre, 2013.
 Pan-Schan, 1936.
 Panoras, Earl of, 2086.
 Panmure, 89.
 Panshanger, 1782.
 Pantycored, near Brecon, 1839.
 Panzer, 1824.
 Paphos, 1930.
 Pappenheim, Baron, 139.
 Parham Park, 895.
 Paris, 10. (and 92 other places).
 Pariset, Dr., 2417.
 Pariset, M., 2411.
 Park Place, near Henley, 1981.
 Parker, Mr., 56.
 Parkinson, 25. (and 42 other
 places).
 Parks, 771.
 Parmentier, M., 279.
 Parson's Green, 227.
 Parsons, Mr. Thomas, 2413.
 Pascoe Estate, 1840.
 Paul, His Imperial Majesty the
 Emperor, 121.
 Pauli Simon, 2067.
 Paulus Jovius, 1747.
 Pausanias, 1016.
 Pavia, 1661.
 Pavon, Don Joseph, 2436.
 Paw, Peters, 469.
 Paxton, J., 1286.
 Payne, Messrs., 622.
 Peak of Teneriffe, 2552.
 Pearson, John, 1735.
 Pease, J., 1839.
 Pecinardi, 169.
 Peck, 618.
 Peckham, 54.
 Peebles, 466.
 Pekin, 304.
 Pelagius, 1720.
 Pembroke and Montgomery, Earl
 of, 60.
 Pembroke College, Oxford, 1347.

Pendarves, 654.
 Pendarves, E., 664.
 Penelope, 1654.
 Penes, 1294.
 Penllygar, 1637.
 Penn, 2547.
 Penn, William, 85.
 Pennam, 91.
 Penny, Mr., 2328.
 Pennicuick, Dr., 93.
 Pennycuick, 1103.
 Penshurst, 772.
 Pentland Hills, 575.
 Penzance, 136.
 Pépinière de Luxembourg, 815.
 Pépinière du Roale, 1927.
 Pepper Harrow Park, 515.
 Pera, 2467.
 Percival, Dr., 2083.
 Père la Chaise, 1665.
 Périgoux, 1227.
 Perkins, F., 2120.
 Permetz, Don, 1194.
 Péronet, M., 2029.
 Perrotet, M., 1348.
 Perry, John, 1331.
 Perseus, 1105.
 Perusia, 2418.
 Perseus, 688.
 Perth, 132.
 Pezth, 150.
 Pezquier, M., 2008.
 Peter the Great, 45.
 Peterborough, Lord, 267.
 Peters, J. B., 2219.
 Petersburg, 120.
 Peterzen, Jens P., 154.
 Pétigny, M., 2026.
 Petit Trianon, 1879.
 Petre, Lord, 55.
 Petworth, 1341.
 Peyrou, M., 1255.
 Peyssonet, M., 2054.
 Pfaucen Inse, 419.
 Phaethon, 1654.
 Philadelphia, 184. (and 30 other
 places).
 Philemon, 1724.
 Philip II., 2050.
 Philip, Infant of Spain, 2672.
 Philippi, 784.
 Philippi, Dr., R. A., 1351.
 Philippi, 623.
 Philippe, Henry, 128.
 Philipburgh, 2136.
 Phillips, 901.
 Philosopher, Geneva, 163.
 Philya, 1203.
 Phrygia, 1724.
 Phyllis, 678.
 Phyllococe, 1115.
 Piedmont, 884.
 Piersbridge, 980.
 Pierson, Rev. Archdeacon, 154.
 Pigoot, 74.
 Pikhov, 728.
 Pickley, 1766.
 Pinanura, 1068.
 Pince, Mr., 1252.
 Pintoe, 1168.
 Pirolo, M., 1225.
 Pitalon, Dr., 83.
 Pithiviers, 2415.
 Pitt, Mr., 1831.
 Pittwiers, 1878.
 Pittsburg, 184.
 Pitya, 2121.
 Planer, 1409.
 Plantagenet, Richard, Duke of
 York, 793.
 Plat, Sir Hugh, 36.
 Plato, 2038.
 Pleasant Row, Peatonville, 1228.
 Plessis, 2000.
 Pliny, 50. (and 103 other places).
 Pliny's Tusculan Villa, 1334.
 Plot, Dr., 1821.

- Pluche, 9051.
 Plukenet, 41.
 Plummer, 1300.
 Plumstead, 895.
 Plutarch, 675.
 Pluto, 941.
 Plymouth, 570.
 Pockocke, Dr., 201.
 Podenas, 1411.
 Podolla, 1494.
 Pöppig, Dr., 9436.
 Pointer, Master Richard, 882.
 Poiret, 1420.
 Poiteau, M., 474.
 Pole, 187.
 Pole, Cardinal, 1344.
 Polhill, J., 1393.
 Polkemet, House of, 2337.
 Pollock, 1403.
 Polonger, M., 1931.
 Polydore, 1015.
 Polydore Virgil, 1750.
 Polydorus, 962.
 Polyphemus, 2121.
 Pomet, 798.
 Pomona, 791.
 Pompeii, 9228.
 Pompey, 1351.
 Ponsoby Hall, 414.
 Pontefract, 754.
 Pontey, 1525.
 Pontey, William, 188.
 Pontus, 1131.
 Poole, Mrs., 389.
 Pope, 54.
 Pope and Co., Messrs., 2548.
 Pope Eugene, 2467.
 Pope's Villa, Twickenham, 1237.
 Poppiladorf, 1228.
 Porcel, Antonio, 293.
 Porcella, 2555.
 Porkington, 1840.
 Porragund, 2322.
 Port de la Pes, 2208.
 Port Elliot, 289.
 Port Famine, 943.
 Port Jackson, 960.
 Portarlington, Earl of, 2184.
 Portbridge, in Dartford, 24.
 Portbury Churchyard, 2081.
 Portenschlag, 743.
 Porter, Sir Robert Ker, 2039.
 Porteus, Bishop, 44.
 Portillo de la Villa, 2263.
 Portland, Duchess of, 83.
 Portland, Duke of, 1699.
 Portland's Park, Duke of, 1766.
 Portsmouth, 1750.
 Portsmouth, New Hants, 1445.
 Portsmouth Road, Surrey, 575.
 Portway House, 1784.
 Posen, 1831.
 Posso, 2120.
 Potemkin, Prince, 159.
 Potts, Mr. John, 391.
 Pouqueville, 175.
 Powderham Castle, 73.
 Power's Court, 1119.
 Powerscourt, 107.
 Powis Castle, 1840.
 Powis, Earl of, Ludlow, 1840.
 Powis, Earl of, 2523.
 Pownall, Governor, 615.
 Poynter, Richard, 35.
 Prado Park, Madrid, 1907.
 Prê l'Évêque, 163.
 Prescott, Mr., 2246.
 Press, Mr., 386.
 Preston Hall, 419.
 Preston, Sir Robert, Bart., 123.
 Prestonfield, 90.
 Prévost, Alexandre, 163.
 Priam, 1108.
 Price, Sir Uvedale, 200.
 Priene, 1720.
 Primmct, Mrs., 83.
 Prince, of New York, 181.
 Prinsep, M. Macalra, 2418.
 Prius, Prince of Dahlburg, 148.
 Prior, 2363.
 Prior of Woburn, the, 1753.
 Promenade at Breslow, 151.
 Promenade at the Isle of Barques, 163.
 Fronville, 749.
 Proserpine, 941.
 Protestant Dissenters' School, Mill Hill, 1736.
 Proteus, 1487.
 Providence, 2324.
 Ptolemy Philopater, 1005.
 Puck, 901.
 Puget's Sound, 1059.
 Pugh, Dr. Owen, 2071.
 Pulteney, 39.
 Purkes, 1761.
 Purser's Cross, 72. (and 38 other places).
 Purnh, 122. (and 35 other places).
 Puvia, M. 2121.
 Pyramus, 1344.
- Q.
- Quatorze, Louis, 1337.
 Quebec, 142, 982.
 Queen Adelaide's Lodge, 1755.
 Queen Anne, 80.
 Queen Anne of Austria, 942.
 Queen Caroline, 1675.
 Queen Charlotte's Foreland, 2442.
 Queen Elizabeth, 24.
 Queen Mary, 786.
 Queen Philippa, 1748.
 Queensberry, Duke of, 92.
 Queenwood, Tytherly, Wilts, 2075.
 Queenby Hall, 2413.
 Quendon, 772.
 Quillay-Leuvu, 2437.
 Quirapon, 1948.
- R.
- Racine, 2416.
 Radcliffe, Miss, of Worcester, 2406.
 Raddon, William, 2140.
 Radnor, Earl of, 682.
 Radnor, Lord, 621.
 Radzivil, Prince, 2113.
 Raffeneau de Lile, M., 1364.
 Rafinesque, 477.
 Ragland Castle, 1392.
 Ragley Park, 1833.
 Ragnal, 1849.
 Rañaw-Chabot, Princess of, 953.
 Raith, 716.
 Raith House, 1905.
 Rajah Shah, 2430.
 Raleigh, Sir Walter, 36.
 Rama, 2510.
 Rambouillet, 158.
 Rankellor, Lord, 103.
 Rannoch Forest, 2169.
 Raphael, 2365.
 Rapa, 1991.
 Rappin, Nicholas, 941.
 Rastadt, 2157.
 Ratzburg, Dr., 2141.
 Rauch, Charles, 150.
 Rauch, Francis, 150.
 Rauch, Stephen, 150.
 Rauwolf, 2409.
 Ravenna, 785.
 Ravensworth Castle, 1839.
 Ravensworth, Lord, 73.
 Rawdon, Sir Arthur, 49.
 Rawes, Captain, 385.
 Ray, 25. (and 40 other places).
 Raywood, 1394.
 Razies Bottom, 1760.
 Res, John, 50.
 Reading, 1459.
 Real del Monte, 1013.
 Réaumur, 811.
 Recht, 1411.
 Redleaf, 363.
 Redouté, 189.
 Redruth, 997.
 Reeves, Mr., 177.
 Reeves, Messrs., 2217.
 Regent's Park, 1777.
 Reichenberg, M., 2316.
 Reid, John, 104.
 Reid, Mr., 87.
 Reinhardt, Professor, 1943.
 Remus, 1366.
 Rench, Mr., 55.
 Rennweg, 150.
 Repton, 1004.
 Requien 546.
 Restalrig, 888.
 Retzius, 153.
 Reynardson, of Hillingdon, 56.
 Reynardson, S., 59.
 Reynloit, 2165.
 Reynolds, Sir Joshua, 200.
 Rheede, 527.
 Rhodante, Queen of Corinth, 1810, Bridge of, 1690.
 Ribbesford, 1782, 2082.
 Ribston Park, 895.
 Riccarton, 59.
 Riccioli, 2040.
 Rich, Robert, 692.
 Richard, Achille, 2008.
 Richard Cour de Lion, 2070.
 Richard, Mr., 83.
 Richard II., 2070.
 Richardson, Dr., 124.
 Richardson, Mr., 1860.
 Richelieu, Duke of, 159.
 Richmond, 37.
 Richmond, Duke of, 54.
 Richmond Park, 1822.
 Rickett, 1783.
 Rickmansworth Vicarage, 2543.
 Ricot Park, 832.
 Riga, 2113.
 Rigby, Mr., 1523.
 Rigot, M., Varenbe, Geneva, 1.
 Rimfield Lodge, 1787.
 Ringerike, 2300.
 Ring, M., 153.
 Ring, M. J., jun., 386.
 Rio de Janeiro, 123.
 Rio de la Trinidad, 1062.
 Ripley Castle, 250.
 Rippon, 2073.
 Risco, M., 2214.
 Ritter, M., 147.
 Rivelin, 1778.
 Rivers and Son, Messrs., 750.
 Robert, M. G., 2228.
 Roberts, Mr., 1020.
 Robertson, Mr., 1129.
 Robin, 136.
 Robin, Jean, 609.
 Robin, Vespasian, 136.
 Robinson, Bishop, 42.
 Robinson, Sir George, 1227.
 Robiquet, M., 1931.
 Robson, 2777.
 Rocca dello Capre, 1901.
 Rochester Castle, 309.
 Rochford, Earl of, 82.
 Rock Forest, 747.
 Rockingham Forest, 1833.
 Rockingham, Marquess of, 83.
 Roden, Earl of, 108.
 Roebuck Tavern, Richmond Hill, 1511.
 Roemer, 1048.
 Rofenblad, M., 155.
 Roger, King of Sicily, 1351.
 Rogers, 2027.
 Rogers of Southampton, 761.
 Rogers, Professor, 552.
 Rois, 264.
 Roland, M., sen., 624.
 Rolleston Hall, 931.
 Rollisson, Messrs., 387.
 Rome, 511.
 Romney, 908.

Romulus, 1016.
 Romulus Quirinus, 963.
 Ronard, 785.
 Rooke, Major Hayman, 1766.
 Rook's Nest, 254.
 Rootsey, Mr., of Bristol, 2071.
 Rose, 46.
 Roembourg, 789.
 Rosenberg, 154.
 Roseneath Castle, 290.
 Rosenstein Palace, 152.
 Rosenthal, M., 1737.
 Rosier, 577.
 Rosier Abbé, 685.
 Rossmasser, 2141.
 Rostillon, 107.
 Rotherwas, 1394.
 Rothiemurchus, 2116.
 Rothsay, 2042.
 Rotterdam, 450.
 Rotten, 1212.
 Rouse, 1912.
 Rough Island, 106.
 Round Stone, 1083.
 Rouseau, 1255.
 Roveredo, 1352.
 Roxburgh, 1324.
 Roy, M., 2182.
 Royal Forests, 1750.
 Royal Forest, Chopwell, 1808.
 Royal Naval College, 618.
 Royle, Mr., 173. (and 54 other places).
 Royle, Dr., 245.
 Roselle (Scotland), 716.
 Rubia, 420.
 Rudets, 157.
 Rue de Buffon, 461.
 Rue des Vignes, 565.
 Rue Grenelle, 660.
 Ruellius, 2008.
 Rugby, 841.
 Ruinard de Brimour, Rheims, 2452.
 Ruiz, 293.
 Ruiz, Don Hippolito, 2486.
 Rumbling Bridge, 1217.
 Rumphius, 527.
 Runnymede, 2076.
 Rupp, M., 2115.
 Rush, Dr., of Aleppo, 412.
 Russell, Dr., 72.
 Russell House, Bloomsbury, 613.
 Russell, Lord G. W., 1583.
 Russell, Mr., of Battersea, 1135.
 Rutger, T., 1104.
 Rutter, 465.
 Ryall, 69.
 Rycote, 1775.
 Rydal, 1831.
 Ryton Wood, 1780.

S.

Sabine, Joseph, 123.
 Sacconex, 161.
 Saddle Hill, 2241.
 Saffron Walden, 1760.
 Sageret, M., 541.
 Saguntum, 2408.
 Saint Hilaire, Jaume, 464.
 Saint Suzanne, 2272.
 Sakhehé, 2406.
 Saladin, 785.
 Salamanca, 1905.
 Salcey Forest, 1764.
 Salcombe, 396.
 Salency, 792.
 Salisbury, Lord Treasurer, 40.
 Salisbury, R. A., 56.
 Salisbury, William, 75.
 Salmon, Mr., 2134.
 Salmon, Rev. W. T., 1812.
 Salterbridge, 1979.
 Saltram, 268.
 Saltwood Castle, 1225.
 Salvator Rosa, 1997.
 Salvin, A., 2034.
 Samnerstown, 1916.

Sampayo, T., 57.
 San Antonio, 2251.
 San Luis, 2270.
 San Pedro, 766.
 Sancere, 2000.
 Sanchie, 419.
 Sancho Panza, 1719.
 Sandown Place, 266.
 Sandwell Park, 716.
 Sandwich, Earl of, 251.
 Sang, 89. (and 42 other places).
 Santa Maria de Tula, 2485.
 Santa Rosa, 1944.
 Sarrasin, 999.
 Sarimi, 901.
 Saunders, George, 2182.
 Saunders, B., 1432.
 Saunders, R., 2328.
 Savannah, 2533.
 Savernake Forest, 1792.
 Savi, M., 1253.
 Savoy Palace, 1748.
 Sawbridgeworth, 757.
 Saxe Weimar, Chas. Aug., Grand Duke of, 2061.
 Saxmundham, 958.
 Sexy, Poet John, 2076.
 Say's Court, Deptford, 45.
 Scamozzi, 2012.
 Scarborough, Lord, 1967.
 Scarsdale, Lord, 1839.
 Scéaux, 139. (and 23 other places).
 Schaeffer, 2147.
 Schalouse, 2539.
 Schammes, M., 1844.
 Schawboe, Mr., 2463.
 Schiede and Depppe, 2266.
 Schlegel, 792.
 Schleichner, 118.
 Schmidt, 189.
 Schober, 566.
 Schoch, M., 149.
 Schönbrunn, 148.
 Schönhoff, 150.
 Schoots, Father, 2070.
 Schöttel, 2157.
 Schouw, Professor, 154.
 Schrader, 677.
 Schubert, M., 159.
 Schultes, 1043.
 Schwartzenberg, 150.
 Schwetzingen, 147.
 Schwinitz, Dr., 462.
 Schwöbbache, 148.
 Schwöbber, 151.
 Scipio Africanus, 1724.
 Sciron, or Cercyon, 2122.
 Sckell, Charles, 151.
 Sckell, Charles Louis, 151.
 Scone, 123.
 Scopoli, 1456.
 Scoresby, 2321.
 Scotswood Dean, 979.
 Scott, Mr. David, 333.
 Scott, Sir Walter, 22.
 Scottow Common, 1812.
 Scribonius Largus, 2418.
 Scudamore, Lord, 895.
 Scutari, 2467.
 Scythia, 941.
 Seafield, Earl of, 2165.
 Seckler, 895.
 Secondat, 1722.
 Seetsen, 1931.
 Seidlitz, Churchyard at, 2539.
 Selborne Churchyard, 2091.
 Sello, 1274.
 Seppings, Sir Robert, 620.
 Sepps, 190.
 Seringe, 694.
 Servius, 1956.
 Sesostris the Great, King of Egypt, 2408.
 Severa, Empress, 1351.
 Seville, 170, 1915.
 Sextius, 2070.
 Shadwell Lodge, 2048.

Shaftesbury, Countess of, 1317.
 Shakspere, 793.
 Shanes Castle, 1942.
 Shank Hill, 115.
 Shardeloes, 363.
 Sharfield, 1837.
 Sharp, Mr., South Lodge, 55.
 Shawley, 367.
 Sheffield, 130.
 Sheffield Park, 1778.
 Sheffield Place, 1783.
 Shelton, 1393.
 Shelton Abbey, 113.
 Shelton Park, 1957.
 Sheldon Woods, 2519.
 Shelford Lodge, 2000.
 Shelly, 2122.
 Shenstone, 1701.
 Shepore, 1146.
 Sheppard, 119.
 Shepherd, Mr. John, 1327.
 Sherrington, 489.
 Sherard, 239.
 Sherard, Dr. James, 75.
 Sherard, Dr. William, 75.
 Sherard, James, 62.
 Sheriff, Mr., 738.
 Sherwood, 277.
 Sherwood Forest, 1750.
 Shipley Hall, 1133.
 Shirley Street, 2280.
 Shooter's Hill, 839.
 Shoreditch, Duke of, 2086.
 Shortgrove, 2022.
 Shrewsbury, 1769.
 Shrivelsay, 2427.
 Shrubland Park, 2001.
 Si-ling-chi, Empress of China, 1350.
 Sibert's Abbey of Westminster, 1747.
 Sibthorp, Dr., 319.
 Sicily, 936.
 Sicker, Dr., 477.
 Sieber, 220.
 Siebold, Dr., 326.
 Siebold, M., 2095.
 Siebrub, 638.
 Siefertstraße, M., 155.
 Sienus, 1005.
 Simolius, 1648.
 Simond, M., 2471.
 Simpson, James, 918.
 Sims, Dr., 932.
 Sina, Baron, 147.
 Sinan Nile, 786.
 Sinclair, G., 1066.
 Sinclair, Mr., 773.
 Sinclair, Sir John, 329.
 Sinica, 276.
 Sir Gawaine, 1747.
 Sir Gerath, 1747.
 Sir Tristram, 1747.
 Siringur, 1115.
 Sirmore, 983.
 Sittingbourne, 696.
 Skechem, 1720.
 Skeensborough, 2118.
 Skeldale, 2073.
 Skene of Carriston, 20.
 Sketty Hall, 820.
 Slater, Gilbert, 83.
 Slater, John, 383.
 Slaugham Park, 2309.
 Sleford, 695.
 Sleave, Nance, 1591.
 Sloane, Sir Hans, 42.
 Sloane Square, 489.
 Slough, 1264.
 Sneathman, 1816.
 Smeaton's Eddystone Lighthouse, 1776.
 Smets, M., of Deurne, 1950.
 Smilax, 2084.
 Smith and Co., 47.
 Smith, Dr., of Christiania, 2241.
 Smith, Mr., Coombe Wood, 1154.
 Smith, Mr., Kew, 1922.

- Smith, W., Norbiton Common, 1147.
 Smith, Messrs., of Ayr, 2295.
 Smith, Robert, 2120.
 Smith, Sir J. E., 27. (and 84 other places).
 Smith, Sir Richard, 1392.
 Smith, Titus, 2191.
 Smithers, Mr., 1850.
 Smyrna, 674.
 Smyth, Sir S., 2184.
 Smyth, Thomas, 33.
 Snodgraas, Mr., 1809.
 Snowy Mountains, 2205.
 Society Isles, 1063.
 Socrates, 1720.
 Soesdyke, 41.
 Soissons, 1337.
 Solander, Dr., 83.
 Solinus, 92.
 Solitina, 2110.
 Solly, Richard Horsman, 357.
 Solomon, 15.
 Solomon's Temple, 940.
 Soma, or Somme, 169.
 Somerset Hall, 815.
 Somerset, Duke of, 1756.
 Somerset, Earl of, 793.
 Somerset, Edward Duke of, 73.
 Somme, Dr., 1951.
 Sophocles, 1794.
 Soulange-Bodin, M., 139.
 Sound of Mull, 2080.
 South Lodge, 1078.
 South Molton, 1854.
 South, Mr., 1762.
 South Runeton, 2580.
 Southampton, 131.
 Southcote, Mr., 71.
 Southend, 515.
 Southey, 512.
 Southfield, 1655.
 South Hill, 972.
 Southwell, Sir Thomas, 1430.
 Sowerby, Mr., 1489.
 Spach, M., 967.
 Spalatro, 697.
 Sparrow, Lady Olivia B., 1203.
 Speechley, 80.
 Spellman, Sir John, 24.
 Spence, Mr., 396.
 Spencer, Earl, 1336.
 Spenser, 677.
 Spiers, Alex., 1772.
 Spitalfields, 1461.
 Sprengel, 16.
 Springfield, 1861.
 Spring Gardens, 1393.
 Spring Grove, 254.
 Spring Vale, 112.
 Spruorrough Hall, 1394.
 St. Andrew's Square, Edinburgh, 1404.
 St. Anne's Hill, 687.
 St. Aubin-du-Perron, 1979.
 St. Augustine, Abbey of, 1347.
 St. Bartholomew, 839.
 St. Bartholomew's Chapel, Kingsland, 1777.
 St. Bernard, 2073.
 St. Catherine's Church, Regent's Park, 1748.
 St. Christopher, 1336.
 St. Clara, Convent of, at Bois le Duc, 2539.
 St. Claude, 1335.
 St. Denis, Paris, 815.
 St. Domingo, 621.
 St. Edmund, 1748.
 St. Etienne, 1961.
 St. Germain en Laye, 137.
 St. Helena, 579.
 St. Helen's, 1257.
 St. Innocent, Paris, 839.
 St. James, 839.
 St. James's Palace, 1769.
 St. James's Park, 506.
 St. John's College, Cambridge, 491.
 St. John's College, Oxford, 1392.
 St. Lawrence, 1057.
 St. Lawrence, Church of, 1776.
 St. Léger, 2057.
 St. Leonard's Forest, 1745.
 St. Leu, 138.
 St. Lo, 1390.
 St. Louis, 995.
 St. Lucie, 708.
 St. Martin-le-Pauvre, 2415.
 St. Mary's Isle, 290.
 St. Mary's, York, 2073.
 St. Médard, Bishop of Noyon, 792.
 St. Michael's Mount, 1903.
 St. Nicholas, Village of, 1965.
 St. Oeyth's, 1662.
 St. Peter, 792.
 St. Peter's, Jersey, 1064.
 St. Peter's, Rome, 2467.
 St. Petersburg, 984.
 St. Philip, 838.
 St. Pierre, 1006.
 St. Remy, 2471.
 St. Roque, 685.
 St. Sergius, Convent of, 2410.
 St. Sophia, 785.
 St. Stephen, Chapel of, 1747.
 St. Susan, Rome, 792.
 St. Tropez, 2228.
 Stackhouse, 16.
 Stackpole Court, 1237.
 Stæhelin, Benedict, 1064.
 Stæhelin, John Andrew, 1064.
 Stafford, 1667.
 Stallens, 2076.
 Stallings, Master Wm., 1353.
 Stamford, 1970.
 Stamford Hill, 959.
 Standish, 885.
 Standish, Arthur, 1751.
 Stanhope, Earl, 1838.
 Stanhope, Lord, 619.
 Stanmore, 2457.
 Stanmore Heath, 997.
 Stanmore Priory, 1861.
 Stanstead, 2072.
 Stanstead Forest, 1957.
 Stanstead Park, 1957.
 Stanwick Park, 2185.
 Stapleton Park, 1771.
 Starke, Rev. Mr., 1601.
 Staunton, Sir George, 84.
 Staunton, Sir G. T., 1509.
 Steel, 1464.
 Steiler, 1133.
 Stephens, Mr., 838.
 Stephens, Mr., of Elgin, 1978.
 Sterne, 1643.
 Stewart, Sir Henry, 105.
 Steven, Mr., 159.
 Steven, J., 1228.
 Stevenston, 1644.
 Stevenstone Park, 1837.
 Stewart, Dugald, 1663.
 Stewart, John, Earl of Bute, 378.
 Stewart, Sir M. S., 1225.
 Stidolph, Sir Richard, 1427.
 Stillingfleet, Mr. B., 1332.
 Stockbridge, 1758.
 Stockholm, 154.
 Stockholm Government Garden, 1325.
 Stoke Edith, 290.
 Stoke Edith Park, 716.
 Stoke Gabriel Churchyard, 2091.
 Stoke Pogis, 1976.
 Stoneleigh, 1779.
 Stoneleigh Abbey, 1771.
 Sourhead, 718.
 Stow Hill, 1519.
 Stow in the Wold, 2585.
 Stow, 70.
 Strabo, 1426.
 Strangways, Hon. F., 2232.
 Strasburg, 140.
 Stratford-le-Bow, 1864.
 Stratford-on-Avon, 1396.
 Strath Oikell, 1746.
 Strath Tay, 769.
 Strathfieldsaye, 71.
 Strathpey, 1115.
 Straton Strawless, 1783.
 Stretty Hall, 1840.
 Strickland, Wm., 2199.
 Stringer, Mr., 1519.
 Ström, M., 156.
 Stroudhouse, 1331.
 Stroudwater Hills, 1956.
 Strutt, Mr., 208. (and 35 other places).
 Stuart, the late Rev. Dr., 1546.
 Stubber, Robert, 840.
 Studley, 2151.
 Studley Park, 1394.
 Stukely, Dr., 1788.
 Sturge, G., 1804.
 Stutton Rectory, 2338.
 Suabia, 2143.
 Sudbury, 69.
 Suembo, 1115.
 Suidas, 1723.
 Sutherland, 48.
 Sutherland, Mr. James, 86.
 Sutton Churchyard, 2091.
 Sutton Place, Surrey, 1022.
 Swainson, Mr. William, 75.
 Swallowfield, 720.
 Swarts, 523.
 Swayne, Rev. G., 2027.
 Sweet, 316.
 Sweet Springs, 1166.
 Sweetheart Abbey, 1222.
 Swift, 57.
 Swinburne, 2020.
 Swinhoe, 47.
 Switzer, 54.
 Sydenham, 596.
 Sydney, 186.
 Sydney, M. J. F., 1006.
 Sydney, Sir Philip, 1763.
 Syon, 7. (and 126 other places).
 Syon Hill, 1018.
 Symes and Co., Messrs., 2395.
 Symonds, Dr., 897.
 Syracuse, 2038.
- T.
- Tabernaemontanus, 2063.
 Table Mountain, 2199.
 Tabley Hall, 1904.
 Tadoussac, 142.
 Tæssa, 786.
 Talbot, C. P., 1298.
 Talcaguane, 2436.
 Tampico, 1012.
 Tangier, 2407.
 Tankerville, Lady, 394.
 Taplow Court, 984.
 Tarascon, 140.
 Tarentum, 2228.
 Tarma, 2590.
 Tarnawa, 1725.
 Tarnawa Castle, 509.
 Tarring, 1367.
 Tasso, 1958.
 Tate, 1150.
 Taurida Palace, 1517.
 Taverham, 611.
 Taygetus, 2303.
 Taylor, Dr., 1976.
 Taylor, Samuel, 1424.
 Taylor, R. C., 2137.
 Taylure, C., 1073.
 Taymilt, 769.
 Taymouth, 82.
 Taymouth Castle, 371. (and 25 other places).
 Tassetti, M. Targioni, 2104.
 Tchitchagoff, Admiral, 139.
 Teidesley, 410.
 Teidesley Park, 2001.
 Teedale, 747.
 Tefis, 623.

- Telamon, 1643.
 Tell, William, 2070.
 Temple Gardens, 793.
 Temple House, 461.
 Temple of Bacchus, Pain's Hill, 2313.
 Temple of Philosophy, 1704.
 Temple, Sir Wm., 2021.
 Templeton, John, 106.
 Templeton, Mr., 1591.
 Templeton, Mrs., 112.
 Teneriffe, 2262.
 Tennessee, 1041.
 Tenore, Sr., of Naples, 420.
 Terenure, 275. (and 32 other places).
 Tereas, 1719.
 Terminus, 1780.
 Terni, 747.
 Tertullian, 785.
 Testwood, 624.
 Teta, Antonio, 504.
 Tent, 1725.
 Tentates, 1023.
 Tew Park, 1227.
 Tewksbury, 1393.
 Thainston, 266.
 Thames Ditton, 882.
 Thanet, 1376.
 Thanet, Earl of, 1812.
 Thasos, 2213.
 Thebes, 1005.
 Theobald's, 1353.
 Theocritus, 947.
 Theophilus, 792.
 Theophrastus, 16. (and 37 other places).
 Theseus, 2122.
 Thessaly, 693.
 Thevenot, 2410.
 Thirkleby near Thrisk, 2184.
 Thisbe, 1344.
 Thoburn, Mr., 71.
 Thornburn, Frank, 120.
 Thompson, 485.
 Thompson, Dr., 1188.
 Thompson, Mile End, 267.
 Thompson, Mr., 958.
 Thompson, R., 688.
 Thomason, John, 87.
 Thorauz, 2364.
 Thore, Dr., 2214.
 Thoresby, 2001.
 Thorndon Hall, 58.
 Thorp, 1904.
 Thorpe, 1490.
 Thory, 742.
 Thouin, Professor, 83.
 Thouse, M., 155.
 Thrace, 1016.
 Threlkeld, 27.
 Thrickleby Hall, 371.
 Througham, 1760.
 Thucydides, 2465.
 Thunberg, 222.
 Thurston, Archbishop of York, 2073.
 Thury, 138.
 Tibberton Court, 1815.
 Tibberton Park, 1745.
 Tiberius Caesar, 1987.
 Tiberius, Emperor, 882.
 Tibullus, 1958.
 Tibur, 1901.
 Tiburtus, 515.
 Tilburg, 2539.
 Timor, 2269.
 Tiny Park, 1977.
 Tipping, Mr., 2139.
 Tir Flood, 2301.
 Tisbury Churchyard, Dorset, 2076.
 Titsey Place, Godstone, 646.
 Tiltour, Mount Kennedy, 2120.
 Tivoli, 1033.
 Tivoli Garden, Vienna, 1665.
 Tixtala, 1949.
 Tocat, 1847.
 Toepflts, 150.
 Tolcross, 104.
 Tollymore Park, 108.
 Tongue, 571.
 Tonnan, 1507.
 Topham, —, of Windsor, 62.
 Tor Hill, 350.
 Tor Wood, 1773.
 Tornea, 2139.
 Torrens, Benjamin, 1314.
 Torrey, Dr., 480.
 Torrington, 1746.
 Tors, 1756.
 Tortworth, 24.
 Touch, 1402.
 Toulon, 140.
 Tournay, 145.
 Tournfort, 136. (and 23 other places).
 Tours, 689.
 Touthill Street, 692.
 Toward Castle, 421.
 Toward, Mr., 1178.
 Towers, Mr., 738.
 Tradescant, 36.
 Tradescant, J., jun., 49.
 Tragus, 1266.
 Traherne, Rev. J. M., 1839.
 Traill, Mr., 178.
 Trajan, Emperor, 1748.
 Trapp, Dr., 1956.
 Trattinik, M., 1423.
 Traucat, François, 1362.
 Trebia, 1724.
 Trebisonde, 716.
 Tredgold, 1787.
 Tredegar House, 652.
 Tredegar Park, 1777.
 Trelawney, Henry, 62.
 Trelawney, Sir Harry, of Butthead, 52.
 Tremayne, J. H., 119.
 Tremblestown, 114.
 Trentham Hall, 290. (and 35 other places).
 Trenton, 2283.
 Trevelyan, W. C., 153.
 Treviranus, 1498.
 Trianon, 137.
 Trieste, 697.
 Trinity College, Cambridge, 368.
 Tripoli, 2407.
 Tristan, M., 2014.
 Trona, 162.
 Troughton Hall, 314.
 Trudaine, Daniel Charles, 2414.
 Trudaine de Montigny, 2414.
 Tschoudi, Baron, 138.
 Tucker, Mr., 1854.
 Tudor, Mary, 1391.
 Tuggie, Mistress, 963.
 Tulleries, 469.
 Tull, 101.
 Tullibodie, 466.
 Tulloch Castle, 1439.
 Tullyhally, 1178.
 Tullymore Park, 2338.
 Tunbridge, 1745.
 Tunbridge Wells, 750.
 Tunis, 1911.
 Turin, 1662.
 Turner, 24.
 Turner, Mr., Bury Bot. Gard., 1517.
 Turner, Robert, 1800.
 Turner, Spencer, 1922.
 Turner, Thos. and Geo., 1769.
 Turner, Thos., 1402.
 Turnham Green, 1527.
 Tusculum, 515.
 Tuser, 35, 865.
 Twanley, Miss, 932.
 Tweeddale, 93.
 Tweeddale, first Marquess of, 103.
 Twickenham, 878.
 Twickenham Ferry, 1779.
 Twickenham Park, 55.
 Twicknam, 682.
 Tycheus, 1643.
 Tytney, Earl, 42.
 Tynningham, 102. (and 29 other places).
 Tyre, 1351.
 Tyrrell, Sir Walter, 1761.
 Tytherly, 2073.
 Tzarsco Celo, 157.
 U.
 Ulm, 1210.
 Uliverton, 769.
 Ulysses, 835.
 Underwood, Mr., 116.
 Ungnad, David, 717.
 Upsal, 154.
 Upton, 394.
 Upton House, 71, 593.
 Uriaberg Mountains, 1083.
 Utrecht, 145.
 Uvedale, Dr., 48.
 Uxbridge, Lady, 1769.
 V.
 Vahl, 1229.
 Vaillant, 1032.
 Valcinnaca, 549.
 Valdivia, 2436.
 Vale of Derwent, 2023.
 Vale of Gloucester, 1393.
 Vale of Tombs, 1509.
 Vallancey, 901.
 Vallemont, Dr., 2020.
 Valley of Andorre, on the Sègre, 2188.
 Valley of Arresu, 2188.
 Valley of Dhoon, 1014.
 Valleyfield, 123.
 Vallianieri, M., 1910.
 Valmont de Bouare, 2089.
 Valmombrosan Apennine, 1968.
 Valparaiso, 993.
 Van Burgdorf, M., 1862.
 Van der Maelen, 2529.
 Vander Schott, M., 147.
 Van Moes, Dr., 802.
 Van Sieboldt, Dr., 2535.
 Vancouver, 1784.
 Vancouver, Captain, 2291.
 Vane, Sir F., Bart., 1777.
 Varenabé, 163.
 Varennes, 1579.
 Varennes de Fenille, 1467.
 Varin, M., 1212.
 Varrel, M., 2471.
 Varro, 835.
 Vatican, Rome, 515.
 Vatinius, 2112.
 Vauchuse, 1071.
 Vaud, 161.
 Vaughan, Sir Robert W., 1763.
 Vauquelin, M., 307.
 Veitch, 93.
 Veith, Mr., 1900.
 Veltre, 2039.
 Veltheim, Count, 148.
 Venetian, 368.
 Venice, 549.
 Venus, 791.
 Vere, Mr., 1317.
 Vergaud, M., 465.
 Vermlinden, Sir Cornelius, 2116.
 Vermont, 412.
 Verney, Sir Harry, 1839.
 Vernon, Henry, 2334.
 Vernon, Mr., 55.
 Verrières, 924.
 Versailles, 140.
 Verspriet, 45.
 Verthema, Ludovico, 786.
 Vertumnus, 1322.
 Verulam, 2040.
 Vespasian, 23.
 Vetiars, M. Marcellin, 2452.
 Villard, M., 2037.
 Vicar of Puddington, 1753.

- Vicar's Hill, 1761.
 Victor Jacquemont, 2451.
 Vieil-Harcourt, 2121.
 Vienna, 147.
 Viera, 2263.
 Vieusseaux, at Chatelaine, 163.
 Villa Farnese, Rome, 665.
 Villalpando, 1124.
 Villares, M., 163.
 Villars, 793.
 Villars Cotterets, 1397.
 Villars-en-Morin, 162.
 Ville d'Avry, 272.
 Villers, 625.
 Villers le Bacle, 1362.
 Vilmorin, M., 137.
 Vinadio, 744.
 Vining Mr., 97.
 Virgil, 21.
 Virgin Mary, 839.
 Virgin Mary, Monastery of, 2409.
 Virginia, 522.
 Vishnu, 792.
 Vitellius, Emperor, 544.
 Vitre, 1774.
 Vitruvius, 21.
 Voltaire, 163.
 Vomonia, 1829.
 Von Buch, 1624.
 Von Itner, 677.
 Von Josika, Baroness, 1210.
 Vortigern, 2086.
 Vriigny, 137.
 Vuunien, near the Necker, 2012.
- W.
- Wachtmeister, Count Trolle, 155.
 Wacton, 1747.
 Wade, Dr., 185.
 Wade, Mr., 1458.
 Wadie, Mr., 389.
 Wager, Sir Charles, 62.
 Wahlenberg, 1486.
 Wakefield Lodge, 290.
 Walcot Hall, 2778.
 Wales, Princess Dowager of, 54.
 Walker, Dr., 24. (and 39 other places).
 Wallace, 1772.
 Wallaton Hall, 1904.
 Walter, 1763.
 Wallich, Dr., 173. (and 33 other places).
 Wallis, John, 834.
 Walls, Mr., 2185.
 Walpole, Sir Robert, 61.
 Walsh, Dr., 172.
 Walshford Bridge, 1771.
 Walsingham, 1763.
 Walsingham, Lady, 1732.
 Walter, John, 1782.
 Walter, Thomas, 120.
 Walter, Mr., 2512.
 Waltham Abbey, 244.
 Walthamstow, 772.
 Walther, 1872.
 Walton, 918.
 Walton House, 270.
 Walton, Lord Tankerville's, 71.
 Walton upon Thames, 373.
 Wangenheim, 1870.
 Warberg, 870.
 Warblington Churchyard, 2092.
 Warburton, 485.
 Waré, 2485.
 Ward, Mr., 128.
 Ward, Mrs., 113.
 Wardershare, 2000.
 Wardour Castle, 230.
 Wares, M., 155.
 Waring, Mr., 2087.
 Warminster, 2168.
 Warner, Henry Lee, 1815.
 Warner, Mr., 882.
 Warnsworth Hall, 1842.
 Warrington, 1458.
- Warsaw, 159.
 Warwick Castle, 1003.
 Wasbotten, 2302.
 Washington, 192.
 Water Walk, Magdalen College, Oxford, 1767.
 Waterbeach, 1524.
 Waterer, Mr., 1136.
 Waterford, 500.
 Watson, 150.
 Watson, Dr. Sir William, 40.
 Watts, 74.
 Watts, Mr., 2413.
 Weare Gifford, 1758.
 Webb, Captain W. S., 2344.
 Webb, Philip Barker, 119.
 Webb, Philip Carteret, 73.
 Webb and Berthelot, 1914.
 Webster, Mr., 1800.
 Webster, J., 1732.
 Wedgenock Park, 1770.
 Weihe and Nees von Eesenbeck, 734.
 Weimar, 2060.
 Weimar, Grand Duke of, 1488.
 Weir, James, 104.
 Weir, John, 104.
 Welbank, Captain, 385.
 Welbeck, 2384.
 Welbeck Abbey, 1849.
 Welbeck, Duke of Portland's Park at, 1765.
 Weld, Isaac, 1903.
 Wellington, Duke of, 1317.
 Wells, W., 1172-4.
 Wemyss Castle, 1226.
 Wendland, M., 151.
 Wendland, 298.
 Wentworth House, 1644.
 Werneck, M., 418.
 West, Counsellor, 114.
 West Dean, 275.
 West Felton, 2062.
 West Ham, 1453.
 West, Mr., 58.
 West Pleau, 716.
 Westbury, 1967.
 Western Isles of Shiant, 1115.
 Westminster Abbey, 1747.
 Westminster Hall, 1777.
 Westminster Palace, 1363.
 Weston, 80.
 Weston Lodge, 1764.
 Weston, Sir Richard, 787.
 Westwick House, 2219.
 Westwood, J. O., 1482.
 Weymouth, Lord, 2282.
 Whately, Mr., 1331.
 Whatton House, 1227.
 Wheeler, 80.
 Wheeler, Sir George, Bart., 400.
 Whim, 2297.
 Whinfield Park, 1771.
 Whitaker, Mr., 21.
 White, 1819.
 White, Gilbert, 1758.
 White Hart, 1761.
 White Hart Forest, 1758.
 White Hills, 1115.
 White, J., 2197.
 White Knights, 265. (and 84 other places).
 White, Mr., 2294.
 White, Thomas, 2359.
 White of Selborne, 2066.
 White, T. H., 25.
 White, Thomas, 2373.
 Whitehall, 787.
 Whitlaw, Mr., 2068.
 Whitley, 119.
 Whitley Abbey, 266.
 Whitstable, 367.
 Whittinghame, 1226.
 Whitton, 294. (and 41 other places).
 Whitton Place, Twickenham, 1837.
 Wiborg, Professor, 2089.
 Wicklow, Earl of, 113.
 Wickström, Dr., 1593.
- Wiffen, J. W., 1753.
 Wight of Ormiston, 103.
 Wilcock, Sir Henry, 813.
 Wilderness Blair, 540.
 Wilhelm, 2143.
 Wilhemshöhe, 148.
 Wilkesborough, 2312.
 Wilkeworth, 1527.
 Willdenow, 189. (and 35 other places).
 Wilmet, C. L., 542.
 Willey Park, 1190.
 William III., 61.
 William of Waynfleet, 1768.
 William Rufus, 1750.
 William the Conqueror, 1719.
 Williams, Mr., Pitmaston, 1209.
 Williams, E. A., 57.
 Williams, Rev. T., 430.
 Williams, Wm., 1840.
 Williamson, 2028.
 Willie, 1754.
 Willows, 963.
 Wilmington, 1884.
 Wilmington, Lord, 62.
 Willmot, 49.
 Willna, 410.
 Wilson, 85.
 Wilson, Mr., 831.
 Wilson, Professor, 1701.
 Wilson, 62.
 Wilson House, 1905.
 Withlire Downs, 2168.
 Wimbush, 1784.
 Wimbledon, 636.
 Wimbledon Common, 997.
 Wimbledon House, 1133.
 Wimpole, 841.
 Winch, 237.
 Winchester, 1761.
 Winchester, Virginia, 1143.
 Winchester, Bishop of, 622.
 Windsor, 1395.
 Windsor Castle, 369.
 Windsor Forest, 1754.
 Windsor, Vermont, 423.
 Windaton, 2118.
 Winter, 256.
 Winton, 2000.
 Winwick Hall, 1840.
 Wirttemberg, 372.
 Wirttemberg, Duke of, 2102.
 Wirtzberg, 1732.
 Wise, Henry, 46.
 Wistar, Caspar, 647.
 Wistman's, or Welchman's, Wood, 1757.
 Witham, 1262.
 Withering, Dr., 686.
 Wythermarsh Green, 700.
 Withers, W., 612.
 Withy Park, 1778.
 Wtiser, 2358.
 Woburn Abbey, 1457. (and 108 other places).
 Woburn Farm, 70.
 Woburn Park, 2183.
 Wohlgemuth, 1336.
 Woking, 1747.
 Wolf, 699.
 Wollaston, Dr., 1973.
 Wolsey, Cardinal, 2466.
 Wolstonecroft, Mary, 2304.
 Wolverton Hall, 230.
 Wood, 40.
 Wood, Hugh, 104.
 Wood, John, 1404.
 Woodfield, 383.
 Woodford, 1468.
 Woodhall, 389.
 Woodhouse Lee, 515.
 Woodlands, 815.
 Woodlands, New Forest, 1796.
 Woods, 168.
 Woods, Joseph, 790.
 Woods, Mr., of Cumberwell, 387.
 Woods, Mr. Maresfield, 757.

- Woodside, near Hatfield, 2309.
 Woodstock, 1683.
 Woodstock, Kilkenny, 427.
 Woodthorpe, 1841.
 Woodville, 485.
 Woodward, 1223.
 Woolgar, Mr., 1458.
 Woolington, 419.
 Woolwich, 1750.
 Woolwich Dockyard, 2382.
 Wooton, 45.
 Wootton, 1755.
 Wootton, Lady, Canterbury, 2586.
 Wootton, Lord, 40.
 Wordsworth, 1255.
 Worksop Manor, 1978.
 Worksop Park, 1767.
 Wörlitz, 148. (and 44 other places).
 Wormleybury, 254.
 Worthing, 963.
 Woronzow, Count, 159.
 Wrench of Fulham, 506.
 Wrightson, Hon. Mrs., 1842.
- Writtle Park, 1639.
 Wrottesley Hall, 2427.
 Wrottesley House, 841.
 Wroxton, 2072.
 Wroxton Abbey, 1219.
 Wyndham, Mr., of Felbrigg, 1989.
- X.
- Xalapa, 1132.
 Xenophon, 1132.
 Xerxes, 2037.
- Y.
- Yardley Chase, 1764.
 Yardley Lodge, 1764.
 Yair, 1226.
 Yalomensk, Palace of, 625.
 Yarmouth, 1325.
 Yates, Rev. Richard, 1783.
 Yester, 419.
 Yew Tree Island, 2080.
 Yvetot, 1774.
 York, 131.
 York, Duke of, 96.
- York House, Twickenham, 455.
 Youghall, 963.
 Young, Arthur, 1226.
 Young, Dr., 288.
 Young, Mr., 114.
 Young, James, of Pittfour, 2386.
 Young, William, 83.
 Young, Messrs., Spaon, 386.
- Z.
- Zaccheus, 418.
 Zara, 697.
 Zeb, 792.
 Zecher, 1486.
 Zein ool Kuddul Bridge in Ladhak, 2431.
 Zenobia, Queen of Palmyra, 110.
 Zenool Abudeen, 2430.
 Zeyer, M., 153.
 Zollingen, 162.
 Zoroaster, 512.
 Zug, 2538.
 Zurich, 161.

END OF THE FOURTH VOLUME.





